



# MAST.SH-GERMANY



## SURGICAL INSTRUMENTS CATALOGUE



### **Head Office:**

Pacca Garha, Kashmir Rd Sialkot -  
51310, Pakistan

Ph: +92 324 8609456

[www.mastpaksurgicalcorp.com](http://www.mastpaksurgicalcorp.com)

[info@mastpaksurgicalcorp.com](mailto:info@mastpaksurgicalcorp.com)

### **Germany Office:**

Hejri-shojaie, Melatengurtel-10  
50933-Koln, Germany

Ph: +49 178 8888815

[www.mast.sh-germany.com](http://www.mast.sh-germany.com)

[siroustalesh@yahoo.de](mailto:siroustalesh@yahoo.de)



Stethoskope  
Stethoscopes  
Estetoscopios  
Stetoscopi

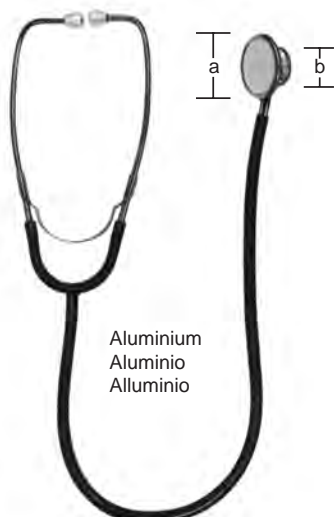

Aluminium  
Aluminio  
Alluminio

DUPLEX

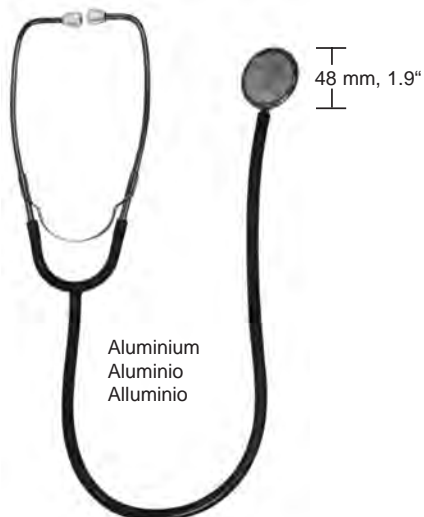

Aluminium  
Aluminio  
Alluminio

ANESTOPHON  
03248-00

	a	b	
03246-00	48 mm, 1.9"	30 mm, 1.2"	
03246-01	39 mm, 1.5"	25 mm, 1.0"	Baby
03246-02	21 mm, 0.8"	21 mm, 0.8"	Neonatal



PINARD  
03260-15 15 cm, 6"  
ALU



PINARD  
03262-18 18 cm, 7"

Holz, wood,  
madera, legno

Perkussionshämmer  
 Percussion Hammers  
 Martillos de percusión  
 Martelli da percussione



TAYLOR - USA Mod.  
 03288-17 17 cm, 6 3/4"  
 03288-20 20 cm, 8"



BABINSKY  
 03292-22 22 cm, 8 3/4"



TROEMNER  
 03294-24 24 cm, 9 1/2"



DEJERINE  
 03304-20 20 cm, 8"



BERLINER  
 03306-17 17 cm, 6 3/4"



BUCK  
 03308-18 18 cm, 7"



Prüf- und Meßinstrumente  
Examination and Measuring Instruments  
Instrumentos para exámenes y medidas  
Strumenti per esaminare e misurare

Dynamometer  
Dynamometer  
Dinamómetro  
Dinamometro



COLLIN  
03310-01 Erwachsene, Adult,  
adultos, adulti  
03310-02 Kind, child, niños, bambini

Winkelmesser  
Goniometer  
Goniómetro  
Goniometro



MOELTGEN  
03312-01



Finger-Goniometer  
Finger goniometer  
Goniómetro para dedos  
Goniometro per le dita  
03314-01



WARTENBERG  
03320-19 19 cm, 7 1/2"



aus Stahl  
of steel  
de acero  
di acciaio  
03350-15 1,5 m 0.6"



Metall  
03340-10 10 cm 4"  
03340-15 15 cm 6"  
03340-20 20 cm 8"  
03340-30 30 cm 12"  
03340-50 50 cm 20"



Schieblehren  
Calipers  
Calibres  
Calibro

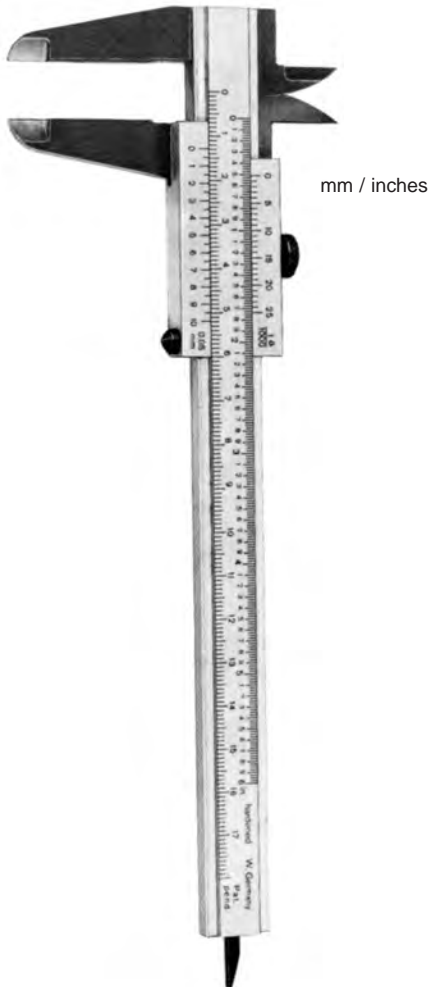

03360-21  
21 cm, 8 1/4"

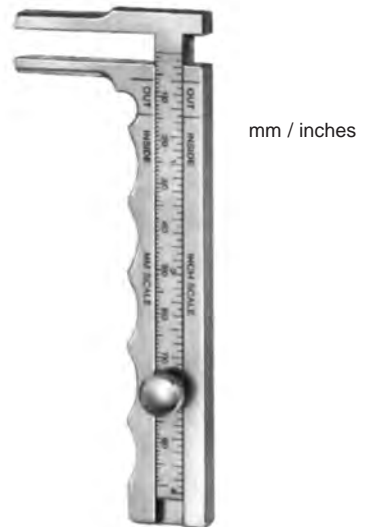

TOWNLEY  
03361-10  
11,5 cm, 4 1/2"



Saugrohre  
Suction tubes  
Tubos de aspiración  
Cannule per aspirazione



POOLE 20 cm, 8"  
05130-05 5.5 mm  $\varnothing$ , 0.2"  
(17 Fr.)

05130-10 10 mm  $\varnothing$ , 0.4"  
(30 Fr.)



POOLE 19 cm, 7 1/2"  
05140-05 5.5 mm  $\varnothing$ , 0.2"  
(17 Fr.)

05140-08 8 mm  $\varnothing$ , 0.3"  
(23 Fr.)



compl. BABY-YANKAUER  
05150-21 21 cm, 8 1/4"  
compl. YANKAUER  
05150-27 27 cm, 10 1/2"

Saugrohre  
Suction tubes  
Tubos de aspiración  
Cannule per aspirazione

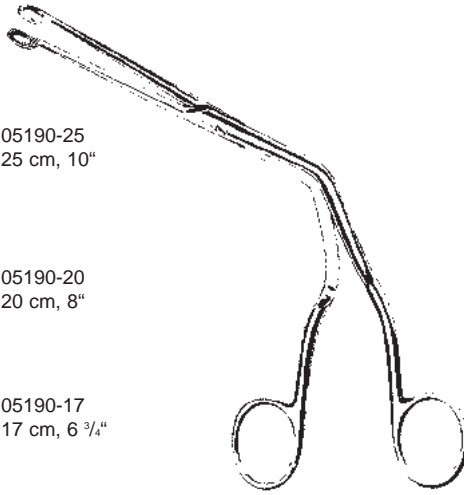
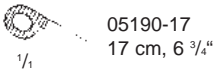
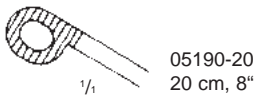
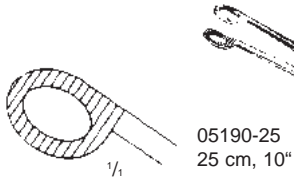

MAGILL



ANDREW-PYNCHON

05170-24  
6 mm ø, 1/2"  
24 cm  
9 1/2"



05160-01  
8 mm ø, 0.3" / 36  
cm, 14 1/4"  
Kaltlicht  
cold-light  
fria  
mit  
with  
con luz  
con luce fredda



COOLEY  
05160-02  
8 mm ø, 0.3"  
36 cm  
14 1/4"



COOLEY  
05160-03  
8 mm ø, 0.3"  
30 cm  
11 3/4"



DE BAKHEY  
05160-04  
3 mm ø, 0.1"  
27 cm  
10 1/2"



McINTOSH

Fig. 0	5,5 cm	2 1/4"	05210-00
Fig. 1	7,5 cm	3"	05210-01
Fig. 2	9,0 cm	3 1/2"	05210-02
Fig. 3	11,0 cm	4 3/8"	05210-03
Fig. 4	13,5 cm	5 1/4"	05210-04

Cold light  
05211-00  
05211-01  
05211-02  
05211-03  
05211-04



05239-03  
Halogen-Lampe  
Halogen Lamp  
Lámpara Halógena  
Lampada Alogena



05239-01  
f./p. Fig. 0-1



05239-02  
f./p. Fig. 2-4



FOREGGER

Fig. 0	5,5 cm	2 1/4"	05220-00
Fig. 1	7,0 cm	2 3/4"	05220-01
Fig. 2	9,0 cm	3 1/2"	05220-02
Fig. 3	11,0 cm	4 3/8"	05220-03
Fig. 4	13,5 cm	5 1/4"	05220-04

Cold light  
05221-00  
05221-01  
05221-02  
05221-03  
05221-04



05239-03  
Halogen-Lampe  
Halogen Lamp  
Lámpara Halógena  
Lampada Alogena



05239-01  
f./p. Fig. 0-1



05239-02  
f./p. Fig. 2-4



Laryngoskope  
Laryngoscopes  
Laringoscopios  
Laringoscopi

**MILLER**



05230-00  
55 mm, 2.1/2"  
Nutzlänge  
working length  
largo útil  
lunghezza utile

für Säuglinge  
for babies  
para neonatales  
per neonati



05230-01  
80 mm, 3 1/8"  
Nutzlänge  
working length  
largo útil  
lunghezza utile

für Kinder  
for children  
para niños  
per bambini



05230-02  
130 mm, 5"  
Nutzlänge  
working length  
largo útil  
lunghezza utile

für Jugendliche  
for adolescents  
para adolescentes  
per adolescenti



05230-03  
170 mm, 6 3/4"  
Nutzlänge  
working length  
largo útil  
lunghezza utile

für Frauen  
for women  
para mujeres  
per donne



05230-04  
180 mm, 7"  
Nutzlänge  
working length  
largo útil  
lunghezza utile

für Männer  
for men  
para hombres  
per uomini



05239-01  
f./p. Fig. 0-1



05239-02  
f./p. Fig. 2-4



Laryngoskope  
Laryngoscopes  
Laringoscopios  
Laringoscopi



**McIntosh**

05203-00

Set bestehend aus:  
1 Etui  
1 Batteriegriff 05234-28  
3 Spatel (Fg. 2-4)

Set consisting of:  
1 Case  
1 Handle  
3 Blades (Fg. 2-4)

Juego compuesto de:  
1 Estuche  
1 Mango  
3 Hoja (Fg. 2-4)

Set composto da:  
1 Astuccio  
1 Manico  
3 Spatole (Fg. 2-4)

05204-00

Set bestehend aus:  
1 Etui  
1 Batteriegriff 05234-28  
4 Spatel (Fg. 1-4)

Set consisting of:  
1 Case  
1 Handle  
4 Blades (Fg. 1-4)

Juego compuesto de:  
1 Estuche  
1 Mango  
4 Hoja (Fg. 1-4)

Set composto da:  
1 Astuccio  
1 Manico  
4 Spatole (Fg. 1-4)



**Foregger**

05223-00

Set bestehend aus:  
1 Etui  
1 Batteriegriff 05234-28  
3 Spatel (Fg. 2-4)

Set consisting of:  
1 Case  
1 Handle  
3 Blades (Fg. 2-4)

Juego compuesto de:  
1 Estuche  
1 Mango  
3 Hoja (Fg. 2-4)

Set composto da:  
1 Astuccio  
1 Manico  
3 Spatole (Fg. 2-4)

05224-00

Set bestehend aus:  
1 Etui  
1 Batteriegriff 05234-28  
4 Spatel (Fg. 1-4)

Set consisting of:  
1 Case  
1 Handle  
4 Blades (Fg. 1-4)

Juego compuesto de:  
1 Estuche  
1 Mango  
4 Hoja (Fg. 1-4)

Set composto da:  
1 Astuccio  
1 Manico  
4 Spatole (Fg. 1-4)



Batteriegriffe, Warmlicht  
Battery handles, warm light  
Mango de pila, luz caliente  
Manico a batteria, luce calda



05233-18 18 mm ø, 3/4"



05234-28 28 mm ø, 1"  
05234-37 37 mm ø, 1 1/2"



05238-01 30 mm ø, 1 1/4"

Batteriegriffe, Kaltlicht  
Battery handles, cold light  
Mango de pila, luz fria  
Manico a batteria per luce fredda



05238-02  
18 mm ø  
3/4"



05238-03  
30 mm ø  
1 1/4"

Batteriegriffe, Warmlicht  
Battery handles, warm light  
Mango de pila, luz caliente  
Manico a batteria, luce calda



05240-30 30 mm  $\varnothing$ , 1 1/4"  
Griff mit Trafo-Anschluß  
Handle with Transformer-connection  
Mango con conexión al transformador  
Manico con connessione al trasformatore



05241-11 Trafo 110 V  
05241-22 Trafo 220 V

Trafo 110 Volt mit amerikanischem Netzanschluß  
Transformer 110 Volt with american mains connection  
Transformador 110 V con conexión americana  
Trasformatore 110 V ricarica batteria

Trafo 220 Volt mit 1,40 m (55") langem Kabel  
Transformer 220 Volt with cable 1,40 m (55") long  
Transformador, 220 V con cable de 1,40 m (55")  
Trasformatore 220 V ricarica batteria

Laryngoskope  
Laryngoscopes  
Laringoscopios  
Laringoscopi

Operation Laryngoskop:  
rostfreier Edelstahl  
Rohr: innen matt/außen glänzend  
Griff: ganz matt

Operation Laryngoscope:  
stainless steel  
tube: inner surface matt/outer  
surface polished  
handle: matt

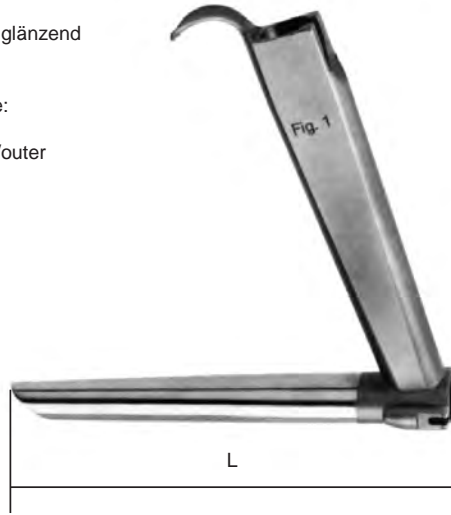

Laringoscopio para operaciones:  
Acero inoxidable  
Pala: Superficie interior: Mate  
Superficie exterior: Brillante  
Mango entero: Mate

Laringoscopio a luce  
fredda per microchirurgia  
endolaringeo  
tubo: interiore opaco – esterno lucido  
manico: opaco

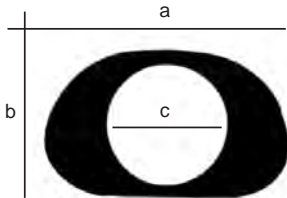

Nr.	L (mm)	a (mm)	b (mm)	c (mm)
05301-01	135	21,8	14,0	13,0
05301-02	152	22,5	14,8	13,0
05301-03	182	23,0	15,0	14,0
05301-04	172	29,5	18,0	17,0
05301-05	172	31,5	21,5	19,0

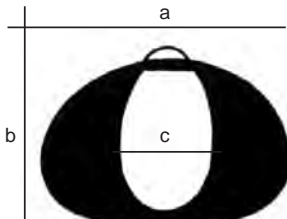

Nr.	L (mm)	a (mm)	b (mm)	c (mm)
05301-06	182	29,0	20,0	16,0 x 26,0
05301-07	222	29,0	20,0	16,0 x 26,0



Laryngoskope  
Laryngoscopes  
Laringoscopios  
Laringoscopi

05300-01/02 Bruststütze für Erwachsene/Kinder bestehend aus:  
05300-03 Stützstange für Erwachsene 34 cm / 05300-06 Ring / 05300-05 Gelenk  
05300-04 Stützstange für Kinder 24 cm / 05300-06 Ring / 05300-05 Gelenk  
05300-01/02 Chest Support for adults/children complete consisting of:  
05300-03 Support rod for adults 34 cm / 05300-06 Ring / 05300-05 Joint  
05300-04 Support rod for children 24 cm / 05300-06 Ring / 05300-05 Joint  
05300-01/02 Soporte pectoral para adultos/niños compuesto de:  
05300-03 para adultos 34 cm / 05300-06 / 05300-05  
05300-04 para niños 24 cm / 05300-06 / 05300-05  
05300-01/02 Braccio portalarinoscopio sternale per adulti/bambini composto da:  
05300-03 per adulti 34 cm / 05300-06 anello / 05300-05 giunto  
05300-04 per bambini 24 cm / 05300-06 anello / 05300-05 giunto

Operationslaryngoskop, Kleinsasser  
Operation laryngoscope, Kleinsasser  
Laringoscopios operativo, Kleinsasser  
Laringoscopio operativo, Kleinsasser

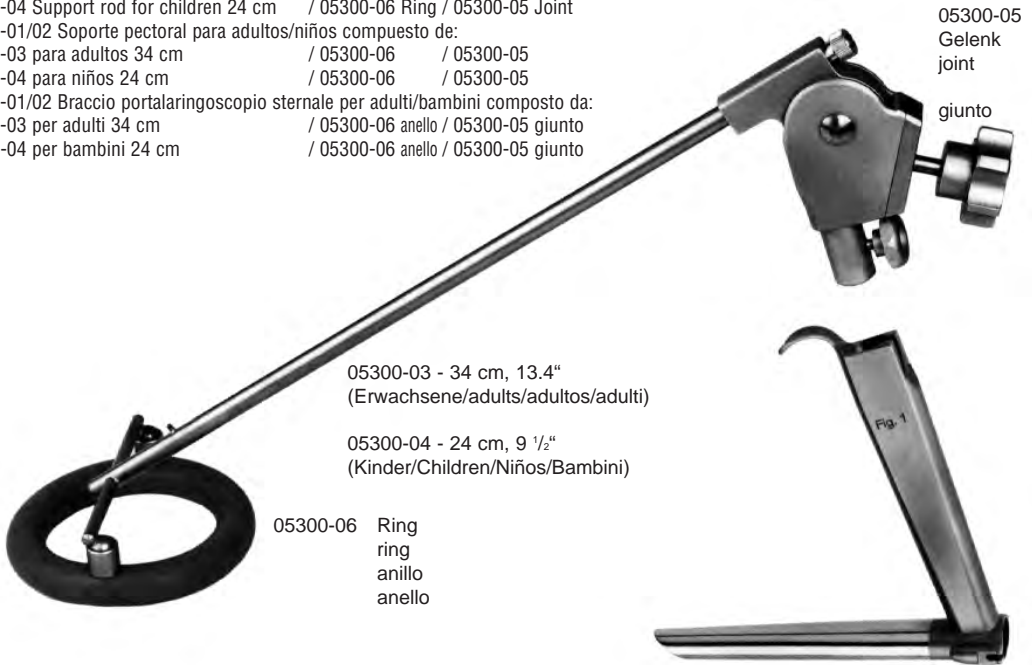

Fiberglas-Lichtträger – Fiberglas-light-guide –  
Portadore de luz fria – portatore di luce fredda  
a fibre di vetro

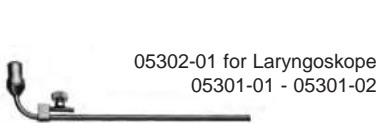

05303-01  
Injektionskanüle für Laryngoskope: 05301-01 - 05301-07  
Injetion drain tube for Laryngoscopes: 05301-01 - 05301-07  
Canúla de inyeccion para laringoscopios: 05301-01 - 05301-07  
Cannula da iniezione per laringoscopi: 05301-01 - 05301-07

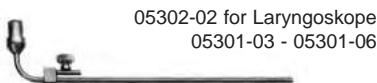

05304-01  
Rauchabsaugrohr für Laryngoskop:  
Suction tube for Laryngoscopes: 05301-03 - 05301-07  
Canúla de succion para laringoscopios: 05301-03 - 05301-07  
Tubo di aspirazione per laringoscopi: 05301-03 - 05301-07

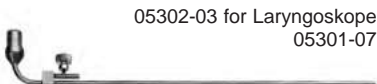



Laryngoskope  
Laryngoscopes  
Laringoscopios  
Laringoscopi

HOLINGER Laryngoskop  
HOLINGER Laryngoscope  
HOLINGER Laringoscopio  
HOLINGER Laringoscopi

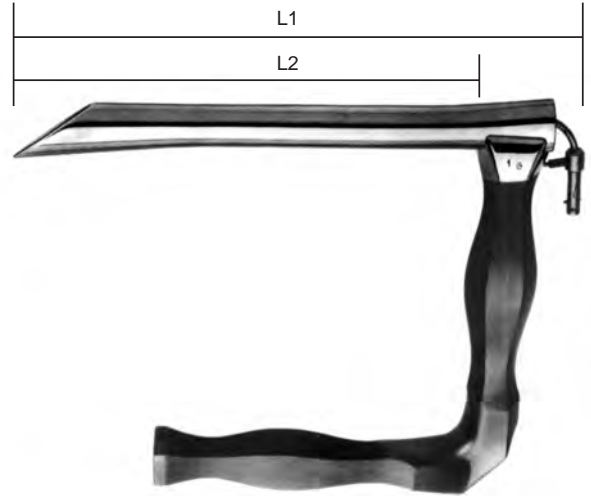

Nr.	L1	L2	Lichtträger light guide Portador de luz portatore di luce
05310-01	180 mm	157 mm	05311-01
05310-02	170 mm	146 mm	05311-02
05310-03	120 mm	98 mm	05311-03
05310-04	90 mm	77 mm	05311-04

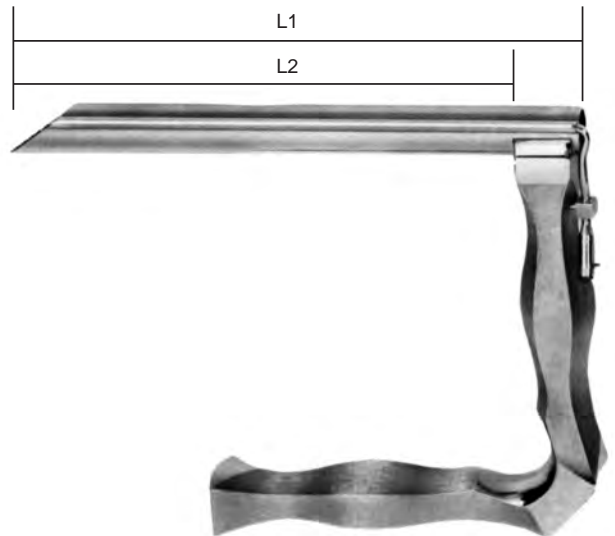

JACKSON Laryngoskop  
JACKSON Laryngoscope  
JACKSON Laringoscopio  
JACKSON Laringoscopi

Nr.	L1	L2	Außen-Dm Outer-dm dm-exterior dm-esterno	Innen-Dm Inner-dm dm-interior dm-interno	Lichtträger light guide Portador de luz portatore di luce
05320-01	160 mm	135 mm	17,5 mm	14,5 mm	05321-01
05320-02	160 mm	135 mm	14,5 mm	12,0 mm	05321-02
05320-03	120 mm	105 mm	14,0 mm	11,5 mm	05321-03
05320-04	90 mm	75 mm	13,0 mm	10,0 mm	05321-04



Skalpelli-Griffe  
 Scalpel Handles  
 Mangos de bisturíes  
 Manici per lama bisturi

passend zu den Klängen  
 for blades  
 para las hojas  
 per lama bisturi

(A) No. 10, 11, 12, 13, 14, 15, 16, 17, 18, 19

(B) No. 20, 21, 22, 23, 24, 25



07103-00

Fig. 3

(A)



07103-01

Fig. 3 grad.

(A)



07103-02

Fig. 3 L

(A)

Skalpell-Griffe  
Scalpel Handles  
Mangos de bisturías  
Manici per lama bisturi



07104-00

Fig. 4

(B)



07104-02

Fig. 4 L

(B)



07105-02

Fig. 4 L

(B)



**MAST.SH-GERMANY**

Skalpell-Griffe  
Scalpel Handles  
Mangos de bisturíes  
Manici per lama bisturi



07106-01  
14,5 cm 5 3/4"

(A)



07106-02  
14 cm 5 1/2"

(A)

Skalpelli-Griffe  
Scalpel Handles  
Mangos de bisturíes  
Manici per lama bisturi



07107-00  
Fig. 7  
Ⓐ



07107-01  
Fig. 7K  
Ⓐ



07107-03  
Ⓐ



07107-04  
Ⓐ

Skalpell-Griffe  
Scalpel Handles  
Mangos de bisturíes  
Manici per lama bisturi



07108-00  
Fig. 8

(B)



07109-03  
Fig. 3 L

(A)

Skalpell-Griffe  
Scalpel Handles  
Mangos de bisturíes  
Manici per lama bisturi



07161-00 07162-00 07165-00 07167-00

Packung mit 10 Stück  
box of 10  
en cajas de 10 pzas  
confezione di 10

07109-10 10,0 cm, 4"  
07109-13 13,0 cm, 5"  
07109-15 15,5 cm, 6"



Skalpelli-Klingen, Steril  
Scalpel Blades, Sterile  
Hojas de bisturí, estéril  
Lame per bisturi, sterili



07110-00



07111-00



07112-00



07113-00



07115-00



07116-00



07118-00



07119-00



07120-00

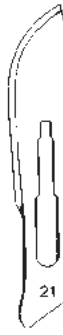

07121-00



07122-00



07123-00



07124-00



07125-00



**MAST.SH-GERMANY**

Einmal-Skalpelle, Steril  
Disposable Scalpels, Sterile  
Bisturíes uso único, estériles  
Bisturi monouso, sterili



07210-00

Packung mit 10 Stück  
in packages of 10 each  
en cajas de 10 c/u  
confezione di 10 pezzi



07211-00



07212-00



07213-00



07215-00



07218-00



07219-00



07220-00



07222-00



07224-00



07225-00



Amputationsmesser  
Amputation Knives  
Cuchillos para amputaciòn  
Coltelli per amputazione

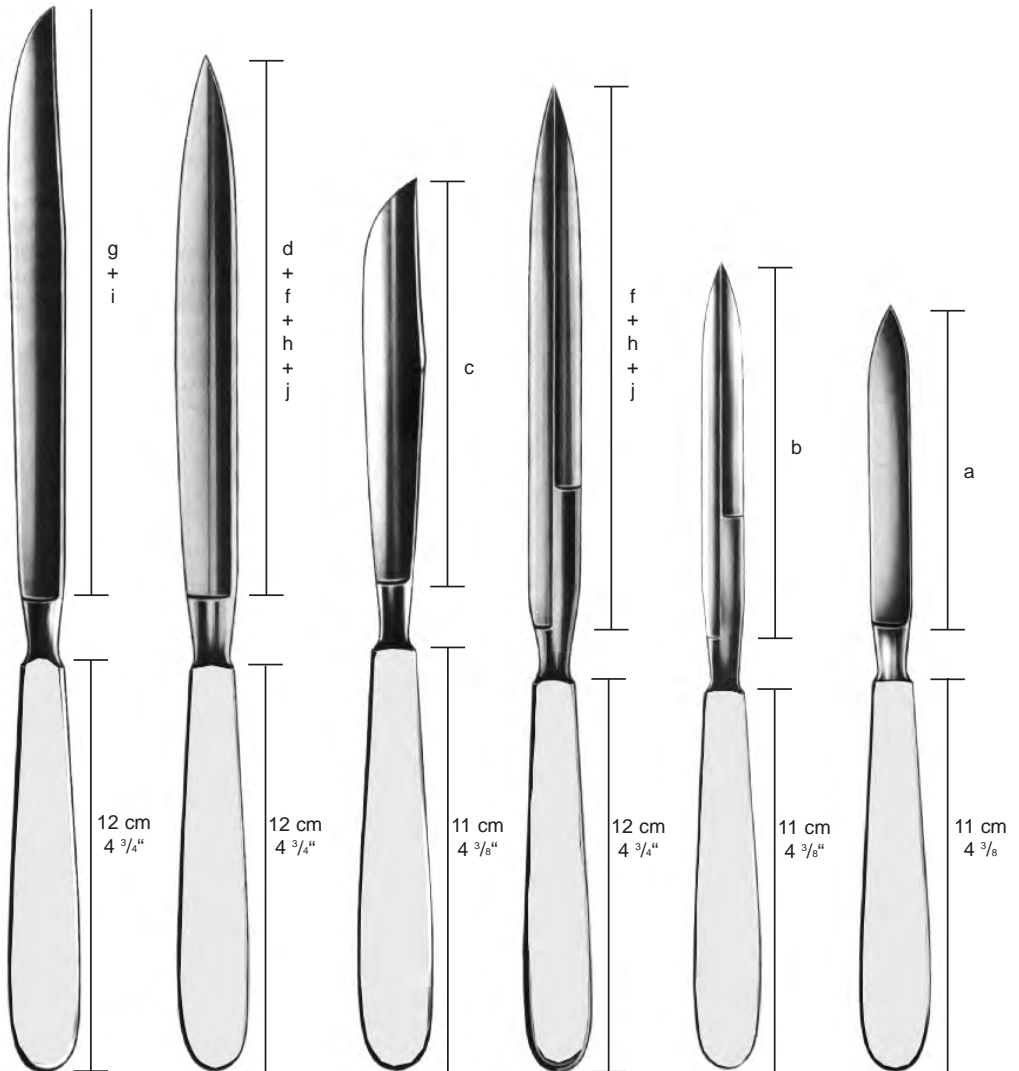

Liston  
07200-17  
07200-20

Reda  
07201-13  
07201-16  
07201-19  
07201-22

Langenbeck  
07202-12

Catlin  
doppelschneidig  
double  
aftingedeges  
filo doble  
doppio taglio  
07203-16  
07203-19  
07203-22

07204-11

Zwischenknochen-  
messer doppel-  
schneidig  
Inerosseous knife  
double aftingedeges  
Cuchillo interóseo  
filo doble  
Coltello interosseo  
doppio taglio

07205-09

Phalangen-  
messer  
Phalangeal knife  
Cuchillos para  
falanges  
Coltello per falangi

Schnittlänge  
Length of blades  
Largo de hojas  
Lunghesse delle lame

a - 9,5 cm	c - 12,0 cm	e - 15,0 cm	g - 17,0 cm	i - 20,0 cm
b - 11,0 cm	d - 13,0 cm	f - 16,0 cm	h - 19,0 cm	j - 22,0 cm
a - 3 3/4"	c - 4 3/4"	e - 6"	g - 6 3/4"	i - 8"
b - 4 3/8"	d - 5"	f - 6 1/4"	h - 7 1/2"	j - 8 3/4"

Klingenbrecher, Rasierklingen  
 Blade Breakers, Razor Blades  
 Rompe-hojas, hojas de afeitar  
 Lama di rasoio, Rompilamette



TROUTMAN-CHRIS  
 07290-09 9 cm, 3 1/2"



REDA  
 07291-11 11 cm, 4 3/8"



CASTROVIEJO  
 07294-13 13 cm, 5 1/8"

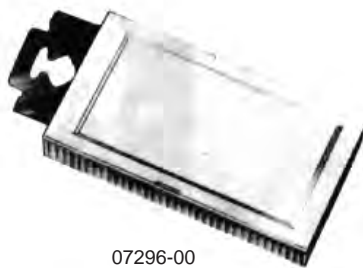

07296-00

Packung = 10 Stück  
 package = 10 each  
 caja = 10 c/u  
 confezione = 10 pezzi

Skalpelle mit Metallheft  
 Scalpels with Metal Handle  
 Bisturíes, mango metálico  
 Bisturi, manico di metallo



Fig. 1  
 07402-01  
 15 cm, 6"  
 30 mm, 1.2"

Fig. 2  
 07402-02  
 15 cm, 6"  
 36 mm, 1.4"

Fig. 3  
 07402-03  
 15,5 cm, 6"  
 40 mm, 1 1/2"

Fig. 4  
 07402-04  
 16 cm, 6 1/4"  
 45 mm, 1 3/4"

Fig. 5  
 07402-05  
 16 cm, 6 1/4"  
 50 mm, 2"



Fig. 6  
 07402-06  
 15 cm, 6"  
 27 mm, 1"

Fig. 7  
 07402-07  
 15 cm, 6"  
 35 mm, 1.4"

Fig. 8  
 07402-08  
 16 cm, 6 1/4"  
 40 mm, 1 1/2"

Fig. 9  
 07402-09  
 16 cm, 6 1/4"  
 47 mm, 1.9"

Fig. 10  
 07402-10  
 17 cm, 6 3/4"  
 50 mm, 2"

Resektions- und Knorpelmesser  
 Resection and Cartilage Knives  
 Cuchillos para resección/cartilagos  
 Coltelli per resezione e cartilagini



19 cm, 7 1/2"

07403-01

Metallheft  
 metal handle  
 mango metálico  
 manico di metallo

Beinhautmesser  
 mit Schaber  
 Periosteum Knife  
 with raspatory  
 Cuchillo para  
 periostio, con  
 periostótamo  
 Coltello per  
 periostio con  
 raschino



19 cm, 7 1/2"

07403-02

Holzheft  
 wooden handle  
 mango de madera  
 manico in legno



18 cm, 7"

07410-05  
 Langenbeck

07412-05



Sezier-, Hirn- und Organmesser  
 Autopsy- Brain- and Post mortem knives  
 Cuchillos para autopsia- cerebro- órganos  
 Coltelli per cartilagini- cervello e organi

Schnittlänge  
 Length of blades  
 Largo de hojas  
 Lunghezze delle lame

- a - 8,5 cm, 3,4"
- b - 9,5 cm, 3 3/4"
- c - 11,0 cm, 4 3/8"
- d - 14,0 cm, 5 1/2"
- e - 16,0 cm, 6 1/4"
- f - 17,0 cm, 6 3/4"
- g - 19,5 cm, 7 3/4"
- h - 20,0 cm, 8"
- i - 24,0 cm, 9 1/2"

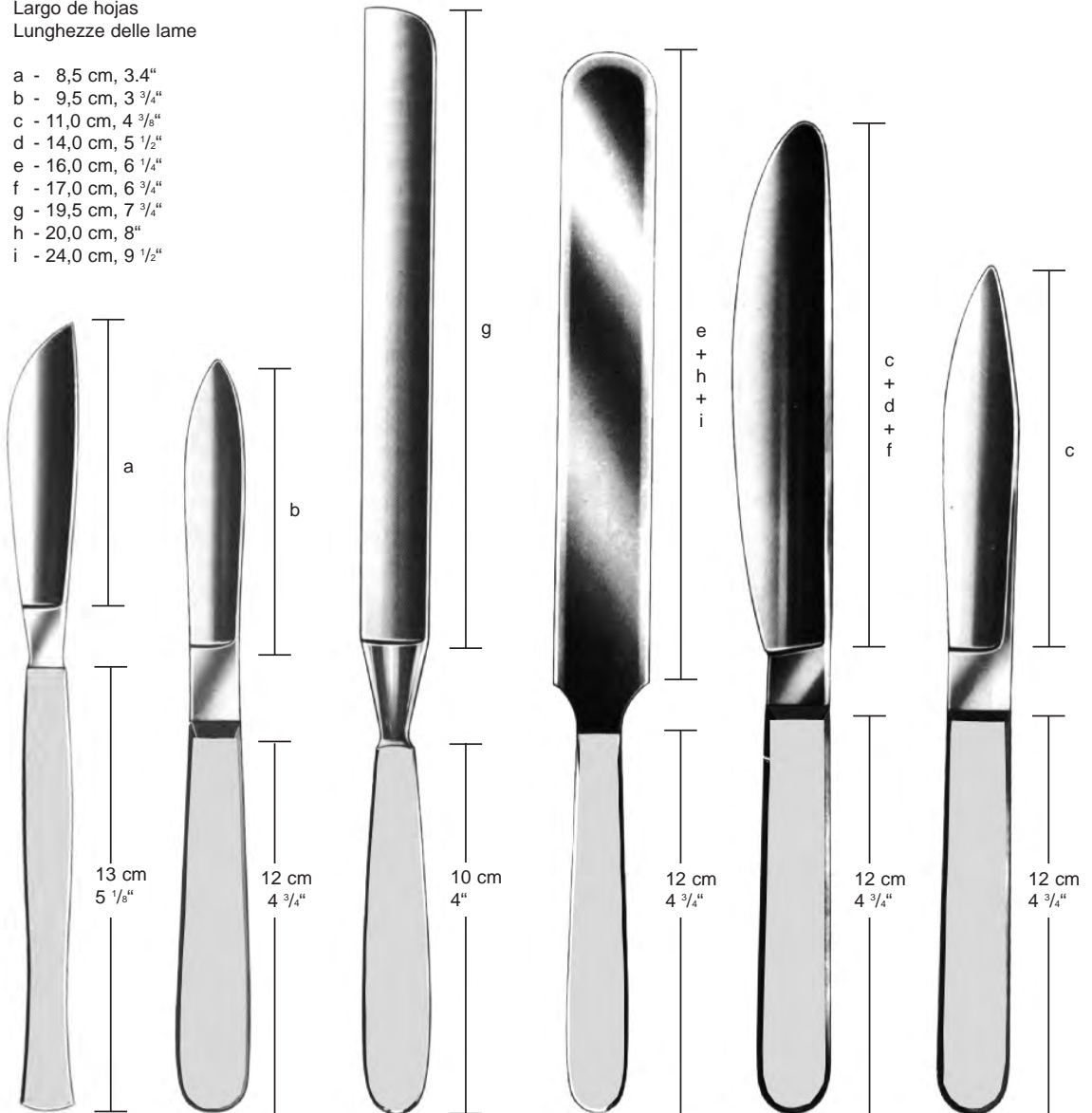

Virchow  
 07420-08

Virchow  
 07421-09

07422-19

Virchow  
 07423-16  
 07423-20  
 07423-24

07424-11  
 07424-14  
 07424-17

07425-11



**MAST.SH-GERMANY**

Dermatome, Rasiermesser  
Dermatome, Razor  
Dermátomo, Navajas  
Dermatomo, Rasoio



SCHINK  
07490-00  
30 cm, 11 3/4"  
0,1 - 2 mm  
compl.  
mit/with/con

07490-01 (1) Stk./ pcs/ pzas  
07490-02 (2) Stk./ pcs/ pzas



07490-01  
Ersatzklinge  
Spare blade  
Hoja de repuesto  
Lama di ricambio per dermatomo

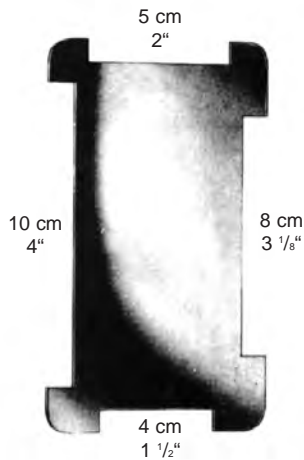

07490-02  
Spannplatte  
Skin straightening plate  
Placa para extender la piel  
Placca per stendipelle



07496-00  
Rasiermesser 8 cm, 3 1/8"  
Razors 8 cm, 3 1/8"  
Navajas 8 cm, 3 1/8"  
Rasoio 8 cm, 3 1/8"

Dermatome  
 Dermatome  
 Dermátomo  
 Dermatomo

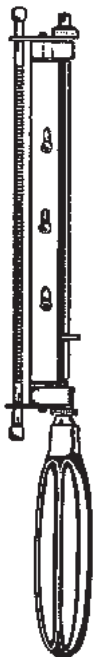

07496-31

Ersatzklingen  
 Spare blades pack  
 Hoja de repuesto  
 Lama di ricambio

**HUMBY**  
 07495-31 31 cm, 12 1/4"  
 0,1 - 1,2 mm



**SILVER**  
 07498-00  
 190 mm, 7 1/2"  
 Dermatom, ohne Klinge  
 Skin graft knife, without blade  
 Dermátomo sin hoja  
 Senza lama utilizzo con lamette  
 da barba normale



Klingen  
 blades  
 bisturi  
 07499-01

**WATSON**  
 07499-00  
 300 mm, 11 3/4"  
 Dermatom, ohne Klinge  
 Skin graft knife, without blade  
 Dermátomo sin hoja  
 Senza lama utilizzo con lamette  
 da barba normale

Chirurgische Scheren  
 Operating Scissors  
 Tijeras para cirugía  
 Forbici per chirurgia



STANDARD

- 09102-11 11,5 cm, 4 1/2"
- 09102-13 13,0 cm, 5"
- 09102-14 14,5 cm, 5 3/4"
- 09104-14 TC**
- 09102-15 15,5 cm, 6"
- 09102-16 16,5 cm, 6 1/2"
- 09102-18 18,5 cm, 7 1/4"
- 09102-20 20,0 cm, 8"



STANDARD

- 09110-11 11,5 cm, 4 1/2"
- 09110-13 13,0 cm, 5"
- 09110-14 14,5 cm, 5 3/4"
- 09114-14 TC**
- 09110-15 15,5 cm, 6"
- 09110-16 16,5 cm, 6 1/2"
- 09110-18 18,5 cm, 7 1/4"
- 09110-20 20,0 cm, 8"



STANDARD

- 09120-11 11,5 cm, 4 1/2"
- 09120-13 13,0 cm, 5"
- 09120-14 14,5 cm, 5 3/4"
- 09124-14 TC**
- 09120-15 15,5 cm, 6"
- 09120-16 16,5 cm, 6 1/2"
- 09120-18 18,5 cm, 7 1/4"
- 09120-20 20,0 cm, 8"



STANDARD

- 09103-11 11,5 cm, 4 1/2"
- 09103-13 13,0 cm, 5"
- 09103-14 14,5 cm, 5 3/4"
- 09105-14 TC**
- 09103-15 15,5 cm, 6"
- 09103-16 16,5 cm, 6 1/2"
- 09103-18 18,5 cm, 7 1/4"
- 09103-20 20,0 cm, 8"

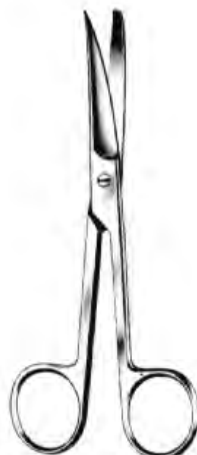

STANDARD

- 09111-11 11,5 cm, 4 1/2"
- 09111-13 13,0 cm, 5"
- 09111-14 14,5 cm, 5 3/4"
- 09115-14 TC**
- 09111-15 15,5 cm, 6"
- 09111-16 16,5 cm, 6 1/2"
- 09111-18 18,5 cm, 7 1/4"
- 09111-20 20,0 cm, 8"



STANDARD

- 09121-11 11,5 cm, 4 1/2"
- 09121-13 13,0 cm, 5"
- 09121-14 14,5 cm, 5 3/4"
- 09125-14 TC**
- 09121-15 15,5 cm, 6"
- 09121-16 16,5 cm, 6 1/2"
- 09121-18 18,5 cm, 7 1/4"
- 09121-20 20,0 cm, 8"

Präparierscheren  
 Dissecting Scissors  
 Tijeras de disección  
 Forbici per dissezione

Inzisionsschere – Incision Scissors – Tijera de incision – Forbici per incisione

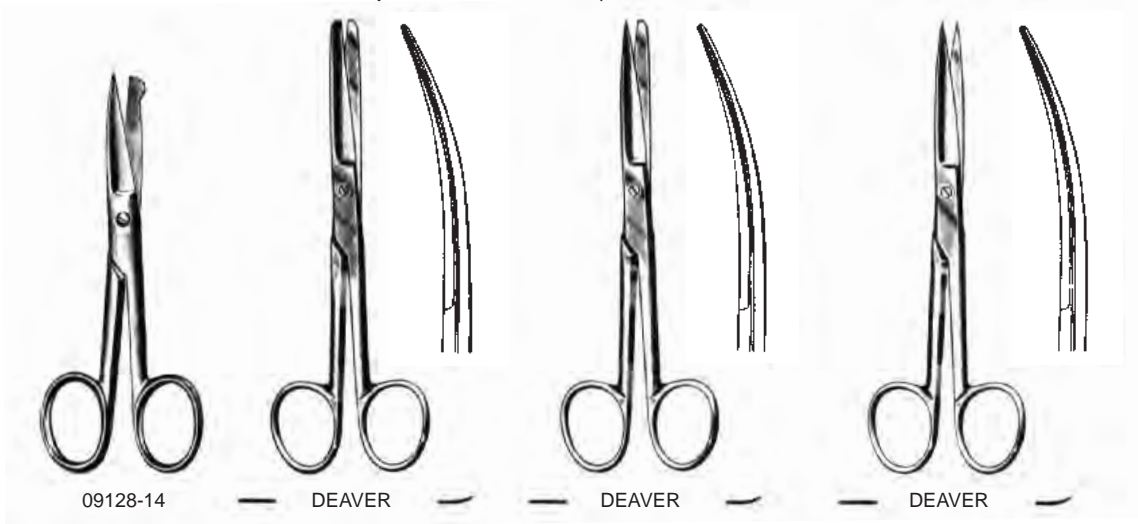

09128-14

14,0 cm  
5 1/2"

DEAVER

09130-14 14 cm 09131-14  
5 1/2"

DEAVER

09140-14 14 cm 09141-14  
5 1/2"

DEAVER

09150-14 14 cm 09151-14  
5 1/2"



MAYO

09160-14 14,5 cm 09161-14  
09164-14 TC 14,5 cm 09165-14 TC  
5 3/4"

09160-17 17,0 cm 09161-17  
09164-17 TC 17,0 cm 09165-17 TC  
6 3/4"

09160-23 23,0 cm 09161-23  
09164-23 TC 23,0 cm 09165-23 TC  
9"

MAYO-STILLE

09170-15 15,0 cm 09171-15  
09174-15 TC 15,0 cm 09175-15 TC  
6"

09170-17 17,0 cm 09171-17  
09174-17 TC 17,0 cm 09175-17 TC  
6 3/4"

09170-21 21,0 cm 09171-21  
09174-21 TC 21,0 cm 09175-21 TC  
8 1/4"

MAYO-NOBLE

09180-17 17,0 cm 09181-17  
6 3/4"



Präparierscheren  
Dissecting Scissors  
Tijeras de disección  
Forbici per dissezione



LEXER  
09190-16  
**09194-16 TC**  
16 cm, 6 1/4"



LEXER  
09191-16  
**09195-16 TC**  
16 cm, 6 1/4"



LEXER BABY  
09202-10 09203-10  
**09206-10 TC 09207-10 TC**  
10 cm, 4"



JORGENSEN  
09204-22  
22 cm, 8 3/4"

Präparierscheren  
Dissecting Scissors  
Tijeras de disección  
Forbici per dissezione



METZENBAUM	
09280-12	09284-12 TC
12 cm	4 3/4"
09280-15	09284-15 TC
15 cm	6"
09280-18	09284-18 TC
18 cm	7"
09280-20	09284-20 TC
20 cm	8"
09280-23	09284-23 TC
23 cm	9"
09280-25	09284-25 TC
25 cm	10"
09280-28	09284-28 TC
28 cm	11"
09280-30	09284-30 TC
30 cm	12"



METZENBAUM	
09281-12	09285-12 TC
12 cm	4 3/4"
09281-15	09285-15 TC
15 cm	6"
09281-18	09285-18 TC
18 cm	7"
09281-20	09285-20 TC
20 cm	8"
09281-23	09285-23 TC
23 cm	9"
09281-25	09285-25 TC
25 cm	10"
09281-28	09285-28 TC
28 cm	11"
09281-30	09285-30 TC
30 cm	12"



METZENBAUM FINO	
09282-15	09286-15 TC
15 cm	6"
09282-18	09286-18 TC
18 cm	7"
09282-20	09286-20 TC
20 cm	8"
09282-23	09286-23 TC
23 cm	9"
09282-25	09286-25 TC
25 cm	10"
09282-28	09286-28 TC
28 cm	11"



METZENBAUM FINO	
09283-15	09287-15 TC
15 cm	6"
09283-18	09287-18 TC
18 cm	7"
09283-20	09287-20 TC
20 cm	8"
09283-23	09287-23 TC
23 cm	9"
09283-25	09287-25 TC
25 cm	10"
09283-28	09287-28 TC
28 cm	11"

Präparierschere / Kapselschere  
Dissecting Scissors / Capsula Scissor  
Tijeras de disección / Tijera p. cápsula  
Forbici per dissezione / Forbici per capsula

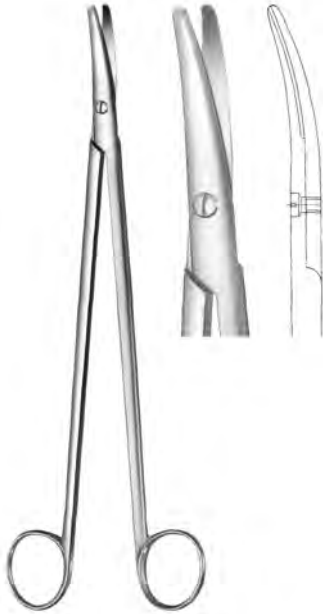

WELLER  
09289-28  
28 cm, 11"



RESANO  
09290-25  
25 cm, 10"



Chirurgische Scheren, fein  
 Operating Scissors, fine  
 Tijeras para cirugía, finas  
 Forbici per chirurgia, fine



**METZENBAUM "S"**

09291-18 18 cm, 7" **09295-18 TC**  
 09291-20 20 cm, 8" **09295-20 TC**  
 09291-23 23 cm, 9" **09295-23 TC**



**SANVENERO**

09302-14 14 cm 09303-14  
 5 1/2"



**JOSEPH**

09304-14 14 cm 09305-14  
 5 1/2"

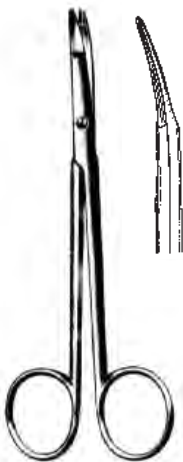

**KILNER**

09310-12 12 cm **09314-12 TC**  
 09310-15 15 cm  
 09312-12 12 cm gerade/straight/recta/retta

9 cm 3 1/2"  
 10 cm 4"  
 11 cm 4 3/8"  
 12 cm 4 3/4"  
 15 cm 6"



**REYNOLDS**

09320-15 15 cm 09321-15  
 09321-18  
**09325-15 TC**

**Iris - Standard**

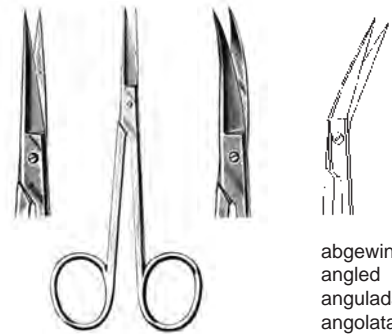

abgewinkelt  
 angled  
 angulada  
 angolata

09340-09 9 cm 09341-09 09346-11 11 cm  
 09340-10 10 cm 09341-10  
 09340-11 11 cm 09341-11  
**09344-11 TC** **09345-11 TC**

Chirurgische Scheren, fein  
 Operating Scissors, fine  
 Tijeras para cirugía, finas  
 Forbici per chirurgia, fine

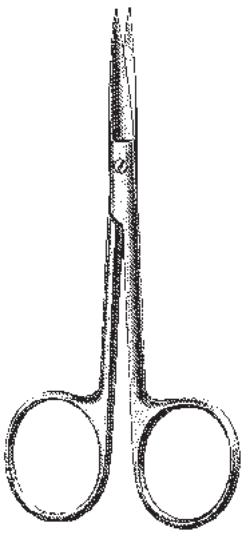

— KNAPP —  
 10 cm, 4"  
 09348-01 09348-02

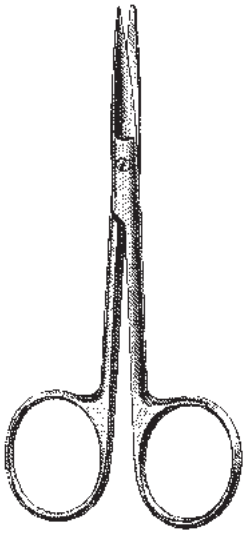

— KNAPP —  
 10 cm, 4"  
 09348-03 09348-04

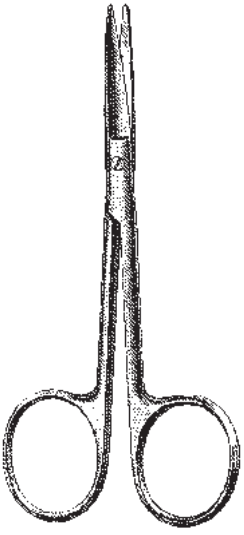

— KNAPP —  
 10 cm, 4"  
 09348-05 09348-06

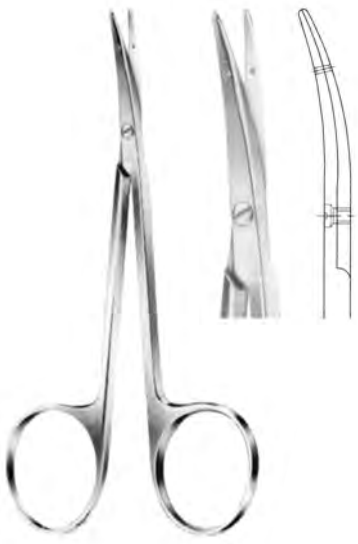

LITTLER  
 12 cm, 4 3/4"  
 09349-12

Präparierscheren, feines Modell  
Dissecting Scissors, fine pattern  
Tijeras de disección, finas  
Forbici per preparazione, modello fino



GRAEFE  
09350-10  
100 mm  
4"



COTTLE  
09358-11  
115 mm  
4 1/2"

Scheren, Ophthalmologie  
 Scissors, Ophthalmology  
 Tijeras, oftalmología  
 Forbici, per oftalmologia



GRADLE

09350-09	09351-09
9,5 cm, 3 3/4"	
gerade	gebogen
straight	curved
rectas	curvas
retta	curva



09352-09	09353-09
9,5 cm, 3 3/4"	
gerade	gebogen
straight	curved
rectas	curvas
retta	curva



09354-10	09355-10
10 cm, 4"	
gerade	gebogen
straight	curved
rectas	curvas
retta	curva



09356-10	09357-10
10 cm, 4"	
gerade	gebogen
straight	curved
rectas	curvas
retta	curva

Scheren, Ophthal, Nase  
 Scissors, Ophthal, Nasal  
 Tijeras, oftalmología, nasales  
 Forbici, oftalmologia, nasali

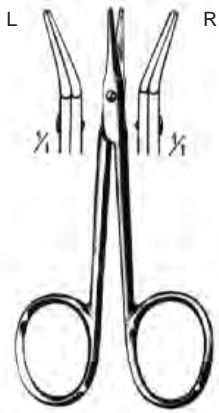

AEBLI  
 09347-09 9 cm 09349-09  
 3 1/2"



STEVENS  
 11 cm  
 4 3/8"

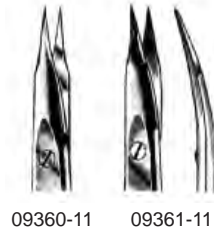

09360-11



09361-11



09362-11



09363-11



ENUCLEATION  
 09381-11  
 13 cm, 5 1/8"



STRABISMUS  
 09370-11 09371-11  
 09374-11 TC 09375-11 TC  
 11 cm, 4 3/8"



HEYMANN  
 09401-18  
 18 cm, 7"



FOMON  
 09403-15  
 15 cm, 6"

Tonsillen-, Gefäßscheren  
 Tonsil, Vascular Scissors  
 Tijeras, amígdalas y vasculares  
 Forbici per tonsilli e vascolari



COTTLE  
 09405-16  
**09406-16 TC**  
 16 cm, 6 1/4"



DEAN  
 09425-17 09427-17  
 17 cm, 6 3/4"

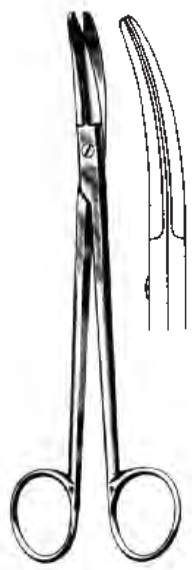

BOETTCHER  
 09435-18  
 18 cm, 7"



GOOD  
 09437-19  
 19 cm, 7 1/2"

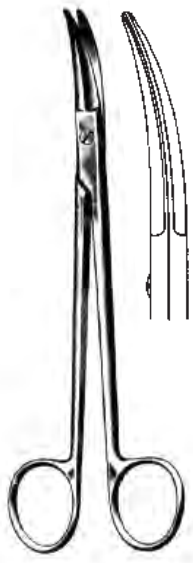

PRINCE  
 09439-17  
 17 cm, 6 3/4"



09468-15  
 15 cm, 6"



09470-11  
 11 cm, 4 3/8"

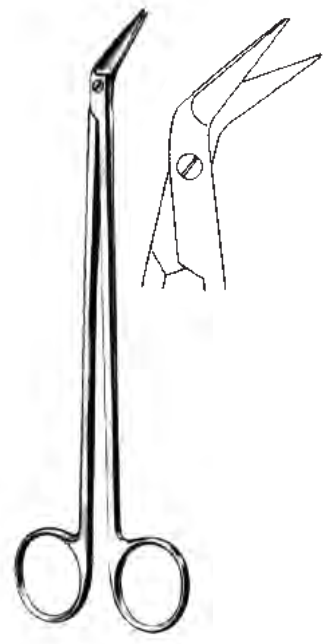

POTTS-DE MARTEL  
 09473-21  
 21 cm, 8 1/4"

Scheren, Thorax und GefäÙe  
 Scissors, thorax and vascular  
 Tijeras, torácicas y vasculares  
 Forbici vascolari e toraciche



09475-25  
**09476-25 TC**  
 18 cm, 7"



09475-45  
**09476-45 TC**  
 18 cm, 7"



09475-60  
**09476-60 TC**  
 17,5 cm, 6.9"

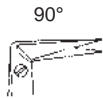

09475-90  
**09476-90 TC**  
 17 cm, 6 3/4"



09475-00  
**09476-00 TC**  
 17 cm, 6 3/4"

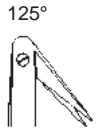

DIETRICH  
 09477-01  
 17 cm, 6 3/4"

DIETRICH  
 09475-25 – 09475-00  
 17 cm, 6 3/4"

Scheren mit Hartmetalleinsätzen  
 Scissors with Tungsten Carbide  
 Tijeras con carburo de tungsteno  
 Forbici con carburo di tungsteno



De Bakey  
 (Potts-Smith)



**09478-25**  
 19 cm  
 7 1/2"

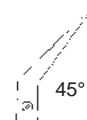

**09478-45**  
 19 cm  
 7 1/2"



**09478-60**  
 19 cm  
 7 1/2"



**09479-25**  
 23 cm  
 9"



**09479-45**  
 23 cm  
 9"

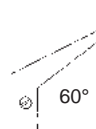

**09479-60**  
 23 cm  
 9"

Gefäßscheren  
 Vascular Scissors  
 Tijeras vasculares  
 Forbici vascolari



POTTS-SMITH  
 19 cm, 7 1/2"

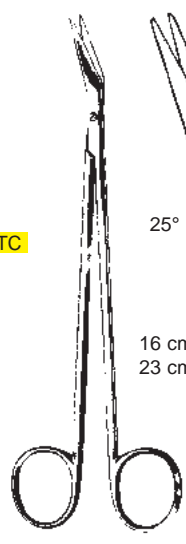
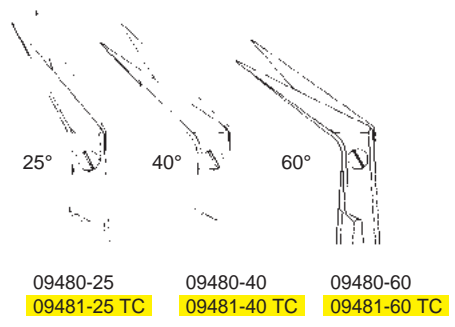

DE BAKEY

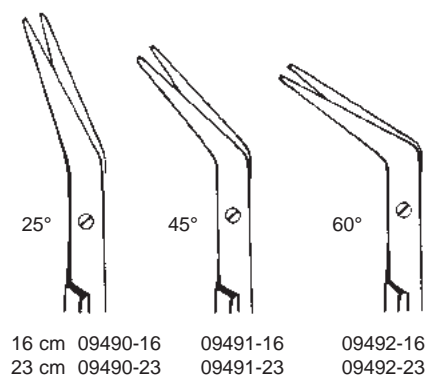

FAVALORO  
 09496-15 15 cm, 6"

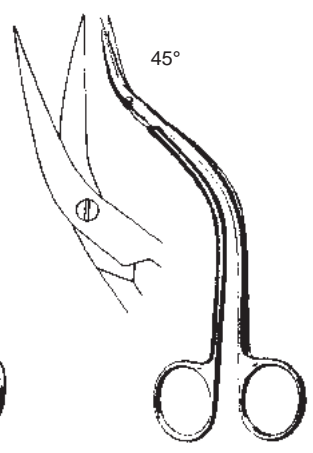

DE BAKEY  
 09497-15 15,5 cm, 6"



KELLY  
 09540-16 09541-16  
 09542-16 TC 09543-16 TC  
 16 cm, 6 1/4"



Gynäkologische Scheren  
 Gynecological Scissors  
 Tijeras ginecológicas  
 Forbici ginecologiche



SIMS

09510-20 20 cm, 8" 09511-20  
 09510-23 23 cm, 9" 09511-23

09516-23 TC 23 cm, 9" 09517-23 TC



09512-20  
 09512-23



09513-20  
 09513-23



09514-20  
 09514-23



09515-20  
 09515-23

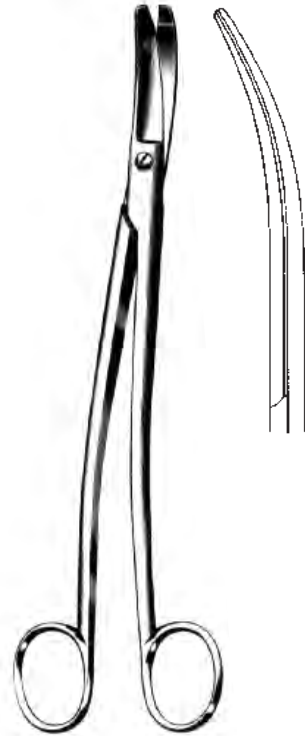

SIEBOLD

09523-24 24 cm, 9 1/2"

Gynäkologische Scheren  
 Gynecological Scissors  
 Tijeras ginecológicas  
 Forbici ginecologiche

**Parametrium**

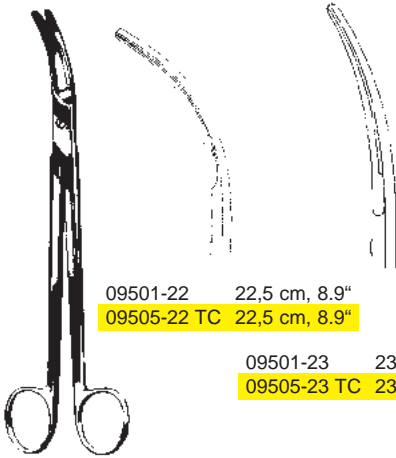

09501-22 22,5 cm, 8.9"  
 09505-22 TC 22,5 cm, 8.9"

09501-23 23 cm, 9"  
 09505-23 TC 23 cm, 9"



WERTHEIM  
 09525-22 22,5 cm, 8.9"



DOYEN  
 09530-17 09531-17  
 17,5 cm, 6.9"



DUBOIS  
 09536-27 09537-27  
 27 cm, 10 1/2"

Chirurgische Scheren  
 Operating Scissors  
 Tijeras para cirugía  
 Forbici per chirurgia



gezahnt  
 saw edge  
 dentadas  
 dentellata

WALDMANN  
 09548-18  
 18 cm, 7"



U.S.A. Mod.  
 09550-10  
 10,5 cm, 4"



BUSCH  
 09551-16  
 16 cm, 6 1/4"



SCHUMACHER  
 09553-16  
 16 cm, 6 1/4"



BRAUN-STADLER  
 09560-14 14,5 cm, 5 3/4"  
 09560-22 22,0 cm, 8 3/4"

Chirurgische Scheren  
 Operating Scissors  
 Tijeras para cirugía  
 Forbici per chirurgia

**Neurochirurgie - Neurosurgery - Neurocirugía - Neurochirurgia**



09580-11 09581-11  
 11 cm, 4 3/8"



09582-15 09583-15  
 15 cm, 6"

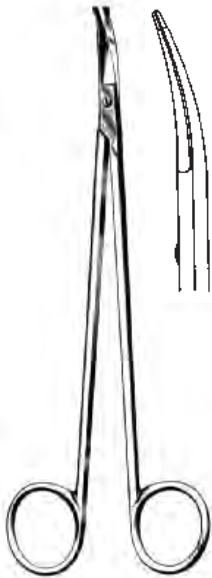

STRULLY  
 09601-22  
 22 cm, 8 3/4"



TOENNIS-ADSON  
 09610-18  
 18 cm, 7"



TOENNIS-ADSON  
 09611-18  
 18 cm, 7"

Chirurgische Scheren  
Operating Scissors  
Tijeras para cirugía  
Forbici per chirurgia



gezahnt  
saw edge  
dentadas  
dentellata

MARTIN CARTILAGE  
09613-20  
20 cm, 8"



McINDOE  
09614-19  
19 cm, 7 1/2"



FOMON  
09617-13  
13 cm, 5 1/8"

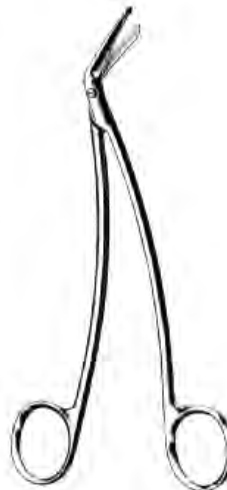

SCHMIEDEN-TAYLOR  
09619-17  
17 cm, 6 3/4"

Chirurgische Scheren  
 Operating Scissors  
 Tijeras para cirugía  
 Forbici per chirurgia

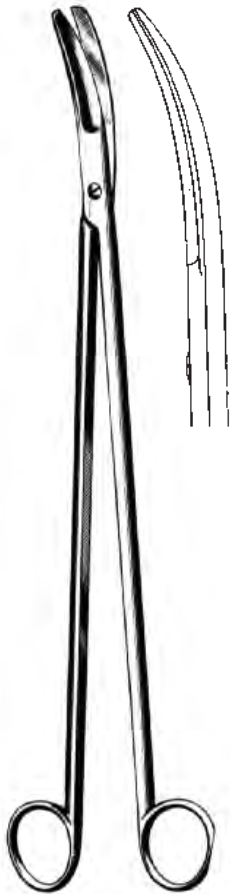

**CRAFOORD**  
 09641-30  
 30 cm, 11 3/4"



**THOREK**  
 09643-19 19 cm, 7 1/2"  
 09643-25 25 cm, 10"



**SATINSKY**  
 09651-24  
 24,5 cm, 9 1/2"

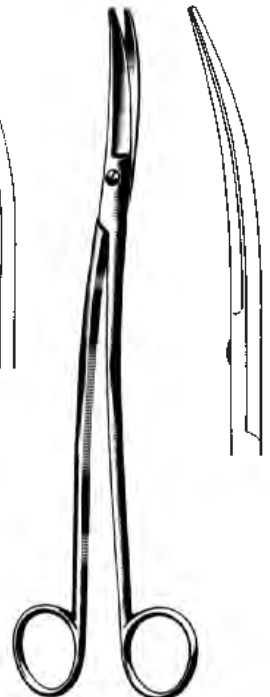

**KLINKENBERGH-LOTH**  
 09661-23  
 23 cm, 9"

Chirurgische Scheren  
 Operating Scissors  
 Tijeras para cirugía  
 Forbici per chirurgia

**Darmscheren**  
**Enterotomy Scissors**  
**Enterótomos**  
**Forbici per enterotomia**



**FERGUSSON**  
 09770-18  
 18 cm, 7"



09772-21  
 21 cm, 8 1/4"



09774-21  
 21 cm, 8 1/4"



— SYSTRUNK —  
 09775-13 09777-13  
 13 cm, 5 1/8"

**Ligaturscheren, Fadenscheren**  
**Ligature Scissors**  
**Tijeras para ligaduras**  
**Forbici per legature**



**SPENCER**  
 09802-09  
 9 cm, 3 1/2"



**SPENCER**  
 09802-11  
 11 cm, 4 3/8"



**NORTHBENT**  
 09803-09 9 cm, 3 1/2"  
 09803-13 13 cm, 5 1/8"



**LITTAUER**  
 09804-14  
 14 cm, 5 1/2"



**HEATH**  
 09809-15  
 15 cm, 6"

Chirurgische Scheren  
 Operating Scissors  
 Tijeras para cirugía  
 Forbici per chirurgia

**Zahnfleischscheren**  
**Gum Scissors**  
**Tijeras para encías**  
**Forbici gengivali**

1 Schneide gezahnt  
 1 blade toothed  
 1 hoja dentada  
 1 taglio della lama dentellato

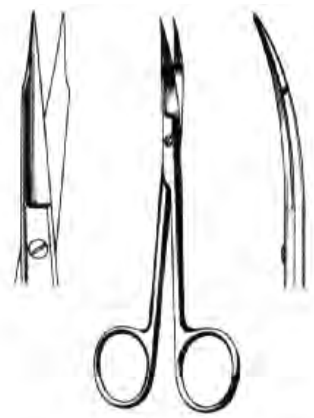

**GOLDMAN-FOX**  
 09820-13 13 cm, 5 1/8" 09821-13



**WAGNER**  
 12 cm, 4 3/4"

gerade  
 straight  
 rectas  
 rette



Fig. 1  
 09828-12



Fig. 2  
 09826-12



Fig. 3  
 09824-12

gebogen  
 curved  
 curvas  
 curve



Fig. 1  
 09823-12



Fig. 2  
 09829-12

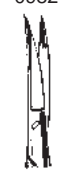

Fig. 3  
 09825-12

**Draht-, Blechscherer**  
**Wire and plate shears**  
**Tijeras para alambre y láminas**  
**Forbici per filo di metallo e lamiera**



**QUINBY**  
 09827-12 12 cm, 4 3/4"



**UNIVERSAL**  
 09831-12 12 cm, 4 3/4"  
 09835-12 TC 12 cm, 4 3/4"



Beebee Kronenscheren  
Beebee Crown Scissors  
Beebee Tijeras para coronas  
Beebee Forbici per corona



Beebee

09850-10  
gerade 10,5 cm (4") spitz  
straight 10,5 cm (4") pointed  
rectas 10,5 cm (4") agudas  
rette 10,5 cm (4") acute

09852-10  
gerade 10,5 cm (4") stumpf  
straight 10,5 cm (4") blunt  
rectas 10,5 cm (4") romas  
rette 10,5 cm (4") smusse

09851-10  
gebogen 10,5 cm (4") spitz  
curved 10,5 cm (4") pointed  
curvas 10,5 cm (4") agudas  
curve 10,5 cm (4") acute

09853-10  
gebogen 10,5 cm (4") stumpf  
curved 10,5 cm (4") blunt  
curvas 10,5 cm (4") romas  
curve 10,5 cm (4") smusse

Zahnfleissscheren  
 Gum Scissors  
 Tijeras para encias  
 Forbici gengivali



LA Grange  
 09854-11  
 11,5 cm, 4 1/2"



gezahnt  
 saw edge  
 dentadas  
 dentellata

LOCKLIN  
 09859-16  
 16 cm, 6 1/4"



gezahnt  
 saw edge  
 dentadas  
 dentellata

LOCKLIN  
 09860-16  
 16,5 cm, 6 1/2"



LOCKLIN  
**09861-16 TC**  
 16,5 cm, 6 1/2"

Verbandscheren  
 Bandage Scissors  
 Tijeras para vendajes  
 Forbici per bendaggi

Gaze  
 Gauze  
 Gaza  
 Garza



SMITH US ARMY  
 09898-20  
 20 cm, 8"



LISTER  
 9 cm, 3 1/2" 09901-09  
 11 cm, 4 3/8" 09901-11  
 14 cm, 5 1/2" 09901-14 **09905-14 TC**  
 18 cm, 7" 09901-18 **09905-18 TC**  
 20 cm, 8" 09901-20



LISTER  
 09906-18 18 cm, 7"  
 09906-20 20 cm, 8"



BERGMANN  
 09911-23  
 23 cm, 9"

Verbandscheren  
 Bandage Scissors  
 Tijeras para vendajes  
 Forbici per bendaggi



ESMARCH  
 09913-20 20 cm, 8"  
 09913-22 22 cm, 8 3/4"



SEUTIN  
 09915-23  
 23 cm, 9"



gezahnt  
 toothed  
 dentadas  
 dentellata

REDA EXCENTER  
 09921-16 16 cm, 6 1/4"  
 09921-19 19 cm, 7 1/2"

Verbandscheren  
 Bandage Scissors  
 Tijeras para vendajes  
 Forbici per bendaggi



KNOWLES  
 09930-14  
 14 cm, 5 1/2"



KNOWLES  
 09931-14  
 14 cm, 5 1/2"



LORENZ  
 09933-23  
 23 cm, 9"



BRUNS  
 09935-23 23 cm, 9" **09939-23 TC**  
 09937-23 23 cm, 9"



09941-20  
 20 cm, 8"

in verschiedenen Farben lieferbar  
 in different colours available  
 en diferentes colores disponibles  
 in differenti colori disponibile



UNIVERSAL  
 09950-15 15 cm, 6"  
 09950-18 18 cm, 7"

Supercut Scheren  
 Supercut Scissors  
 Tijeras Supercut  
 Forbici Supercut



gezahnt  
 saw edge  
 dentadas  
 dentellate

09960-14 09961-14  
 14,5 cm, 5 3/4"

gerade gebogen  
 straight curved  
 rectas curvas  
 rette curve



gezahnt  
 saw edge  
 dentadas  
 dentellate

MAYO

09962-14 14,5 cm 09963-14  
 09962-17 17,0 cm 09963-17  
 09962-23 23,0 cm 09963-23

gerade gebogen  
 straight curved  
 rectas curvas  
 rette curve



gezahnt  
 saw edge  
 dentadas  
 dentellate

MAYO-STILLE

09964-15 15,0 cm 09965-15  
 09964-17 17,0 cm 09965-17

gerade gebogen  
 straight curved  
 rectas curvas  
 rette curve



gezahnt  
 saw edge  
 dentadas  
 dentellate

BABY METZENBAUM

09966-11 09967-11  
 11,5 cm, 4 1/2"

gerade gebogen  
 straight curved  
 rectas curvas  
 rette curve



gezahnt  
 saw edge  
 dentadas  
 dentellate

METZENBAUM

09970-14 14,5 cm 09971-14  
 09970-18 18,0 cm 09971-18  
 09970-20 20,0 cm 09971-20  
 09970-23 23,0 cm 09971-23

gerade gebogen  
 straight curved  
 rectas curvas  
 rette curve

Supercut Scheren  
 Supercut Scissors  
 Tijeras Supercut  
 Forbici Supercut



gezahnt  
 saw edge  
 dentadas  
 dentellate

**IRIS**  
 09980-11 09981-11  
 11,5 cm, 4 1/2"  
 gerade gebogen  
 straight curved  
 rectas curvas  
 rette curve



gezahnt  
 saw edge  
 dentadas  
 dentellate

**WAGNER**  
 09982-12 09983-12  
 12 cm, 4 3/4"  
 gerade gebogen  
 straight curved  
 rectas curvas  
 rette curve



**STEVENS**  
 09984-11 09985-11  
 11,5 cm, 4 1/2"  
 gerade gebogen  
 straight curved  
 rectas curvas  
 rette curve



gezahnt  
 saw edge  
 dentadas  
 dentellate

**LaGrange**  
 09986-11 11,5 cm, 4 1/2"



gezahnt  
 saw edge  
 dentadas  
 dentellate

**LISTER**  
 09990-14 14,5 cm, 5 3/4"  
 09990-18 18,0 cm, 7"



**REYNOLDS**  
 09993-15 15 cm, 6"  
 09993-18 18 cm, 7"



**KILNER/RAGNELL**  
 09995-12 12 cm, 4 3/4"

Face Lift Scheren  
 Face Lift Scissors  
 Tijeras Face Lift  
 Forbici Face Lift



**GORNEY FACE LIFT**  
 19 cm, 7 1/2"

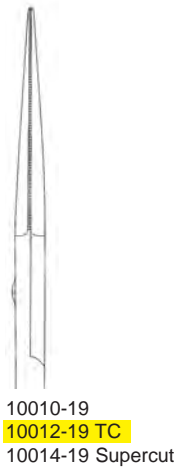

10010-19  
**10012-19 TC**  
 10014-19 Supercut

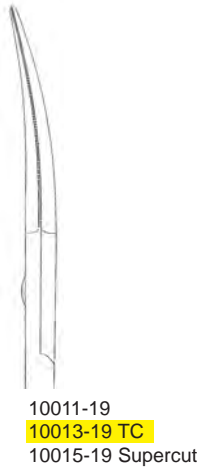

10011-19  
**10013-19 TC**  
 10015-19 Supercut



**REES FACE LIFT**

- 10016-17 — 17,0 cm, 6 3/4"
- 10017-17 — 17,0 cm, 6 3/4"
- 10018-20 — 20,5 cm, 8"
- 10019-20 — 20,5 cm, 8"

- TC**
- 10020-17** — 17,0 cm, 6 3/4"
  - 10021-17** — 17,0 cm, 6 3/4"
  - 10022-20** — 20,5 cm, 8"
  - 10023-20** — 20,5 cm, 8"

- Supercut**
- 10024-17 — 17,0 cm, 6 3/4"
  - 10025-17 — 17,0 cm, 6 3/4"
  - 10026-20 — 20,5 cm, 8"
  - 10027-20 — 20,5 cm, 8"



**KAYE FACE LIFT**



- TC**
- 10028-14** — 14,5 cm, 5 3/4"
  - 10029-14** — 14,5 cm, 5 3/4"
  - 10030-18** — 18,5 cm, 7 1/4"
  - 10031-18** — 18,5 cm, 7 1/4"
  - 10032-23** — 23,0 cm, 9"
  - 10033-23** — 23,0 cm, 9"

- Supercut**
- 10034-14 — 14,5 cm, 5 3/4"
  - 10035-14 — 14,5 cm, 5 3/4"
  - 10036-18 — 18,5 cm, 7 1/4"
  - 10037-18 — 18,5 cm, 7 1/4"
  - 10038-23 — 23,0 cm, 9"
  - 10039-23 — 23,0 cm, 9"









Face Lift Scheren  
 Face Lift Scissors  
 Tijeras Face Lift  
 Forbici Face Lift



- |                    |   |           |
|--------------------|---|-----------|
| 10040-18           |  | 18 cm, 7" |
| <b>10041-18 TC</b> |  | 18 cm, 7" |
| 10042-18 Supercut  |  | 18 cm, 7" |

FREEMAN FACE LIFT



- |                    |   |                 |
|--------------------|---|-----------------|
| 10044-14           |  | 14,5 cm, 5 3/4" |
| 10045-14           |  | 14,5 cm, 5 3/4" |
| <b>10046-14 TC</b> |  | 14,5 cm, 5 3/4" |
| <b>10047-14 TC</b> |  | 14,5 cm, 5 3/4" |
| 10048-14 Supercut  |  | 14,5 cm, 5 3/4" |
| 10049-14 Supercut  |  | 14,5 cm, 5 3/4" |

PECK JOSEPH

Augenscheren  
 Ophthalmic Scissors  
 Tijeras oculares  
 Forbici oculistiche



WESTCOTT  
 10102-11  
 11 cm, 4 3/8"



WESTCOTT  
 10104-11  
 11 cm, 4 3/8"



NOYES  
 10110-12 10111-12  
 12 cm, 4 3/4"



WECKER  
 11 cm, 4 3/8"



10113-11



10115-11



10117-11



BARRAQUER  
 10119-10 5,5 cm, 2.2"  
 (Colibri)

Mikro-Scheren  
 Micro-Scissors  
 Micro-Tijeras  
 Micro-Forbici



10120-16  
 10120-18  
 10120-22

16,0 cm, 6 1/4"  
 18,5 cm, 7 1/4"  
 22,5 cm, 8.9"



10121-16  
 10121-18  
 10121-22



10122-16  
 10122-18  
 10122-22

16,0 cm, 6 1/4"  
 18,5 cm, 7 1/4"  
 22,5 cm, 8.9"



10123-16  
 10123-18  
 10123-22



10124-16  
 10124-18  
 10124-22

16,0 cm, 6 1/4"  
 18,5 cm, 7 1/4"  
 22,5 cm, 8.9"



10125-16  
 10125-18  
 10125-22

Circumflex

Mikro-Scheren  
 Micro-Scissors  
 Micro-Tijeras  
 Micro-Forbici

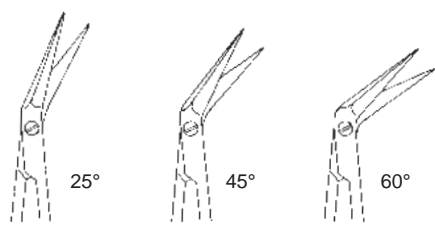

25°

45°

60°

10126-25

10126-45

10126-60

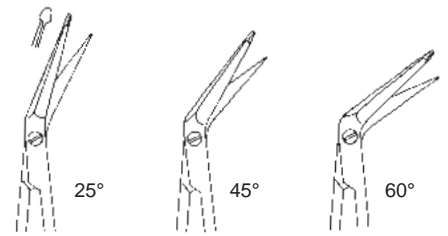

25°

45°

60°

10127-25

10127-45

10127-60

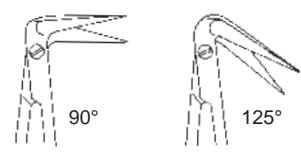

90°

125°

10126-90

10126-00

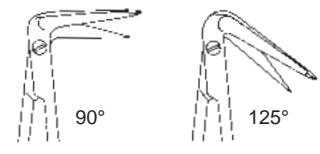

90°

125°

10127-90

10127-00



Reda  
 18 cm, 7"

Mikro-Scheren  
 Micro-Scissors  
 Micro-Tijeras  
 Micro-Forbici



10128-09  
 9 cm, 3 1/2"



10128-15 15 cm, 6"  
 gerade  
 straight  
 rectas  
 rette

10129-15 15 cm, 6"  
 gebogen  
 curved  
 curvas  
 curvo

10130-15 15 cm, 6"  
 gebogen, 1 Schneide gezahnt  
 curved, 1 blade toothed  
 curvas, 1 hoja dentada  
 curva, 1 lama dentellata

10128-15 - 10130-15  
 15 cm, 6"

halbscharf  
 semi-sharp  
 medio roma  
 lame semi smusse



Hepp-Scheidel  
 10131-14 14 cm, 5 1/2"  
 10131-16 16 cm, 6 1/4"



Hepp-Scheidel  
 10132-18  
 18 cm, 7"



Hepp-Scheidel 10137-01  
 18 cm, 7"  
 spitz  
 pointed  
 agudas  
 acute

Hepp-Scheidel 10137-02  
 18 cm, 7"  
 stumpf  
 blunt  
 romas  
 smusse

Augen-, Mikroscheren  
 Ophthalmic, Micro Scissors  
 Tijeras oculares, micro tijeras  
 Forbici oculistiche, micro chirurg.

**Iridektomie, Iridectomy, Iridectomía, iridectomia**

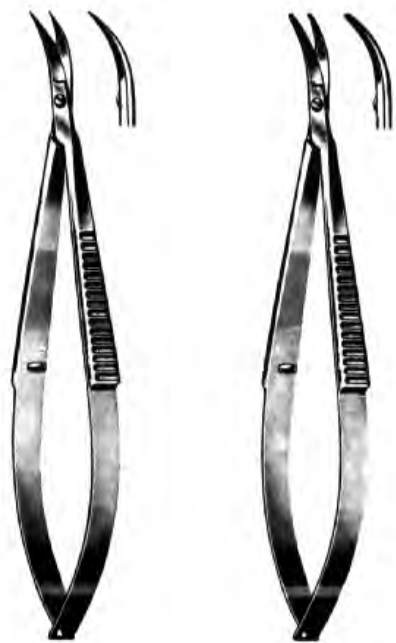

**CASTROVIEJO**  
 10133-10 10 cm, 4"

**CASTROVIEJO**  
 10135-10 10 cm, 4"



**VANNAS**  
 10140-08 8 cm, 3 1/8"



**VANNAS**  
 10141-08 8 cm, 3 1/8"



10142-08  
 kniegebogen  
 angular  
 acodada  
 angolate



10143-08  
 aufgewinkelt  
 angled up  
 acodada hacia arriba  
 angolate verso l'alto

**Hornhautscheren, Corneal scissors, Tijeras corneales, Forbici corneali**



**CASTROVIEJO**  
 10151-11 11 cm, 4 3/8"



**CASTROVIEJO**  
 10153-11 11 cm, 4 3/8"



**CASTROVIEJO**  
 10155-11 11 cm, 4 3/8"

Mikro-Scheren  
 Micro-Scissors  
 Micro-Tijeras  
 Micro-Forbici



Reda  
 10202-18 - 10203-18  
 18 cm, 7"



GOMEL



10313-14  
 14 cm  
 5 1/2"



10313-16  
 16 cm  
 6 1/4"



Reda micro  
 10320-09  
 9 cm, 3 1/2"



Reda  
 10330-19 - 10333-19  
 18,5 cm, 7 1/4"



10330-19



10331-19



10333-19

Anatomische und chirurgische Pinzetten  
 Dressing and Tissue Forceps  
 Pinzas de disección, sin/con dientes  
 Pinze per dissezione, chirurgiche/anatomiche

STANDARD



USA

STILLE

cm		11102-10			
10,5	4 1/4"	11102-11			
11,5	4 1/2"			11104-12	
12,0	4 3/4"	11102-13		11104-13	11106-13
13,0	5 1/8"	11102-14	11103-14	11104-14	
14,5	5 3/4"				11106-15
15,0	6"			11104-15	
15,5	6"	11102-16			
16,0	6 1/4"	11102-18		11104-18	
18,0	7"	11102-20			
20,0	8"			11104-21	
21,0	8 1/4"	11102-25		11104-25	
25,0	10"	11102-30			
30,0	12"				



POTTS-SMITH



POTTS-SMITH  
1x2

cm					
10,5	4 1/4"				
11,5	4 1/2"	11110-11			
12,0	4 3/4"				
13,0	5 1/8"	11110-13			
14,5	5 3/4"	11110-14	11114-14 TC		
15,0	6"				
15,5	6"				
16,0	6 1/4"	11110-16	11114-16 TC		
18,0	7"	11110-18		11112-18	11116-18 TC
20,0	8"	11110-20	11114-20 TC		11126-18
21,0	8 1/4"			11112-21	11116-21 TC
25,0	10"	11110-25	11114-25 TC	11112-25	11116-25 TC
30,0	12"	11110-30			11126-25



Chirurgische Pinzetten  
Tissue Forceps  
Pinzas de disección, con dientes  
Pinze per dissezione, chirurgiche

STANDARD



1x2



USA



STILLE



schmal  
narrow  
estrecha  
stretta

1x2

cm

10,5	4 1/4"	11120-10			
11,5	4 1/2"	11120-11			11130-11
12,0	4 3/4"		11122-12		
13,0	5 1/8"	11120-13	11122-13		11130-13
14,5	5 3/4"	11120-14	11122-14		11130-14
15,0	6"			11124-15	
15,5	6"		11122-15		
16,0	6 1/4"	11120-16			11130-16
18,0	7"	11120-18	11122-18		11130-18
20,0	8"	11120-20			11130-20
21,0	8 1/4"		11122-21		
25,0	10"	11120-25	11122-25		
30,0	12"	11120-30			



OEHLER



2x3



3x4



4x5

cm

10,5	4 1/4"				
11,5	4 1/2"		11140-11		
12,0	4 3/4"				
13,0	5 1/8"		11140-13	11150-13	11160-13
14,5	5 3/4"		11140-14	11150-14	11160-14
15,0	6"				
15,5	6"				
16,0	6 1/4"	11132-16 TC	11140-16	11150-16	11160-16
18,0	7"	11132-18 TC	11140-18		
20,0	8"	11132-20 TC	11140-20		
21,0	8 1/4"				
25,0	10"	11132-25 TC	11140-25		
30,0	12"	11132-30 TC			

Anatomische und chirurgische Pinzetten  
 Dressing and Tissue Forceps  
 Pinzas de disección, sin/con dientes  
 Pinze per dissezione, chirurgiche/anatomiche



ADSON  
 11170-12 12,0 cm, 4 3/4"  
 11170-15 15,0 cm, 6"



ADSON  
 11174-12 TC 12,0 cm, 4 3/4"  
 11174-15 TC 15,0 cm, 6"



ADSON micro  
 11176-12 12,0 cm, 4 3/4"  
 11176-15 15,0 cm, 6"



Adson-DeBakey atraumatic  
 11177-12  
 12,0 cm, 4 3/4"



ADSON  
 11178-12  
 12,0 cm, 4 3/4"



ADSON  
 11179-12  
 12 cm, 4 3/4"

1x2

2x3

Anatomische und chirurgische Pinzetten  
 Dressing and Tissue Forceps  
 Pinzas de disección, sin/con dientes  
 Pinze per dissezione, anatomiche/chirurgiche



1x2

ADSON

11180-12 12,0 cm, 4 3/4"  
 11180-15 15,0 cm, 6"



1x2

ADSON

11181-12 TC 12,0 cm, 4 3/4"  
 11181-15 TC 15,0 cm, 6"



1x2

ADSON micro

11186-12 12,0 cm, 4 3/4"  
 11186-15 15,0 cm, 6"



1x2

ADSON

11187-12  
 12 cm, 4 3/4"



7x7

ADSON-BROWN

11188-12 12,0 cm, 4 3/4"  
 11188-15 15,0 cm, 6"  
 11189-12 TC 12,0 cm, 4 3/4"

Anatomische und chirurgische Pinzetten  
 Dressing and Tissue Forceps  
 Pinzas de disección, sin/con dientes  
 Pinze per dissezione, chirurgiche/anatomiche



9x9

**BROWN**  
 11189-15 15,0 cm, 6"  
 11189-20 20,0 cm, 8"  
 11189-25 25,0 cm, 10"



**GRAEFE**  
 11190-10 10,5 cm, 4.1"



1x2

**WAUGH**  
 11187-18 18 cm, 7"  
 11187-20 20 cm, 8"  
 11187-25 25 cm, 10"  
 11187-30 30 cm, 11 3/4"



17 cm  
 6 3/4"

**CUSHING**  
 11220-17  
**11224-17 TC**  
 17,0 cm, 6 3/4"



17 cm  
 6 3/4"

**CUSHING**  
 11222-17  
**11225-17 TC**

1x2



5x6

**LERCHE**  
 11232-15  
 15,0 cm, 6"

Anatomische und chirurgische Pinzetten, Faßpinzetten  
 Dressing and Tissue Forceps  
 Pinzas de disección, sin/con dientes  
 Pinze per dissezione, chirurgiche/anatomiche



**BROPHY**  
 11231-20  
 20,0 cm, 8"



**BROPHY**  
 11233-20  
 20,0 cm, 8"



**BROPHY**

11234-20

11235-20



4x5

**ADLERKREUTZ**  
 11236-15 15,0 cm, 6"  
 11236-20 20,0 cm, 8"



**DUEHRSEN**  
 11237-20  
 20 cm, 8"



1x2

**LANE**  
 11240-14  
 14,5 cm, 5 3/4"



2x3

**LANE**  
 11242-14  
 14,5 cm, 5 3/4"



Anatomische und chirurgische Pinzetten, Faßpinzetten  
Dressing and Tissue Forceps  
Pinzas de disección, sin/con dientes  
Pinze per dissezione, chirurgiche/anatomiche



FERRIS-SMITH  
11246-18  
18,0 cm, 7"



FERRIS-SMITH  
11248-18  
18,0 cm, 7"



DUVAL  
11250-14  
14,5 cm, 5 3/4"



COLLIN-DUVAL  
11252-20  
20,0 cm, 8"



Russ. Mod.  
11256-15 15,0 cm, 6"  
11256-20 20,0 cm, 8"  
11256-25 25,0 cm, 10"



McINDOE  
11257-15  
15,0 cm, 6"



McINDOE  
11258-15 15,0 cm, 6"  
11259-15 TC 15,0 cm, 6"

Anatomische und chirurgische Pinzetten  
 Dressing and Tissue Forceps  
 Pinzas de disección, sin/con dientes  
 Pinze per dissezione, chirurgiche/anatomiche



SEMKEN  
 11260-12 12,5 cm, 5"  
 11260-15 15,5 cm, 6"  
 11261-15 TC 15,5 cm, 6"



SEMKEN  
 11270-12 12,5 cm, 5"  
 11270-15 15,5 cm, 6"  
 11271-15 TC 15,5 cm, 6"  
 11271-18 TC 18 cm, 7"



GILLIES  
 11272-15 15,5 cm, 6"  
 11273-15 TC 15,5 cm, 6"



15,5 cm, 6"



GERALD  
 11302-17 17,5 cm, 6.9"  
 11302-23 23,0 cm, 9"  
 11304-17 TC 17,0 cm, 6 3/4"



GERALD  
 11303-17  
 17,5 cm, 6.9"

Anatomische und chirurgische Pinzetten  
 Dressing and Tissue Forceps  
 Pinzas de disección, sin/con dientes  
 Pinze per dissezione, chirurgiche/anatomiche



GERALD  
 11305-17  
 17,5 cm, 6.9"



GERALD  
 11310-17 17,5 cm, 6.9"  
 11312-17 TC 17,5 cm, 6.9"



GERALD  
 11311-17  
 17,5 cm, 6.9"



CUSHING-Taylor  
 11312-18 TC  
 18,5 cm, 7 1/4"



GERALD  
 11313-17  
 17,5 cm, 6.9"



11314-01  
 17 cm, 6 3/4"



11314-02  
 17 cm (6 3/4")  
 1x2



TAYLOR

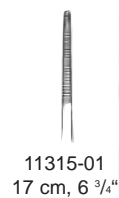

11315-01  
 17 cm, 6 3/4"



TAYLOR

11315-02  
 17 cm (6 3/4")  
 1x2



Anatomische und chirurgische Pinzetten  
 Dressing and Tissue Forceps  
 Pinzas de disección, sin/con dientes  
 Pinze per dissezione, chirurgiche/anatomiche

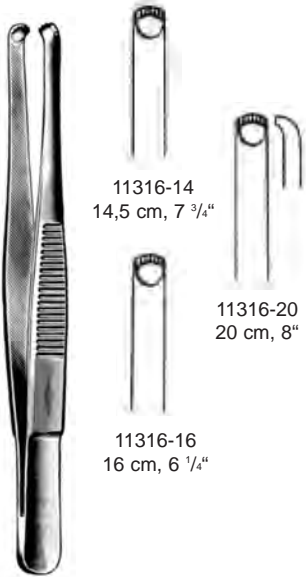

11316-14  
 14,5 cm, 7 3/4"

11316-20  
 20 cm, 8"

11316-16  
 16 cm, 6 1/4"

DURANTE



11317-12 1x2  
 11317-23 2x3  
 11319-12 TC 1x2

11317-00  
 ohne Zähne  
 without teeth  
 sin dientes  
 senza denti

BONNEY  
 18 cm, 7"

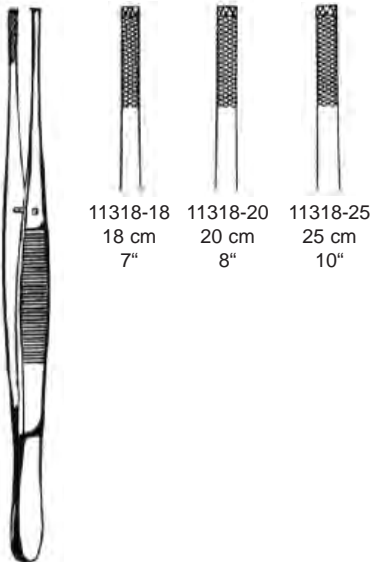

11318-18  
 18 cm  
 7"

11318-20  
 20 cm  
 8"

11318-25  
 25 cm  
 10"

STILLE-BARRAYA  
 3x4

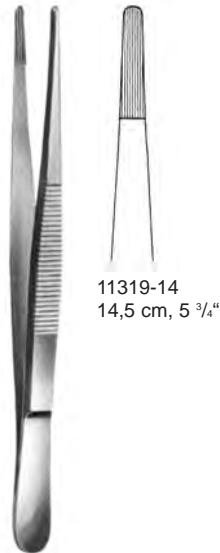

11319-14  
 14,5 cm, 5 3/4"

OCHSNER



SINGLEY  
 11320-18 18 cm 7"  
 11320-23 23 cm 9"

Anatomische und chirurgische Pinzetten  
 Dressing and Tissue Forceps  
 Pinzas de disección, sin/con dientes  
 Pinze per dissezione, chirurgiche/anatomiche



**NELSON**  
 11322-15 15 cm 6"  
 11322-18 18 cm 7"  
 11322-23 23 cm 9"



**WANGENSTEEN**  
 11324-23  
 23 cm 9"



11325-15 TC  
 15 cm, 6"

11325-23 TC  
 23 cm, 9"

11325-25 TC  
 25 cm, 10"

**WANGENSTEEN**



11326-23

**MAYO**  
 23 cm, 9"



1x2 Zähne

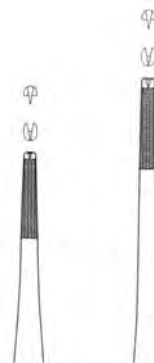

11328-15  
 15 cm, 6"

11328-20  
 20 cm, 8"

**STRASSBURGER  
 MODELL**

Splitterpinzetten  
Splinter Forceps  
Pinzas para espinas  
Pinze per schegge

Fig.: 1



11401-01  
12 cm, 4 <sup>3</sup>/<sub>4</sub>"

3



11403-03  
12 cm, 4 <sup>3</sup>/<sub>4</sub>"

3c



11403-04  
11 cm, 4 <sup>3</sup>/<sub>8</sub>"

Fig.: 4



11404-04  
11 cm, 4 <sup>3</sup>/<sub>8</sub>"

5



11405-05  
11 cm, 4 <sup>3</sup>/<sub>8</sub>"

7



11407-07  
12 cm, 4 <sup>3</sup>/<sub>4</sub>"

Splitterpinzetten  
 Splinter Forceps  
 Pinzas para espinas  
 Pinze per schegge



11802-09 9,0 cm, 3 1/2"  
 11802-10 10,5 cm, 4.1"  
 11802-11 11,5 cm, 4 1/2"



**FEILCHENFELD**  
 11810-07 7,5 cm, 3"  
 11810-09 9,0 cm, 3 1/2"  
 11810-11 11,5 cm, 4 1/2"



**HUNTER**  
 11812-10 10,5 cm, 4.1"



**HUNTER**  
 11813-10  
 10,5 cm, 4.1"



**HUNTER**  
 11815-12  
 12,5 cm, 5"



**CARMALT**  
 11816-10  
 10,5 cm, 4.1"



**CARMALT**  
 11817-10  
 10,5 cm, 4.1"

Splitterzangen  
 Splinter Forceps  
 Pinzas para espinas  
 Pinze per schegge



**PEET**  
 11821-11  
 11,5 cm, 4 1/2"



**STIEGLITZ**  
 11822-13 11823-13  
 13,5 cm, 5 1/4"



**ARCHER**  
 11824-14 11825-14  
 14 cm, 5 1/2"



**VIRTUS (RALK)**  
 11828-15 11829-15  
 15 cm, 6"

Zahnpinzetten  
Dental Forceps  
Pinzas dentales  
Pinze dentali

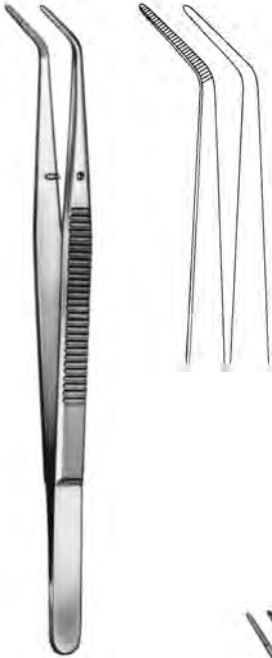

LONDON-COLLEGE  
11900-01  
15 cm 6"

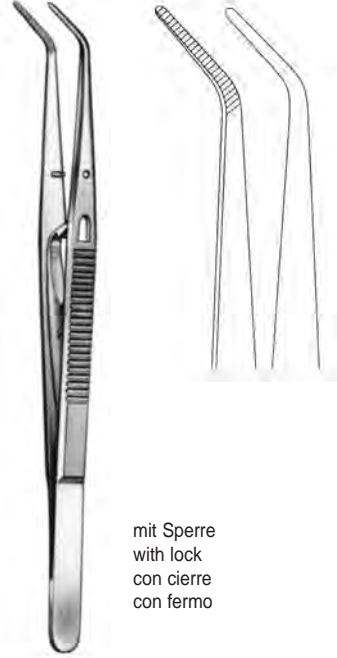

LONDON-COLLEGE  
11901-05  
15 cm 6"

mit Sperre  
with lock  
con cierre  
con fermo



MERIAM  
11910-01  
15 cm 6"

Mikrochirurgie-Pinzetten  
Microsurgery Forceps  
Pinzas para microcirugía  
Pinze per microchirurgia



12102-12  
12 cm, 4 <sup>3</sup>/<sub>4</sub>"



12103-12  
12 cm, 4 <sup>3</sup>/<sub>4</sub>"



12104-15  
15 cm, 6"



12105-15  
15 cm, 6"



12108-18  
18 cm, 7"



12109-18  
18 cm, 7"

Ultra-Light-Pinzetten  
 Ultra-Light-Forceps  
 Pinzas-Ultra-Ligera  
 Pinza-ultra-leggera

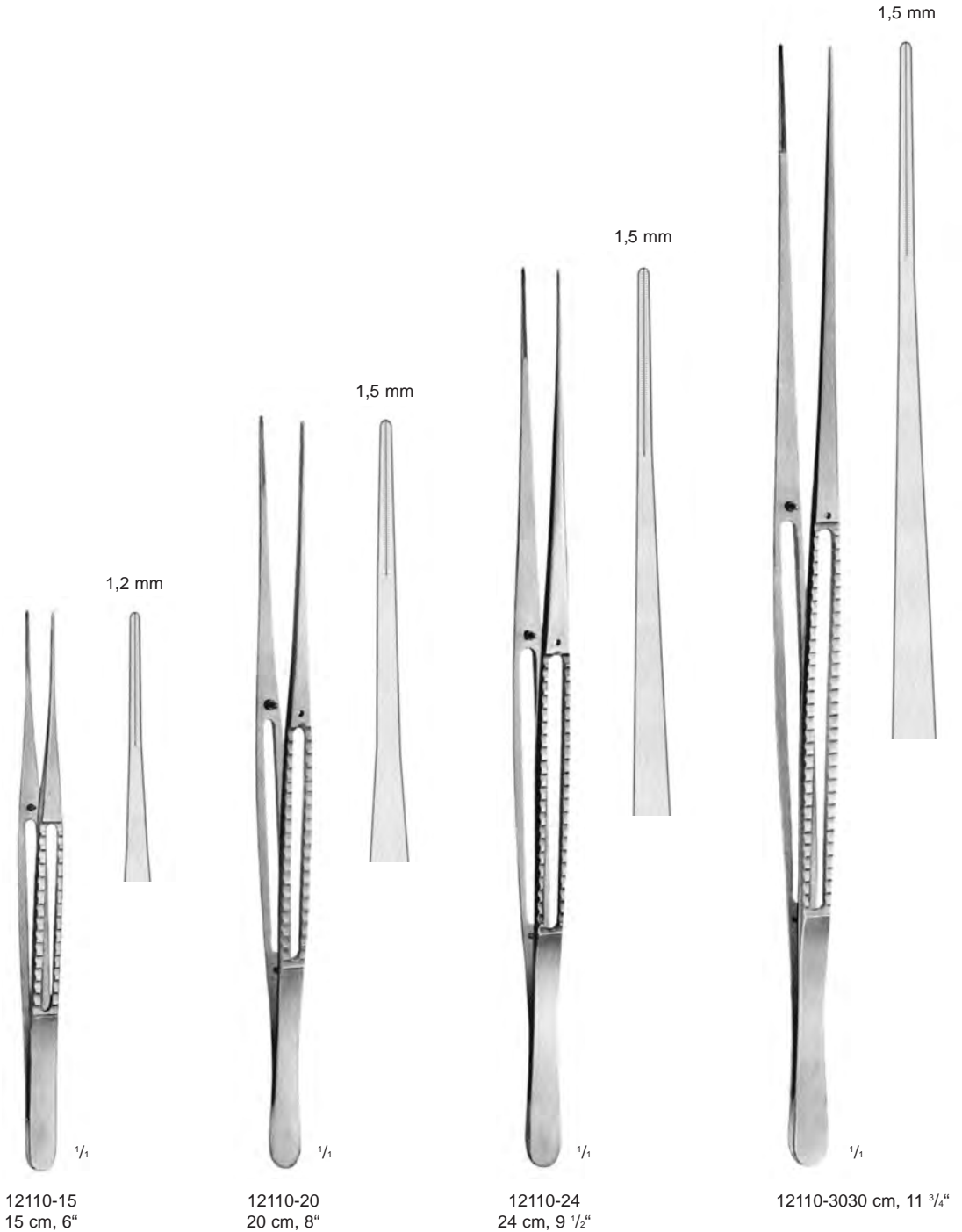



Mikrochirurgie-Pinzetten  
Microsurgery Forceps  
Pinzas para microcirugía  
Pinze per microchirurgia

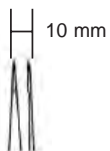
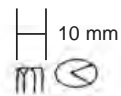

GOMEL  
12200-16  
16 cm, 6 1/4"



GOMEL  
12201-16  
16 cm, 6 1/4"

Tumorpinzetten  
 Tumor forceps  
 Pinzas para tumores  
 Pinze per tumori



YASARGIL  
 12291-22 – 12293-22  
 22 cm, 8 3/4"



YASARGIL  
 12295-22 – 12297-22  
 22 cm, 8 3/4"

Atraumatische Pinzetten  
 Atraumatic Tissue Forceps  
 Pinzas atraumáticas  
 Pinze atraumatiche



DE BAKEY  
 12302-16 16 cm, 6 1/4"  
 12302-20 20 cm, 8"  
 12302-24 24 cm, 9 1/2"



DE BAKEY  
 12306-16 16 cm, 6 1/4"  
 12306-20 20 cm, 8"  
 12306-24 24 cm, 9 1/2"  
 12306-30 30 cm, 11 3/4"



DE BAKEY  
 12308-16 16 cm, 6 1/4"  
 12308-20 20 cm, 8"  
 12308-24 24 cm, 9 1/2"  
 12308-30 30 cm, 11 3/4"



DE BAKEY  
 12309-16 16 cm, 6 1/4"  
 12309-20 20 cm, 8"  
 12309-24 24 cm, 9 1/2"  
 12309-30 30 cm, 11 3/4"



DE BAKEY  
 12304-16 16 cm, 6 1/4"  
 12304-20 20 cm, 8"  
 12304-24 24 cm, 9 1/2"  
 12304-30 30 cm, 11 3/4"



DE BAKEY  
 12310-16 16 cm, 6 1/4"  
 12310-20 20 cm, 8"  
 12310-24 24 cm, 9 1/2"  
 12310-30 30 cm, 11 3/4"

Atraumatische Pinzetten  
 Atraumatic Tissue Forceps  
 Pinzas atraumáticas  
 Pinze atraumatiche

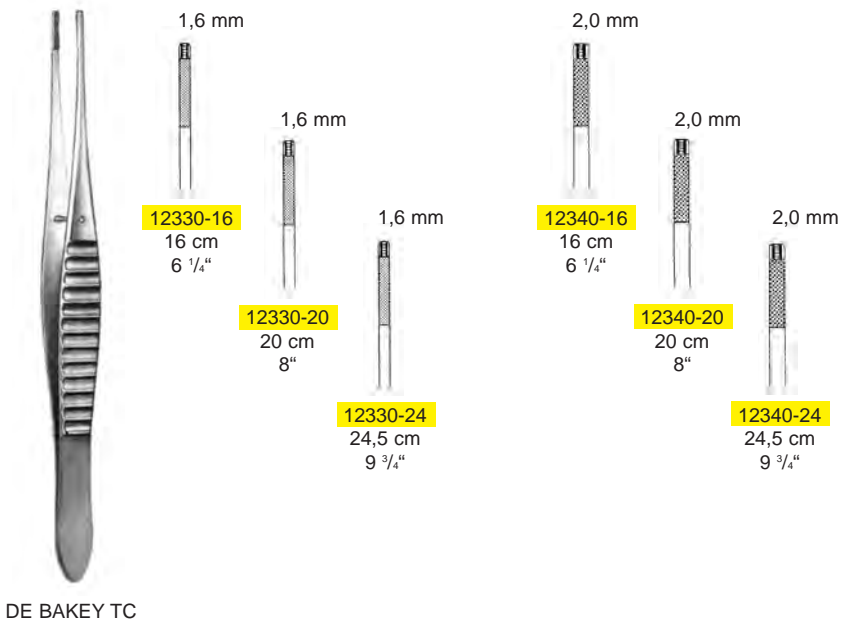
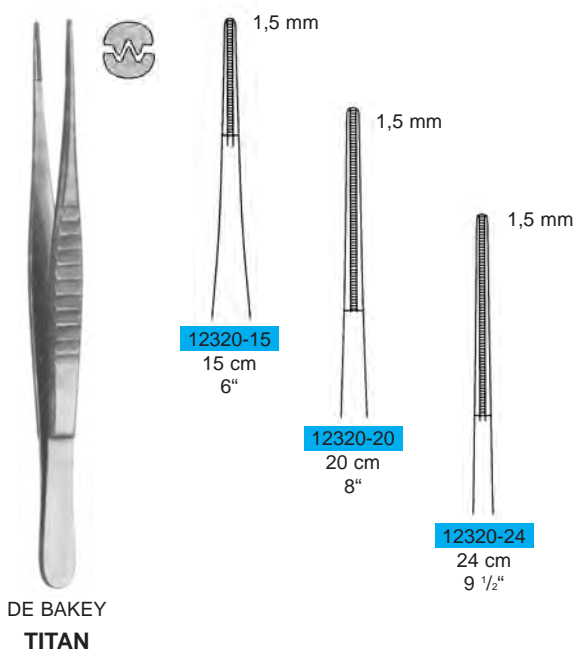

Atrauma-Bulldogklemmen  
 Atrauma-Bulldog Clamps  
 Clamps Atrauma Bulldog  
 Pinze Atrauma Bulldog

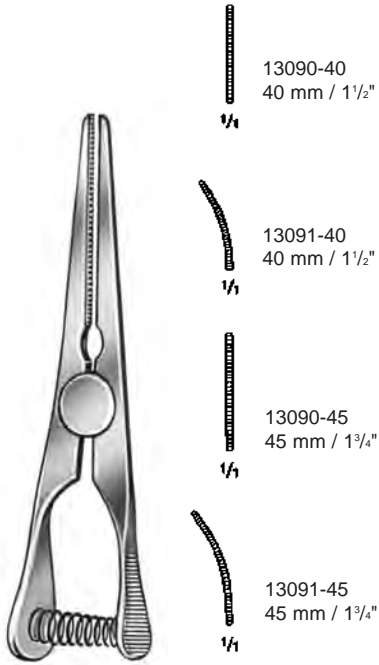

13090-40  
 40 mm  
 1 1/2"

13090-40  
 40 mm / 1 1/2"

13091-40  
 40 mm / 1 1/2"

13090-45  
 45 mm / 1 3/4"

13091-45  
 45 mm / 1 3/4"



13091-50  
 50 mm  
 2"

13090-50  
 50 mm / 2"

13091-50  
 50 mm / 2"



13098-06  
 57 mm  
 2 3/8"

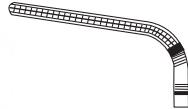

GLOVER



13099-07  
 73 mm  
 2 3/4"

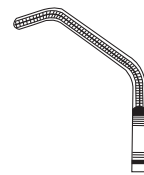

DE BAKEY

Mini-Bulldogklemmen  
 Mini Bulldog Clamps  
 Clamps Bulldog Mini  
 Pinze Bulldog Mini

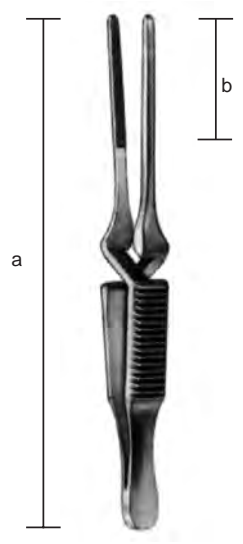

Diethrich

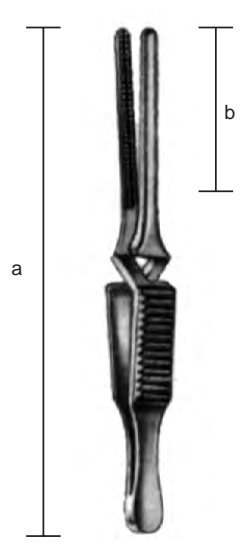
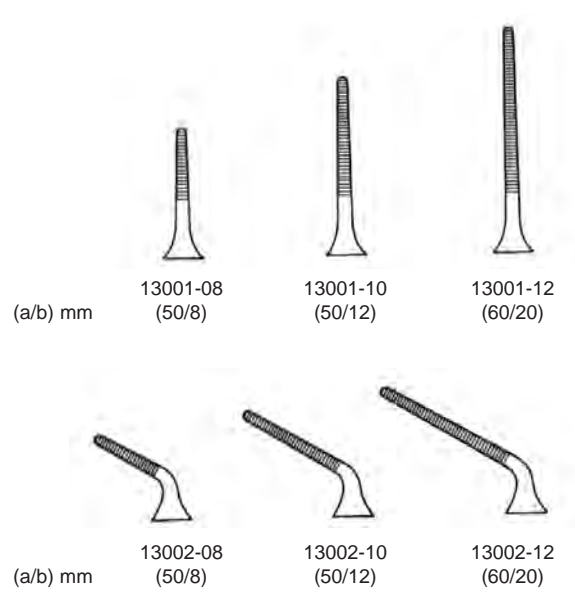

DeBaKey-Diethrich

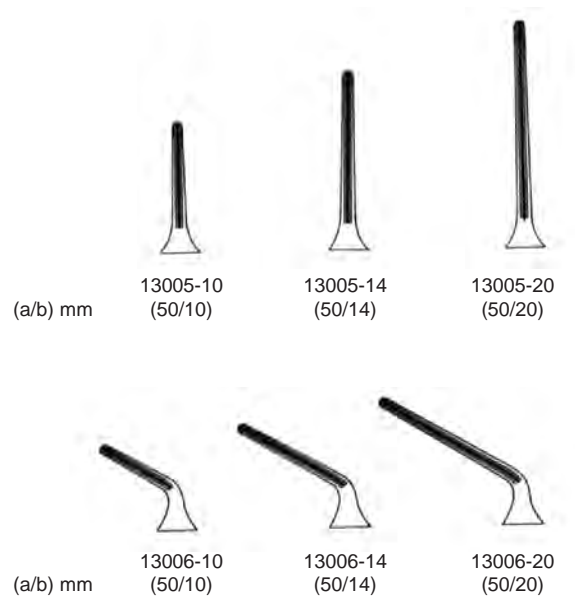



Titan-Atrauma-Bulldogklemmen  
Titanium Atrauma Bulldog Clamps  
Titan Clamp Bulldog  
Titan Pinze Bulldog

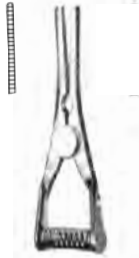

3 cm, 1.2"

Vene **13010-30**  
Arterie **13011-30**



3,5 cm, 1.4"

**13010-35**  
**13011-35**



4 cm, 1 1/2"

**13010-40**  
**13011-40**

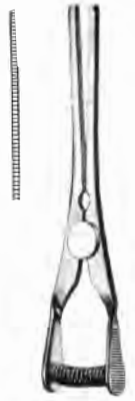

5 cm, 2"

**13010-50**  
**13011-50**



3 cm, 1.2"

Vena **13012-30**  
Arteria **13013-30**



3,5 cm, 1.4"

**13012-35**  
**13013-35**



4 cm, 1 1/2"

**13012-40**  
**13013-40**



5 cm, 2"

**13012-50**  
**13013-50**



3 cm, 1.2"

Vene **13014-30**  
Arterie **13015-30**



3,5 cm, 1.4"

**13014-35**  
**13015-35**



4 cm, 1 1/2"

**13014-40**  
**13015-40**



5 cm, 2"

**13014-50**  
**13015-50**

Atrauma-Bulldogklemmen  
 Atrauma Bulldog Clamps  
 Clamps Atrauma Bulldog  
 Pinze Atrauma Bulldog



DE BAKEY

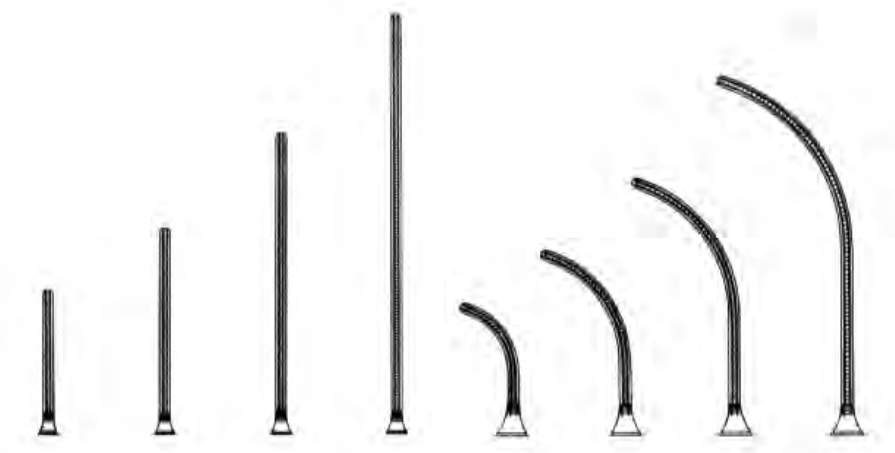

13092-07	13092-08	13092-10	13092-12	13093-07	13093-08	13093-10	13093-12
7,5 cm	8,5 cm	10,5 cm	12 cm	7 cm	8 cm	10 cm	11,5 cm
3"	3.4"	4"	4 3/4"	2 3/4"	8 1/8"	4"	4 1/2"



GLOVER



13096-06	13096-07	13096-09	13096-11	13097-06	13097-07	13097-09	13097-11
6 cm	7 cm	9 cm	11 cm	5,5 cm	6,5 cm	8,5 cm	10,5 cm
2 1/4"	2 3/4"	3 1/2"	4 3/8"	2"	2 1/2"	3 1/4"	4"



Gefäßklemmen, Bulldogklemmen, Arterienklemmen  
 Hemostatic Forceps  
 Pinzas hemostáticas  
 Pinze serrafina, Pinze emostatiche



**DIEFFENBACH**  
 13102-04 3,5 cm, 1.4"  
 13102-05 5,5 cm, 2.2"



gerade  
 straight  
 recta  
 rette

gebogen  
 curved  
 curva  
 curve



**DIEFFENBACH**  
 13103-04 3,5 cm, 1.4"  
 13103-05 5,5 cm, 2.2"

**JOHNS-HOPKINS**

13110-50	5,0 cm, 2"	13111-50
13110-55	5,5 cm, 2.2"	13111-55
13110-65	6,5 cm, 2.6"	13111-65
13110-70	7,0 cm, 2 3/4"	13111-70
13110-75	7,5 cm, 3"	13111-75
13110-90	9,0 cm, 3 1/2"	13111-90

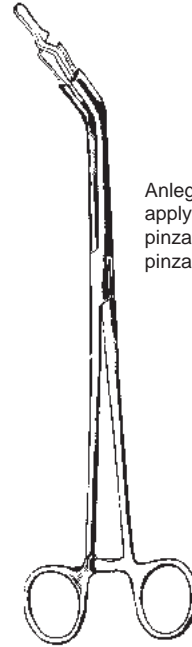

Anlegezange  
 applying forceps  
 pinza para poner  
 pinza applicatrice

13115-00  
 23 cm, 9"

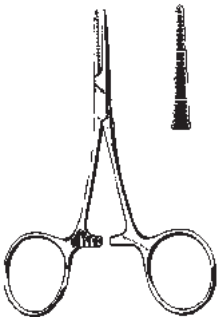

**HARTMANN**  
 13210-10  
 10 cm, 4"

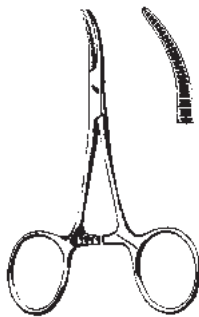

**HARTMANN**  
 13211-10  
 10 cm, 4"

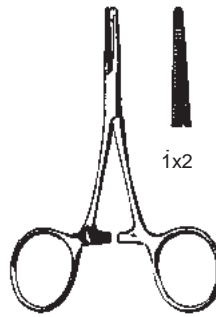

**HARTMANN**  
 13212-10  
 10 cm, 4"

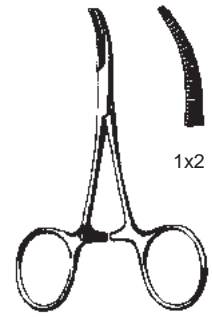

**HARTMANN**  
 13213-10  
 10 cm, 4"

**Micro-HARTMANN**  
 13214-10  
 10 cm, 4"

**Micro-HARTMANN**  
 13215-10  
 10 cm, 4"



Arterienklemmen  
Hemostatic Forceps  
Pinzas hemostáticas  
Pinze emostatiche

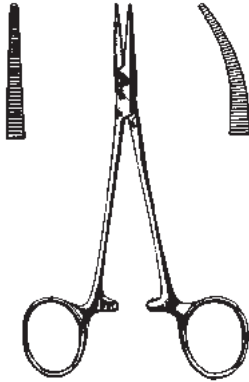

cm	TITAN	
12,5	5"	13224-12
14,0	5 1/2"	
18,0	7"	
21,0	8 1/4"	

TITAN	— HALSTED-MOSQUITO —	TITAN
13224-12	13220-12 12,5 cm, 5"	13221-12
	13220-14 14,0 cm, 5 1/2"	13221-14
	13220-18 18,0 cm, 7"	13221-18
	13220-21 21,0 cm, 8 1/4"	13221-21

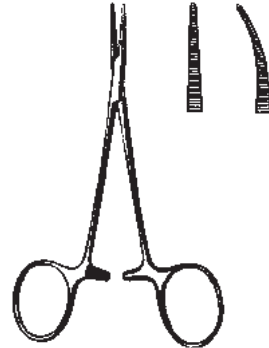

— HALSTED-MOSQUITO micro —	
13222-12 12,5 cm, 5"	13223-12
JACOBSON micro	
13226-12 12,0 cm, 4 3/4"	13227-12

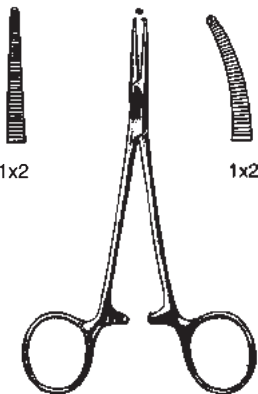

— HALSTED-MOSQUITO —	
13230-12 12,5 cm, 5"	13231-12
13230-14 14,0 cm, 5 1/2"	13231-14
13230-18 18,0 cm, 7"	13231-18
13230-21 21,0 cm, 8 1/4"	13231-21

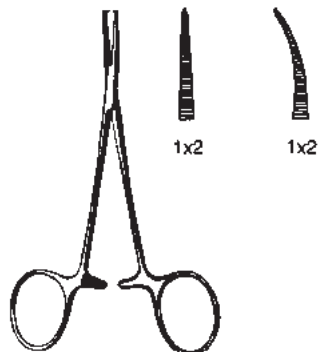

— HALSTED-MOSQUITO micro —	
13232-12	13233-12

Arterienklemmen  
 Hemostatic Forceps  
 Pinzas hemostáticas  
 Pinze emostatiche

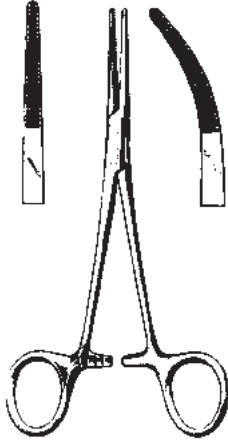

**KELLY**  
 13240-14 14 cm, 5 1/2" 13241-14  
 13240-18 18 cm, 7" 13241-18  
 13244-14 14 cm, 5 1/2" 13245-14  
 TITAN TITAN

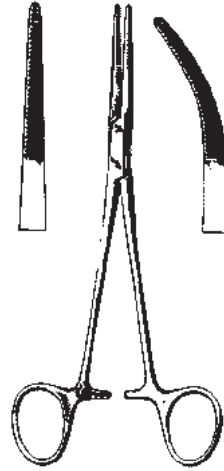

**KELLY-RANKIN**  
 13242-16 16 cm, 6 1/4" 13243-16

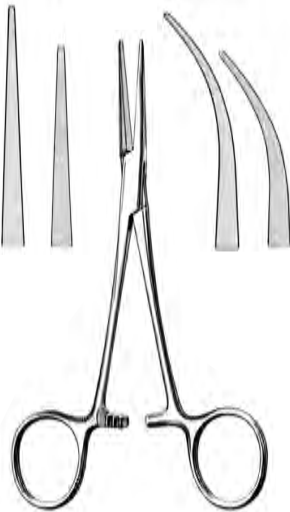

**COLLER-CRILE**  
 13256-14 14 cm, 5 1/2" 13257-14  
 13258-16 16 cm, 6 1/4" 13259-16

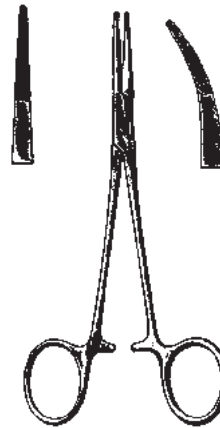

**PROVIDENCE-HOSPITAL**  
 13270-14 14 cm, 5 1/2" 13271-14

Arterienklemmen  
 Hemostatic Forceps  
 Pinzas hemostáticas  
 Pinze emostatiche

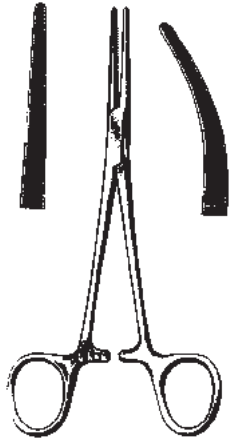

CRILE  
 13250-14 14 cm, 5 1/2" 13251-14  
 13250-18 18 cm, 7" 13251-18  
 13254-14 14 cm, 5 1/2" 13255-14  
 TITAN TITAN

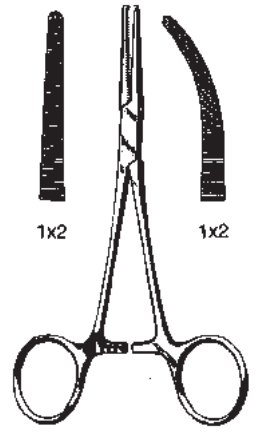

CRILE  
 13260-14 14 cm, 5 1/2" 13261-14

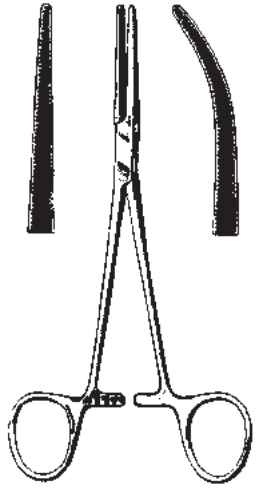

CRILE-RANKIN  
 13262-16 16 cm, 6 1/4" 13263-16

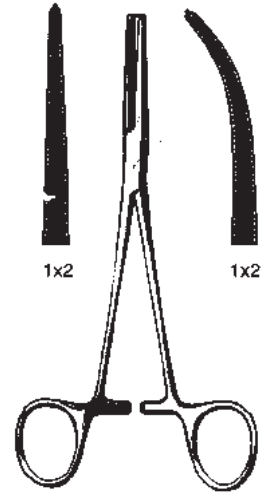

CRILE-RANKIN  
 13264-16 16 cm, 6 1/4" 13265-16

Arterienklemmen  
 Hemostatic Forceps  
 Pinzas hemostáticas  
 Pinze emostatiche

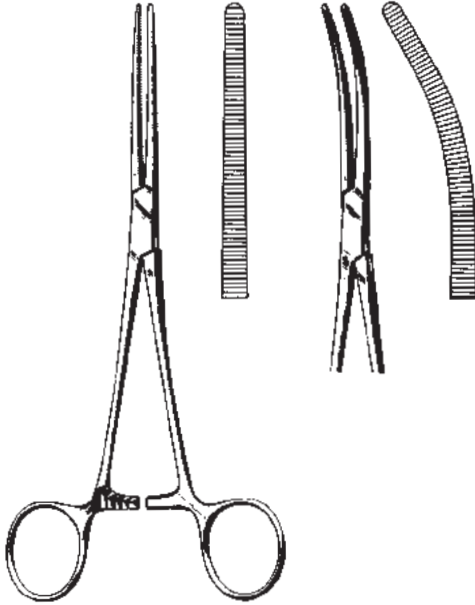

ROCHESTER-PEAN

13310-13	13 cm, 5 1/8"	13311-13
13310-14	14 cm, 5 1/2"	13311-14
13310-16	16 cm, 6 1/4"	13311-16
13310-18	18 cm, 7"	13311-18
13310-20	20 cm, 8"	13311-20
13310-22	22 cm, 8 3/4"	13311-22
13310-24	24 cm, 9 1/2"	13311-24
13310-26	26 cm, 10 1/4"	13311-26
13310-30	30 cm, 11 3/4"	13311-30

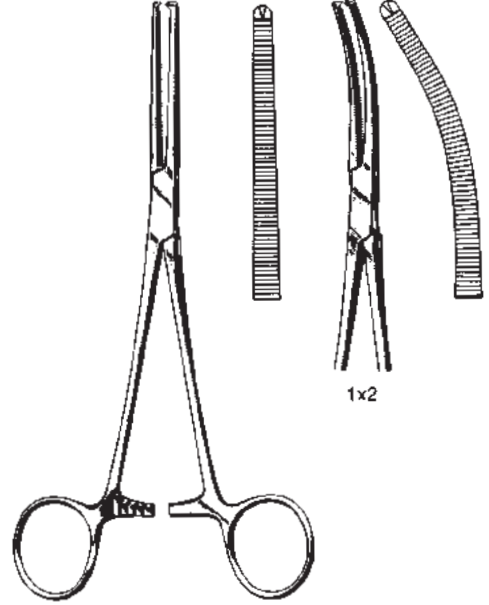

ROCHESTER-OSHSNER

13320-13	13 cm, 5 1/8"	13321-13
13320-14	14 cm, 5 1/2"	13321-14
13320-16	16 cm, 6 1/4"	13321-16
13320-18	18 cm, 7"	13321-18
13320-20	20 cm, 8"	13321-20
13320-22	22 cm, 8 3/4"	13321-22
13320-24	24 cm, 9 1/2"	13321-24
13320-26	26 cm, 10 1/4"	13321-26
13320-30	30 cm, 11 3/4"	13321-30

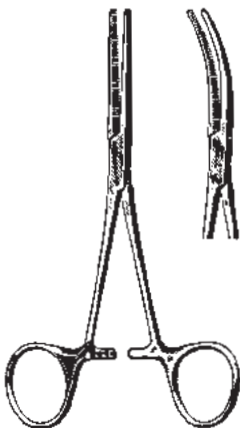

Delicate  
 Delicada  
 Fina

PEAN

13312-14	14 cm, 5 1/2"	13313-14
13312-16	16 cm, 6 1/4"	13313-16

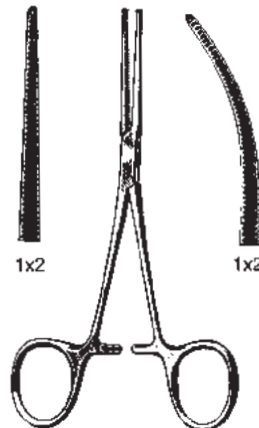

Delicate  
 Delicada  
 Fina

KOCHER

13322-14	14 cm, 5 1/2"	13323-14
13322-16	16 cm, 6 1/4"	13323-16

Arterienklemmen  
Hemostatic Forceps  
Pinzas hemostáticas  
Pinze emostatiche

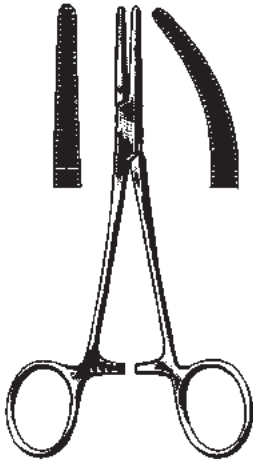

SPENCER-WELLS

13330-13	13 cm, 5"	13331-13
13330-15	15 cm, 6"	13331-15
13330-18	18 cm, 7"	13331-18
13330-20	20 cm, 8"	13331-20

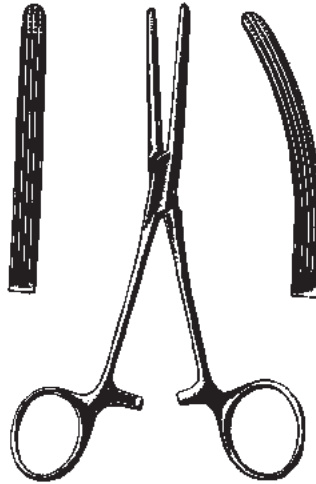

ROCHESTER-CARMALT

13340-16	16 cm, 6 1/4"	13341-16
13340-20	20 cm, 8"	13341-20

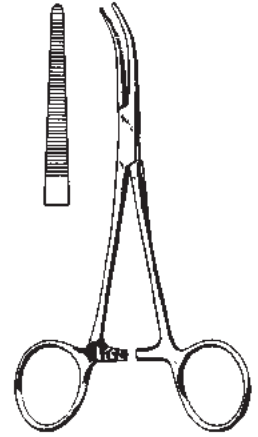

DANDY

13345-12	12 cm, 4 3/4"
13345-14	14 cm, 5 1/2"

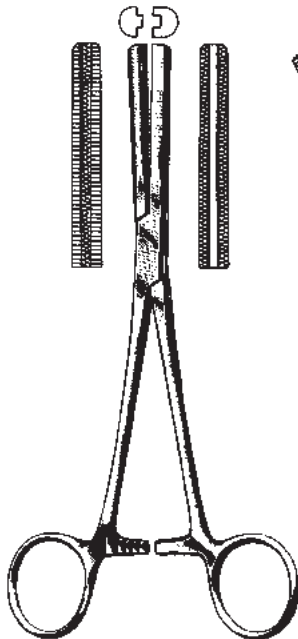

FERGUSSON

13350-16	16 cm, 6 1/4"	13351-16
13350-20	20 cm, 8"	13351-20

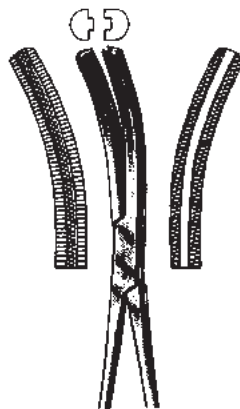

LOVELACE

13356-15	15,5 cm, 6"
----------	-------------

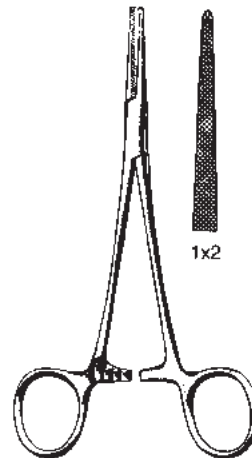

PENNINGTON

13358-15	15,5 cm, 6"
13358-20	20,0 cm, 8"

Fasszangen  
 Grasping Forceps  
 Pinza para agarrar órganos y tejidos  
 Pinze da presa

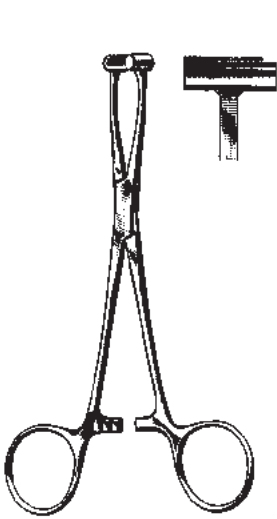

**PRATT**  
 13360-15 15 cm, 6"



**MARTEL**  
 13364-14 14 cm, 5 1/2"

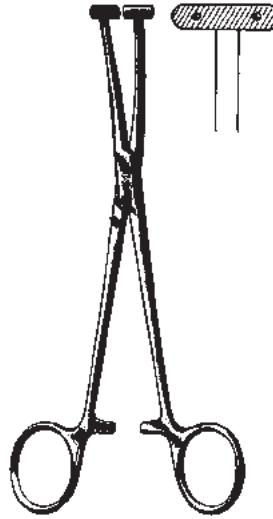

**WILLET MARTEL**  
 13366-19 19 cm, 7 1/2"

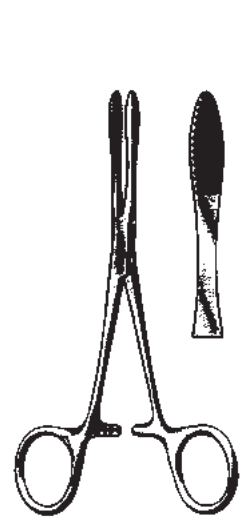

**PEAN**  
 13368-14 14 cm, 5 1/2"  
 13368-16 16 cm, 6 1/4"

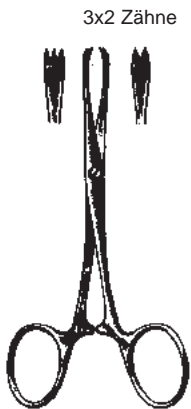

**CHAPUT**  
 13370-13  
 13 cm, 5 1/8"



**TUFFIER**  
 13372-13  
 13 cm, 5 1/8"

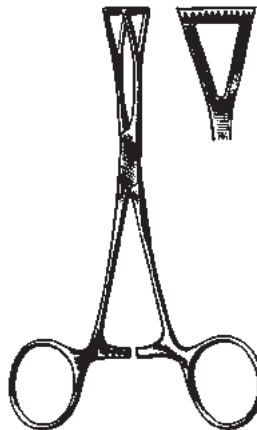

**COLLIN**  
 13374-14  
 14 cm, 5 1/2"

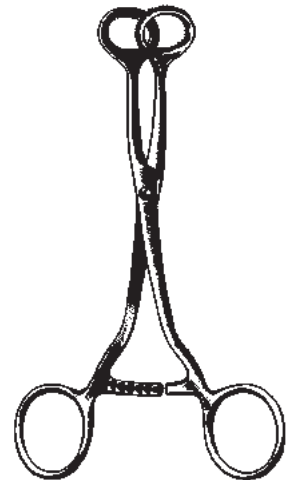

**COLLIN**  
 13376-16  
 16 cm, 6 1/4"

Organ- und Gewebefasszange, Arterienklemmen  
 Organ- and Tissue Grasping Forceps, Hemostatic Forceps  
 Pinza para agarrar órganos y tejidos, Pinzas hemostáticas  
 Pinza per tessuti e organi, Pinze emostatiche



REDA  
 ATRAUMA  
 13377-25 - 13377-26



13377-25  
 25 cm, 10"



13377-26  
 26 cm, 10 1/4"

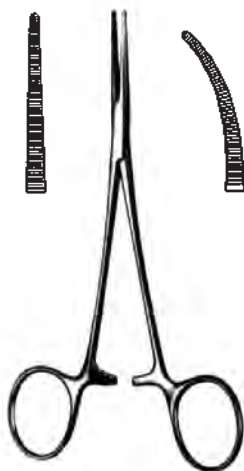

LERICHE  
 13380-15 15 cm, 6" 13381-15

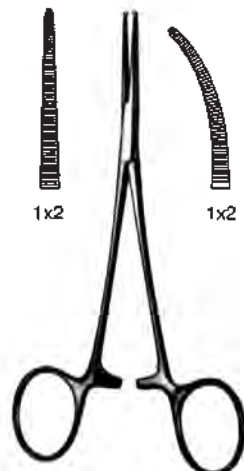

LERICHE  
 13382-15 15 cm, 6" 13383-15



Arterienklemmen  
 Hemostatic Forceps  
 Pinzas hemostáticas  
 Pinze emostatiche

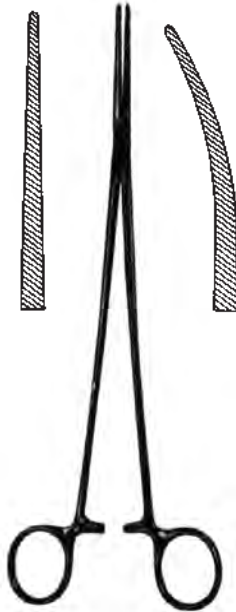

BENGOLEA

13384-20	20 cm, 8"	13385-20
13384-26	26 cm, 10 1/4"	13385-26

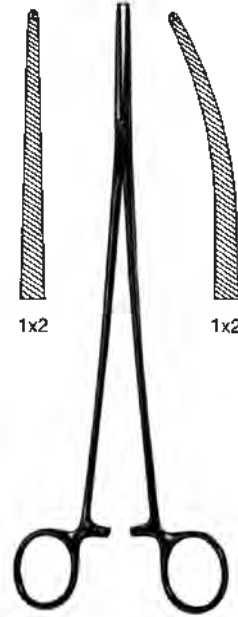

BENGOLEA

13386-20	20 cm, 8"	13387-20
13386-26	26 cm, 10 1/4"	13387-26

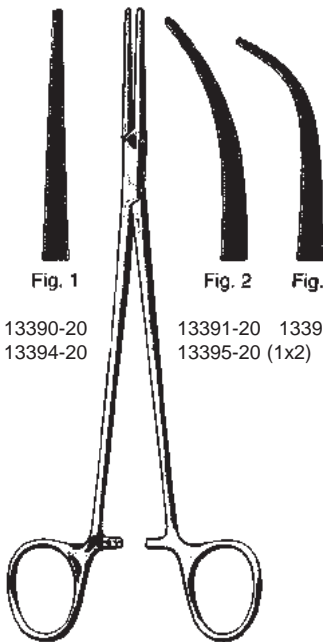

Fig. 1

Fig. 2

Fig. 3

13390-20	13391-20	13393-20
(1x2) 13394-20	13395-20 (1x2)	

HEISS  
 20 cm, 8"

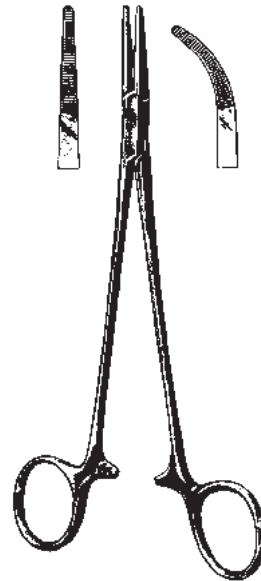

ADSON

13410-18	18,5 cm, 7 1/4"	13411-18
----------	-----------------	----------

Arterienklemmen  
 Hemostatic Forceps  
 Pinzas hemostáticas  
 Pinze emostatiche

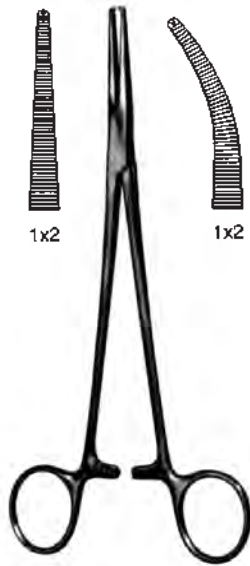

ADSON  
 13412-18 18,5 cm, 7 1/4" 13413-18



Fuchsig  
 13414-20 19 cm, 7 1/2"



ADSON BABY  
 13415-14 14,0 cm, 5 1/2"  
 13415-18 18,5 cm, 7 1/4"



NISSEN 13416-18 18,5 cm, 7 1/4"

Arterienklemmen  
 Hemostatic Forceps  
 Pinzas hemostáticas  
 Pinze emostatiche



**OVERHOLT-BABY**  
 13420-14  
 14 cm, 5 1/2"

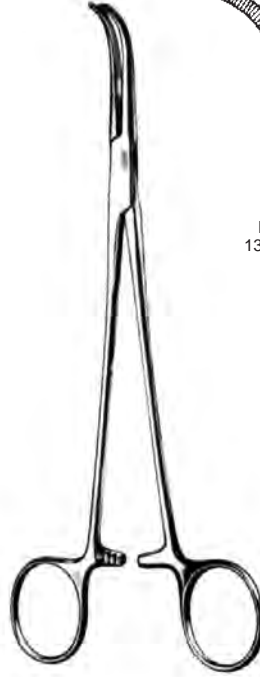

**OVERHOLT-GEISSENDOERFER**  
 21 cm, 8 1/4"

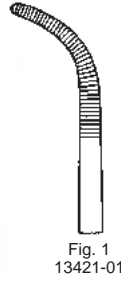

Fig. 1  
 13421-01

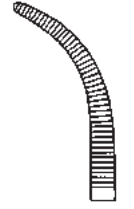

Fig. 2  
 13421-02



Fig. 3  
 13421-03

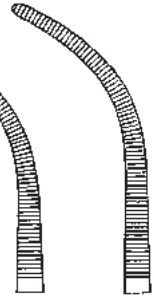

Fig. 4  
 13421-04

13425-02  
 26 cm  
 10 1/4"

13425-03  
 27 cm  
 10 1/2"

13425-04  
 27,5 cm  
 10,8"

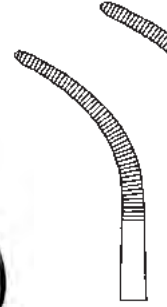

Fig. 5  
 13421-05



Fig. 6  
 13421-06

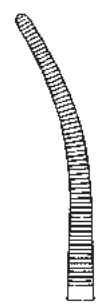

Fig. 7  
 13421-07

13425-05  
 27 cm  
 10 1/2"

13425-06  
 28 cm  
 11"



**OVERHOLT**



13422-00  
 21,5 cm  
 8 1/2"  
 Fig. ①



13422-01  
 21 cm  
 8 1/4"  
 ①



13422-02  
 22 cm  
 8 3/4"  
 ②



13422-03  
 23 cm  
 9"  
 ③



13422-06  
 22,5 cm  
 8,9"  
 ⑥



Arterienklemmen  
Hemostatic Forceps  
Pinzas hemostáticas  
Pinze emostatiche



OVERHOLT-MIXTER  
13428-21  
21,5 cm, 8 1/2"



GEMINI



13431-13  
13 cm  
5 1/8"

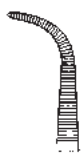

13431-16  
16 cm  
6 1/4"

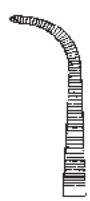

13431-18  
18 cm  
7"



13431-20  
20 cm  
8"



13431-23  
23 cm  
9"



13431-25  
25 cm  
10"

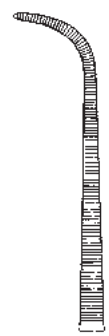

13431-28  
28 cm  
11"



Arterienklemmen  
Hemostatic Forceps  
Pinzas hemostáticas  
Pinze emostatiche



BIRKETT



13432-19  
18,5 cm  
7 1/4"



13433-19  
18,5 cm  
7 1/4"



BRIDGE



13434-28  
27,5 cm  
10 3/4"



13435-28  
27,5 cm  
10 3/4"



MIXTER



13438-01  
18,5 cm  
7 1/4"



13438-02  
21 cm  
8 1/4"



13438-03  
21,5 cm  
8 1/2"



13438-04  
22 cm  
8 3/4"

Arterienklemmen  
Hemostatic Forceps  
Pinzas hemostáticas  
Pinze emostatiche



RUMEL  
23 cm, 9"



13441-01

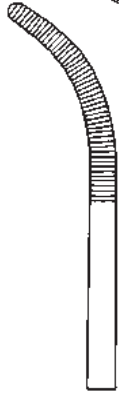

13441-02

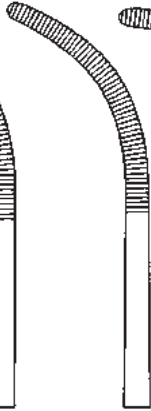

13441-03

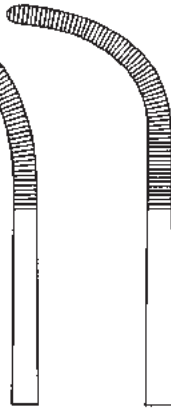

13441-04



WIKSTROEM  
13447-20  
20,5 cm, 8"



13442-21 21 cm, 8 1/4"  
13442-26 26 cm, 10 1/4"



TOENNIS



21 cm, 8 1/4" 13443-21  
26 cm, 10 1/4" 13443-26

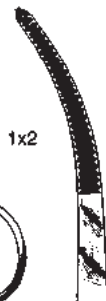

1x2

21 cm, 8 1/4" 13445-21  
26 cm, 10 1/4" 13445-26

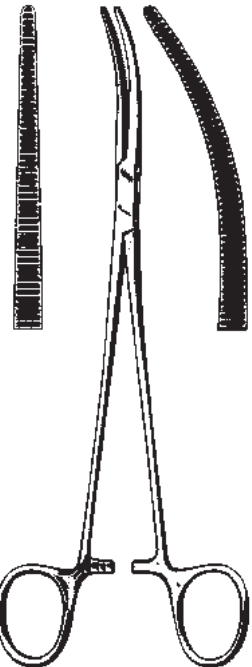

ROBERTS 13448-22 22

cm, 8 3/4" 13449-22

13444-21 21 cm, 8 1/4"  
13444-26 26 cm, 10 1/4"

1x2

Arterienklemmen  
 Hemostatic Forceps  
 Pinzas hemostáticas  
 Pinze emostatiche

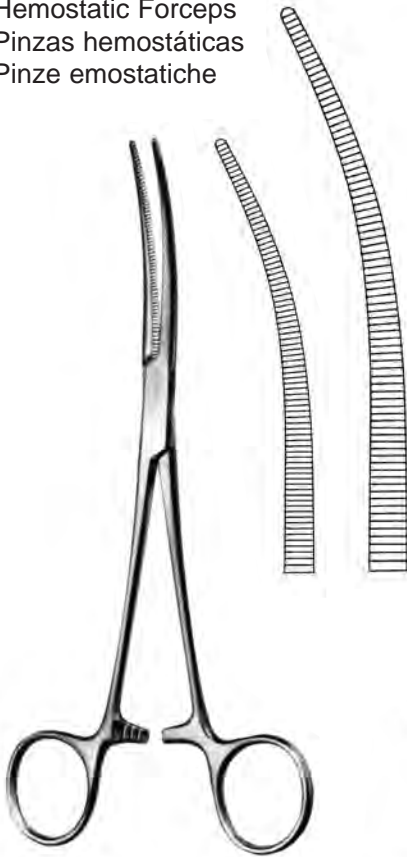

**CRAFOORD**  
 13453-18 18 cm, 7"  
 13453-24 24 cm, 9 1/2"

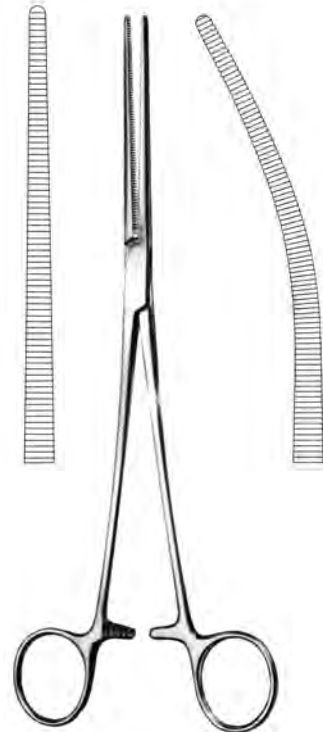

**SAROT**  
 13450-24 24 cm, 9 1/2" 13451-24



**ZENKER**

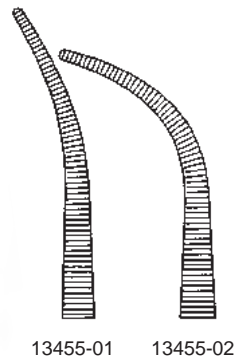

13455-01 13455-02

Arterienklemmen  
 Hemostatic Forceps  
 Pinzas hemostáticas  
 Pinze emostatiche

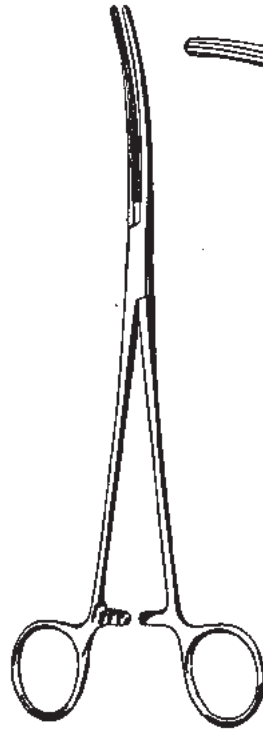

CRAFOORD-SELLORS  
 24 cm, 9 1/2"

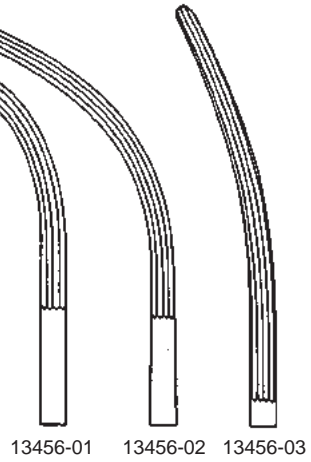

13456-01    13456-02    13456-03



LAWRENCE  
 13457-28 28 cm, 11"



MEEKER  
 13459-18 18 cm, 7"  
 13459-28 28 cm, 11"



Arterienklemmen  
 Hemostatic Forceps  
 Pinzas hemostáticas  
 Pinze emostatiche

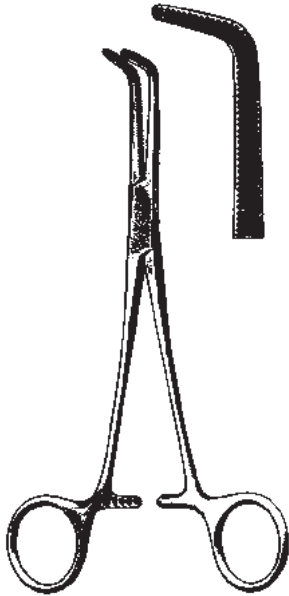

MIXTER  
 13471-14 14 cm, 5 1/2"  
 13471-16 16 cm, 6 1/4"  
 13471-18 18 cm, 7"  
 13471-23 23 cm, 9"

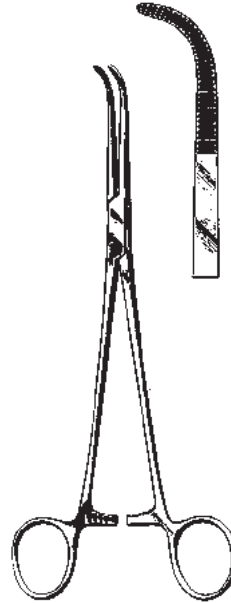

MIXTER  
 13473-22  
 22 cm, 8 3/4"



KANTROWITZ

13474-19 19 cm, 7 1/2"  
 " 13474-24 24 cm, 9 1/2"  
 " 13474-26 26 cm, 10 1/4"

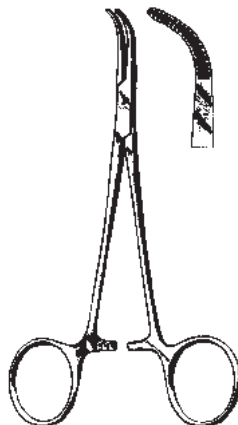

MIXTER BABY  
 13475-14  
 14 cm, 5 1/2"



MIXTER BABY  
 13475-18  
 18 cm, 7"

Arterienklemmen  
Hemostatic Forceps  
Pinzas hemostáticas  
Pinze emostatiche

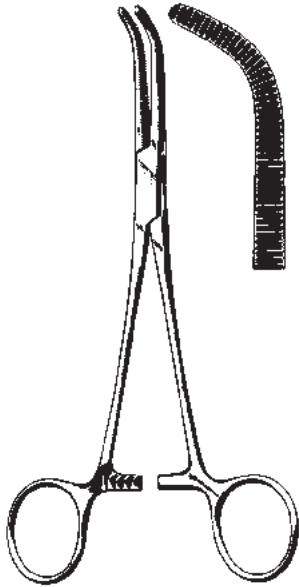

MIXTER-O'SHAUGHNESSY  
13477-15 15,5 cm, 6"  
13477-19 19,0 cm, 7 1/2"



MIXTER

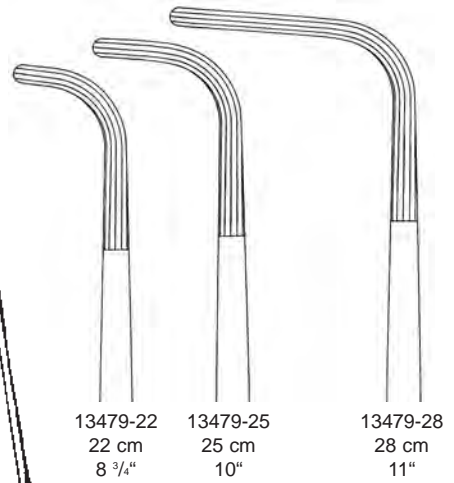

13479-22  
22 cm  
8 3/4"

13479-25  
25 cm  
10"

13479-28  
28 cm  
11"

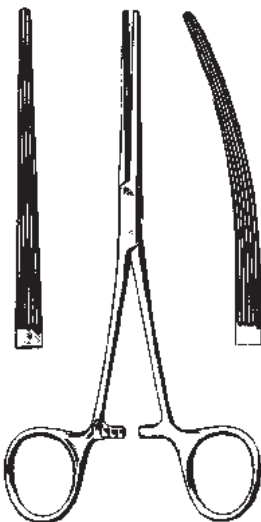

BAINBRIDGE  
13480-15 15,0 cm, 6" 13481-15  
13480-18 18,5 cm, 7 1/4" 13481-18

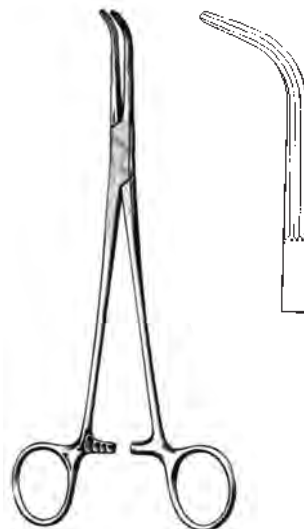

LAHEY  
13491-19 19 cm, 7 1/2"

Arterienklemmen  
 Hemostatic Forceps  
 Pinzas hemostáticas  
 Pinze emostatiche

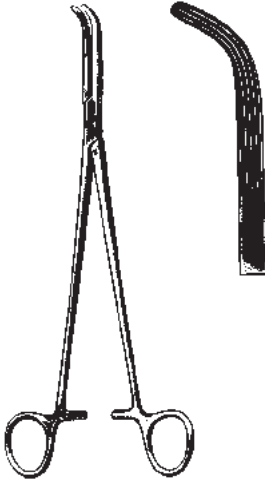

LAHEY  
 13493-23 23 cm, 9"

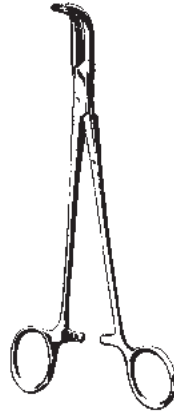

LOWER  
 13495-18 18 cm, 7"

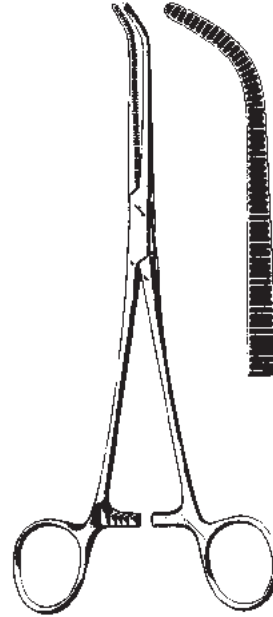

JOHNS-HOPKINS  
 13497-20 20 cm, 8"

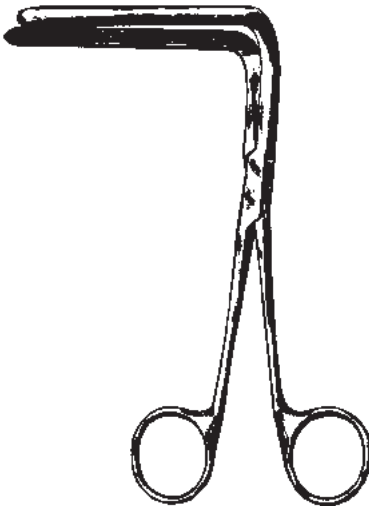

MIXTER  
 13499-16  
 16,5 cm, 6 1/2"

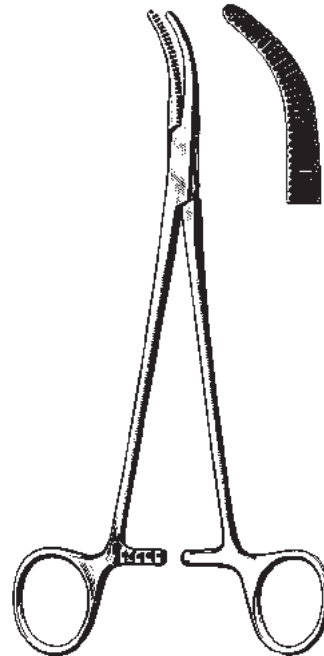

MOYNIHAN  
 13501-23  
 23 cm, 9"

Arterienklemmen  
 Hemostatic Forceps  
 Pinzas hemostáticas  
 Pinze emostatiche



DESJARDINS  
 13503-21 21 cm, 8 1/4"

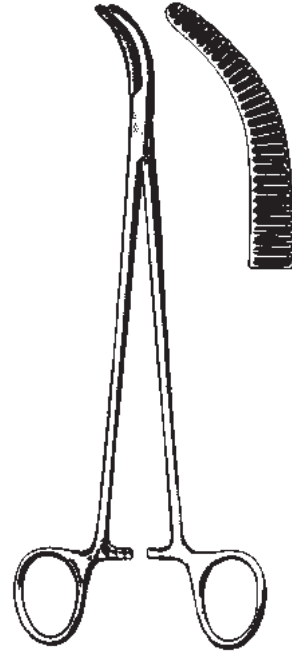

DESJARDINS  
 13505-21 21 cm, 8 1/4"

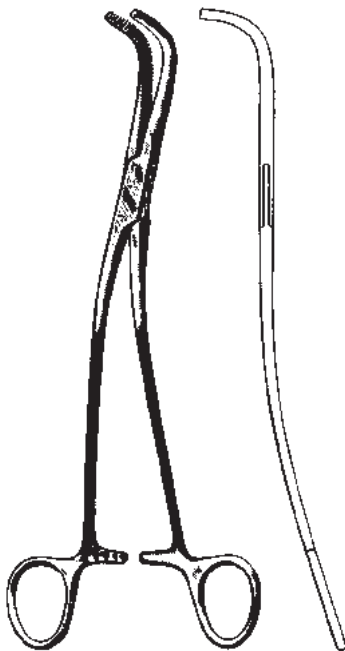

GRAY

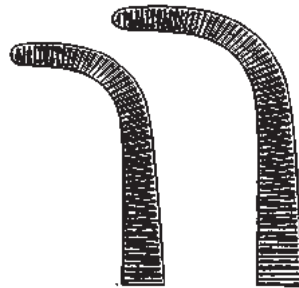

13507-22  
 22 cm  
 8 3/4"

13507-23  
 23 cm  
 9"

Arterienklemmen  
 Hemostatic Forceps  
 Pinzas hemostáticas  
 Pinze emostatiche

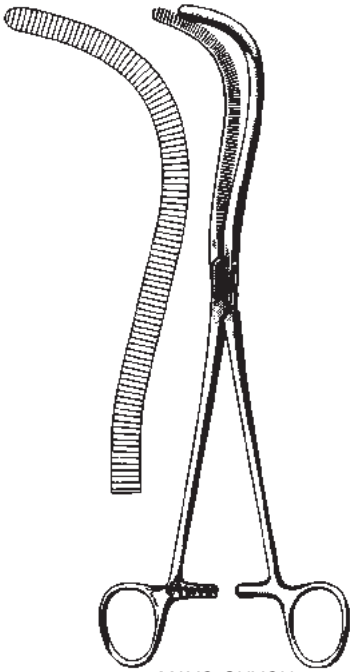

MAYO-GUYON  
 13513-23  
 23 cm, 9"

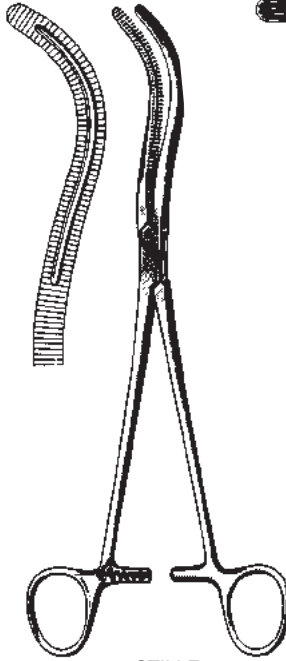

STILLE  
 13515-23  
 23 cm, 9"

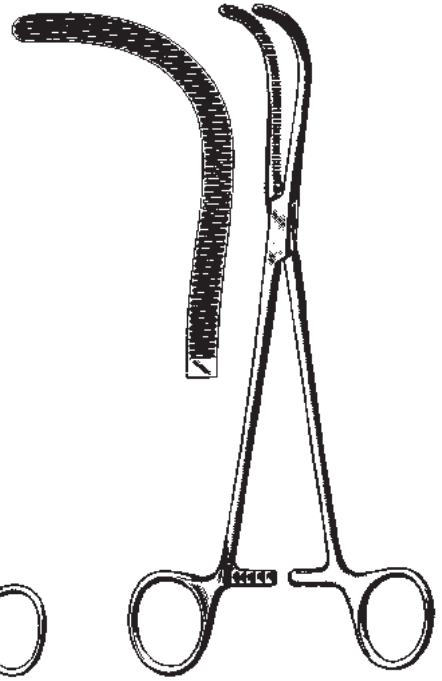

GUYON  
 13517-23  
 23 cm, 9"

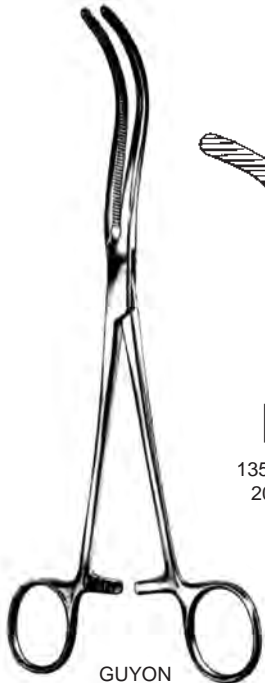

GUYON

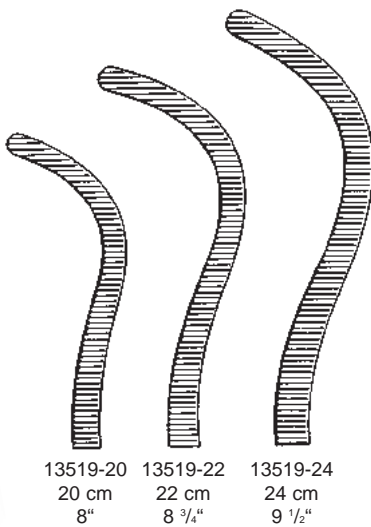

13519-20  
 20 cm  
 8"

13519-22  
 22 cm  
 8 3/4"

13519-24  
 24 cm  
 9 1/2"



GUYON



13520-23  
 23 cm  
 9"

13520-24  
 24 cm  
 9 1/2"

ATRAUMA

Hysterektomieklemmen  
 Hysterectomy Forceps  
 Pinzas para hysterectomia  
 Pinze per isterectomia

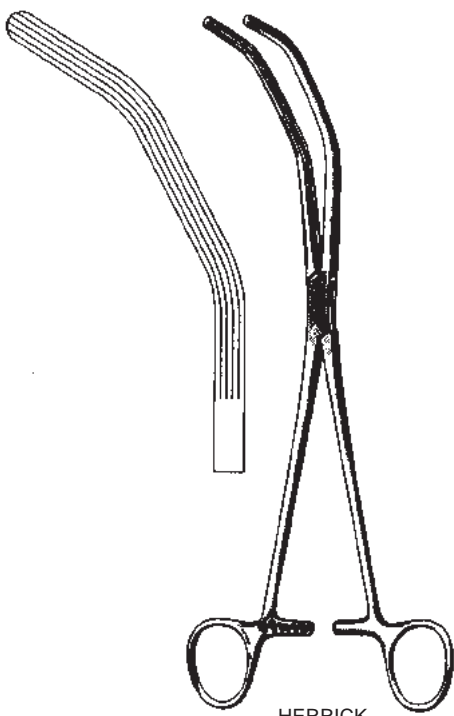

**HERRICK**  
 13523-23  
 23 cm, 9"

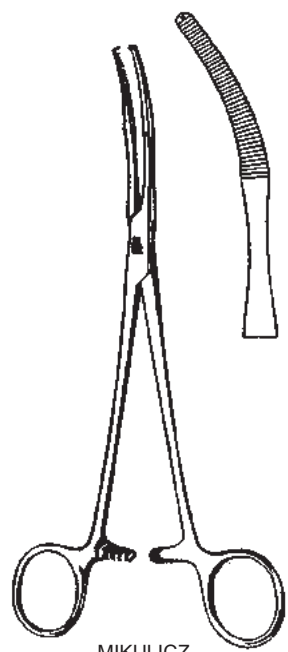

**MIKULICZ**  
 13551-14 14 cm, 5 1/2" BABY  
 13551-18 18 cm, 7"  
 13551-20 20 cm, 8"

Peritoneum-Klemme  
 Peritoneum Forceps  
 Pinzas para peritoneo  
 Pinze peritoneali

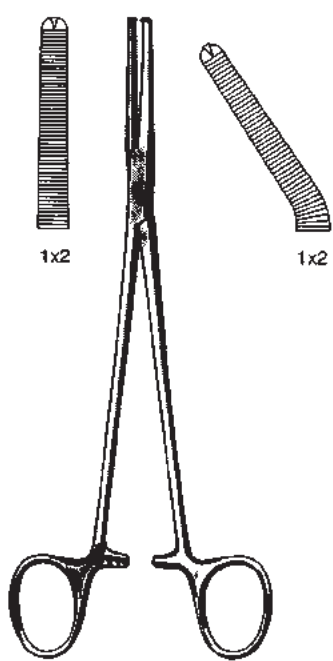

**PHANEUF**  
 13554-21 21 cm, 8 1/4" 13555-21



**MIKULICZ**  
 13556-24 24 cm, 9 1/2"

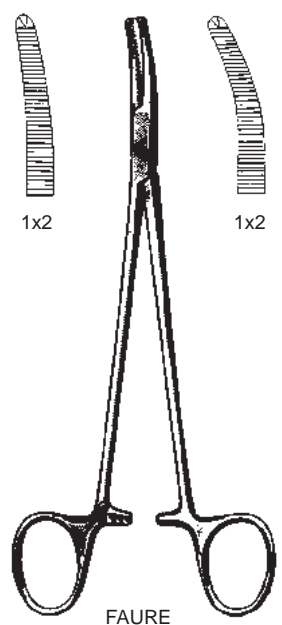

**FAURE**  
 13561-20 20 cm, 8" 13563-20

Hysterektomieklemmen  
 Hysterectomy Forceps  
 Pinzas para histerectomía  
 Pinze per isterectomia



WERTHEIM  
 13570-23  
 23,5 cm, 9 1/4"

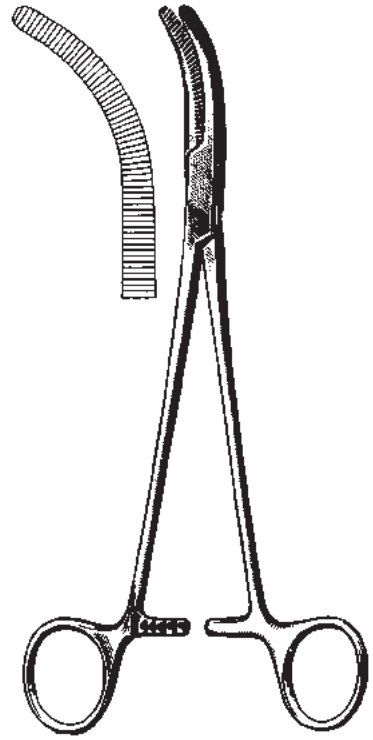

WERTHEIM  
 13571-25  
 25 cm, 10"

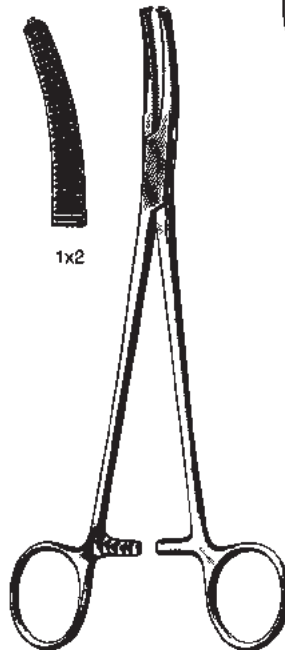

1x2

WERTHEIM

Hysterektomieklemmen  
 Hysterectomy Forceps  
 Pinzas para histerectomía  
 Pinze per isterectomia



SEGOND-LANDAU  
 13574-24  
 24 cm, 9 1/2"



SEGOND  
 13575-24  
 24 cm, 9 1/2"

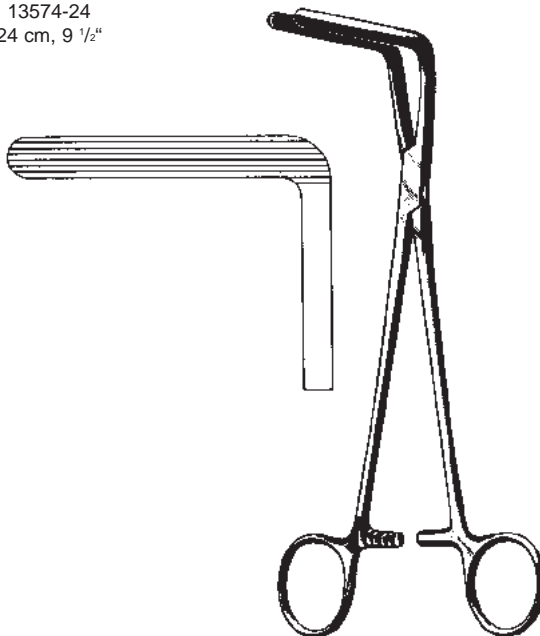

WERTHEIM-CULLEN 13579-21 21,5 cm, 8 1/2"



Hysterektomieklemmen  
 Hysterectomy Forceps  
 Pinzas para histerectomía  
 Pinze per isterectomia

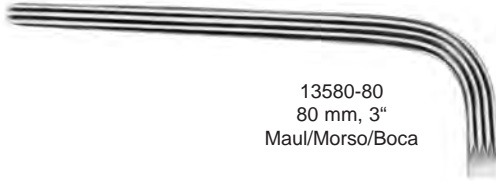

13580-80  
 80 mm, 3"  
 Maul/Morso/Boca



13580-60  
 60 mm, 2 1/4"  
 Maul/Morso/Boca



23 cm, 9"



13591-20



13593-20



HEANEY  
 20 cm, 8"

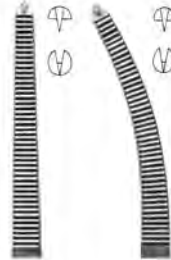

HOLZBACH  
 13598-24 24 cm, 9 1/2" 13599-24

Hysterektomieklemmen  
 Hysterectomy Forceps  
 Pinzas para histerectomía  
 Pinze per isterectomia

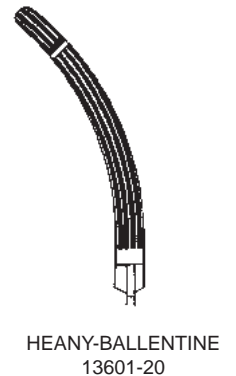
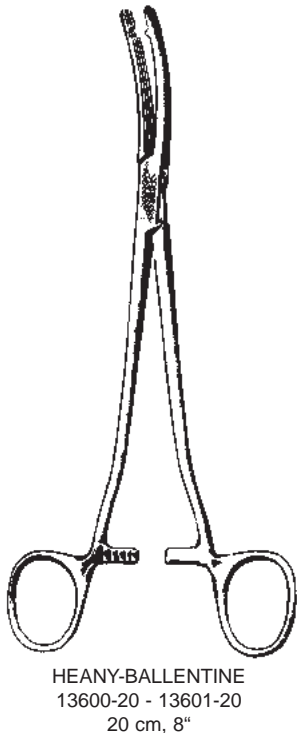
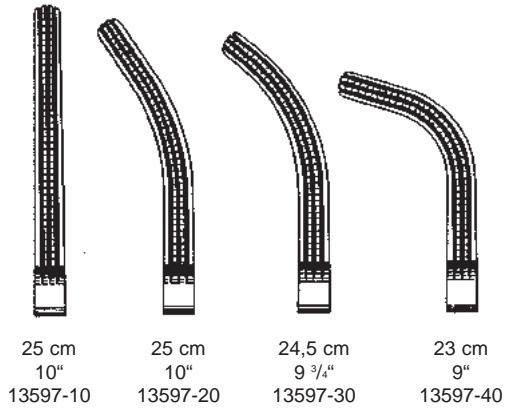
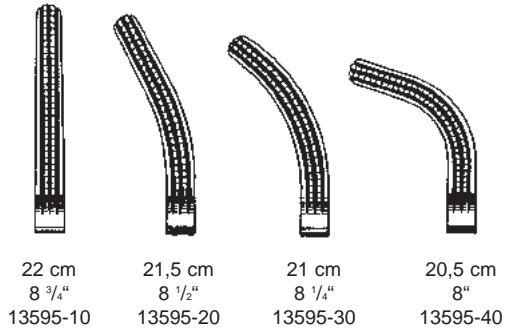

Hysterektomieklemmen  
Hysterectomy Forceps  
Pinzas para histerectomía  
Pinze per isterectomia



WERTHEIM  
13605-26  
25,5 cm, 10"

Schlauchklemmen  
 Tubing Clamps  
 Pinzas cierra-tubos  
 Pinze serratubi



KLINIKUM BERLIN  
 13702-14  
 14,5 cm, 5 3/4"



13710-15  
 15 cm, 6"



13710-18  
 18 cm, 7"



13710-20  
 20 cm, 8"



PRESBYTERIAN  
 13704-16 16 cm, 6 1/4"  
 13704-18 18 cm, 7"



13712-15  
 15 cm, 6"



13712-18  
 18 cm, 7"



13712-20  
 20 cm, 8"

Schlauchklemme  
Tubing clamps  
Pinzas cierra-tubos  
Pinze serratubi a rulli

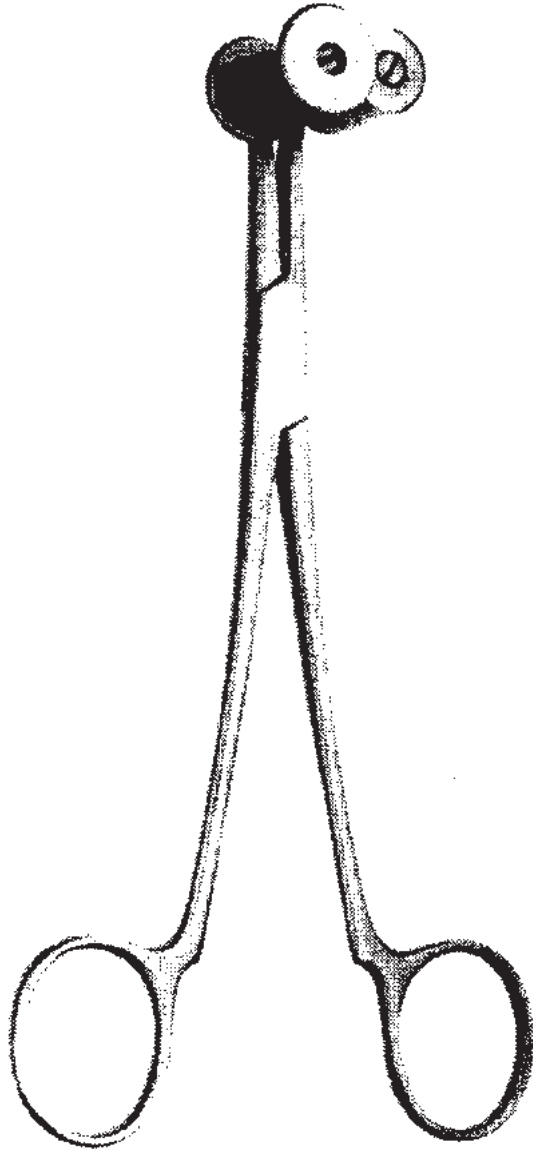

BÜLOW-GUNAR-HEY  
13720-18 18 cm, 7"

Tuchklemmen  
Towel Forceps  
Pinzas de campos  
Pinze fissateli



SCHAEDDEL  
15101-09  
9 cm, 3 1/2"



JONES  
15103-07  
7 cm, 2 3/4"  
15103-09  
9 cm, 3 1/2"



JONES-CLIP  
15105-09  
9 cm, 3 1/2"

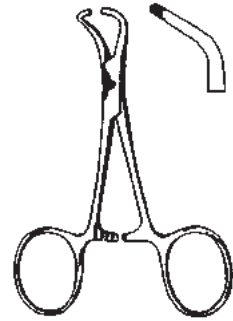

TOHUKU  
15107-10 10 cm, 4"  
15107-13 13 cm, 5 1/8"

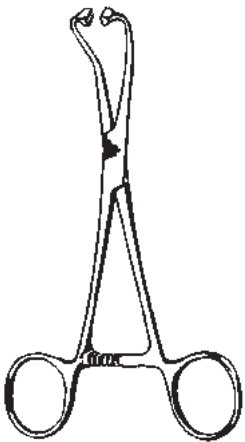

PEERS  
15108-14  
14,5 cm, 5 3/4"

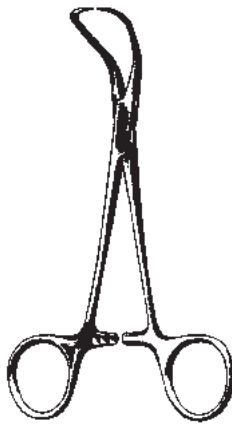

BACKHAUS  
15111-09 9 cm, 3 1/2"  
15111-11 11 cm, 4 3/8"  
15111-13 13 cm, 5 1/8"  
15111-15 15 cm, 6"



BACKHAUS-CLIP  
15115-11  
11 cm, 4 3/8"

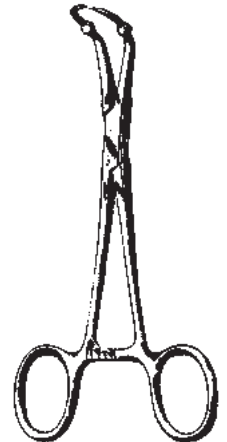

ROEDER  
15117-13  
13 cm, 5 1/8"

Tuchklemmen  
Towel Forceps  
Pinzas de campos  
Pinze fissateli

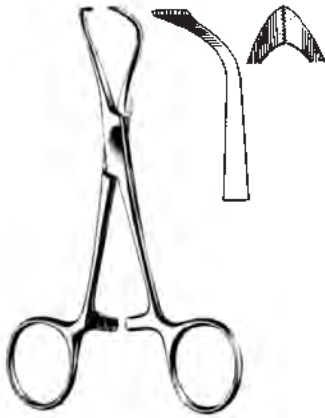

**LORNA**  
15121-11 11 cm, 4  $\frac{3}{8}$ "  
15121-13 13 cm, 5  $\frac{1}{8}$ "



**BALL AND SOCKET**  
15123-11 11 cm, 4  $\frac{3}{8}$ "  
15123-13 13 cm, 5  $\frac{1}{8}$ "



15125-14  
14,5 cm, 5  $\frac{3}{4}$ "

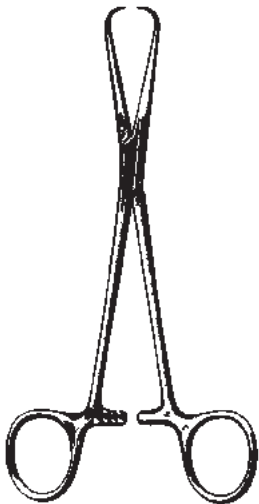

**BERNHARD**  
15140-16  
16,5 cm, 6  $\frac{1}{2}$ "

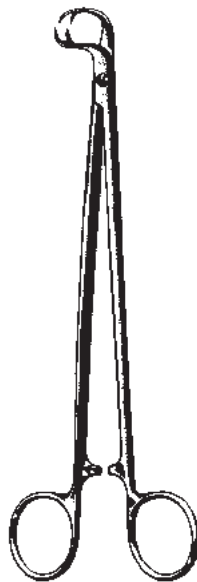

**MOYNIHAN**  
15150-19  
19 cm, 7  $\frac{1}{2}$ "



**DOYEN**  
15161-18  
18 cm, 7"

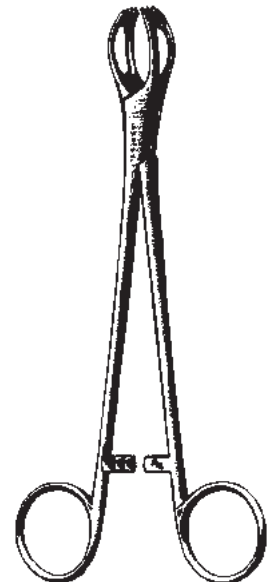

**LANE**  
15164-15 15 cm, 6"  
15164-20 20 cm, 8"

Tupferzangen  
 Dressing Forceps  
 Pinzas porta-esponjas  
 Pinze per medicatura

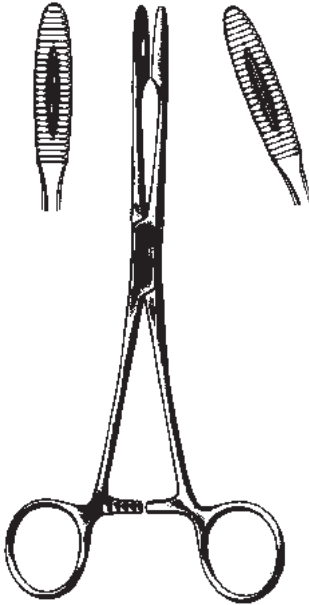

**GROSS-MAIER**  
 17110-20 20 cm, 8" 17111-20  
 17110-25 25 cm, 10" 17111-25

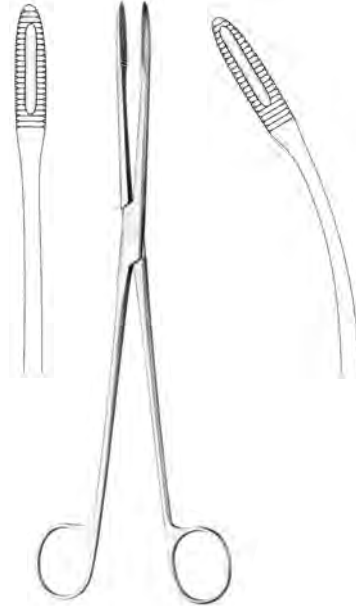

**GROSS-MAIER**  
 17112-20 20 cm, 8" 17113-20  
 17112-25 25 cm, 10" 17113-25

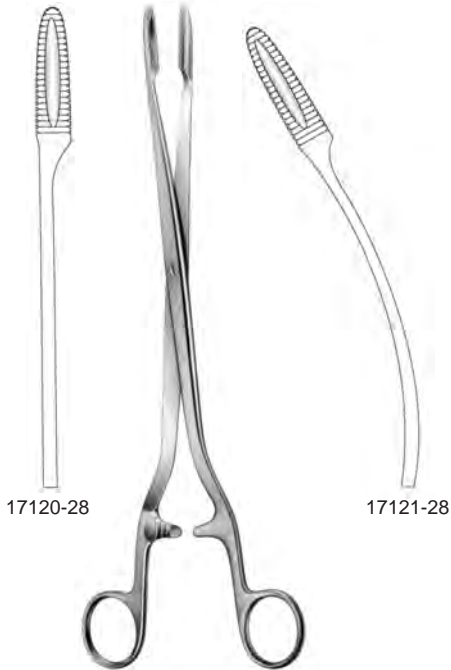

17120-28

17121-28

**SIMS-MAIER**  
 28 cm, 11"



**DUPLAY KORNZANGE**  
 17131-21 21 cm, 8 1/4"





**MAST.SH-GERMANY**

Tupferzangen  
Dressing Forceps  
Pinzas porta-esponjas  
Pinze per medicatura



KORNZANGE  
17133-17 17 cm, 6 <sup>3</sup>/<sub>4</sub>"

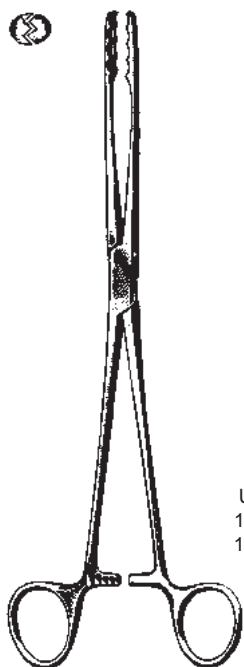

ULRICH  
17160-22  
17160-25



22 cm, 8 <sup>3</sup>/<sub>4</sub>"  
25 cm, 10"

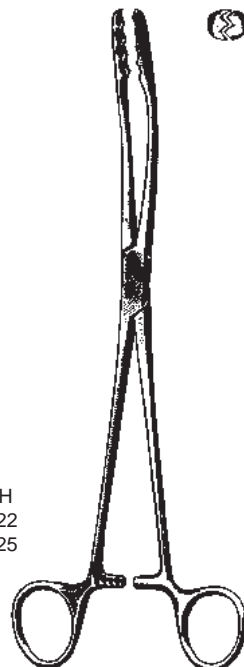

ULRICH  
17161-22  
17161-25

Tupferzange  
 Sponge Holding Forceps  
 Pinzas porta esponjas  
 Pinze ad anelli per tamponi e spugne

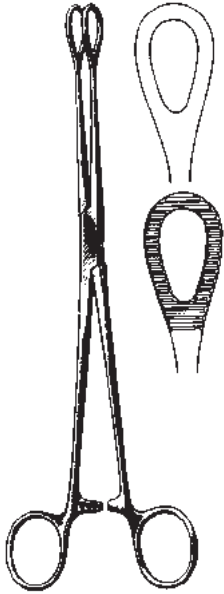

FOERSTER

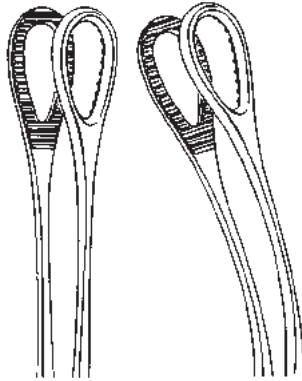

17170-18  
 17170-20  
 17170-25



17171-18 18 cm, 7"  
 17171-20 20 cm, 8"  
 17171-25 25 cm, 10"

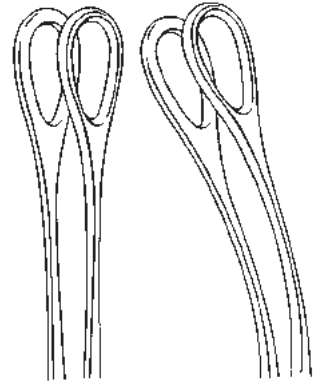

17172-18  
 17172-25  
 17173-18  
 17173-25

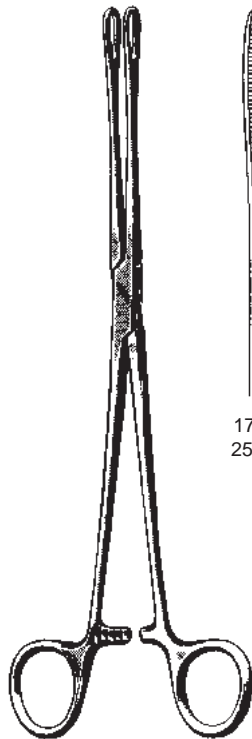

FOERSTER



17174-25  
 25 cm, 10"

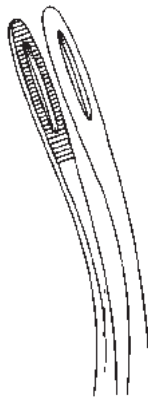

17175-25  
 25 cm, 10"



17180-18  
 18 cm, 7"



17180-25  
 25 cm, 10"

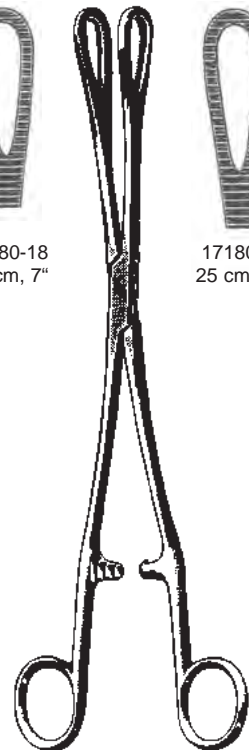

RAMPLEY

Tupferzangen  
 Dressing Forceps  
 Pinzas porta-esponjas  
 Pinze per tamponi



**BRYANT**  
 17207-13  
 13 cm, 5 1/8"



**LISTER (Sinus)**  
 17210-13 13 cm, 5 1/8"  
 17210-16 16 cm, 6 1/4"  
 17210-18 18 cm, 7"

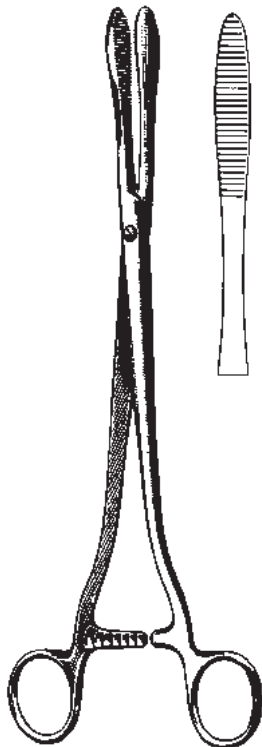

**COLLIN**  
 17220-25 25 cm, 10"



**PELKMANN**  
 17226-25 25 cm, 10"



**CHERON**  
 17229-25 25 cm, 10"

Tamponzangen  
 Dressing Forceps  
 Pinzas para tapones  
 Pinze per tamponi

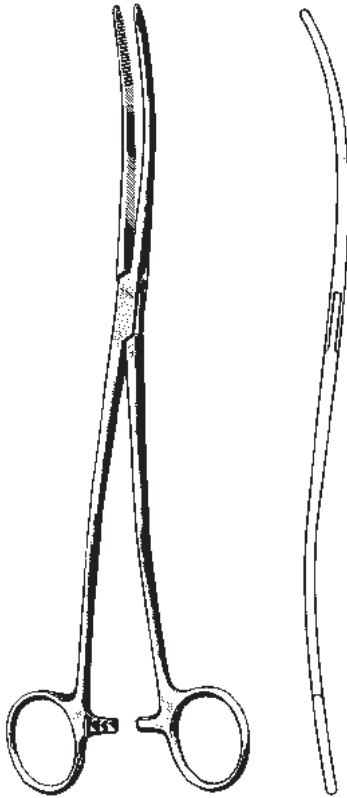

— BOZEMANN —  
 17230-26 17231-26  
 26 cm, 10 1/4"

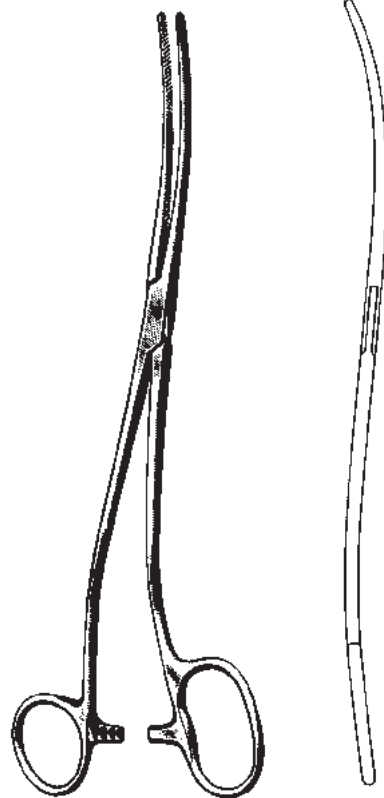

BOZEMANN-DOUGLAS  
 17233-26  
 26 cm, 10 1/4"

Wundhaken  
Retractors  
Separadores  
Divaricatori

\* Satz, set, juego, serie

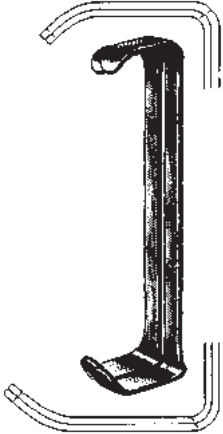

\* FARABEU  
19102-12  
12 cm, 4 3/4"

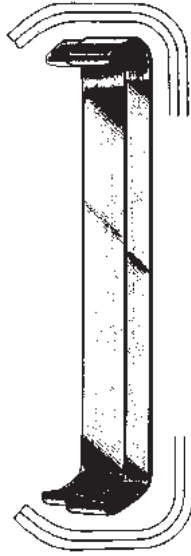

\* FARABEU  
19102-15  
15 cm, 6"



COLLIN  
19104-15  
15 cm, 6"

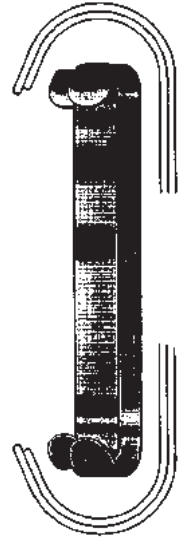

\* PARKER  
19110-13  
13,5 cm, 5 1/4"



\* PARKER  
19110-18 18 cm, 7"

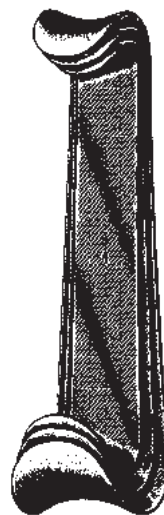

\* ROUX  
19120-00

Fig. 1 = 24x20 mm  
Fig. 2 = 29x26 mm  
Fig. 3 = 35x29 mm

Fig. 1 = 30x28 mm  
Fig. 2 = 36x36 mm  
Fig. 3 = 38x43 mm

19120-14 Fig. 1 14 cm, 5 1/2"  
19120-15 Fig. 2 15 cm, 6"  
19120-17 Fig. 3 17 cm, 6 3/4"



# MAST.SH-GERMANY

Wundhaken  
Retractors  
Separadores  
Divaricatori



**ROUX BABY**  
19122-13  
13 cm, 5 1/8"



**LUER**  
19123-11  
11 cm, 4 3/8"

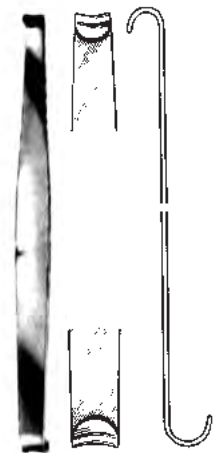

**ROUX mini**  
19124-15  
14 cm, 5 1/2"



**RAGNELL**  
19125-14  
14 cm, 5 1/2"



**ROSE**  
19126-13  
13 cm, 5 1/8"



**CRILE**  
19127-11  
11,5 cm, 4 1/2"

Wundhaken  
Retractors  
Separadores  
Divaricatori

Fig. 2 = 25x24 mm  
Fig. 1 = 21x24 mm

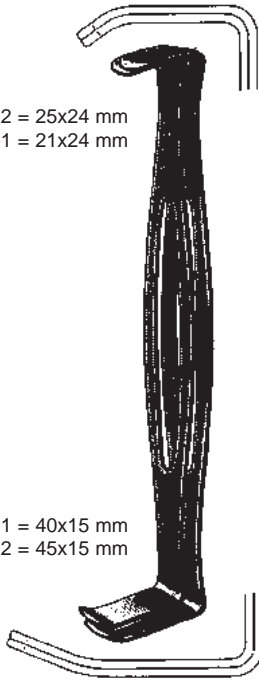

Fig. 1 = 40x15 mm  
Fig. 2 = 45x15 mm

\* US ARMY / Parker-Langenbeck  
19131-21 21 cm, 8 1/4"



MAYO-COLLINS  
19132-15  
15 cm, 6"

Fig. 2 = 47x13 mm  
Fig. 1 = 42x13 mm

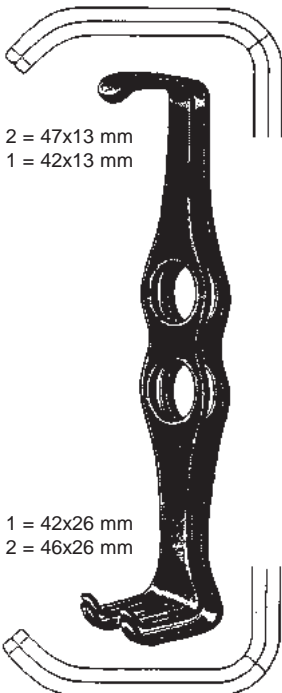

Fig. 1 = 42x26 mm  
Fig. 2 = 46x26 mm

\* MATHIEU  
19134-20 20 cm, 8"



37x40 mm

30 x 31 mm

GOELET  
19135-19 19 cm, 7 1/2"

52x33 mm



30x21 mm

COLLIN-HARTMANN  
19137-16 16 cm, 6 1/4"

Wundhaken  
Retractors  
Separadores  
Divaricatori



**RICHARDSON-EASTMAN**  
(Set) 19140-00  
(1) 19140-01 26 cm, 10 1/4"  
(2) 19140-02 28 cm, 11"

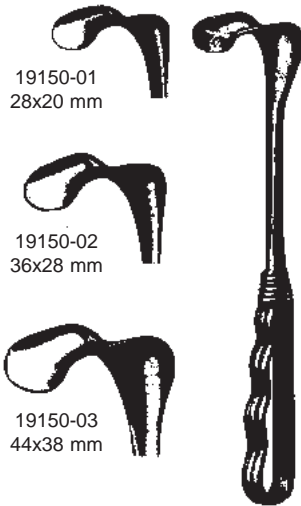

**RICHARDSON**  
24 cm, 9 1/2"



**RICHARDSON**  
19150-04  
24 cm, 9 1/2"

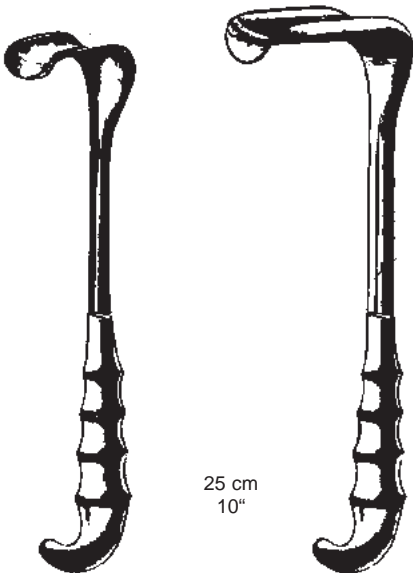

**RICHARDSON GRIP**  
19152-25 20x25 mm  
19152-31 25x31 mm  
19152-38 38x38 mm  
19152-51 19x51 mm  
19152-64 41x64 mm

**KELLY GRIP**  
19158-51 38x51 mm  
19158-64 51x64 mm  
19158-76 64x76 mm  
19158-82 70x82 mm



**KELLY**  
26 cm, 10 1/4"





Wundhaken, Bauch- und Darmspatel  
Retractors, abdominal and intestinal spatula  
Separadores, espátula intestinal y abdominal  
Divaricatori, spatole addominali e intestinali

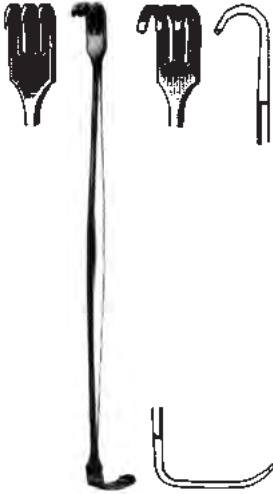

SENN-MILLER

19160-17    17 cm, 6 3/4"    19161-17

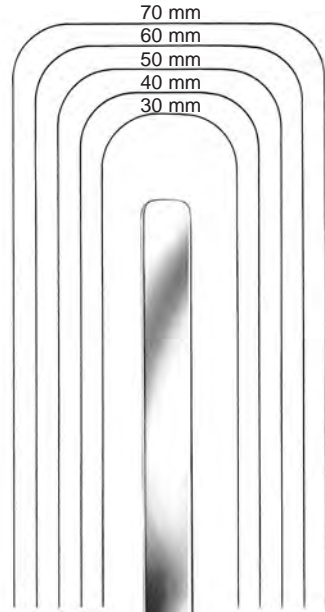

70 mm  
60 mm  
50 mm  
40 mm  
30 mm

biegsam, malleable, maleable, malleabili



RIBBON

19168-06 6x200 mm  
19168-08 8x200 mm  
19168-10 10x200 mm  
19168-12 12x200 mm  
19168-17 17x200 mm  
19168-20 20x200 mm  
19168-25 25x200 mm  
19169-25 25x250 mm



RIBBON

19170-20 20x330 mm  
19170-25 25x330 mm  
19170-32 32x330 mm  
19170-40 40x330 mm  
19170-45 45x330 mm  
19170-50 50x330 mm  
19170-65 65x330 mm  
19170-76 76x330 mm



biegsam  
malleable  
maleable  
malleabili

41 cm, 16"

19171-30 30 mm  
19171-40 40 mm  
19171-50 50 mm  
19171-60 60 mm  
19171-70 70 mm



# MAST.SH-GERMANY

Bauch- und Darmspatel  
 Abdominal and intestinal spatulas  
 Separadores, espátula intestinal y abdominal  
 Divaricatori, spatole addominali e intestinali

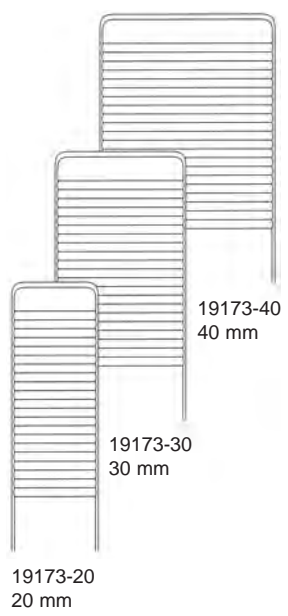

HABERER  
 19174-17 17/25x200 mm  
 19174-25 25/30x280 mm  
 19174-37 37/45x300 mm  
 19174-40 40/50x300 mm



REVERDIN  
 19175-28  
 28 cm, 11"



**MAST.SH-GERMANY**

Bauch- und Darmspatel  
Abdominal and intestinal spatula  
Separadores, espátula intestinal y abdominal  
Divaricatori, spatole addominali e intestinali

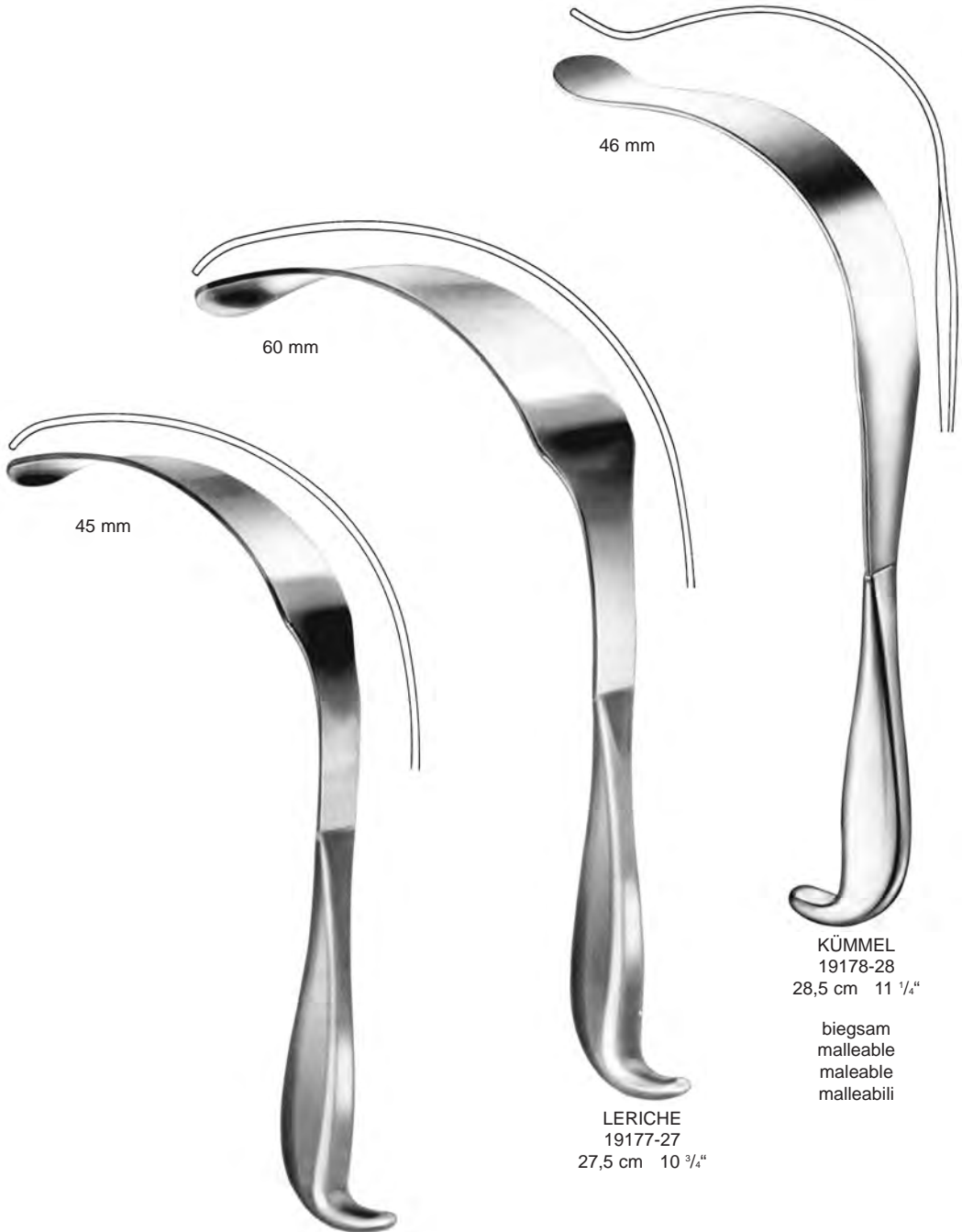

45 mm

60 mm

46 mm

LERICHE  
19177-27  
27,5 cm 10 <sup>3</sup>/<sub>4</sub>"

KÜMMEL  
19178-28  
28,5 cm 11 <sup>1</sup>/<sub>4</sub>"

biegsam  
malleable  
maleable  
malleabili

LERICHE  
19176-25  
25 cm 10"

Bauchspatel  
Abdominal Spatulas  
Espátula abdominal  
Spatola addominale



KÜMMEL  
19179-28  
31 cm 12 1/4"

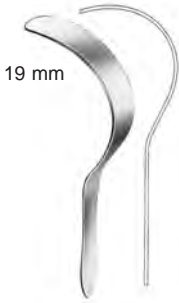

DEAVER  
19180-19  
19 cm, 7 1/2"



DEAVER  
19181-22  
21,5 cm, 8 1/2"



DEAVER  
19181-25  
23 cm, 9"



DEAVER  
19183-25  
30 cm, 11 3/4"



DEAVER  
19185-25  
33 cm, 13"



DEAVER  
19187-25  
36 cm, 14"



# MAST.SH-GERMANY

Wundhaken  
Retractors  
Separadores  
Divaricatori



38 mm

DEAVER  
19187-38 38x300 mm  
30 cm, 11 3/4"



50 mm

DEAVER  
19187-50 50x300 mm  
31 cm 12 1/4"



75 mm

DEAVER  
19187-75 75x300 mm  
32 cm, 12 3/4"



DEAVER GRIP  
19189-25 25x310 mm  
19189-38 38x310 mm  
19189-50 50x310 mm  
19189-75 75x310 mm  
31 cm 12 1/4"



Wundhaken  
Retractors  
Separadores  
Divaricatori

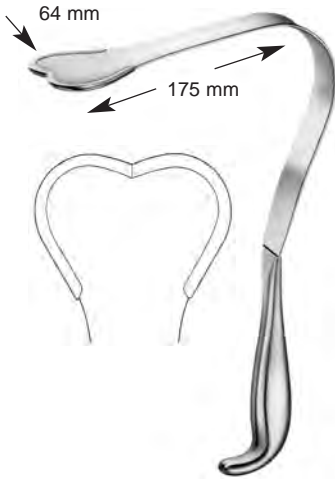

HARRINGTON-PEMBERTON  
19190-64  
29,5 cm 11 3/4"



HARRINGTON  
19191-25 25x230 mm  
19191-40 40x320 mm  
19191-62 62x320 mm



64x60 mm

TUFFIER  
19192-23



# MAST.SH-GERMANY

Wundhaken  
Retractors  
Separadores  
Divaricatori

rechts  
right  
a la derecha  
a destra  
(45 mm x 48 mm)



COOLEY  
19195-01  
21,5 cm, 8 1/2"

rechts, gerieft  
right serrated  
a la derecha, estriado  
a destra, zigrinato  
(45 mm x 48 mm)



COOLEY  
19195-02  
21,5 cm, 8 1/2"

links  
left  
a la izquierda  
a sinistra  
(24 mm x 48 mm)



COOLEY  
19195-03  
23 cm, 9"





Hauthäkchen  
Nerve and wound hooks  
Ganchos y ganchitos para nervios  
Uncini per nervi e divaricatori fini



GRAEFE  
19210-12  
scharf  
sharp  
agudo  
acuto



GRAEFE  
19211-12  
stumpf  
blunt  
romo  
smusso



12 cm, 4 3/4"



GUTHRIE  
19212-01



GUTHRIE  
19212-02



scharf  
sharp  
agudo  
acuto  
A  
stumpf  
blunt  
romo  
smusso  
B

FRAZIER

- A 19214-13 13 cm, 5"
- A 19214-18 18 cm, 7"
- B 19215-13 13 cm, 5"
- B 19215-18 18 cm, 7"



LAHEY  
12 cm, 4 3/4"



19215-01



19215-02



19215-03



JOSEPH  
16 cm, 6 1/4"



19216-01



19216-02  
2 mm



19216-05  
5 mm



19216-07  
7 mm



19216-10  
10 mm



KLEINERT-KUTZ  
13 cm, 5 1/8"



19217-03



19217-05



19217-07



# MAST.SH-GERMANY

Hauthäkchen  
Nerve and wound hooks  
Ganchos y ganchitos para nervios  
Uncini per nervi e divaricatori fini

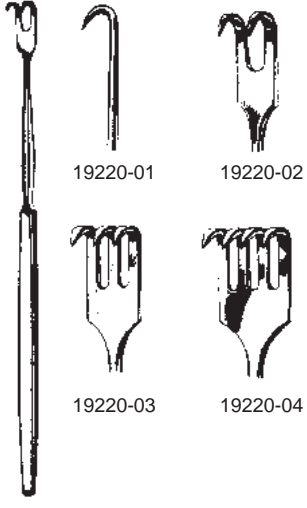

19220-01

19220-02

19220-03

19220-04

Reda  
16 cm, 6 1/4"

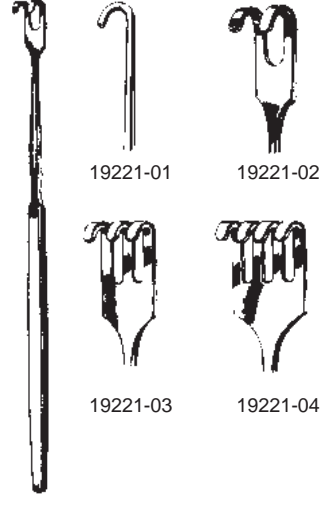

19221-01

19221-02

19221-03

19221-04

Reda  
16 cm, 6 1/4"

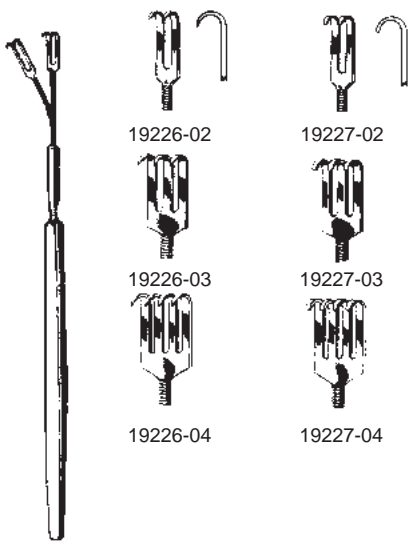

19226-02

19227-02

19226-03

19227-03

19226-04

19227-04

Reda, flexibel  
16 cm, 6 1/4"



19229-02

19229-03

KLAPP  
17,5 cm, 6.9"

Wundhaken  
Retractors  
Separadores  
Divaricatori

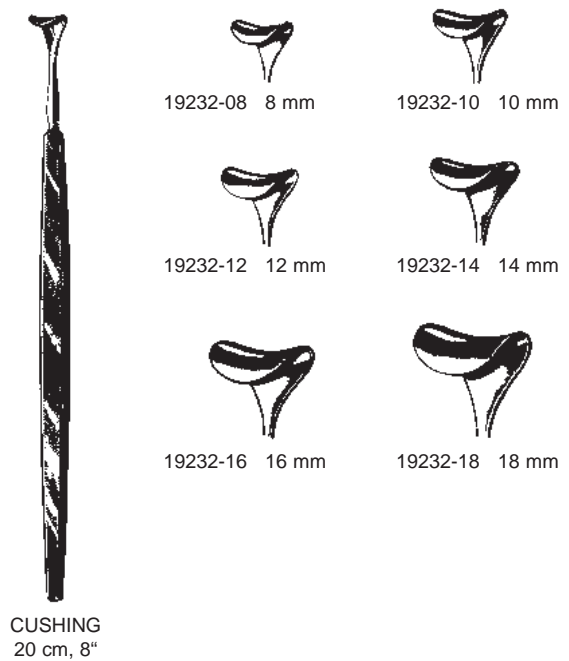
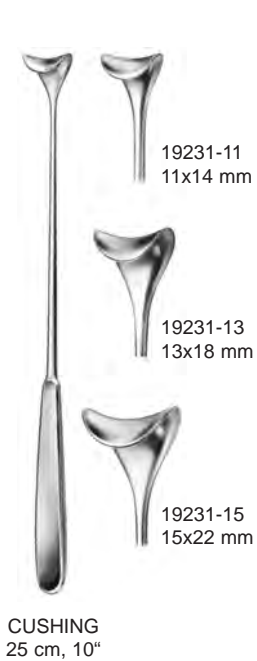
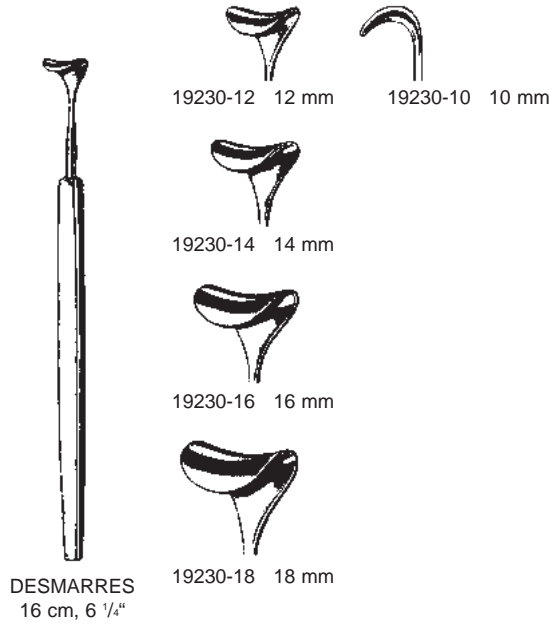



# MAST.SH-GERMANY

Wundhaken  
Retractors  
Separadores  
Divaricatori



CUSHING  
24 cm, 9 1/2"

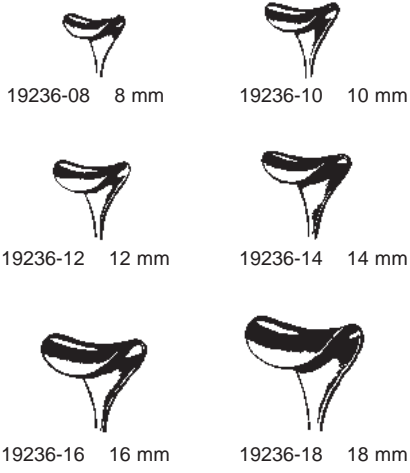

GIL-VERNET  
19233-08 - 19233-23  
24 cm, 9 1/2"

biegsam  
malleable  
maleable  
malleabile

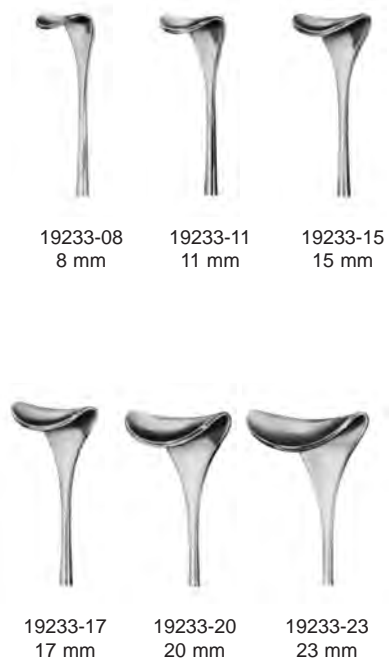

Wundhaken  
Retractors  
Separadores  
Divaricatori



**CUSHING**  
19234-20  
20 cm, 8"



**CUSHING**  
19235-21  
21,5 cm, 8 1/2"



**KÖNIG**  
18 cm, 7"



19236-01  
13x13 mm



19236-02  
12x16 mm



**SENN-GREEN**  
15 cm, 6"



19240-10 10x6 mm



19240-20 20x6 mm



**LANGENBECK-GREEN**  
16 cm, 6 1/4"



19250-16  
16x6 mm



19250-24  
24x6 mm



**VOLKMANN**  
11,5 cm, 4 1/2"



19270-02



19270-03



19270-04



19270-06



19271-02



19271-03



19271-04



19271-06



# MAST.SH-GERMANY

Wundhaken  
Retractors  
Separadores  
Divaricatori



19280-01



19280-02



19280-03



19280-04



19280-06



scharf  
sharp  
agudo  
acuto



19281-01



19281-02



19281-03



19281-04



19281-06

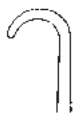

stumpf  
blunt  
romo  
smusso



19282-02



19282-03



19282-04



19282-06



halbscharf  
semi-sharp  
medio romo  
mezzo smusso



VOLKMANN  
21,5 cm, 8 1/2"



**MAST.SH-GERMANY**

Wundhaken  
Retractors  
Separadores  
Divaricatori



19296-01



19296-02



19296-03



19296-04



19296-06



19296-08



19297-01



19297-02



19297-03



19297-04



19297-06



19297-08



KOCHER  
19296-01 - 19297-08  
22 cm, 8 <sup>3</sup>/<sub>4</sub>"



# MAST.SH-GERMANY

Wundhaken, Knochenhaken  
 Retractors, Bone Retractors  
 Separadores, Separadores oseos  
 Divaricatori, Divaricatori per ossa



VOLKMANN  
19298-01  
22 cm 8 3/4"

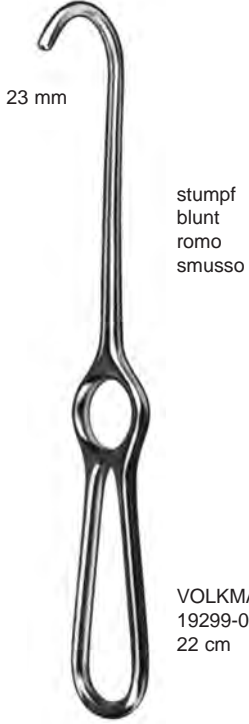

VOLKMANN  
19299-01  
22 cm 8 3/4"

Zähne  
teeth  
dientes  
denti

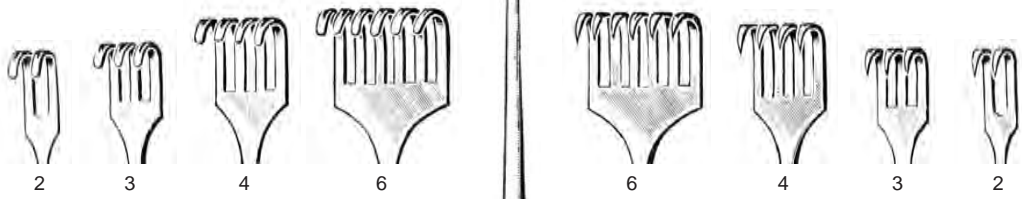

stumpf  
blunt  
romo  
smusso

- 19301-02 8x 8 mm
- 19301-03 8x13 mm
- 19301-04 8x18 mm
- 19301-06 8x28 mm

scharf  
sharp  
agudo  
acuto

- 19300-02 8x 8 mm
- 19300-03 8x13 mm
- 19300-04 8x18 mm
- 19300-06 8x28 mm





Wundhaken  
Retractors  
Separadores  
Divaricatori



**MEYERDING**  
18 cm, 7"



19302-01 18x7 mm



19302-04 7x4 mm



19302-02 16x5 mm



19302-05 10x3 mm



19302-03 7x4 mm



19302-06 10x4 mm

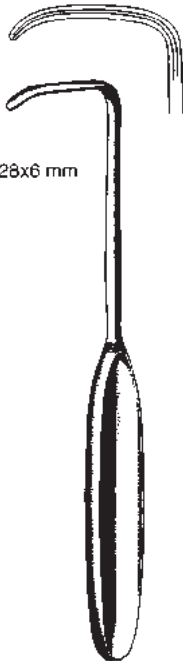

28x6 mm

**LAHEY**  
19304-19  
19 cm, 7 1/2"

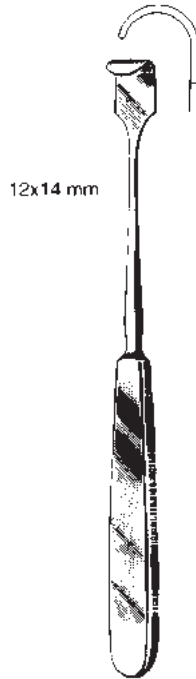

12x14 mm

**LITTLE**  
19306-20  
20 cm, 8"



**STRANDELL-STILLE**  
17 cm 6 3/4"

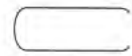

19307-01



19307-02

Wundhaken  
 Retractors  
 Separadores  
 Divaricatori

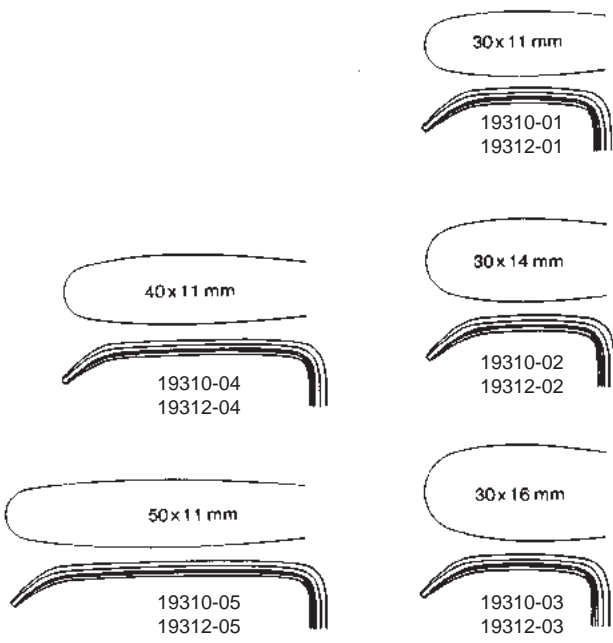

LANGENBECK  
 19310-01 - 19310-05  
 22 cm, 8 3/4"



LANGENBECK  
 19312-01 - 19312-05  
 21 cm, 8 1/4"



Wundhaken  
Retractors  
Separadores  
Divaricatori

- 19314-07 35x 7 mm
- 19314-10 35x10 mm
- 19314-12 80x12 mm
- 19314-14 70x14 mm
- 19314-15 35x15 mm
- 19314-16 80x16 mm
- 19314-20 60x20 mm
- 19315-06 25x 6 mm
- 19330-40 40x12 mm
- 19330-55 55x11 mm

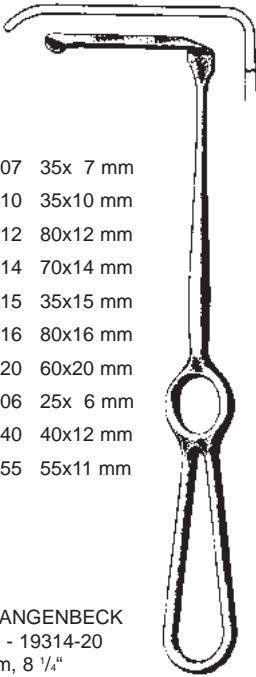

**KOCHER-LANGENBECK**  
19314-07 - 19314-20  
21 cm, 8 1/4"

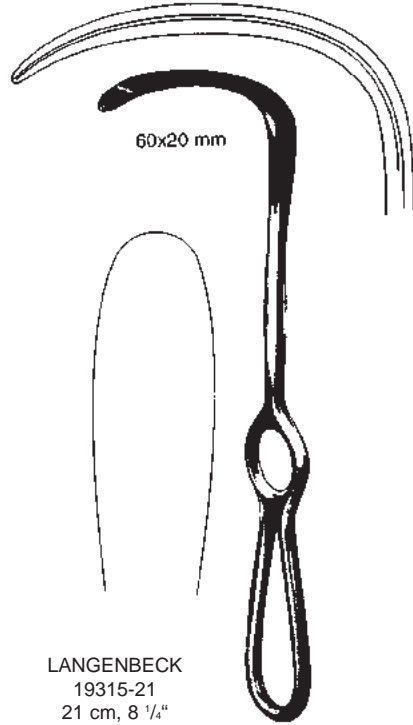

**LANGENBECK**  
19315-21  
21 cm, 8 1/4"



**LANGENBECK**  
19317-21  
21 cm, 8 1/4"

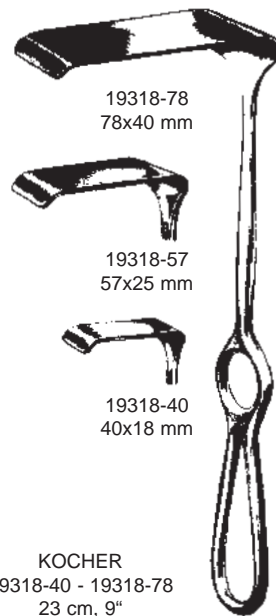

**KOCHER**  
19318-40 - 19318-78  
23 cm, 9"

Wundhaken  
Retractors  
Separadores  
Divaricatori



19344-14  
14x17 mm  
21,5 cm, 8 1/2"



19344-20  
20x22 mm  
22 cm, 8 3/4"



19344-26  
26x30 mm  
23,5 cm, 9 1/4"



**MIDDLELDORF**  
19344-14 - 19344-26



**KOCHER**  
19340-10 40x10 mm  
19340-15 40x15 mm  
19340-20 40x20 mm  
22 cm, 8 3/4"

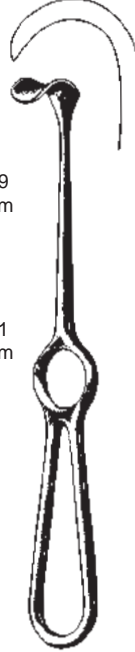

19332-19  
19x12 mm  
19332-21  
21x14 mm  
**KOCHER**  
19332-19 - 19332-21  
19 cm, 7 1/2"



**MIDDLELDORF**  
19345-01 45x45 mm  
25,5 cm, 10"



19345-02  
45x50 mm



19345-03  
55x70 mm



**GREEN**  
19348-22  
22 cm, 8 3/4"



**MAST.SH-GERMANY**

Wundhaken  
Retractors  
Separadores  
Divaricatori



35 x 8 mm

ZENKER  
19350-35  
25 cm, 10"



60 x 12 mm

ZENKER  
19350-60  
26 cm, 10 1/4"



75 x 12 mm

ZENKER  
19350-70  
27,5 cm, 10.8"



Wundhaken  
Retractors  
Separadores  
Divaricatori

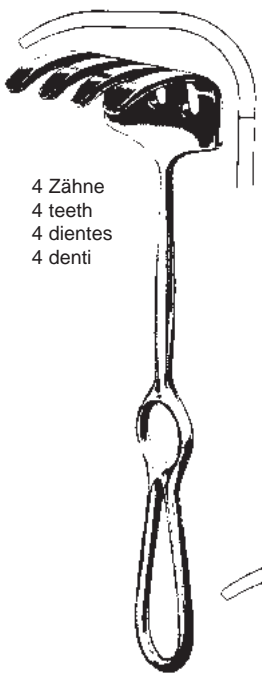

4 Zähne  
4 teeth  
4 dientes  
4 denti

ISRAEL  
19364-40 40X40 mm  
25 cm, 10"

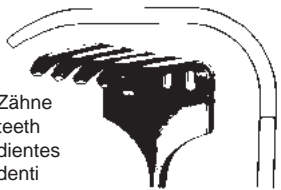

5 Zähne  
5 teeth  
5 dientes  
5 denti

19364-50 45x50 mm

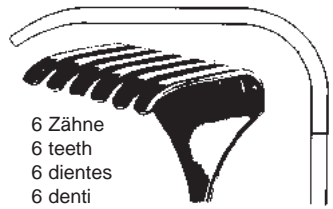

6 Zähne  
6 teeth  
6 dientes  
6 denti

19364-60 50x60 mm

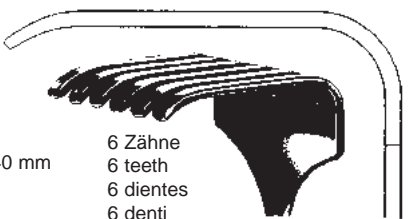

6 Zähne  
6 teeth  
6 dientes  
6 denti

19364-70 70x70 mm

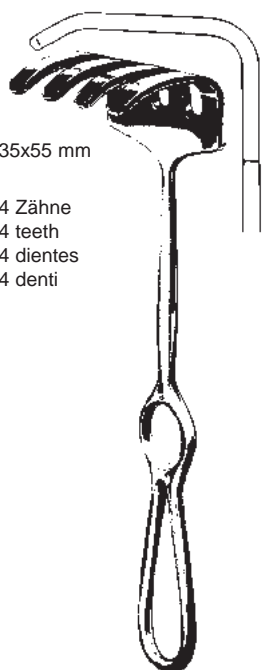

35x55 mm

4 Zähne  
4 teeth  
4 dientes  
4 denti

OLLIER  
19360-04 22,5 cm, 8.9"

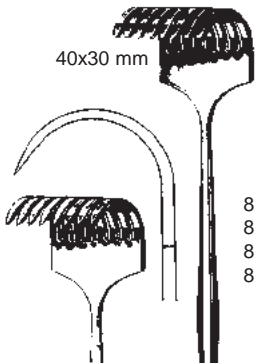

40x30 mm

8 Zähne  
8 teeth  
8 dientes  
8 denti

spitz  
sharp  
agudo  
acuto

stumpf  
blunt  
romo  
smusso

KOERTE  
19366-08 23,5 cm, 9 1/4" 19367-08

Wundhaken  
Retractors  
Separadores  
Divaricatori



**FRITSCH**  
19370-40 45x40 mm  
19370-50 45x50 mm  
19370-60 45x60 mm  
19370-75 45x75 mm  
19370-85 65x85 mm  
24 cm, 9 1/2"



**KOCHER**  
19372-22  
70x25 mm  
22,5 cm, 8.9"



**KOCHER**  
19374-45 80x45 mm  
19374-55 80x55 mm  
19374-65 80x65 mm  
25 cm, 10"



**DOYEN**  
19378-25  
25 cm, 10"

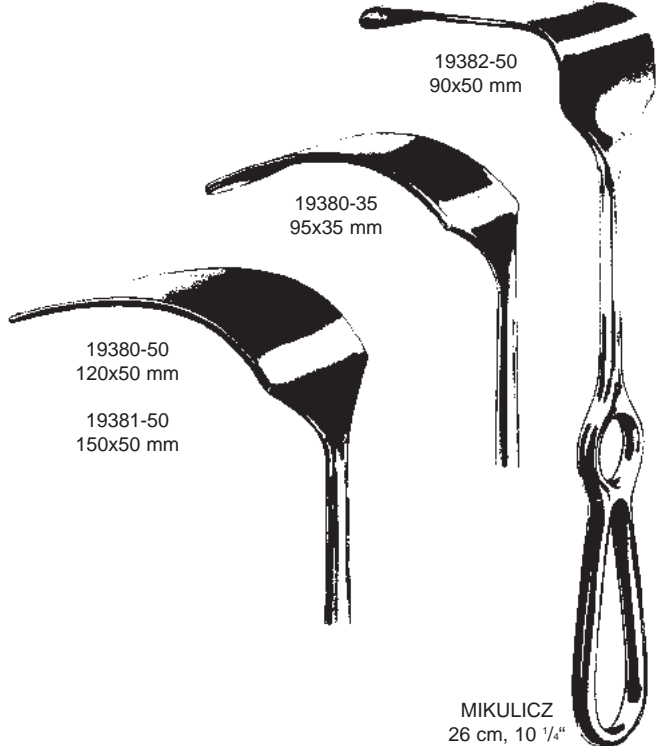

**MIKULICZ**  
26 cm, 10 1/4"



# MAST.SH-GERMANY

Wundhaken  
Retractors  
Separadores  
Divaricatori



19388-40 70x40 mm  
19388-50 70x50 mm  
19388-65 70x65 mm



**MORRIS**  
24,5 cm  
9 3/4"

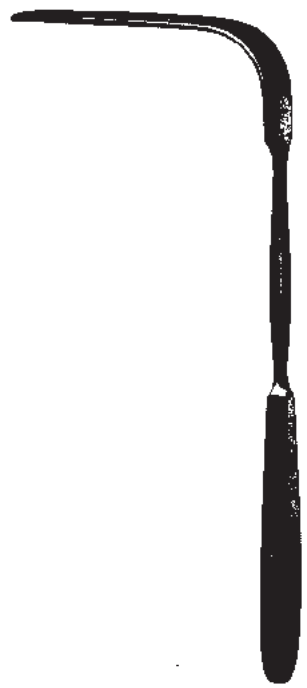

**SIMON**  
19480-22 115x22 mm  
19480-27 115x27 mm  
28 cm, 11"

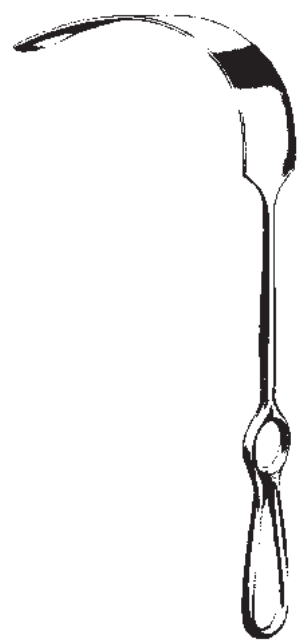

**KELLY**  
19385-38 160x38 mm  
19385-57 160x57 mm  
27 cm, 10 1/2"



19482-82  
82x28 mm



19482-73  
73x28 mm



19482-45  
45x25 mm

**HEANEY**  
19482-45 - 19482-82  
27 cm, 10 1/2"

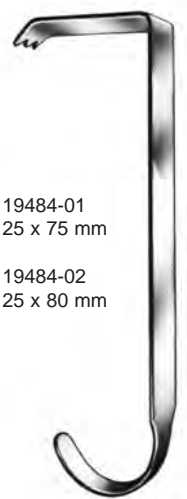

19484-01  
25 x 75 mm  
19484-02  
25 x 80 mm

**HIBBS**  
24 cm, 9 1/2"



125x37 mm

**SAUERBRUCH**  
19492-25  
25 cm, 10"





**MAST.SH-GERMANY**

Wundhaken  
Retractors  
Separadores  
Divaricatori

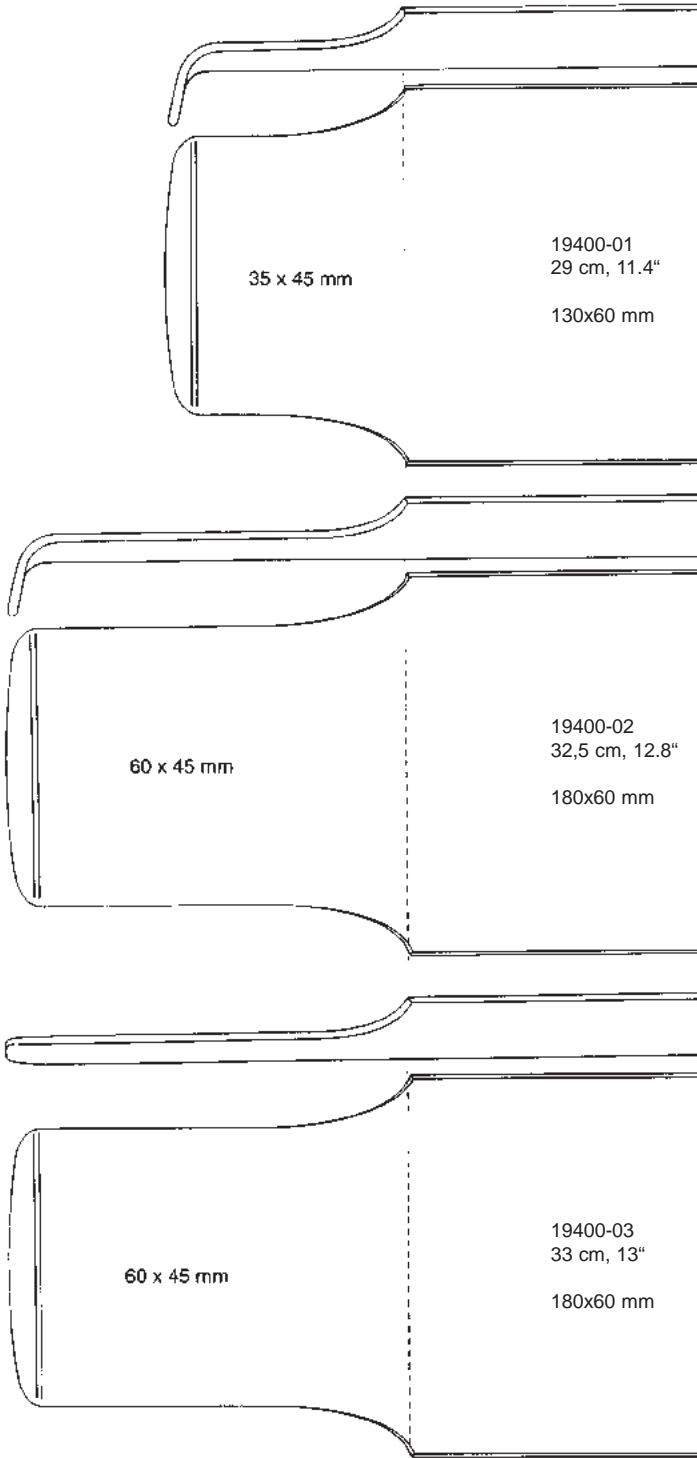

Pelvis-Haken  
Pelvis retractor  
Retractor de pelvis  
Divaricatori pelvici



ST. MARKS  
19400-01 19400-03

Wundhaken  
 Retractors  
 Separadores  
 Divaricatori

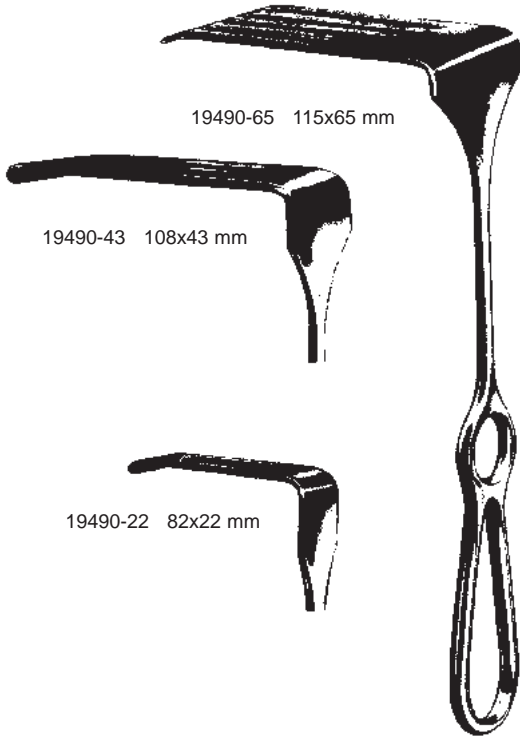

19490-65 115x65 mm

19490-43 108x43 mm

19490-22 82x22 mm

CORYLLOS (Thorax)  
 19490-22 - 19490-65  
 24 cm, 9 1/2"

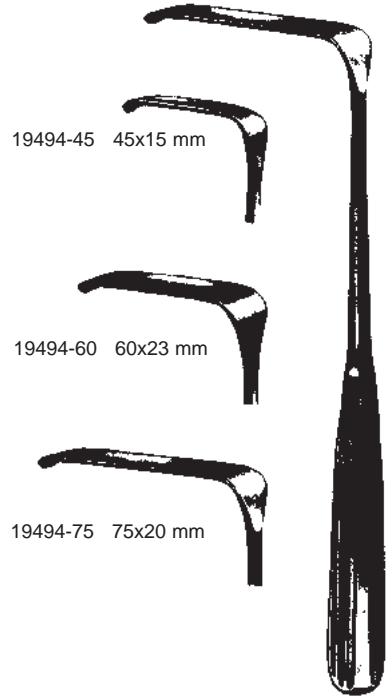

19494-45 45x15 mm

19494-60 60x23 mm

19494-75 75x20 mm

SAUERBRUCH  
 19494-45 - 19494-75  
 22,5 cm, 8.9"



DAVIDSON (Scapula)  
 19496-50 75x50 mm



DAVIDSON (Scapula)  
 19496-90 75x90 mm

Wundhaken  
Retractors  
Separadores  
Divaricatori

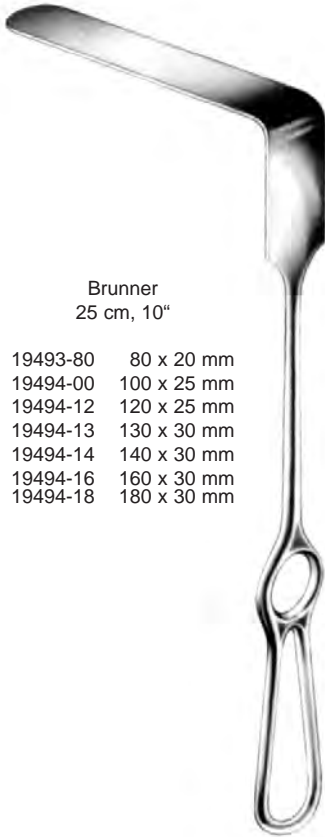

Brunner  
25 cm, 10"

19493-80	80 x 20 mm
19494-00	100 x 25 mm
19494-12	120 x 25 mm
19494-13	130 x 30 mm
19494-14	140 x 30 mm
19494-16	160 x 30 mm
19494-18	180 x 30 mm

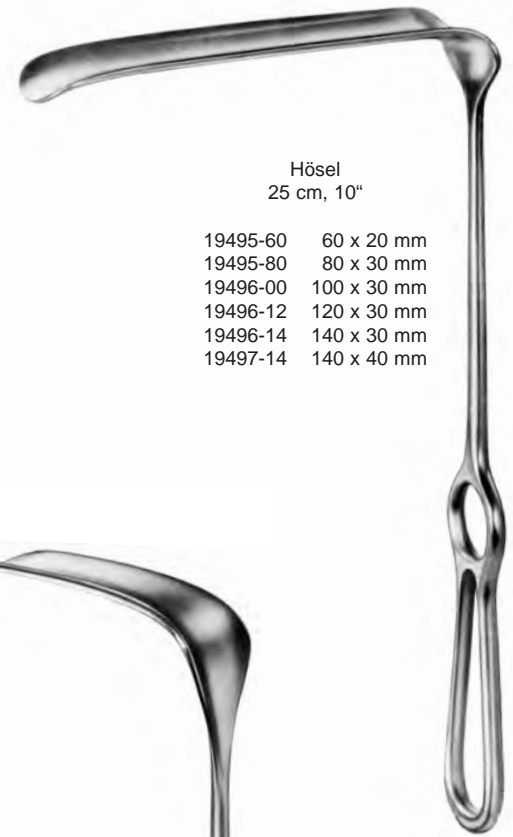

Hösel  
25 cm, 10"

19495-60	60 x 20 mm
19495-80	80 x 30 mm
19496-00	100 x 30 mm
19496-12	120 x 30 mm
19496-14	140 x 30 mm
19497-14	140 x 40 mm



Doyen-Stillé  
25 cm, 10"

19498-01	97 x 29 mm
19498-02	101 x 31 mm
19498-03	127 x 52 mm



Wundsperrer  
Retractors  
Separadores  
Divaricatori

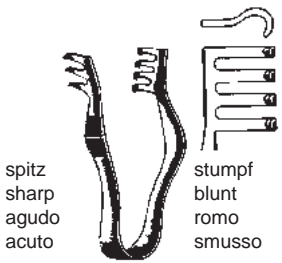

spitz  
sharp  
agudo  
acuto

stumpf  
blunt  
romo  
smusso

FINSEN  
19610-07 7 cm, 2 3/4" 19611-07

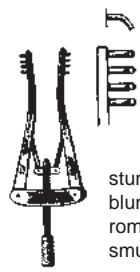

spitz  
sharp  
agudo  
acuto

stumpf  
blunt  
romo  
smusso

ALM  
19620-07 7 cm, 2 3/4" 19621-07  
19620-10 10 cm, 4" 19621-10



JANSSEN  
19630-10  
10 cm, 4"



JANSSEN  
19631-10  
10 cm, 4"



spitz  
sharp  
agudo  
acuto

stumpf  
blunt  
romo  
smusso

HOLZHEIMER  
19634-10 19635-10  
10 cm, 4"



PERKINS  
19636-14  
13 cm, 5 1/8"



PERKINS  
19637-14  
13 cm, 5 1/8"



Wundsperrer  
Retractors  
Separadores  
Divaricatori

3x4 Zähne



spitz  
sharp  
agudo  
acuto

stumpf  
blunt  
romo  
smusso



SCALP-CONTOUR  
19640-14 - 19641-14  
13,5 cm, 5 1/4"

2x3 Zähne

spitz  
sharp  
agudo  
acuto

stumpf  
blunt  
romo  
smusso

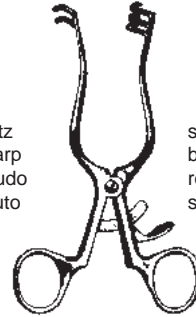

WEITLANER  
19650-10 19651-10  
11,5 cm, 4 1/2"

3x3 Zähne

spitz  
sharp  
agudo  
acuto

stumpf  
blunt  
romo  
smusso

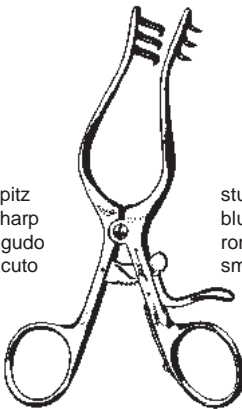

WEITLANER-WULLSTEIN  
19654-13 19655-13  
13 cm, 5 1/8"

3x4 Zähne

spitz  
sharp  
agudo  
acuto

stumpf  
blunt  
romo  
smusso

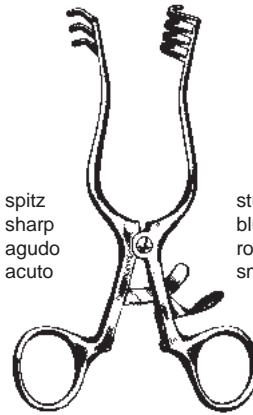

WEITLANER  
19670-14 14,0 cm, 5 1/2" 19671-14  
19670-16 16,5 cm, 6 1/2" 19671-16  
19670-20 20,0 cm, 8" 19671-20  
19670-24 24,0 cm, 9 1/2" 19671-24

Wundsperrer  
Retractors  
Separadores  
Divaricatori

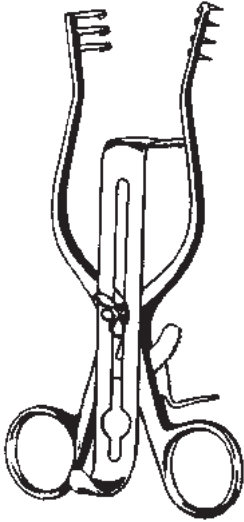

HENLEY  
19675-00 - 19677-32  
16,5 cm, 6 1/2"



19675-00 komplett, stumpf, 3x4 Z. und 3 Valven  
19675-00 complete, blunt, 3x4 teeth and 3 blades  
19675-00 completo, romo, 3x4 dientes y 3 valvas  
19675-00 completo, smusso, 3x4 d. e 3 valve

19676-00 komplett, scharf, 3x4 Z. und 3 Valven  
19676-00 complete, sharp, 3x4 teeth and 3 blades  
19676-00 complete, agudo, 3x4 dientes y 3 valvas  
19676-00 completo con retr. acuto 3x4 d. e 3 valve

19678-05 Retraktor allein, stumpf 3x4 Zähne  
19678-05 Retractor only, blunt 3x4 teeth  
19678-05 Separador solo, romo, 3x4 dientes  
19678-05 Retrattore solo, smusso 3x4 denti

19678-06 Retraktor allein, spitz 3x4 Zähne  
19678-06 Retractor only, sharp 3x4 teeth  
19678-06 Separador solo, agudo, 3x4 dientes  
19678-06 Retrattore solo, acuto 3x4 denti



19677-19  
16x19 mm  
5/8" x 3/4"

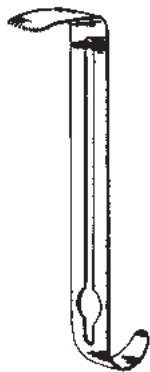

19677-25  
16x25 mm  
5/8" x 1"

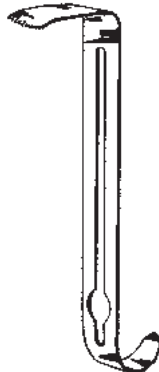

19677-32  
16x32 mm  
5/8" x 1 1/4"

Wundsperrer  
Retractors  
Separadores  
Divaricatori



**PLESTER**  
19672-11 11 cm, 4 <sup>3</sup>/<sub>8</sub>"  
stumpf - blunt - romo - smusso

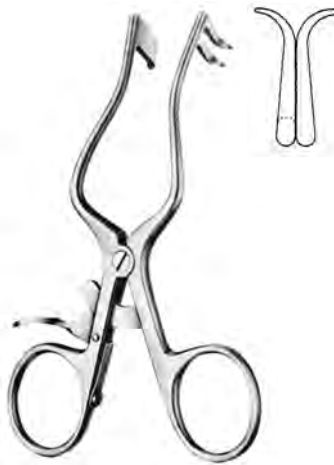

**PLESTER**  
19673-11 11 cm, 4 <sup>3</sup>/<sub>8</sub>"  
stumpf - blunt - romo - smusso

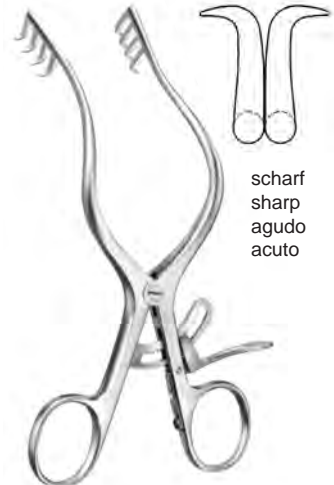

**MOLLISON**  
19674-15 15 cm, 6"

scharf  
sharp  
agudo  
acuto



**WULLSTEIN**  
19675-13  
13 cm, 5 <sup>1</sup>/<sub>8</sub>"



**PLESTER**  
19677-13  
13 cm, 5 <sup>1</sup>/<sub>8</sub>"

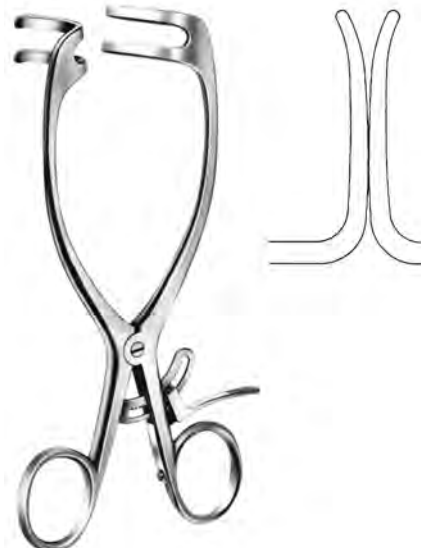

**MAYO-ADAMS**  
19678-16  
16,5 cm, 6 <sup>1</sup>/<sub>2</sub>"

Wundsperrer  
 Retractors  
 Separadores  
 Divaricatori

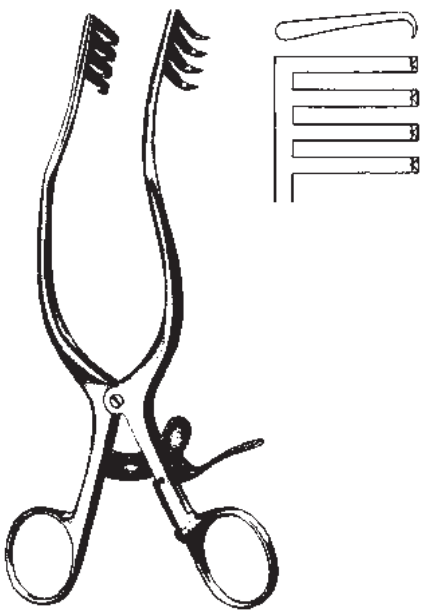

ANDERSON ADSON  
 19679-20 19,5 cm, 7 3/4"



NORFOLK / NORWICH  
 19679-22 22 cm, 8 3/4"



spitz  
 sharp  
 agudo  
 acuto

ADSON  
 19680-19 19 cm, 7 1/2" 19681-19

stumpf  
 blunt  
 romo  
 smusso



TRAVERS  
 19681-21 21,5 cm, 8 1/2"





Wundsperrer  
Retractors  
Separadores  
Divaricatori

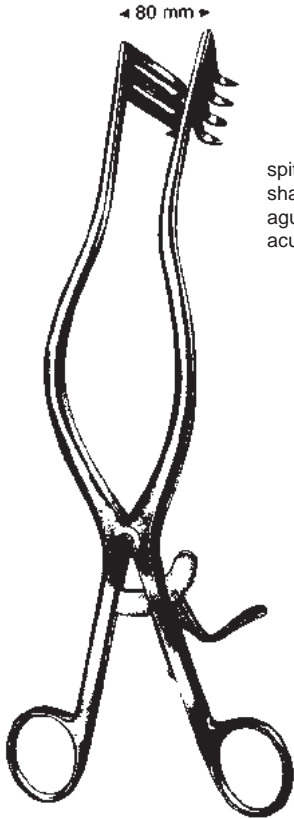

spitz  
sharp  
agudo  
acuto

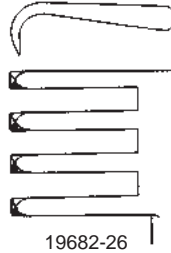

19682-26

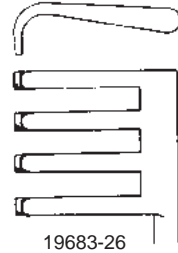

stumpf  
blunt  
romo  
smusso

19683-26

ADSON  
19682-26 - 19683-26  
26,5 cm, 10 1/2"

- 19684-14 14 cm, 5 1/2"
- 19684-16 16 cm, 6 1/4"
- 19684-20 20 cm, 8"
- 19684-26 26 cm, 10 1/4"

spitz  
sharp  
agudo  
acuto

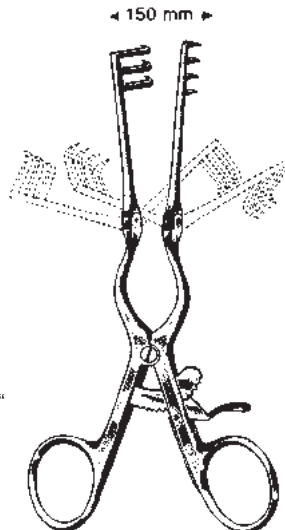

- 19685-14 14 cm, 5 1/2"
- 19685-16 16 cm, 6 1/4"
- 19685-20 20 cm, 8"
- 19685-26 26 cm, 10 1/4"

stumpf  
blunt  
romo  
smusso

ADSON

Wundsperrer  
Retractors  
Separadores  
Divaricatori

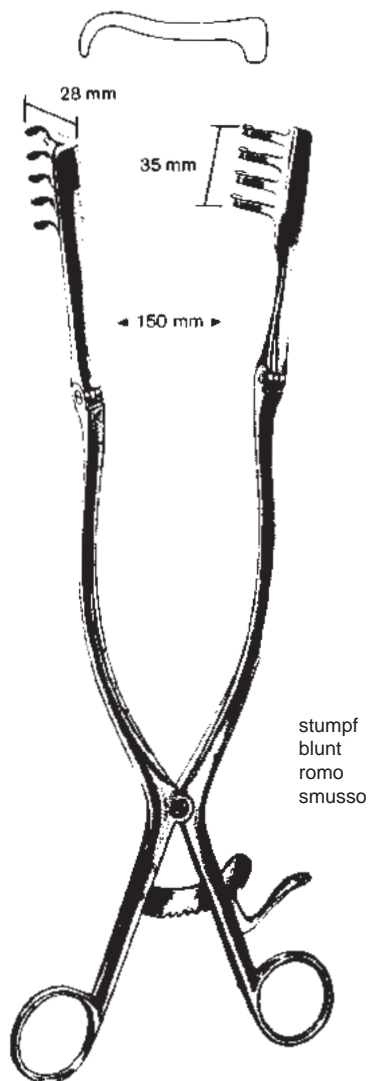

ADSON  
19686-32  
32 cm, 12 3/4"

Wundsperrer  
Retractors  
Separadores  
Divaricatori



Beckman-Adson  
31 cm, 12 1/4"

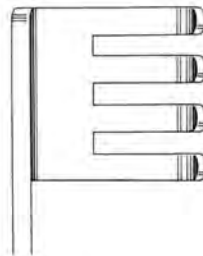

19687-01  
25 x 27 mm

stumpf  
blunt  
romo  
smusso

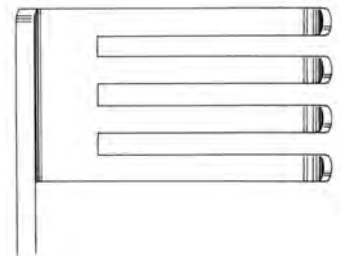

19688-01  
45 x 27 mm

stumpf  
blunt  
romo  
smusso

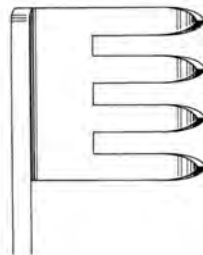

19687-02  
25 x 27 mm

scharf  
sharp  
agudo  
acuto

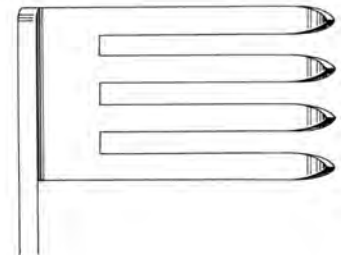

19688-02  
45 x 27 mm

scharf  
sharp  
agudo  
acuto

Wundsperrer  
 Retractors  
 Separadores  
 Divaricatori



MARTIN  
 28,5 cm, 11 1/4"

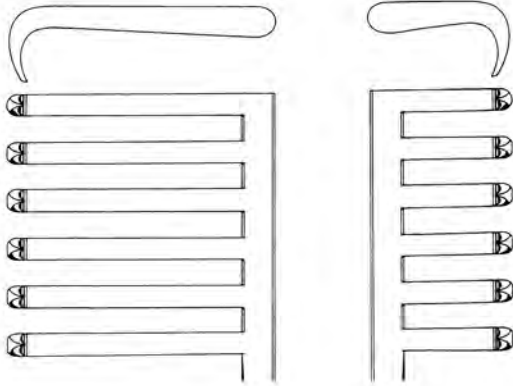

19689-01  
 6x6 Zähne

scharf, lange Zähne links  
 sharp, long teeth on left side  
 agudo, dientes largos a la izquierda  
 acuto, denti lunghe a sinistra

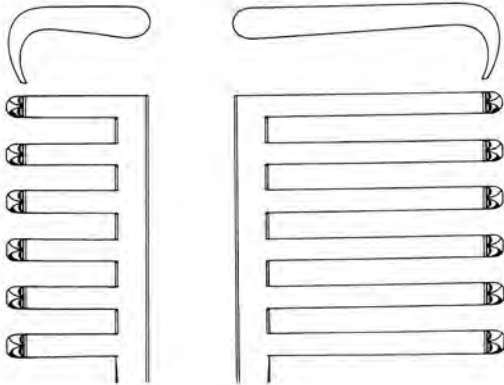

19689-02  
 6x6 Zähne

scharf, lange Zähne rechts  
 sharp, long teeth on right side  
 agudo, dientes largos a la derecha  
 acuto, denti lunghe a destra

Wundsperrer  
 Retractors  
 Separadores  
 Divaricatori

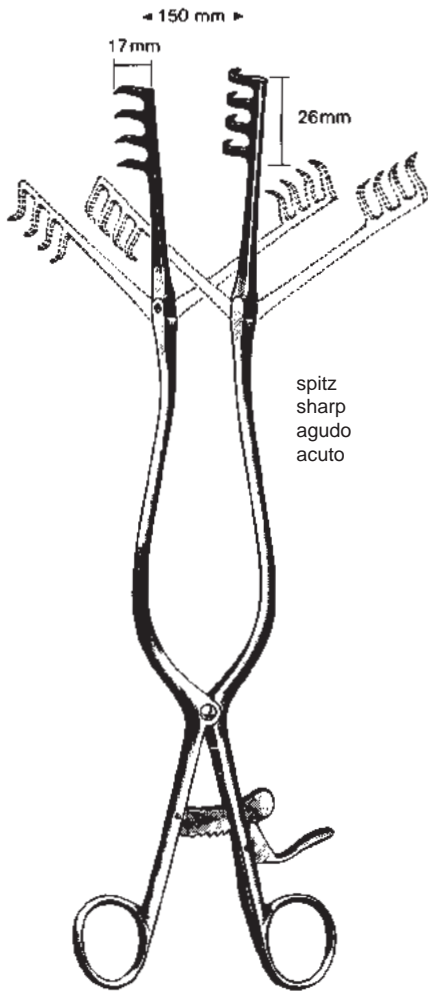

spitz  
 sharp  
 agudo  
 acuto

BECKMANN  
 19690-31  
 31 cm, 12 1/4"

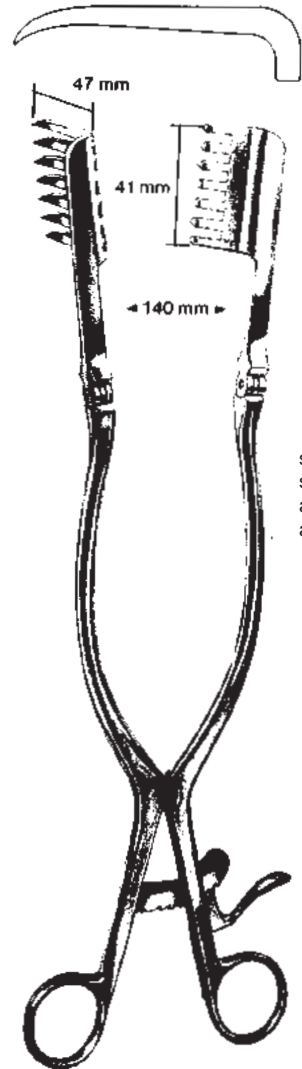

spitz  
 sharp  
 agudo  
 acuto

BECKMANN-EATON  
 19692-32  
 32 cm, 12 3/8"

Wundhaken  
Retractors  
Separadores  
Divaricatori

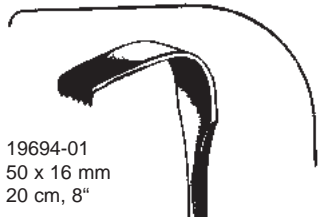

19694-01  
50 x 16 mm  
20 cm, 8"

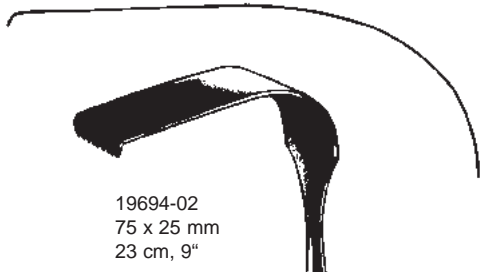

19694-02  
75 x 25 mm  
23 cm, 9"

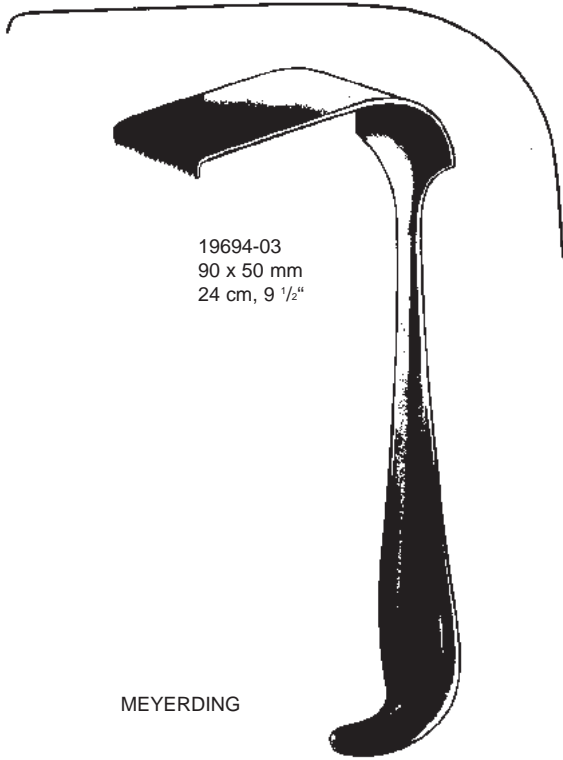

19694-03  
90 x 50 mm  
24 cm, 9 1/2"

MEYERDING

Wundsperrer  
Retractors  
Separadores  
Divaricatori

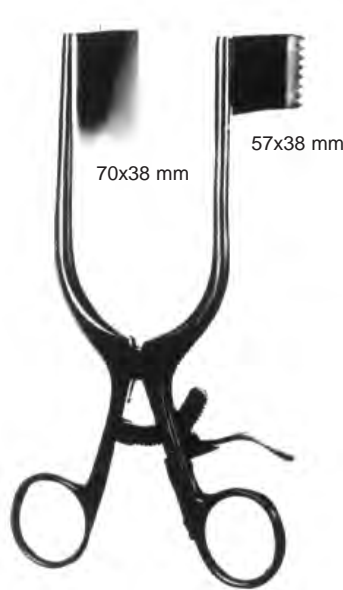

DARLING  
19696-18 18 cm, 7"

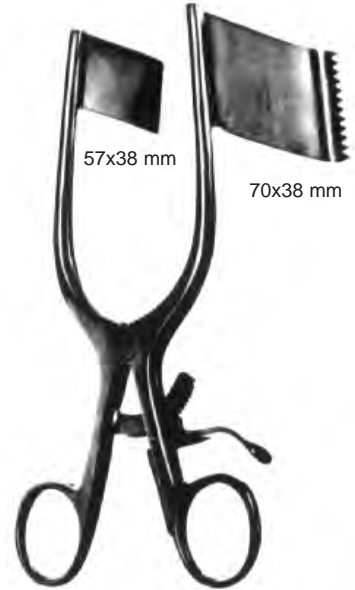

DARLING  
19698-18 18 cm, 7"



CLOWARD  
25 cm, 10"

19710-01



CLOWARD  
16 cm, 6 1/4"

19711-01



19710-40 40 mm



19710-45 45 mm



19710-50 50 mm



19710-55 55 mm



19710-60 60 mm



19711-40 40 mm



19711-45 45 mm



19711-50 50 mm



19711-55 55 mm



19711-60 60 mm

19710-00  
Sperrer komplett mit 5 Valven spitz  
Retractor complete with 5 blades sharp  
Separador completo con 5 valvas agudas  
Divaricatore completo con 5 valve acute

19712-00  
Sperrer komplett mit 5 Valven stumpf  
Retractor complete with 5 blades blunt  
Separador completo con 5 valvas romas  
Divaricatore completo con 5 valve smusse

19711-00  
Sperrer komplett mit 5 Valven spitz  
Retractor complete with 5 blades sharp  
Separador completo con 5 valvas agudas  
Divaricatore completo con 5 valve acute

19713-00  
Sperrer komplett mit 5 Valven stumpf  
Retractor complete with 5 blades blunt  
Separador completo con 5 valvas romas  
Divaricatore completo con 5 valve smusse

Laminektomie-Wundspreizer  
 Retractors, Cercical Spine  
 Separadores, columna vertebral  
 Divaricatori, spina cervicale



CASPAR  
 19720-00 compl.  
 (5 valven, 5 valves, 5 blades, 5 valvas, 5 valve)  
 19720-15  
 ohne Blätter, without blades, sin valvas, senza valve



CASPAR  
 19721-00 compl.  
 (5 valven, 5 valves, 5 blades, 5 valvas, 5 valve)  
 19721-15  
 ohne Blätter, without blades, sin valvas, senza valve



CASPAR  
 19724-00 compl. (5 valven, 5 valves, 5 blades, 5 valvas, 5 valve)  
 19724-11 ohne Blätter, without blades, sin valvas, senza valve



medial

- CASPAR
- 19724-40 40x20 mm
  - 19724-45 45x20 mm
  - 19724-50 50x20 mm
  - 19724-55 55x20 mm
  - 19724-60 60x20 mm



lateral

- CASPAR
- 19725-40 40x20 mm
  - 19725-45 45x20 mm
  - 19725-50 50x20 mm
  - 19725-55 55x20 mm
  - 19725-60 60x20 mm



Laminektomie-Wundspreizer  
 Retractors  
 Separadores  
 Divaricatori



19745-40 40 mm



19745-45 45 mm

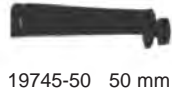

19745-50 50 mm



19745-55 55 mm



19745-60 60 mm



19745-65 65 mm



19745-70 70 mm

CASPAR

19744-00 compl. incl. 7 Blätter, compl. incl. 7 blades, valvas, valva  
 19744-17 ohne Blätter, without blades, sin valvas, senza valve



19747-45 45 mm

19747-50 50 mm

19747-55 55 mm

19747-60 60 mm

19747-65 65 mm



CASPAR  
 19747-45 - 19747-65

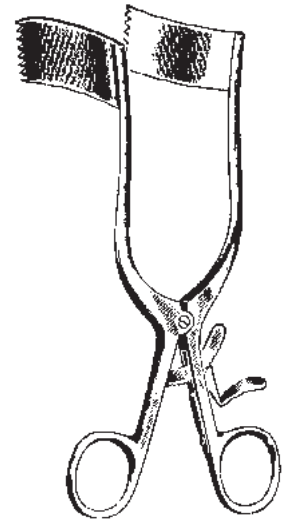

MEYERDING  
 17 cm, 6 3/4"

19748-01 2,5 x 3,2 cm

19748-02 2,5 x 5,4 cm

19748-03 1,9 x 6,0 cm

19748-04 2,5 x 6,0 cm

Bauchdeckenhalter  
 Abdominal Retractors  
 Separadores abdominales  
 Divaricatori addominali

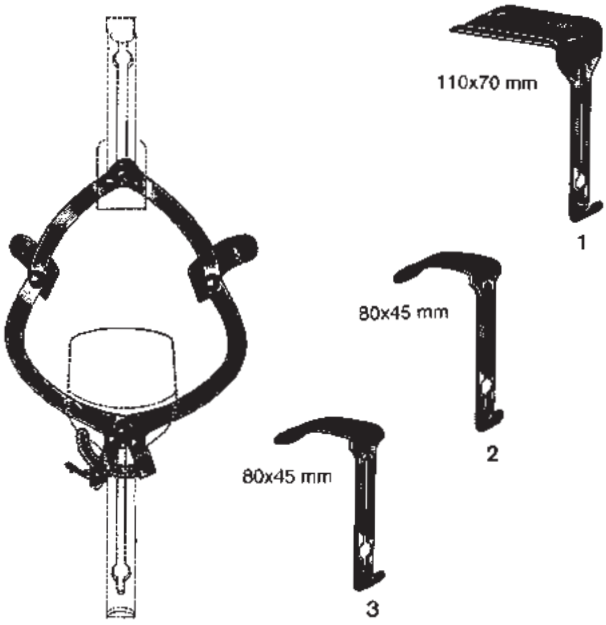

O'SULLIVAN - O'CONNOR  
 19754-00  
 compl.

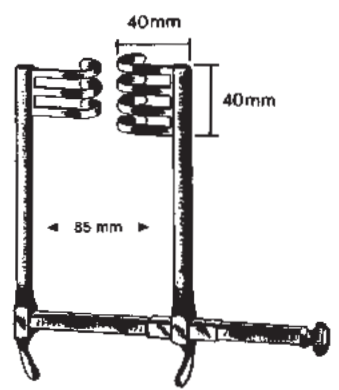

FRAZIER  
 19758-85

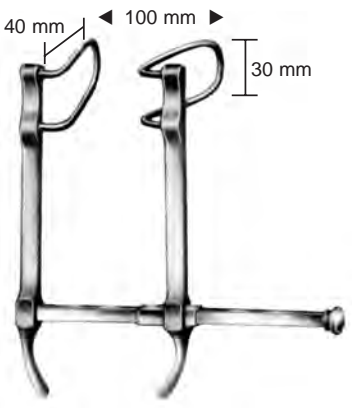

BABY GOSSET  
 19759-00

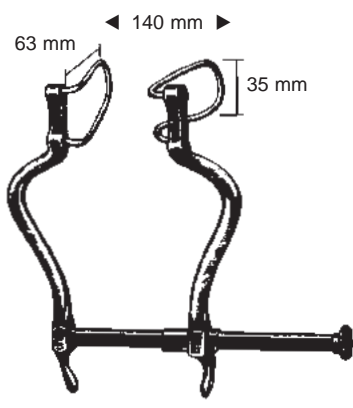

GOSSET  
 19760-14

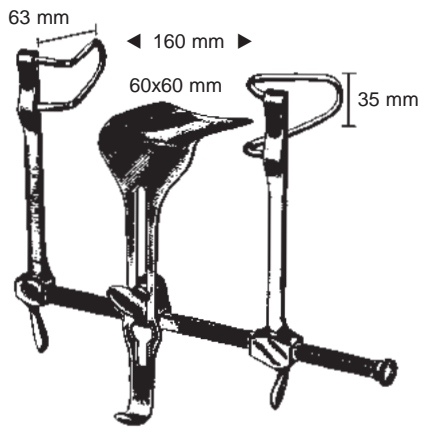

GOSSET  
 19762-16

Bauchdeckenhalter  
 Abdominal Retractors  
 Separadores abdominales  
 Divaricatori addominali

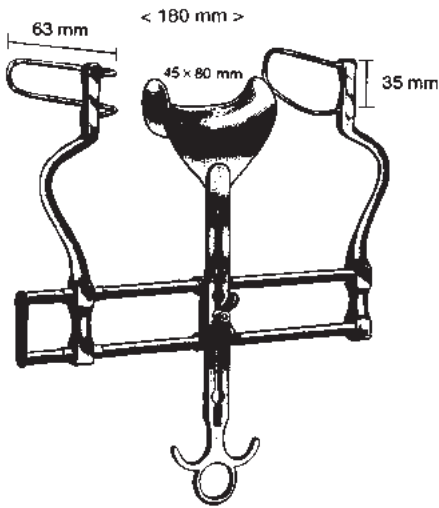

BALFOUR  
 19764-18  
 18 cm, 7"

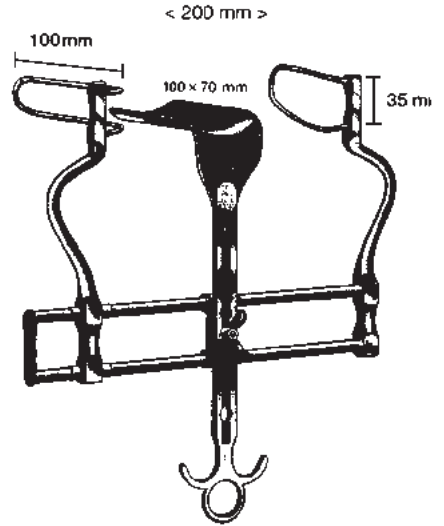

BALFOUR  
 19764-20  
 20 cm, 8"

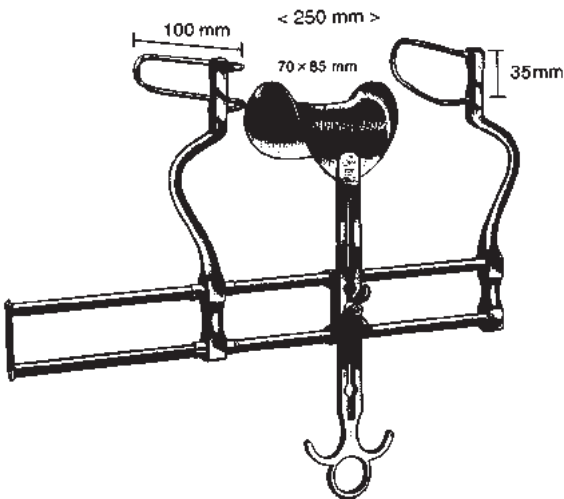

BALFOUR  
 19764-25  
 25 cm, 10"

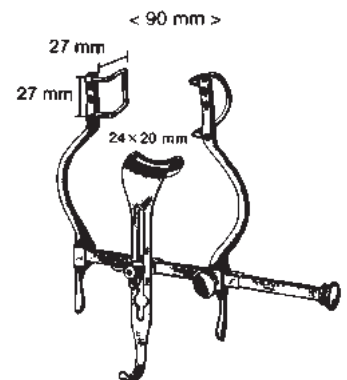

BALFOUR Baby  
 19766-90  
 9 cm, 3 1/2"

Bauchdeckenhalter  
Abdominal Retractors  
Separadores abdominales  
Divaricatori addominali

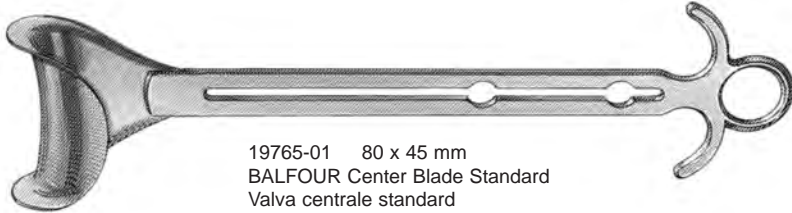

19765-01 80 x 45 mm  
BALFOUR Center Blade Standard  
Valva centrale standard  
Valva central estándar

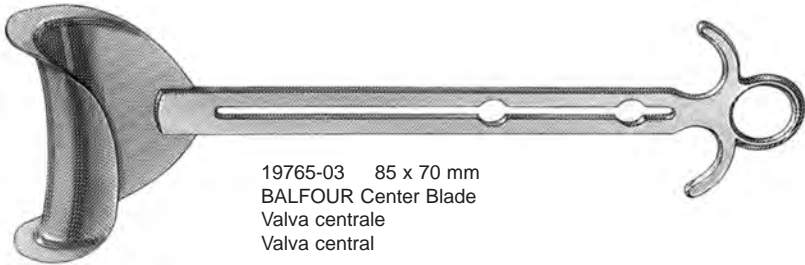

19765-03 85 x 70 mm  
BALFOUR Center Blade  
Valva centrale  
Valva central

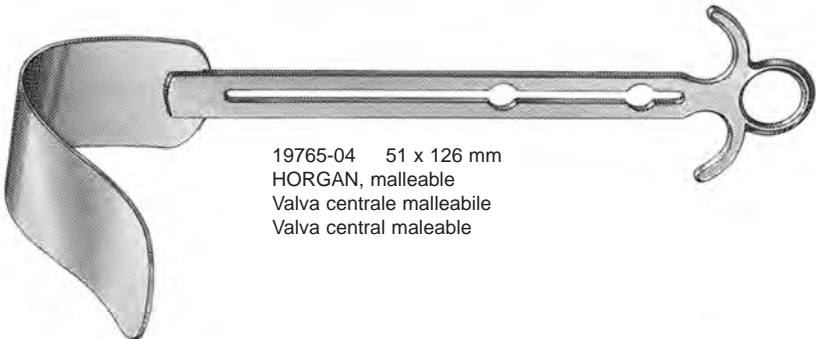

19765-04 51 x 126 mm  
HORGAN, malleable  
Valva centrale malleabile  
Valva central maleable

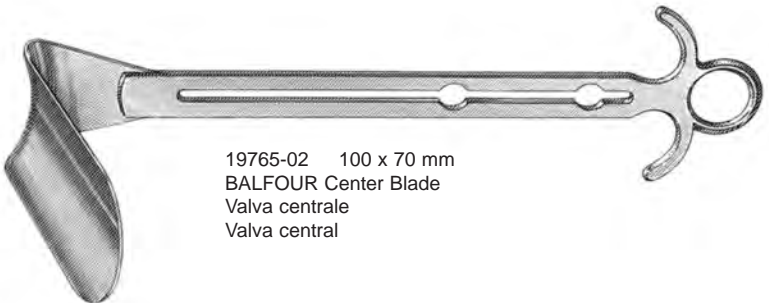

19765-02 100 x 70 mm  
BALFOUR Center Blade  
Valva centrale  
Valva central

Bauchdeckenhalter  
 Abdominal Retractors  
 Separadores abdominales  
 Divaricatori addominali



19767-01  
 Drahtvalven 6 cm (2.4") tief (Paar)  
 Fenestrated blades 6 cm (2.4") deep (pair)  
 Valvas de alambre 6 cm (2.4") profundidad (par)  
 Valve di filo profondità 6 cm (2.4") (paio)



19767-02  
 Drahtvalven 8 cm (3 1/8") tief (Paar)  
 Fenestrated blades 8 cm (3 1/8") deep (pair)  
 Valvas de alambre 8 cm (3 1/8") profundidad (par)  
 Valve di filo profondità 8 cm (3 1/8") (paio)



BALFOUR-US  
 19767-18  
 komplett  
 complete  
 completo

Bauchdeckenhalter  
Abdominal Retractors  
Separadores abdominales  
Divaricatori addominali

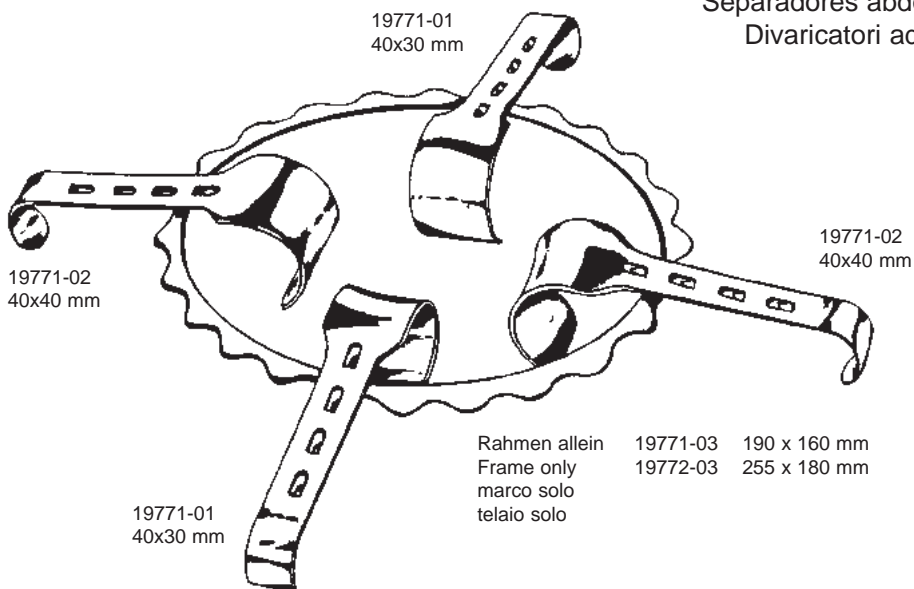

DENIS-BROWNE  
19771-00 compl. Pediatric/pediatrico 190 x 160 mm  
19772-00 compl. Adult/adulto 255 x 190 mm

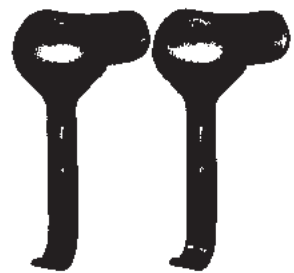

19781-55 (2 St./p.)  
40 x 55 mm breit

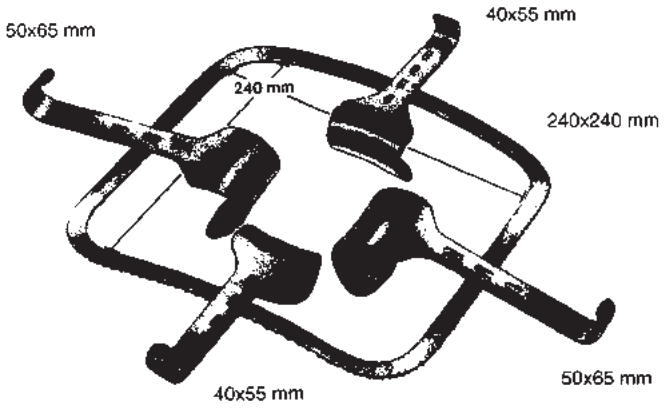

KIRSCHNER



19781-65 (2 St./p.)  
50 x 65 mm breit

19782-00 Kirschner Bauchdeckenhalter komplett bestehend aus:  
Kirschner Abdominal Retr. complete consisting of:  
Kirschner separador abdominal, completo compuesto de:  
Kirschner Divaricatore addominale completo, composto da:

- 19781-55 2 Rahmenhaken / 2 Hook-on Retr. / 2 separadores / 2 divaricatori 40 x 55 mm
- 19781-65 2 Rahmenhaken / 2 Hook-on Retr. / 2 separadores / 2 divaricatori 50 x 65 mm
- 19783-24 Rahmen fest / frame rigid / marco rigido / telaio rigido 240 x 240 mm



Bauchdeckenhalter  
Abdominal Retractors  
Separadores abdominales  
Divaricatori addominali

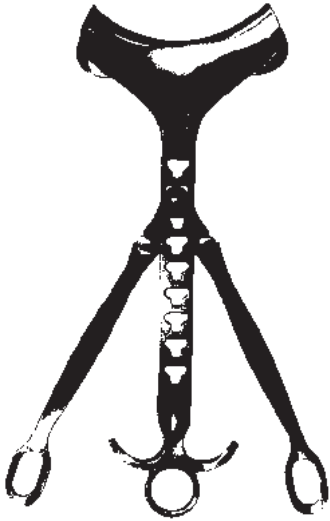

19780-01 + 19770-01

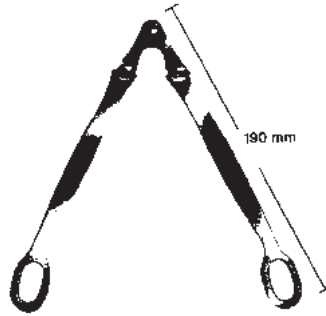

ROCHARD  
19780-01

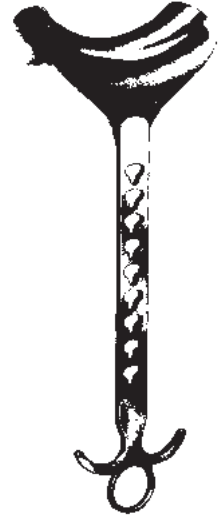

ROCHARD  
31 cm, 12 1/4"  
19770-01 48x 90 mm  
19770-02 48x105 mm  
19770-03 48x120 mm  
19770-04 48x135 mm  
19770-05 48x155 mm

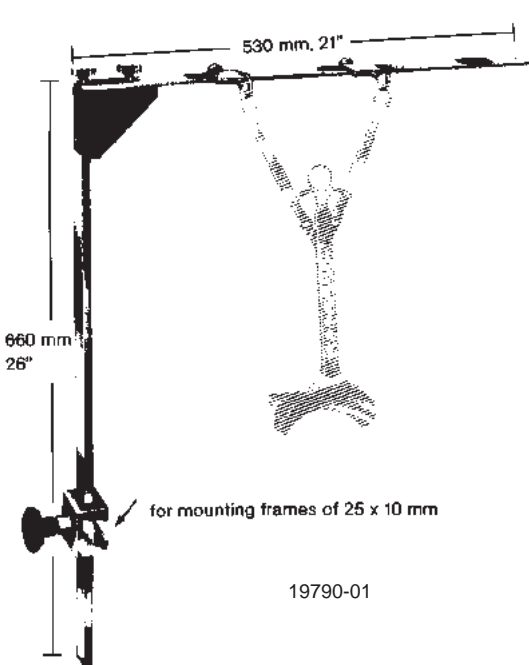

19790-01

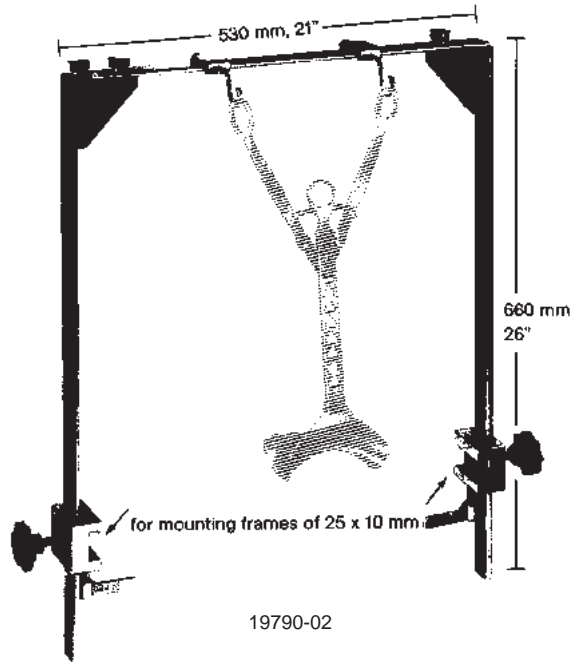

19790-02

Bauchdeckenhalter  
Abdominal Retractors  
Separadores abdominales  
Divaricatori addominali

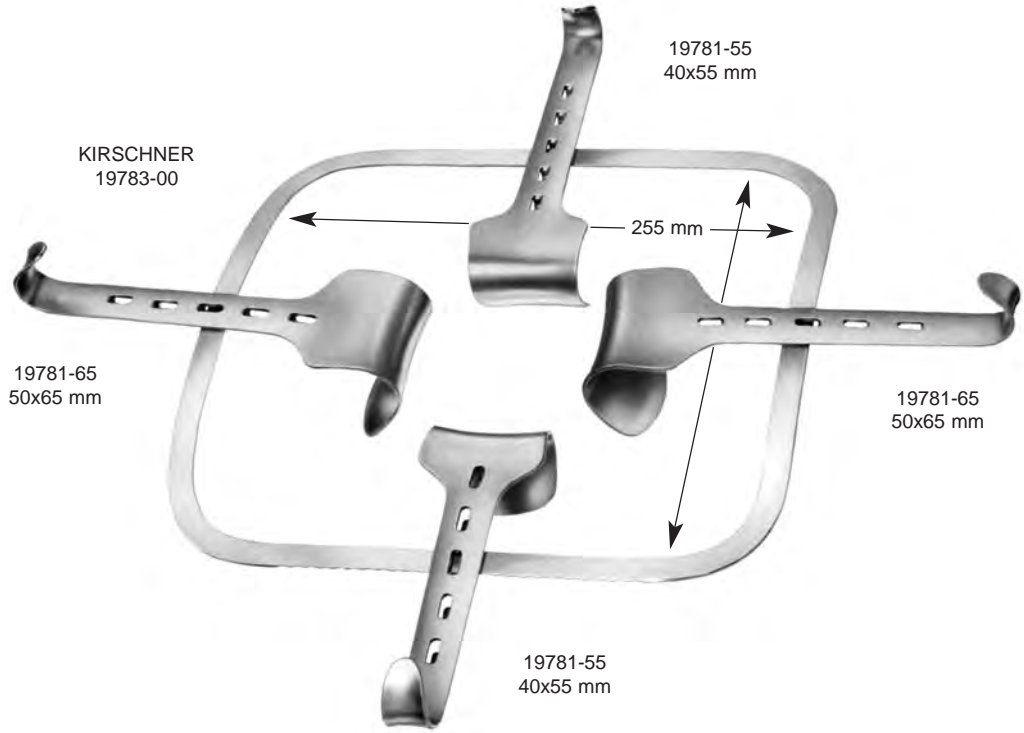

KIRSCHNER  
19783-00

19781-55  
40x55 mm

19781-65  
50x65 mm

19781-65  
50x65 mm

19781-55  
40x55 mm



19783-01 250x250 mm  
zusammenlegbarem Rahmen  
holding frame  
marco  
telaio



Bauchdeckenhalter  
 Abdominal Retractors  
 Separadores abdominales  
 Divaricatori addominali

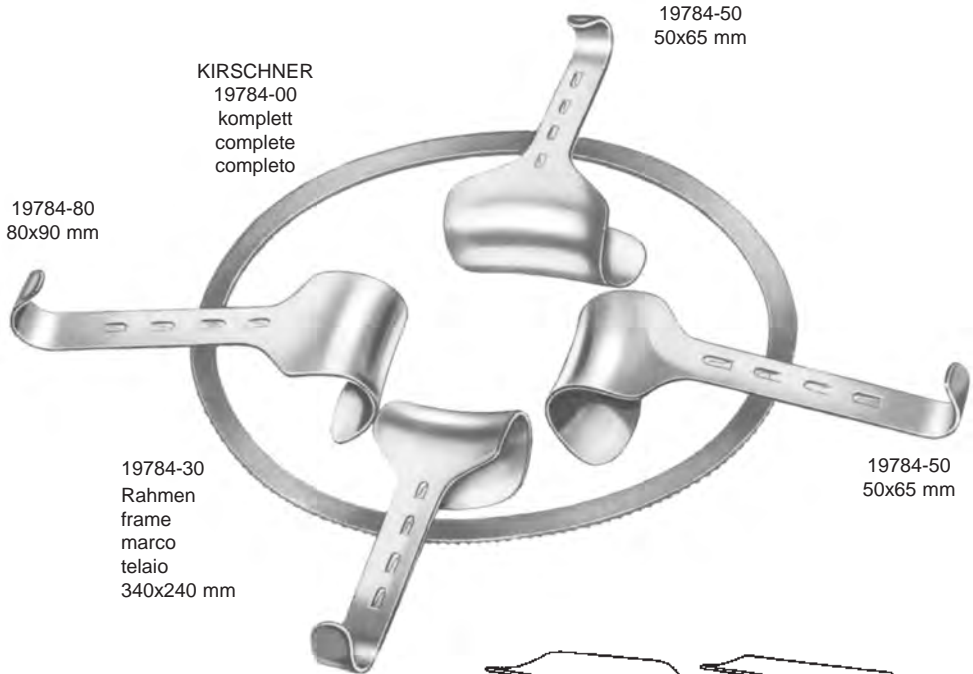

19784-50  
50x65 mm

KIRSCHNER  
19784-00  
komplett  
complete  
completo

19784-80  
80x90 mm

19784-30  
Rahmen  
frame  
marco  
telaio  
340x240 mm

19784-50  
50x65 mm

19784-80  
80x90 mm

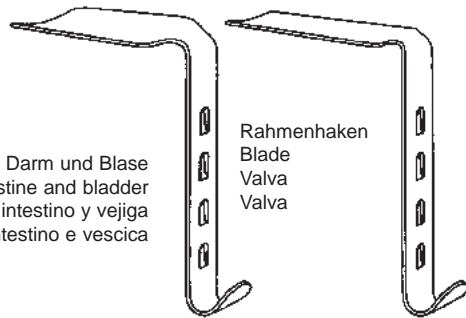

für Darm und Blase  
 for intestine and bladder  
 para intestino y vejiga  
 per intestino e vescica

Rahmenhaken  
 Blade  
 Valva  
 Valva

19784-98  
98x50 mm

19784-99  
105x35 mm

für adipöse Patienten  
 for obese patients  
 para pacientes obesos  
 per pazienti obesi



19784-40  
40x55 mm

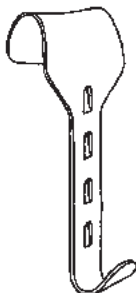

19784-50  
50x65 mm

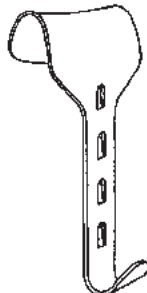

19784-60  
60x85 mm

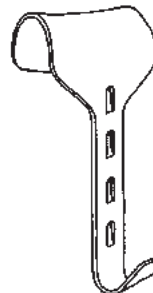

19784-78  
78x65 mm

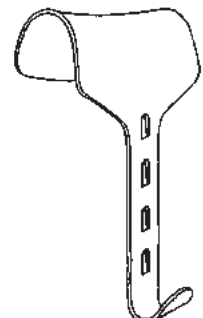

19784-80  
80x90 mm



# MAST.SH-GERMANY

Arm System

Arm System

Sistema de brazo

Sistema braccio



19795-01

Armsystem Radius 310/420 mm komplett mit Wundhakenhalter und U-Stativ Ø 16 mm, 400 mm hoch, 400 mm breit, 170 mm tief.

Arm System, radius 310/420 mm, including retractor and U-stand Ø 16 mm, 400 mm high, 400 mm wide, 170 mm deep.



19795-02

Armsystem Radius 310/420 mm komplett mit Stativ, Klemmsockel und Endoskophalter Ø 8/10 mm.

Arm System, radius 310/420 mm, including stand, clamp, endoscope holder Ø 8/10 mm.



19798-01

Einschlauchhalterung  
Single tube holder



19798-02

Endoskophalterung Universal  
Ø 3-10 mm  
Endoscope holder Universal  
Ø 3-10 mm



19798-03

Universelle  
Wundhakenhalterung  
Universal retractor holder



19798-04

Gelenkverlängerung  
180 mm lang mit Feststellung  
Extended articulation  
180 mm long, lockable



**19799-01**  
 Klemmsockel aus rostfreiem Stahl, für ein höhenverstellbares Stativ Ø 16 mm, elektrisch isoliert bis 1,5 kV AC, Spannweite 35 mm für Schienen 25/32 x 8/12 mm.  
 Clamp socket made of stainless steel, for height-adjustable stand Ø 16 mm, electrically insulated up to 1.5 kV AC, holding width of 35 mm for rails 25/32 x 8/12 mm.



**19799-02**  
 Klemmsockel aus rostfreiem Stahl, für ein höhenverstellbares Stativ Ø 16 mm, elektrisch isoliert bis 1,5 kV AC, Spannweite 35 mm für Schienen 25/32 x 8/12 mm.  
 Clamp socket made of stainless steel, for height-adjustable stand Ø 16 mm, electrically insulated up to 1.5 kV AC, holding width of 35 mm for rails 25/32 x 8/12 mm.



**19799-03**  
 Leichtmetall-Klemmsockel Spannweite 35 mm, für ein Schraubstativ mit Ø 16 mm/M10, für Schienen 25/35 x 8/10 und Rohre Ø 12 - 35 mm.  
 Clamp socket made of light metal, holding width 35 mm, for screw stand Ø 16 mm/M10, for rails 25/35 x 8/10 and tubes Ø 12 - 35 mm.



**19799-04**  
 Leichtmetall-Klemmsockel Spannweite 50 mm, für ein höhenverstellbares Stativ Ø 16 mm, für Schienen 25/35 x 8/10 und Rohre Ø 12 - 35 mm.  
 Clamp socket made of light metal, holding width 50 mm, for height-adjustable stand Ø 16 mm, for rails 25/35 x 8/10 and tubes Ø 12 - 35 mm.



**19799-05**  
 Klemmsockel aus rostfreiem Stahl, für ein höhenverstellbares Stativ Ø 16 mm, elektrisch isoliert bis 4,5 kV AC, Spannweite 50 mm für Schienen 25/32 x 8/12 mm.  
 Clamp socket made of stainless steel, for height-adjustable stand Ø 16 mm, electrically insulated up to 4.5 kV AC, holding width of 50 mm for rails 25/32 x 8/12 mm.



**19799-06**  
 Leichtmetall-Klemmsockel Spannweite 50 mm, für ein Schraubstativ mit Ø 16 mm/M10, für Schienen 25/35 x 8/10 und Rohre Ø 12 - 35 mm.  
 Clamp socket made of light metal, holding width 50 mm, for screw stand Ø 16 mm/M10, for rails 25/35 x 8/10 and tubes Ø 12 - 35 mm.



# MAST.SH-GERMANY

Bauchdeckenhalter, Wundsperrer  
Abdominal Retractors, Retractors  
Separadores abdominales, Separadores  
Divaricatori addominali, Divaricatori

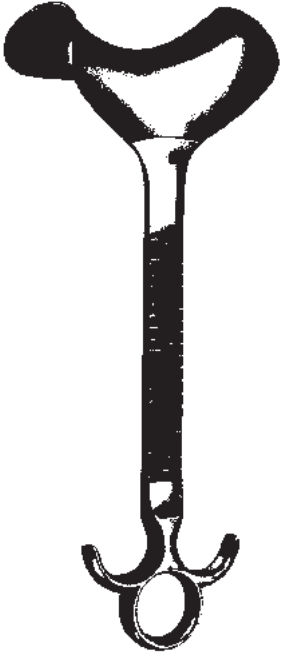

DOYEN

28 cm, 11"

- 19800-01 48x 90 mm
- 19800-02 48x105 mm
- 19800-03 48x120 mm
- 19800-04 48x135 mm

< 100 mm >

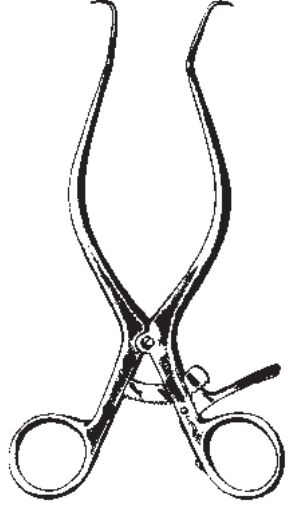

GELPI

- 19802-09 9 cm, 3 1/2"
- 19802-11 11 cm, 4 3/8"
- 19802-14 14 cm, 5 1/2"
- 19802-16 16 cm, 6 1/4"
- 19802-18 18 cm, 7"



DE BAKEY

14,5

19803-14

cm. 5 3/4"



Wundsperrer  
Retractors  
Separadores  
Divaricatori

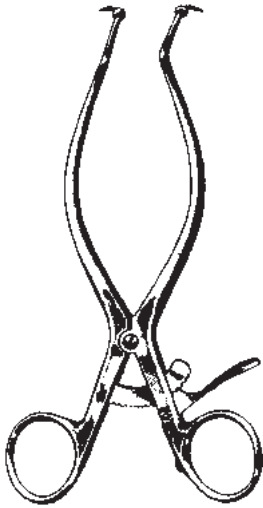

GELPI  
19804-18  
18 cm, 7"



JACKSON BURROWS  
19805-18  
18,5 cm, 7 1/4"

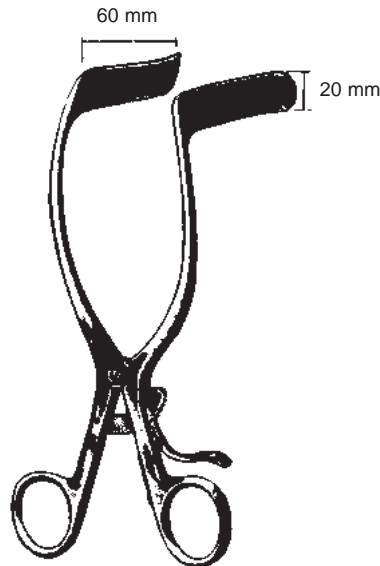

RIGBY  
19806-18  
18 cm, 7"

Bauchdeckenhalter  
Abdominal Retractors  
Separadores abdominales  
Divaricatori addominali

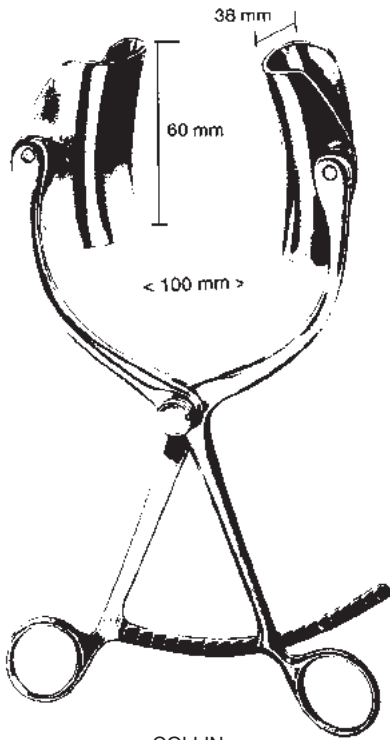

COLLIN  
19810-22

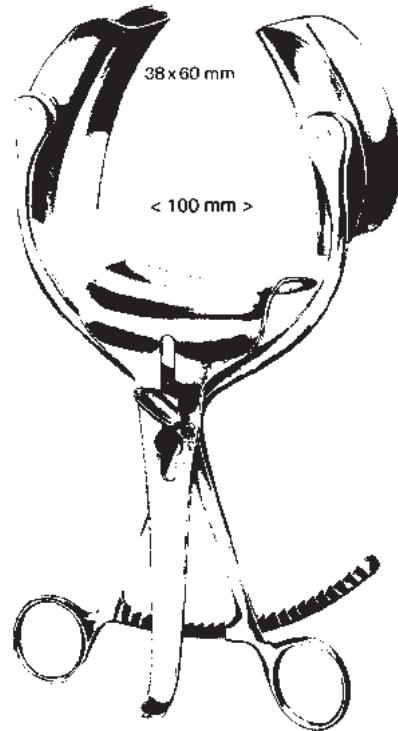

COLLIN  
19812-60



Bauchdeckenhalter  
Abdominal Retractors  
Separadores abdominales  
Divaricatori addominali

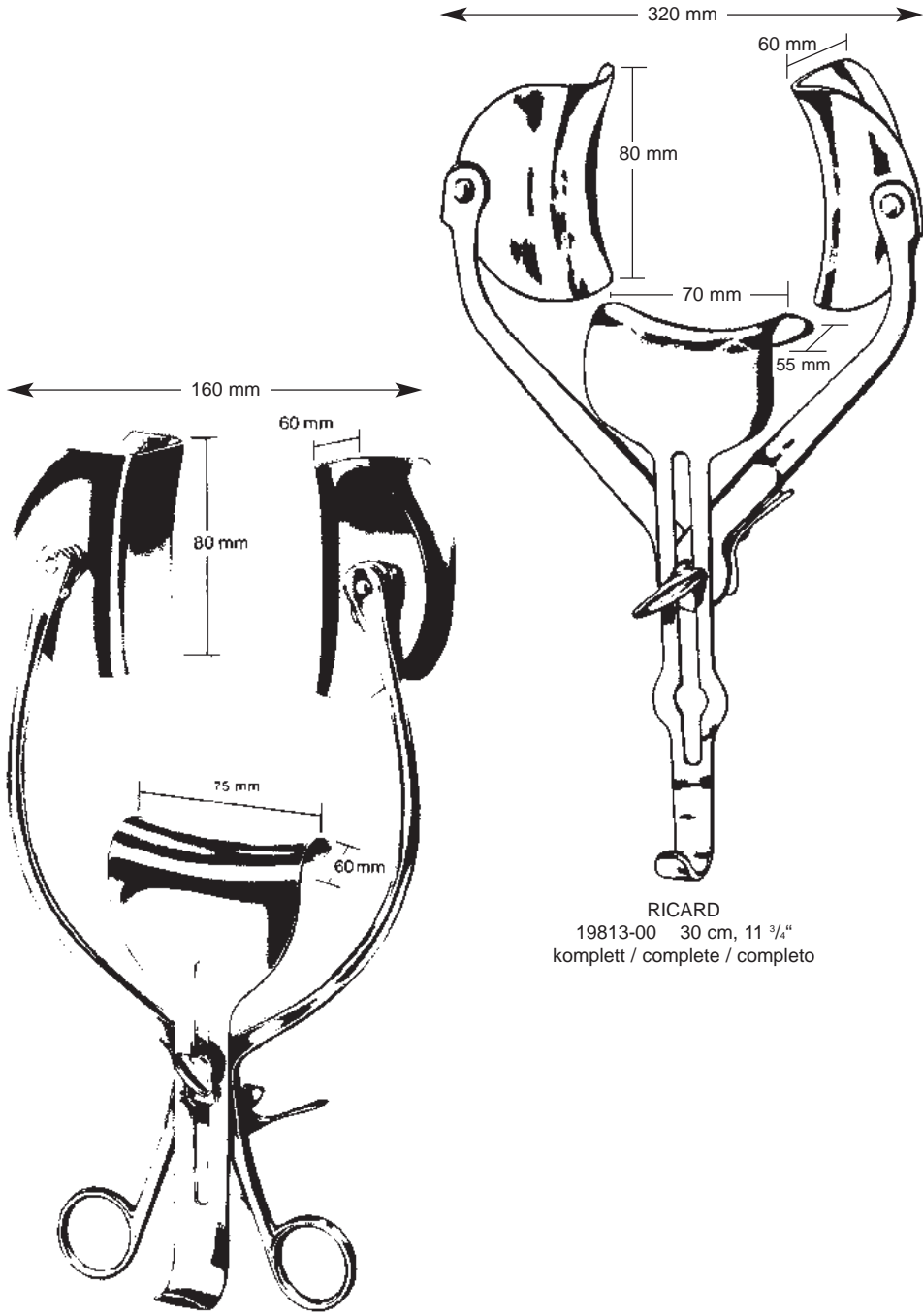

RICARD  
19813-00 30 cm, 11 3/4"  
komplett / complete / completo

COLLIN Loktite  
19816-00 31 cm, 12 1/4"  
komplett / complete / completo



# MAST.SH-GERMANY

Back holder Abdominal Retractor  
Operation Table Set

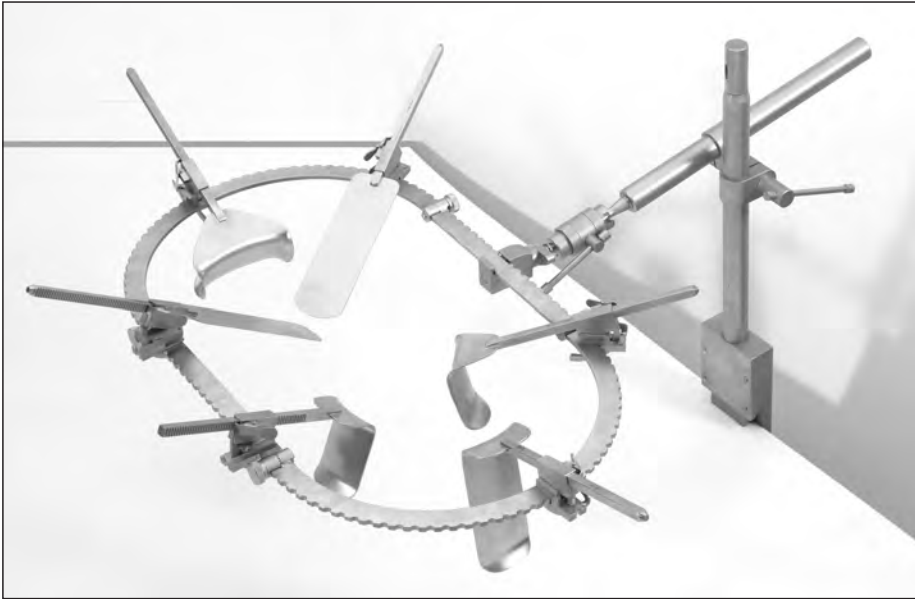

Complete Fixed Abdominal Retractor Set  
Set completo divaricatore addominale con sistema di montaggio modulare

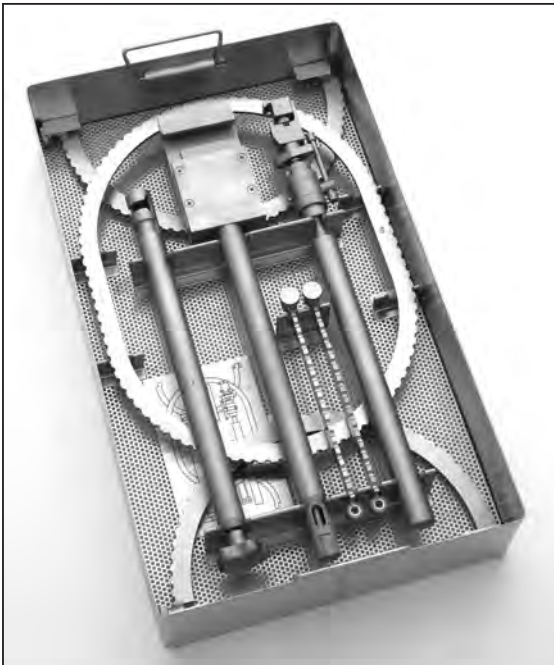

The many components of the **Back holder Abdominal Retractor Operation Table Set**

can all be neatly arranged into autoclave sized containers with diagrams that direct instrument handlers on proper placement of each component.

*A major convenience in care and maintenance of the Retractor Set*

### Sterilization Container & Baskets

#### Description

#### Product No

Table Fixation & Ring Case  
Blade & Accessories Case

19820-90  
19820-91



**Back holder Abdominal Retractor  
Operation Table Set**

<b>Description</b>	<b>Product No</b>	<i>Composto da</i>	
Complete Abdominal Retractor Set	19820-99	Accoppiatore	19821-01
<i>Includes</i>		Barra orizzontale	19821-02
Table Post	19821-01	Morsetto di accoppiamento	19821-04
Horizontal Bar	19821-02	Anello ovale	19820-02
1" Post Coupling	19821-04	No. 2 retrattori malleabili, 51x152 mm	19825-06
Oval Ring	19820-02	No. 2 Valve Kelly, dim. 51x76 mm	19822-23
2" X 6" Malleable Retractor (2 ea)	19825-06	Valva Kelly	19822-24
2" X 3" Kelly Retractor (2 ea)	19822-23	Valva Balfour	19823-33
2" X 4" Kelly Retractor	19822-24	Morsetto trasportabile con trasporto ad intervallo progressivo di 2 mm	19820-10
Balfour Retractor	19833-33	Morsetto articolato multidisciplinare con funzione movimento assiale orizzontale e verticale	19820-20
Ratchet Mechanism (2 ea)	19820-10	Anello rotondo circolare, dimensione 226 mm	19820-01
Tilt Ratchet Mechanism (6 ea)	19820-20	Anello ovale 266x367 mm	19820-02
Segmented Ring	19820-03	Anello a segmento 266x495 mm	19820-03
1 1/2" X 6" Malleable Retractor	19824-06	Retrattore malleabile 38x152 mm	19824-06
3" x 6" Malleable Retractor	19826-06	Retrattore malleabile 76x152 mm	19826-06
2" X 5" Kelly Retractor	19822-25	Valva Kelly, 51x127 mm	19822-25
2" X 6" Kelly Retractor	19822-26	Valva Kelly, 51x152 mm	19822-26
Horizontal Flex Bar	19821-03	Barra flessibile orizzontale	19821-03
Harrington Retractor	19831-25	Retrattore Harrington 63x143 mm	19831-25
Gelpi Retractor	19834-01	Retrattore con punta Gelpi	19834-01
<i>Accessories</i>		<i>Accessori:</i>	
Table Fixation & Ring Case	19820-90	<i>Container vuoto in acciaio inox dotato con griglia interna</i>	
Blades & Accessories Case	19820-91	Descrizione	
		Container in acciaio inox dotato di griglia interna per Accessori di fissazione, anelli e barre	19820-90
		Container in acciaio inox dotato di griglia interna per morsetti e divaricatori	19820-91

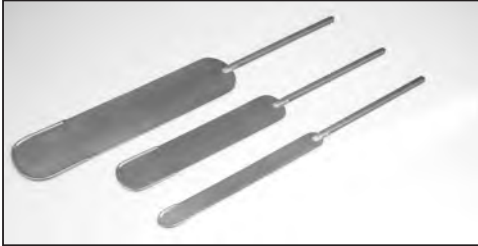

**Malleable Retractors with Protective Edge**

Description	Product No
1 1/2" x 6" 38 x 152 mm	19824-06
2" x 6" 51 x 152 mm	19825-06
3" x 6" 76 x 152 mm	19826-06

**Specialty Retractors**

Description	Product No
Balfour Retractor 2 5/8" x 3" 67 x 76 mm	19833-33
Gelpi Point Retractor	19834-01

**Harrington Retractors**

Description	Product No
Blade 2.5" x 5 5/8" 63 x 143 mm	19831-25

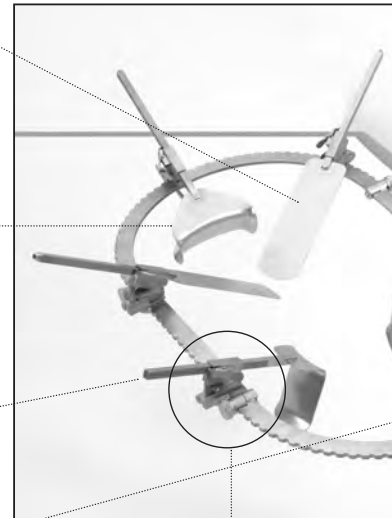

Description	Product No
Blade 2" x 1 1/2" 51 x 38 mm	19822-21
Blade 2" x 2" 51 x 51 mm	19822-22
Blade 2" x 2 1/2" 51 x 64 mm	19822-22L
Blade 2" x 3" 51 x 76 mm	19822-23
Blade 2" x 4" 51 x 102 mm	19822-24
Blade 2" x 5" 51 x 127 mm	19822-25
Blade 2" x 6" 51 x 152 mm	19822-26



Description	Product No
Blade 1" x 1 1/2" 25 x 38 mm	19822-01
Blade 1" x 2 1/2" 25 x 63 mm	19822-02



**Tilt Ratchet Mechanism** allows extensions or retractions along the horizontal axis and allows vertical movement of retractor blade with a second ratchet

**Product No** 19820-20

**Table Mounting Components**

<b>Description</b>	<b>Product No</b>
1" Post Coupler	19821-04

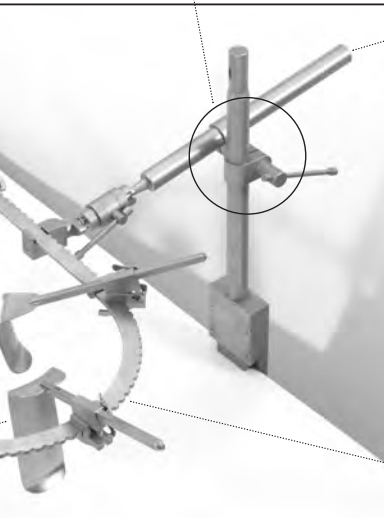

**Fixed Ratchet Mechanism** allows extension or retraction along the horizontal axis at 2mm intervals

**Product No** 19820-10

**Table Mounting Components**

Table Post	19821-01
Horizontal Bar	19821-02
Horizontal Flex Bar	19821-03

**Retractor Rings**

<b>Description</b>	<b>Product No</b>
Round Ring 10.5 inch / 266 mm	19820-01
Oval Ring 10.5 x 14.5 inch / 266 x 367 mm	19820-02
Segmented Ring 10.5 x 19.5 inch / 266 x 495 mm	19820-03
(Consists of one 10.5 inch Round Ring and two 8 inch straight segments)	



# MAST.SH-GERMANY

Laminektomiespreizer  
 Laminectomy Retractors  
 Separadores para laminectomia  
 Divaricatori per laminectomia



19910-00  
 SCOVILLE-HAVERFIELD  
 Rahmen allein  
 Frame only  
 Marco solo  
 Telaio solo



19911-00  
 SCOVILLE  
 Rahmen allein  
 Frame only  
 Marco solo  
 Telaio solo



SCOVILLE  
 50 mm, 2"  
 19912-50



SCOVILLE  
 70 mm, 2 3/4"  
 19912-70



SCOVILLE  
 19914-41 41 x 38 mm  
 19914-67 67 x 44 mm



TAYLOR  
 19915-48 48 x 50 mm  
 19915-64 64 x 50 mm  
 19916-64 64 x 64 mm  
 19916-80 80 x 57 mm



SCOVILLE  
 50 mm, 2"  
 19913-50



SCOVILLE  
 70 mm, 2 3/4"  
 19913-70



SCOVILLE  
 19917-64 64 x 25 mm  
 19918-64 64 x 50 mm  
 19918-88 88 x 25 mm

Wundhaken für plastische Chirurgie  
 Retractors for plastic surgery  
 Separadores para cirugía plástica  
 Divaricatore per chirurgia plastica



mit Kaltlicht + Absaugung  
 with cold light + aspiration  
 con luz fria + aspiracion  
 con luce fredda + aspirazione

**TEBBETTS**

19980-01	80 mm x 16 mm
19980-02	100 mm x 25 mm
19980-03	120 mm x 25 mm
19980-04	120 mm x 30 mm
19980-05	150 mm x 25 mm
19980-06	150 mm x 30 mm



**FERRIERA**

19960-01	80 mm x 16 mm
19960-02	100 mm x 25 mm
19960-03	120 mm x 25 mm
19960-04	120 mm x 30 mm
19960-05	150 mm x 25 mm
19960-06	150 mm x 30 mm

Wundhaken für plastische Chirurgie  
 Retractors for plastic surgery  
 Separadores para cirugía plástica  
 Divaricatore per chirurgia plastica



19970-01  
 37 x 70 mm  
 22 x 54 mm

BREAST  
 31 cm, 12 1/4"



CORONAL BLOW LIFT  
 19980-18  
 18 cm, 7"



YANCOSKIE  
 19990-18  
 18 cm, 7"



FREEMAN  
 19995-38 18 cm, 7"  
 38 mm, 1 1/2" wide

19995-22 18 cm, 7"  
 22 mm, 7/8" wide



ANDERSON  
 19998-03 12 cm, 4 3/4" 3 prong  
 3 rebbi

19998-05 12 cm, 4 3/4" 5 prong  
 5 rebbi



## Sonden Probes, Directors Sondas, estiletes Sonde, specilli



2 mm ø

- 11,5 cm, 4 1/2" 21102-11
- 13,0 cm, 5 1/8" 21102-13
- 14,5 cm, 5 3/4" 21102-14
- 16,0 cm, 6 1/4" 21102-16
- 18,0 cm, 7" 21102-18
- 20,0 cm, 8" 21102-20
- 25,0 cm, 10" 21102-25



1 mm ø

- 21104-11
- 21104-13
- 21104-14
- 21104-16
- 21104-18
- 21104-20
- 21104-25



2 mm ø

- 21106-11
- 21106-13
- 21106-14
- 21106-16
- 21106-18
- 21106-20
- 21106-25



21108-14  
14,5 cm, 5 3/4"



BRODIE  
21109-18  
18 cm  
7"



- 13,0 cm, 5 1/8" 21110-13
- 14,5 cm, 5 3/4" 21110-14
- 16,0 cm, 6 1/4" 21110-16
- 18,0 cm, 7" 21110-18
- 20,0 cm, 8" 21110-20



DOYEN  
21111-14  
14 cm  
5 1/2"



21112-14  
14,5 cm  
5 3/4"



STACKE  
21115-10  
10,5 cm  
4.1"



NELATON  
21120-16  
16 cm  
6 1/4"



FISH  
21121-14  
14 cm, 5 1/2"  
21121-18  
18 cm, 7"



WATSON-CHEYNE  
21122-13  
13 cm, 5 1/8"  
21122-18  
18 cm, 7"

Fistelsonden  
Fistula Probes  
Sondas para fistula  
Sonde per fistole



LOCKHART-MUMMERY  
21125-01  
16,5 cm, 6 1/2"

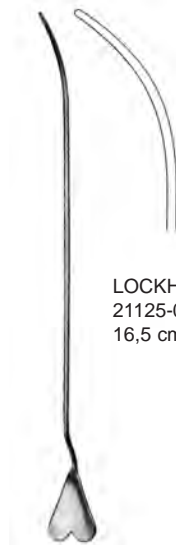

LOCKHART-MUMMERY  
21125-02  
16,5 cm, 6 1/2"



LOCKHART-MUMMERY  
21125-03  
16,5 cm, 6 1/2"



LOCKHART-MUMMERY  
21125-04  
16,5 cm, 6 1/2"





Krampfader-Besteck in Metalletui  
Varicose vein probe set in metal case  
Juego para várices en estuche de metal  
Astuccio per varici in scatola di metallo

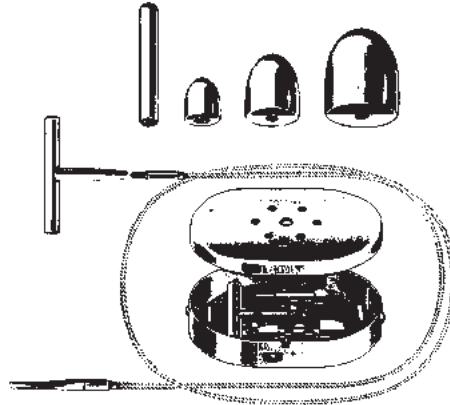

NABATOFF  
21150-00  
135x100x25 mm  
compl.

Ersatzteile  
Spare parts  
Piezas de repuesto  
Pezzi di ricambio

21150-02

21150-80

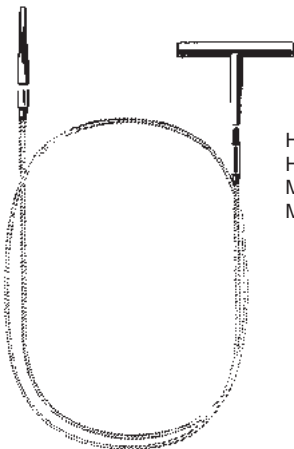

Handgriff  
Handle only  
Mango suelto  
Manico solo

21150-90

Zugseil  
cable flexible  
cable de traccion flex.  
Corda di trazione fless.



21150-03  
3 mm ø



21150-06  
6 mm ø



21150-09  
9 mm ø



21150-12  
12 mm ø



21150-15  
15 mm ø

Sondenspitzen  
Probe Tip  
Puntas sueltas  
Punte

Varizeninstrumente  
 Varix Instruments  
 Instrumentos para varices  
 Strumenti per varici



VARADY  
 21154-01  
 180 mm, 7"



VARADY  
 21154-02  
 180 mm, 7"



VARADY  
 21154-03  
 180 mm, 7"



VARADY  
 21154-04  
 175 mm, 6.9"



VARADY  
 21154-05  
 170 mm, 6 3/4"



VARADY  
 21154-06  
 170 mm, 6 3/4"

21162-12  
 12 cm, 4 3/4"  
 Griff  
 Handle  
 Mango  
 Manico



21160-04  
 —  
 21160-14

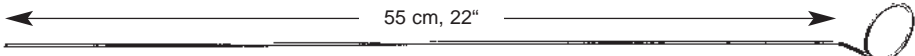

55 cm, 22"



21160-04  
 4 mm ø

21160-06  
 6 mm ø

21160-07  
 7 mm ø

21160-08  
 8 mm ø

21160-10  
 10 mm ø

21160-12  
 12 mm ø

21160-14  
 14 mm ø



Watteträger, Spatel  
 Cotton Applicators, Spatulas  
 Porta-algodones, Espátulas  
 Portacotone, Spatole



FARRELL

4 3/4"	21270-12	12,0 cm
5 1/2"	21270-14	14,0 cm
6 1/2"	21270-16	16,5 cm
7"	21270-18	18,0 cm
9"	21270-23	23,0 cm



FARRELL

4 3/4"	21272-12	12,0 cm
5 1/2"	21272-14	14,0 cm
6 1/2"	21272-16	16,5 cm
7"	21272-18	18,0 cm
9"	21272-23	23,0 cm



REDA

4 3/4"	21290-12	12,0 cm
5 1/2"	21290-14	14,0 cm
6 1/4"	21290-16	16,0 cm
7"	21290-18	18,0 cm

1,5



REDA

4 3/4"	21292-12	12,0 cm
5 1/2"	21292-14	14,0 cm
6 1/4"	21292-16	16,0 cm
7"	21292-18	18,0 cm

1,5

Spatel  
 Plaster spatula  
 Espátula  
 Spatole



21190-14  
 14,5 cm, 5 3/4"



UCKERMANN  
 21310-15  
 15 cm, 6"



JOBSON-HORNE  
 21320-12 12 cm, 4 3/4"  
 21320-18 18 cm, 7"

ø 3 mm



TOBOLD  
 21331-25  
 25 cm, 10"



21340-45  
 45 cm, 17 3/4"

Trokare  
Trocars  
Trócares  
Trequarti

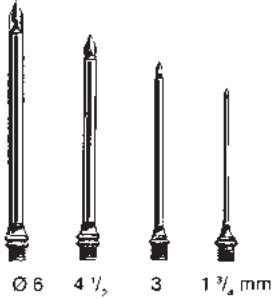

UNIVERSAL  
23104-00  
compl.



STANDARD (Nelson)  
23110-30 3,0 mm ø  
23110-35 3,5 mm ø  
23110-40 4,0 mm ø  
23110-45 4,5 mm ø  
23110-50 5,0 mm ø  
23110-55 5,5 mm ø  
23110-60 6,0 mm ø



PIERCE  
23123-30 3,0 mm Ø  
23123-40 4,0 mm Ø  
23123-50 5,0 mm Ø



DOUGLAS  
23125-11 3 mm Ø



LICHTWITZ  
23128-19 1,75 mm Ø

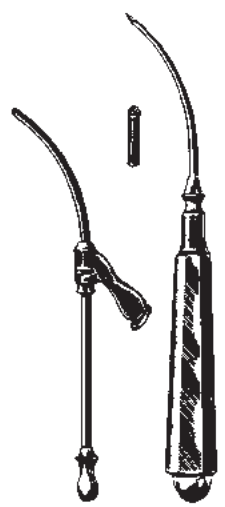

COAKLEY  
23140-02 2,25 mm Ø



Trokare  
Trocars  
Trócares  
Trequarti

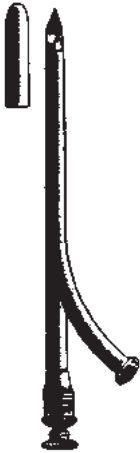

Charr./	
F.G.	OCHSNER
10	23150-10
12	23150-12
14	23150-14
16	23150-16
18	23150-18
20	23150-20



Charr./		
F.G.	NELSON	ø
25	23170-25	7,5 mm
30	23170-30	9,0 mm
33	23170-33	10,5 mm
35	23170-35	12,0 mm



SINOSKOPIE-TROKAR  
universal  
8,5 cm, 3.4"

23180-27 f. Optik mit Ø 2,7 mm  
23180-40 f. Optik mit Ø 4,0 mm



SINOSKOPIE-TROKAR  
abgeschrägt/oblique beak  
8,5 cm, 3.4"

23181-40 f. Optik mit Ø 4,0 mm



# MAST.SH-GERMANY

Biopsiekanülen  
 Biopsy Needles  
 Aguja para biopsia  
 Aghi per biopsia

Nadelführer  
 Pudendus  
 Anesthésie  
 anestesia



IOWA  
 23210-00  
 compl.



VERRES  
 23250-20 2,00x100 mm  
 23250-40 2,00x140 mm

Pneumoperitoneum  
 Pneumoperitoneum  
 Neumoperitoneo  
 Pneumoperitoneo



MENGHINI  
 23302-01 1,0x 35 mm  
 23302-02 1,0x 70 mm  
 23302-03 1,2x 70 mm  
 23302-04 1,2x100 mm  
 23302-05 1,4x 70 mm  
 23302-06 1,4x100 mm  
 23302-07 1,6x 70 mm  
 23302-08 1,8x100 mm



MENGHINI  
 23310-14 1,4x168 mm  
 23310-18 1,8x168 mm

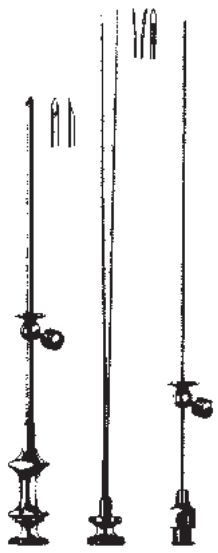

FRANKLIN-SILVERMANN  
 23330-20 2,0x105 1,5x155  
 23330-14 2,0x130 1,5x180  
 compl.

Biopsienadel  
 Biopsy needle  
 Aguja para biopsia  
 Ago per biopsia



Spaltnadel  
 Bifurcated  
 Aguja bifurcada  
 Ago biforcuto

FRANKLIN-SILVERMANN  
 A ø mm B ø mm A+B  
 23351-20 2,0x100 23352-15 1,5x150 23350-20  
 23351-30 2,5x145 23352-20 2,0x195 23350-30



**MAST.SH-GERMANY**

Führungsnadeln

Guide needles

Aguja de Guía

Ago guida

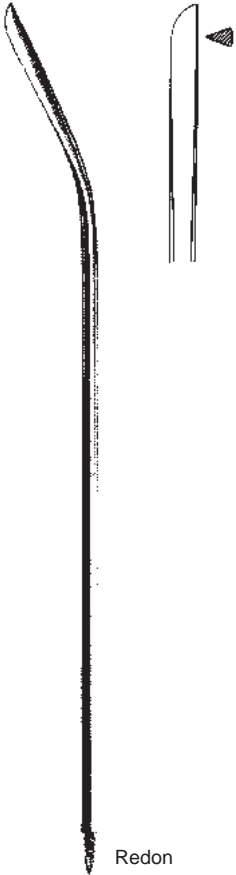

Redon

23195-08 - 23195-18

Führungsnadel, gerade  
Guide Needle, straight  
Aguja de guía, recta  
Ago guida, retta

Charr./Fr.  
8 23195-08  
10 23195-10  
12 23195-12  
14 23195-14  
16 23195-16  
18 23195-18



Redon

23197-08 - 23197-18

Führungsnadel, gebogen  
Guide Needle, curved  
Aguja de guía, curva  
Ago guida, curva

Charr./Fr.  
8 23197-08  
10 23197-10  
12 23197-12  
14 23197-14  
16 23197-16  
18 23197-18

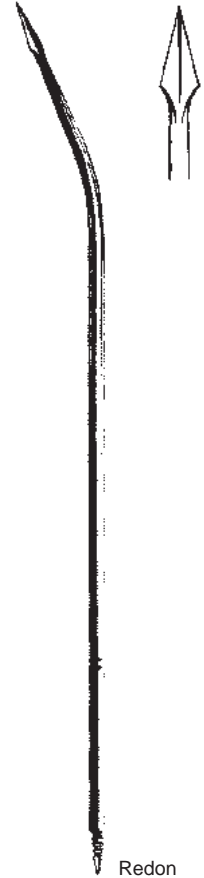

Redon

23198-08 - 23198-18

Führungsnadel, Lanzettspitze  
Guide Needle, with lancet tip  
Aguja de guía, con punta lanceolar  
Ago guida, con punta lanceolata

Charr./Fr.  
8 23198-08  
10 23198-10  
12 23198-12  
14 23198-14  
16 23198-16  
18 23198-18

Nadelhalter  
 Needle Holders  
 Porta-agujas  
 Port'aghi

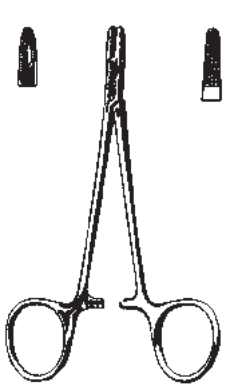

DERF  
 25110-12  
 12 cm, 4 3/4"  
 25114-12 TC  
 12 cm, 4 3/4"



DERF  
 25120-12  
 12,5 cm, 5"

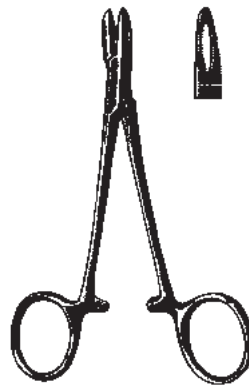

COLLIER  
 25122-12  
 12,5 cm, 5"

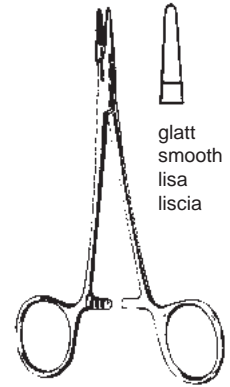

glatt  
 smooth  
 lisa  
 liscia

WEBSTER  
 25128-13  
 13 cm, 5 1/8"  
 25129-13 TC  
 13 cm, 5 1/8"

BABY-WEBSTER  
 25136-11  
 11 cm, 4 3/8"  
 25137-11 TC  
 11 cm, 4 3/8"

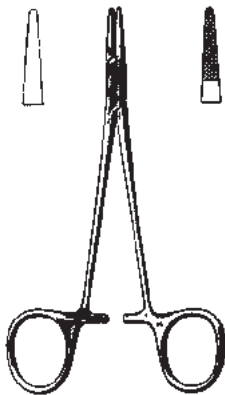

HALSEY  
 25130-13 25140-13  
 25134-13 TC 25144-13 TC  
 13 cm, 5 1/8"

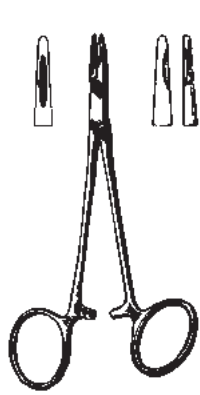

NEIVERT  
 25146-13  
 13 cm, 5 1/8"



NEIVERT  
 25148-13 TC  
 13 cm, 5 1/8"

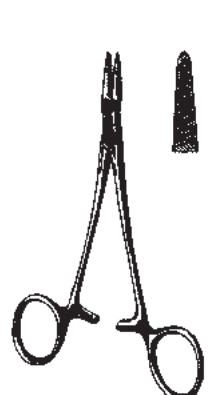

BAUMGARTNER  
 25150-12 25154-12 TC  
 12,5 cm, 5"  
 25150-14 25154-14 TC  
 14,0 cm, 5 1/2"





Nadelhalter  
Needle Holders  
Porta-agujas  
Port'aghi



CRILE-WOOD

- |          |           |             |
|----------|-----------|-------------|
| 25160-15 | 15 cm, 6" | 25164-15 TC |
| 25160-18 | 18 cm, 7" | 25164-18 TC |
| 25160-20 | 20 cm, 8" | 25164-20 TC |
| 25160-23 | 23 cm, 9" | 25164-23 TC |



CRILE-MURRAY

- |          |             |
|----------|-------------|
| 25170-15 | 25174-15 TC |
|          | 15 cm, 6"   |

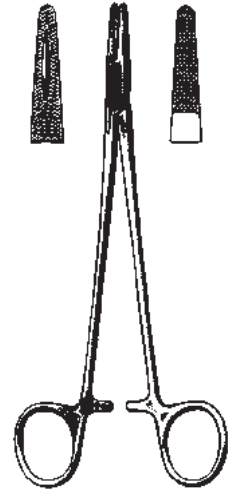

MAYO-HEGAR

- |          |                |             |
|----------|----------------|-------------|
| 25180-12 | 12 cm, 4 3/4"  | 25184-12 TC |
| 25180-14 | 14 cm, 5 1/2"  | 25184-14 TC |
| 25180-16 | 16 cm, 6 1/4"  | 25184-16 TC |
| 25180-18 | 18 cm, 7"      | 25184-18 TC |
| 25180-20 | 20 cm, 8"      | 25184-20 TC |
| 25180-24 | 24 cm, 9 1/2"  | 25184-24 TC |
| 25180-26 | 26 cm, 10 1/4" | 25184-26 TC |
| 25180-30 | 30 cm, 11 3/4" | 25184-30 TC |

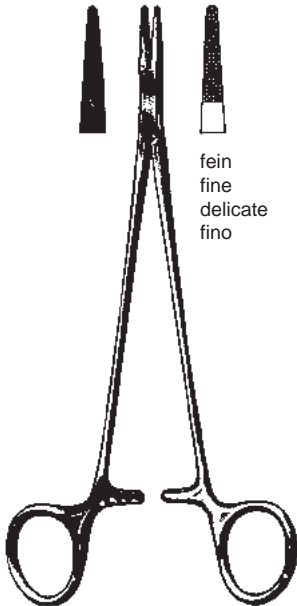

fein  
fine  
delicate  
fino

MAYO-HEGAR

- |          |               |             |
|----------|---------------|-------------|
| 25190-16 | 16 cm, 6 1/4" | 25194-16 TC |
| 25190-18 | 18 cm, 7"     | 25194-18 TC |
| 25190-20 | 20 cm, 8"     | 25194-20 TC |

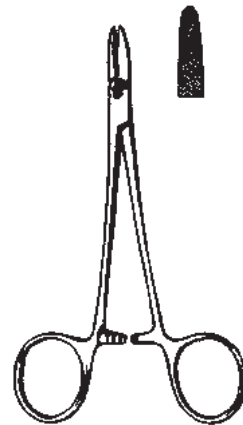

BROWN 25196-13 13 cm, 5 1/8"

- |          |           |
|----------|-----------|
| 25196-18 | 18 cm, 7" |
|----------|-----------|

Nadelhalter  
Needle Holders  
Porta-agujas  
Port'aghi



DE BAKLEY

25214-16 TC	16 cm, 6 1/4"
25214-18 TC	18 cm, 7"
25214-20 TC	20 cm, 8"
25214-23 TC	23 cm, 9"
25214-26 TC	26 cm, 10 1/4"
25214-31 TC	31 cm, 12 1/4"



RYDER 1 mm

25224-13 TC	13 cm, 5 1/8"
25224-15 TC	15 cm, 6"
25224-18 TC	18 cm, 7"
25224-20 TC	20 cm, 8"
25224-23 TC	23 cm, 9"
25224-26 TC	26 cm, 10 1/4"

RYDER 2 mm

25225-13 TC	
25225-15 TC	
25225-18 TC	
25225-20 TC	
25225-23 TC	
25225-26 TC	

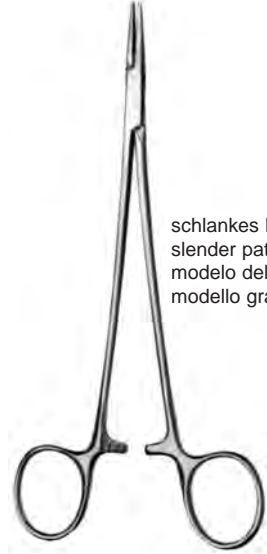

schlankes Modell  
slender pattern  
modelo delgado  
modello gracile

MICROVASCULAR

25230-18 TC	18 cm, 7"
25230-20 TC	20 cm, 8"
25230-23 TC	23 cm, 9"



HEANEY

25241-21	21 cm, 8 1/4"
25241-26	26 cm, 10 1/4"
25245-21 TC	21 cm, 8 1/4"

25245-26 TC 26 cm, 10 1/4"



MASSON

25250-27	27 cm, 10 1/2"
25254-27 TC	27 cm, 10 1/2"



WANGENSTEEN

25260-27	27 cm, 10 1/2"
25264-27 TC	27 cm, 10 1/2"



Nadelhalter  
Needle Holders  
Porta-agujas  
Port'aghi

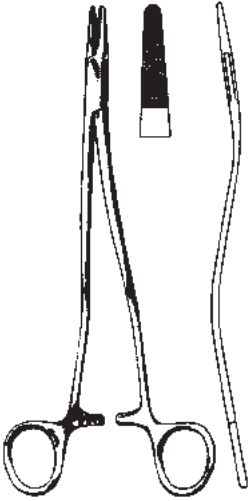

**BOZEMANN**

- 25285-20 TC 20 cm, 8"
- 25285-24 TC 24 cm, 9 1/2"
- 25285-26 TC 26 cm, 10 1/4"



**METZENBAUM**

- 25290-18
- 18 cm, 7"



**ADSON**

- 25292-18
- 18 cm, 7"

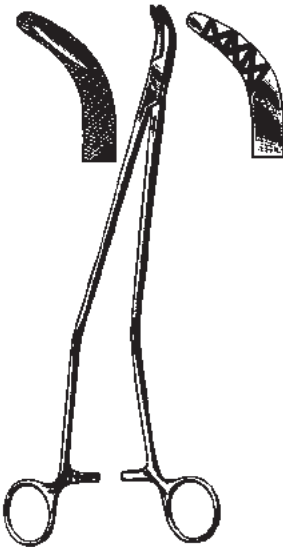

**JOHNSON**

- 25293-27
- 27 cm, 10 1/2"



**FINOCHIETTO**

- 25311-20 20 cm, 8"
- 25311-27 27 cm, 10 1/2"
- 25315-20 TC
- 25315-27 TC



**SAROT**

- 25324-18 TC 18 cm, 7"
- 25324-26 TC 26 cm, 10 1/4"

Nadelhalter  
Needle Holders  
Porta-agujas  
Port'aghi

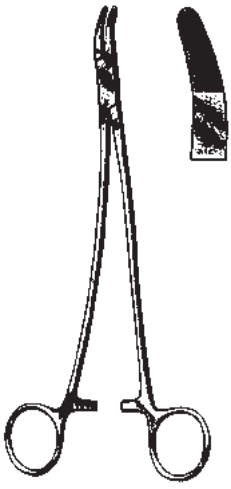

**STRATTE**  
25330-21 21 cm, 8 1/4"  
25330-23 23 cm, 9" **25334-23 TC**

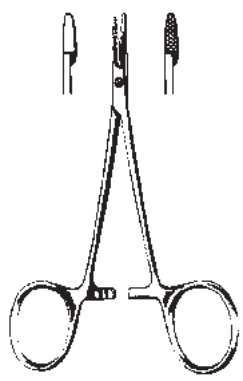

**BABY-OLSEN-HEGAR**  
25405-12 25406-12  
**25408-12 TC 25407-12 TC**  
11,5 cm, 4 1/2"

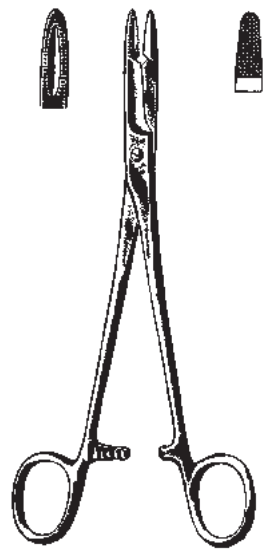

**OLSEN-HEGAR**  
25410-14 14 cm, 5 1/2" **25414-14 TC**  
25410-17 17 cm, 6 3/4" **25414-17 TC**  
18 cm, 7" **25414-18 TC**



**MATHIEU-OLSEN**  
**25415-14 TC** 14 cm, 5 1/2"  
" **25415-17 TC** 17 cm, 6 3/4"  
" **25415-20 TC** 20 cm, 8"

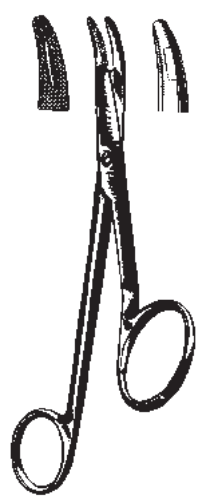

**GILLIES**  
25430-16 11 cm, 4 3/8" **25434-11 TC**  
13 cm, 5 1/8" **25434-13 TC**  
16 cm, 6 1/4" **25434-16 TC**

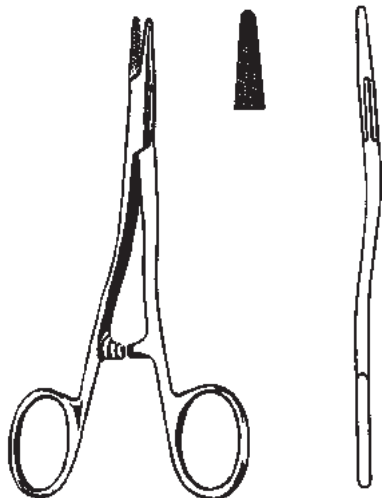

**KILNER**  
**25436-13** 13 cm, 5 1/8"  
**25438-13 TC** 13 cm, 5 1/8"

Nadelhalter  
Needle Holders  
Porta-agujas  
Port'aghi



HOESEL

25446-25 25 cm, 10"  
25447-25 TC 25 cm, 10"



CRILE

25438-15 15 cm, 6"

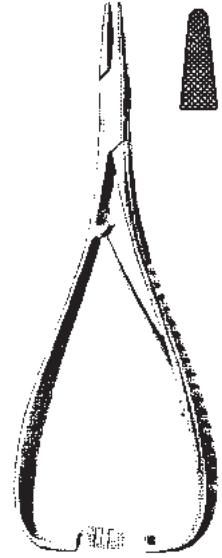

MATHIEU

25450-14 14 cm, 5 1/2" 25452-14 TC  
25450-17 17 cm, 6 3/4" 25452-17 TC  
25450-20 20 cm, 8" 25452-20 TC  
25450-24 24 cm, 9 1/2" 25452-24 TC

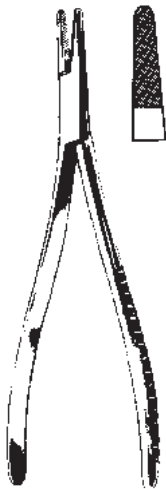

LANGENBECK

25460-18 TC 18 cm, 7"  
25460-20 TC 20 cm, 8"  
25460-23 TC 23 cm, 9"

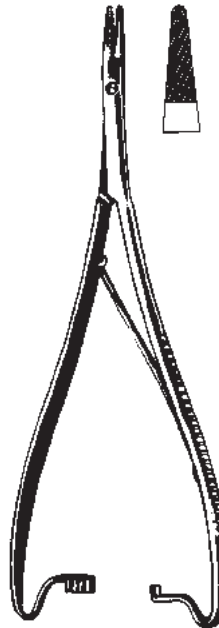

HOESEL

25465-20 TC 20 cm, 8"  
25465-25 TC 25 cm, 10"



LICHTENBERG

25466-17 17 cm, 6 3/4" 25467-17 TC  
25466-20 20 cm, 8" 25467-20 TC



# MAST.SH-GERMANY

Nadelhalter  
Needle Holders  
Porta-agujas  
Port'aghi

Oftalmologie  
Ophthalmology  
Oftalmologia  
Oftalmologia



STEVENS  
25610-11  
11 cm, 4 3/8"



STEVENS  
25612-13 13 cm, 5 1/8"  
25612-15 15 cm, 6"



BOYNTON  
25614-12  
12 cm, 4 3/4"



BOYNTON  
**25615-12 TC**  
12 cm, 4 3/4"

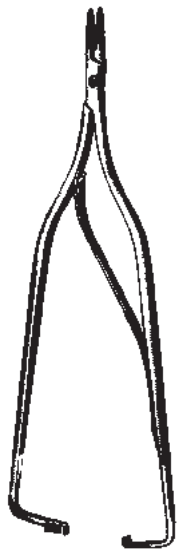

ARRUGA  
25620-16 - 25624-16  
16 cm, 6 1/4"

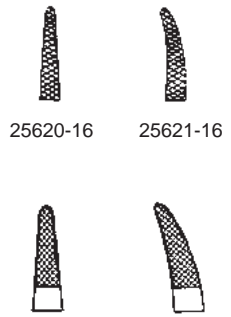

25620-16 25621-16

**25624-16 TC** 25625-16 TC



KALT-ARRUGA  
25627-14  
14 cm, 5 1/2"



KALT  
25628-14  
14 cm, 5 1/2"

Nadelhalter  
Needle Holders  
Porta-agujas  
Port'aghi

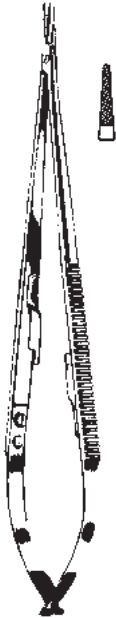

JACOBSEN  
25667-18 18 cm, 7"  
**25668-18 TC** 18 cm, 7"  
25667-21 21 cm, 8 1/4"  
**25668-21 TC** 21 cm, 8 1/4"



CASTROVIEJO  
14 cm, 5 1/2"



25670-14  
glatt  
smooth  
lisa  
liscia



25672-14  
gerieft  
serrated  
estriada  
zigrinato



**25676-14 TC**



25671-14  
glatt  
smooth  
lisa  
liscia



25673-14  
gerieft  
serrated  
estriada  
zigrinato



**25677-14 TC**



25678-09



CASTROVIEJO-MICRO  
9 cm, 3 1/2"



25679-09



CASTROVIEJO  
25680-13 13 cm, 5 1/8"  
**25684-13 TC** 13 cm, 5 1/8"

Mikro-Nadelhalter  
 Micro-Needle Holders  
 Micro-Porta-agujas  
 Micro-Port'aghi



CASTROVIEJO-STANDARD  
 25678-14 14 cm, 5 1/2"



CASTROVIEJO-STANDARD  
 25679-14 14 cm, 5 1/2"

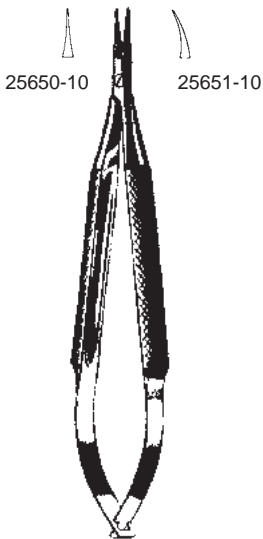

BARRAQUER  
 10 cm, 4"



BARRAQUER-TROUTMAN  
 10 cm, 4"



Mikro-Nadelhalter  
 Micro-Needle Holders  
 Micro-Porta-agujas  
 Micro-Port'aghi

25660-13      25661-13



**BARRAQUER**  
 13 cm, 5 1/8"

25720-14      25721-14  
**25722-14 TC**      **25723-14 TC**



**BARRAQUER**  
 14 cm, 5 1/2"

25700-18      25701-18



**BARRAQUER**  
 18 cm, 7"

25730-18      25731-18



**BARRAQUER**  
 18 cm, 7"

Unterbindungsnadeln  
 Ligature Needles  
 Aguja para ligaduras  
 Aghi per legature



biegsam  
 malleable  
 malleable  
 malleabile

27109-20

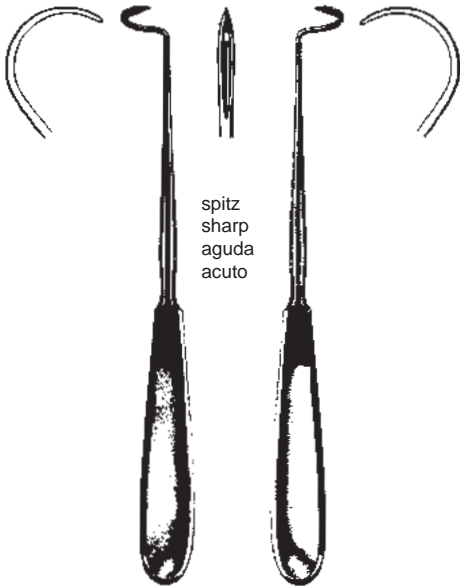

spitz  
 sharp  
 aguda  
 acuto

	L	DESCHAMPS	R
	27110-21	21 cm, 8 1/4"	27111-21
	27110-24	24 cm, 9 1/2"	27111-24
	27110-27	27 cm, 10 1/2"	27111-27

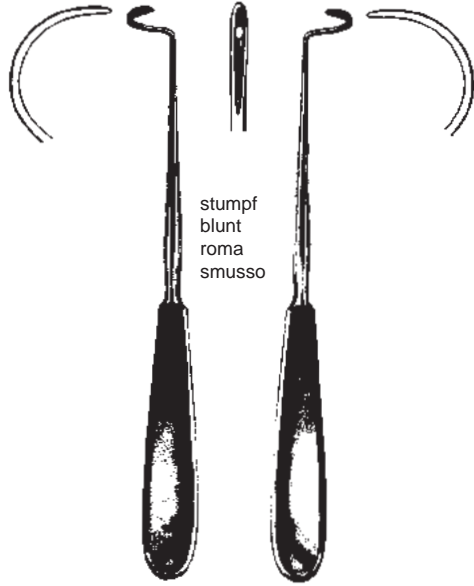

stumpf  
 blunt  
 roma  
 smusso

	L	DESCHAMPS	R
	27120-21	21 cm, 8 1/4"	27121-21
	27120-24	24 cm, 9 1/2"	27121-24
	27120-27	27 cm, 10 1/2"	27121-27



**MAST.SH-GERMANY**

Unterbindungsnadeln  
Ligature Needles  
Agujas para ligaduras  
Aghi per legature

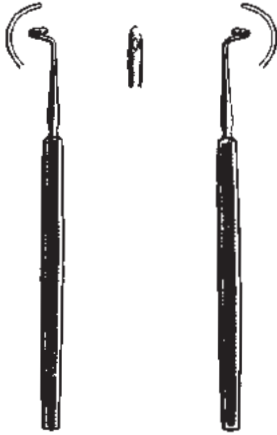

L KRONECKER R  
27130-13 27131-13  
13 cm, 5 1/8"

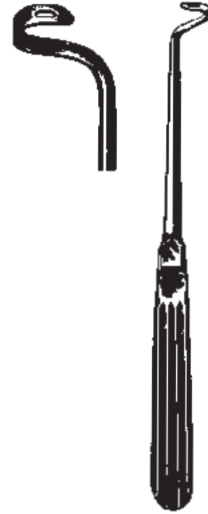

L NELSON R  
27133-24 27135-24  
24,5 cm, 9 3/4"



SCHMIEDEN-DICK  
27134-32 32 cm, 12 3/4"



COOPER  
27139-19 19 cm, 7 1/2"

Nahtinstrumente  
 Suturing Instruments  
 Instrumentos para suturas  
 Strumenti per suture

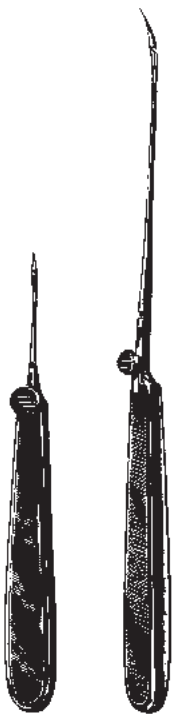

REVERDIN  
 27201-15 - 27204-21



Fig. 1

27201-15 15 cm, 6"  
 27201-19 19 cm, 7 1/2"  
 27201-21 21 cm, 8 1/4"



Fig. 2

27202-15 15 cm, 6"  
 27202-19 19 cm, 7 1/2"  
 27202-21 21 cm, 8 1/4"



Fig. 3

27203-15 15 cm, 6"  
 27203-19 19 cm, 7 1/2"  
 27203-21 21 cm, 8 1/4"



Fig. 4

27204-15 15 cm, 6"  
 27204-19 19 cm, 7 1/2"  
 27204-21 21 cm, 8 1/4"

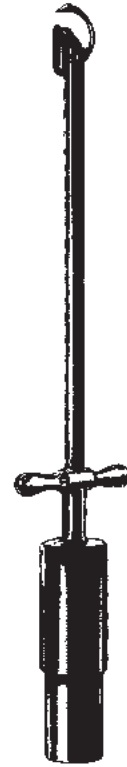

YOUNG BOOMERANG  
 27240-00  
 25 cm, 10"



Fig. 1  
 27240-01

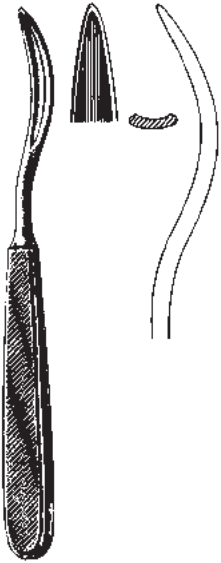

Fig. 2  
 27240-02

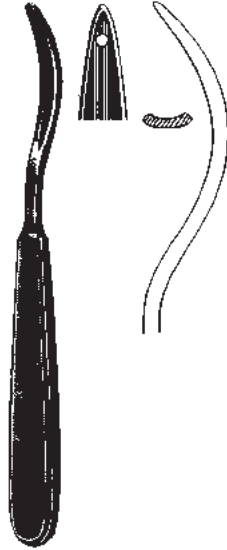

Fig. 3  
 27240-03

Führungshohlsonden  
 Ligature Conductors  
 Sondas conductoras  
 Sonde conduttrici



**SCHMIEDEN**  
 27271-19  
 19 cm, 7 1/2"



**SCHMIEDEN-PAYR**  
 27273-19  
 19 cm, 7 1/2"

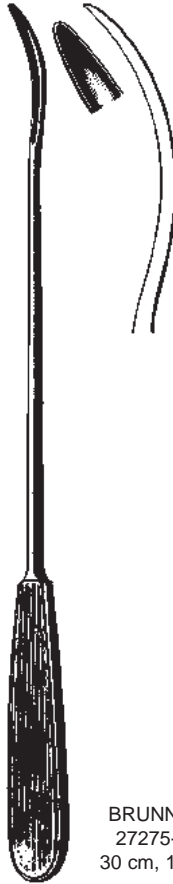

**BRUNNER**  
 27275-30  
 30 cm, 11 3/4"

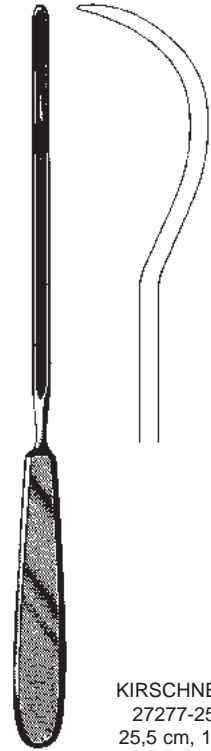

**KIRSCHNER**  
 27277-25  
 25,5 cm, 10"



**KOENIG**  
 27285-20  
 20 cm, 8"



**PAYR**  
 27288-22  
 22 cm, 8 3/4"



**PAYR**  
 27289-22  
 22 cm, 8 3/4"

Plastik  
 plastic  
 plástico



**BRUNNER**  
 27291-18 18 cm, 7"  
 27291-27 27 cm, 10 1/2"



**VIENNA**  
 27297-23  
 23,5 cm, 9 1/4"



**REDA**  
 27298-23  
 23 cm, 9"

Chirurgische Nadeln  
Suturing Needles  
Agujas para suturas  
Aghi per suture

Pack à 1 Dutzend  
in packages of 1 dozen  
en sobres de 1 docena  
confezione 1 dozzina

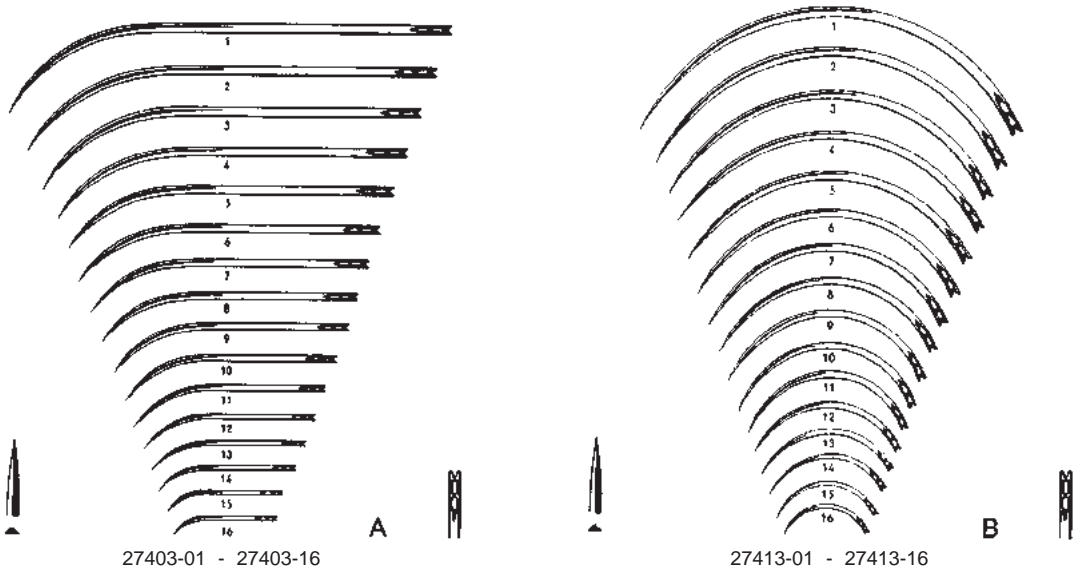
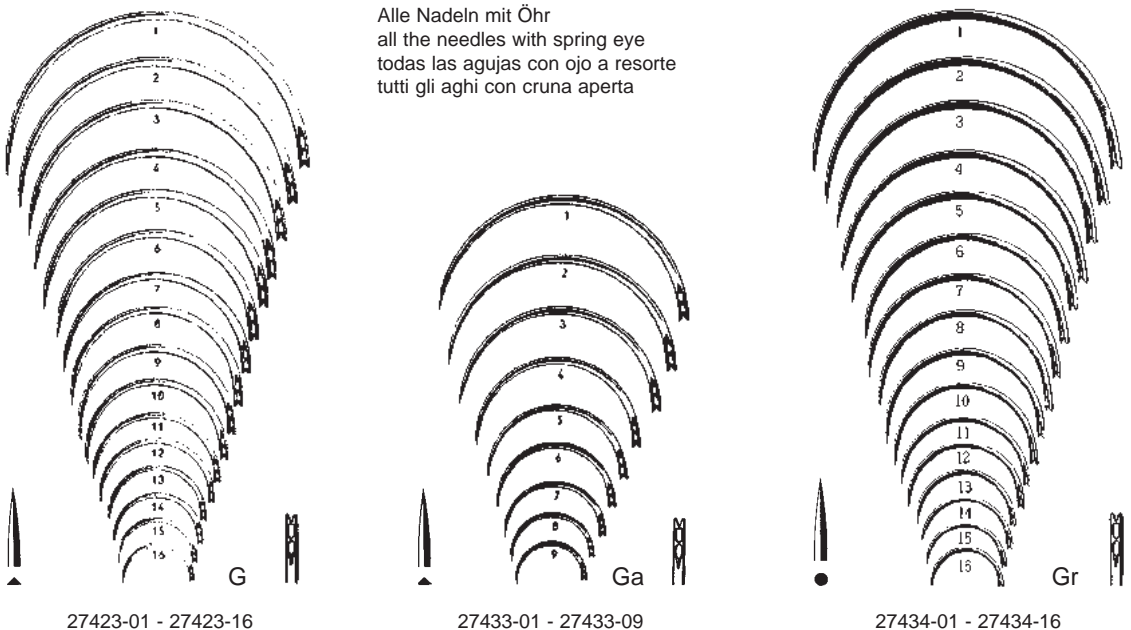

Fig. 1    2    3    4    5    6    7    8    9    10    11    12    13    14    15    16  
 A 27403-01 27403-02 27403-03 27403-04 27403-05 27403-06 27403-07 27403-08 27403-09 27403-10 27403-11 27403-12 27403-13 27403-14 27403-15 27403-16  
 B 27413-01 27413-02 27413-03 27413-04 27413-05 27413-06 27413-07 27413-08 27413-09 27413-10 27413-11 27413-12 27413-13 27413-14 27413-15 27413-16  
 G 27423-01 27423-02 27423-03 27423-04 27423-05 27423-06 27423-07 27423-08 27423-09  
 Ga 27433-01 27433-02 27433-03 27433-04 27433-05 27433-06 27433-07 27433-08 27433-09 27433-10 27433-11 27433-12 27433-13 27433-14 27433-15 27433-16  
 Gr 27434-01 27434-02 27434-03 27434-04 27434-05 27434-06 27434-07 27434-08 27434-09 27434-10 27434-11 27434-12 27434-13 27434-14 27434-15 27434-16



Chirurgische Nadeln  
Suturing Needles  
Agujas para suturas  
Aghi per suture

Alle Nadeln mit Öhr  
all the needles with spring eye  
todas las agujas con ojo a resorte  
tutti gli aghi con cruna aperta



27441-01 - 27441-12



KEITH  
27450-01 - 27450-06

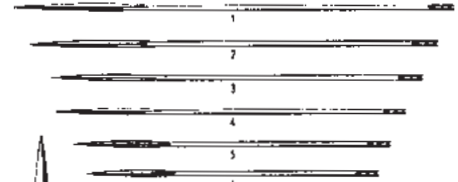

KEITH  
27452-01 - 27452-06

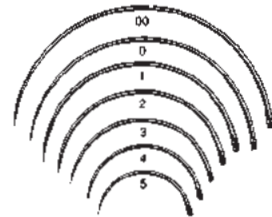

27465-20 - 27467-05 **Pb**

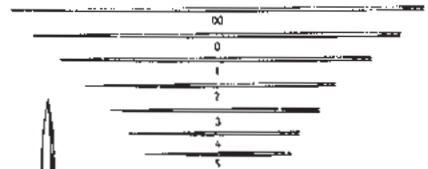

27475-20 - 27477-05 **Pc**

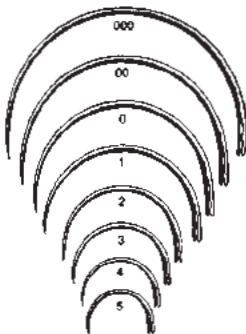

27443-30 - 27443-05

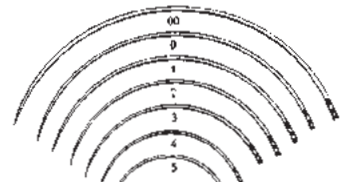

27485-20 - 27487-05 **Pd**

FIG.	000	00	0	1	2	3	4	5	6	7	8	9	10	11	12
KÖNIG				27441-01	27441-02	27441-03	27441-04	27441-05	27441-06	27441-07	27441-08	27441-09	27441-10	27441-11	27441-12
E	27443-30	27443-20	27443-10	27443-01	27443-02	27443-03	27443-04	27443-05							
KEITH				27450-01	27450-02	27450-03	27450-04	27450-05	27450-06						
KEITH					27452-01	27452-02	27452-03	27452-04	27452-05	27452-06					
Pb		27465-20	27465-10	27467-01	27467-02	27467-03	27467-04	27467-05							
Pc		27475-20	27475-10	27477-01	27477-02	27477-03	27477-04	27477-05							
Pd		27485-20	27485-10	27487-01	27487-02	27487-03	27487-04	27487-05							

Nahtinstrumente und Wundklammern  
 Clips and Instruments  
 Agrafes e instrumentos  
 Agrafes e strumenti

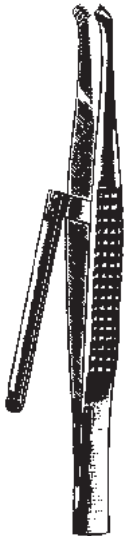

CHILDE  
 27620-18  
 18 cm, 7"



MICHEL  
 27610-12  
 12 cm, 4 3/4"



WACHENFELDT  
 27612-12  
 12,5 cm, 5"



WACHENFELDT  
 27614-12  
 12,5 cm, 5"



HEGENBARTH  
 27616-12  
 12,5 cm, 5"



MICHEL  
 27630-12  
 12 cm, 4 3/4"



COLLIN  
 27640-13  
 13 cm, 5 1/8"

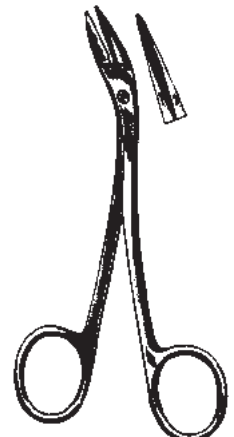

RICHTER-HEATH  
 27642-14  
 14 cm, 5 1/2"



MICHEL

- MICHEL mm  
 27660-07 7,5x1,75  
 27660-11 11x2  
 27660-12 12x3  
 27660-14 14x3  
 27660-16 16x3  
 27660-18 18x3  
 27660-20 20x3  
 27660-22 22x3

Pack à 1000  
 box of 1000  
 paq x 1000  
 confezione x 1000



Taschenbestecke  
Pocket, Suturing Kits  
Estuche de bolsillo y de sutura  
Astucci tascabili e per sutura



27670-00  
130 x 45 x 18 mm

Wundnahtbesteck in Metall-Etui,  
bestehend aus:  
Michel Wundklammerzängchen  
Wachenfeldt Faßpinzette  
50 Michel Wundklammern

Estuche para sutura, en caja de metal,  
compuesto de:  
Pinza para agrafes de Michel  
Pinza para juntar los bordes de la herida,  
de Wachenfeldt, con porta-agrafas  
50 Agrafes (Grapas) de Michel

Suture Clip set in metal case,  
consisting of:  
Suture Clip Forceps Michel  
Approximation Forceps, Wachenfeldt,  
with clip rack  
50 suture clips Michel

Set di clip per suture in astuccio di metallo  
composto da:  
Pinza di Michel per clip  
Pinza Wachenfeldt con fermagli per sutura  
50 Agrafes di Michel



# MAST.SH-GERMANY

Taschenbestecke  
Pocket, Suturing Kits  
Estuche de bolsillo y de sutura  
Astucci tascabili e per sutura



STANDARD

27680-00  
165 x 90 x 28 mm

Komplett in Metalltui und Plastiktasche mit 2 herausnehmbaren gelochten Einlagen mit Stegen für Instrumente

Bestehend aus:

- 1 Mathieu Nadelhalter 14 cm (5 $\frac{1}{2}$ " )
- 1 Nähseide in Alkohol
- 6 Nähnadeln sortiert
- 1 Nadeldose gelocht 65 x 42 cm
- 1 Michel Wundklammerzange
- 20 Wundklammern auf Halter
- 1 Skalpellgriff mit Klinge
- 3 Klängen auswechselbar
- 1 Schere st/sp. 13 cm (5") gerade
- 1 anat. Pinzette 11,5 cm (4 $\frac{1}{2}$ " )
- 1 Hakenpinzette 1 x 2 Z. 12 cm (4 $\frac{3}{4}$ " )
- 1 Hunter Splitterpinzette 10,5 cm (4 $\frac{1}{4}$ " )
- 1 Kocher Arterienklemme 13 cm (5")
- 1 Myrtenblattsonde 13 cm (5")

Complete in metal case with plastic pouch and 2 removable perforated trays for instruments

Contents:

- 1 Mathieu Needle Holder, 14 cm (5 $\frac{1}{2}$ " )
- 1 Flacon with sterilized silk in alcohol
- 6 Suture Needles, assorted
- 1 Needle Case, 25.6" x 16.5", perforated
- 1 Michel Suture Clip Forceps
- 20 Michel Suture Clips with Clip Holder
- 1 Scalpel Handle with Blade
- 3 Scalpel Blades, interchangeable
- 1 Scissors, straight, blunt/sharp, 13 cm (5")
- 1 Dressing Forceps, 11,5 cm (4 $\frac{1}{2}$ " )
- 1 Tissue Forceps, 12 cm (4 $\frac{3}{4}$ " ), 1 x 2 teeth
- 1 Hunter Splitter Forceps, 10,5 cm (4 $\frac{1}{4}$ " )
- 1 Kocher Artery Forceps, straight, 13 cm (5"), S
- 1 Probe with myrtle leaf, 13 cm (5")

Completo en caja de metal con bolsa de plástico y 2 bandejas perforadas para los instrumentos

Contenido:

- 1 Porta-aguja de Mathieu, 14 cm (5 $\frac{1}{2}$ " )
- 1 Frasco con seda esterilizada para sutura, en alcohol
- 6 Agujas de sutura surtidas
- 1 Cajita para agujas, 65 x 42 mm, perforada
- 1 Pinza para agrafes de Michel
- 20 Agrafes de Michel, en su porta-agrafes
- 1 Mango de bisturi, con hoja intercambiable
- 3 Hojas intercambiables surtidas
- 1 Tijera, recta, roma/aguda, 13 cm (5")
- 1 Pinza de disección, 11,5 cm (4 $\frac{1}{2}$ " )
- 1 Pinza de disección, con 1 x 2 dientes, 12 cm (4 $\frac{3}{4}$ " )
- 1 Pinza para espinas de Hunter, 10,5 cm (4 $\frac{1}{4}$ " )
- 1 Pinza hemostática de Kocher, 13 cm (5"), S.
- 1 Estilete abotonado, multiforme, 13 cm (5")

Astuccio tascabile con due supporti estraibili

Contenente:

- 1 Port aghi di Mathieu 14 cm (5 $\frac{1}{2}$ " )
- 1 Set per sutura in flacone di vetro
- 6 aghi per sutura assortiti
- 1 scatola per aghi 65 x 24 perforata
- 1 pinza per sutura di Michel
- 20 Agrafe Michel ed porta agrafe
- 1 Manico da bisturi per lama intercambiabile
- 3 lame da bisturi intercambiabili
- 1 forbici rette alterne 13 cm (5")
- 1 pinze da dissezione
- 1 pinze da dissezione 1 x 2 denti
- 1 pinze di Hunter per schegge 10,5 cm (4 $\frac{1}{4}$ " )
- 1 pinze emostatiche di Kocher 13 cm (5")
- 1 specillo bottonuto 13 cm (5")

Sterilisierzangen, Abfallzange, Sterilisierklammern  
 Sterilization Instruments, Waste Forceps, Safety pins  
 Instrumentos para la esterilización, Pinza para desechos, Cadres de estérilización,  
 Pinze per la sterilizzazione, Pinza per rifiuti, Spilloni p. sterilizzazione



**DAVIS**  
 29102-16 16 cm, 6 1/4"  
 29102-20 20 cm, 8"  
 29102-24 24 cm, 9 1/2"

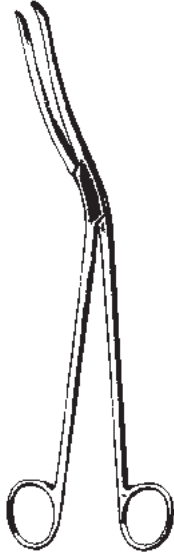

**CHEATTLE**  
 29110-27  
 27 cm, 10 1/2"

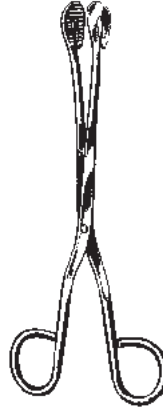

**UNIVERSAL**  
 29120-20 20 cm, 8" 29121-20  
 29120-28 28 cm, 11" 29121-28

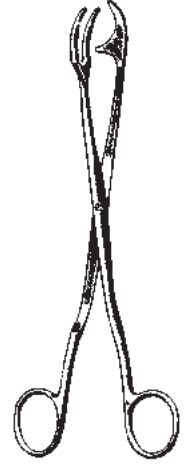

**ROGGE**  
 29130-23  
 23 cm, 9"



29140-20 20 cm, 8"  
 29140-30 30 cm, 11 3/4"



**BUNT**  
 29150-12 12 cm, 4 3/4"



**MAYO**  
 29152-14 14 cm, 5 1/2"

**SAUERBRUCH**  
 29145-55  
 55 cm, 21.7"

Gipsscheren  
 Plaster of Paris Shears  
 Cizallas para vendajes enyesados  
 Cesioie per gessi



STILLE  
 31101-24 24 cm, 9 1/2"

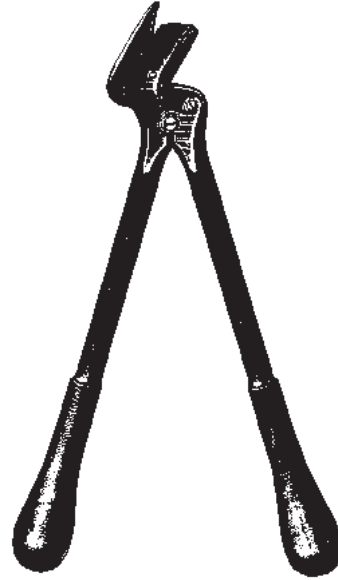

STILLE  
 31103-23 23 cm, 9"  
 31103-26 26 cm, 10 1/4"  
 31103-37 37 cm, 14 1/2"



Gipsmesser  
 plaster knife  
 cuchillo para vendajes enyesados  
 coltello da gesso

WIGMORE  
 31120-19 19 cm, 7 1/2"

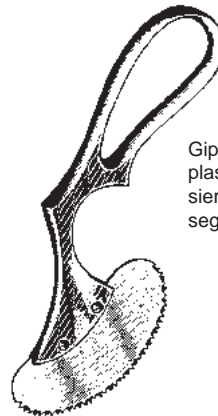

Gipssäge  
 plaster saw  
 sierra para vendajes enyesados  
 sega da gesso

ENGEL  
 31130-14  
 verchromt

Oscillierende Gipssäge  
 Oscillating Plaster Saw  
 Sierra oscilante p. vendajes enyesados  
 Sega oscillante per gessi

Elektrische Gipssäge  
 Electric Plaster Cast Cutter  
 Sierra eléctrica para yesos  
 Sega elettrica per gessi



31210-21 110 Volt, compl. of Art.-Nr. 31212-02/31210-50/31210-65  
 31210-22 230 Volt, compl. of Art.-Nr. 31212-02/31210-50/31210-65

Geräuschpegel min. 63 max. 69 DB  
 Noise level machine only: Min. 63 Max. 69 db/(A)  
 Nivel de ruido del aparato sólo 63 dB (mín.), 69 dB/(A)  
 Livello acustico dello strumento solo: min. 63 max. 69 db/(A)

EN 60601-1, EN 60601-1-2, IEC 60601-1, IEC 60601-1-2

31212-02  
 Schlüsselpaar  
 pair of screw driver  
 par le Llave  
 paio di chiavi

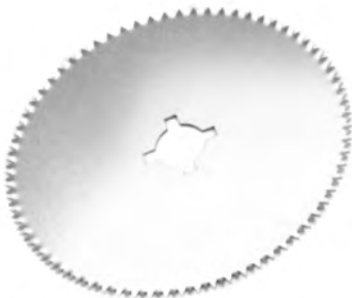

31210-50	50 mm (2.0") Ø	weich *
31210-65	65 mm (2.6") Ø	weich *
31211-50	50 mm (2.0") Ø	hart *
31211-65	65 mm (2.6") Ø	hart *

- \* Ersatz-Sägeblätter, spezialgehärtet (F. Fiberglas u. andere Hartverbände)
- \* Spare saw blades, special hardness (for dressing of fiber glass for other hard dressing)
- \* Hojas de repuesto, templadas especialmente (para vendajes de fibra de vidrio y otros vendajes duros)
- \* Lame per sega a tempera speciale per bendaggi (in fibro di vetro ed altri bendaggi duri)

Autopsiesäge  
Autopsy saw  
Sierra para autopsia  
Sega per autopsia

Schnellspannfutter  
Quick-action chuck  
tuerca de fijación rapida  
Mandrino rapido

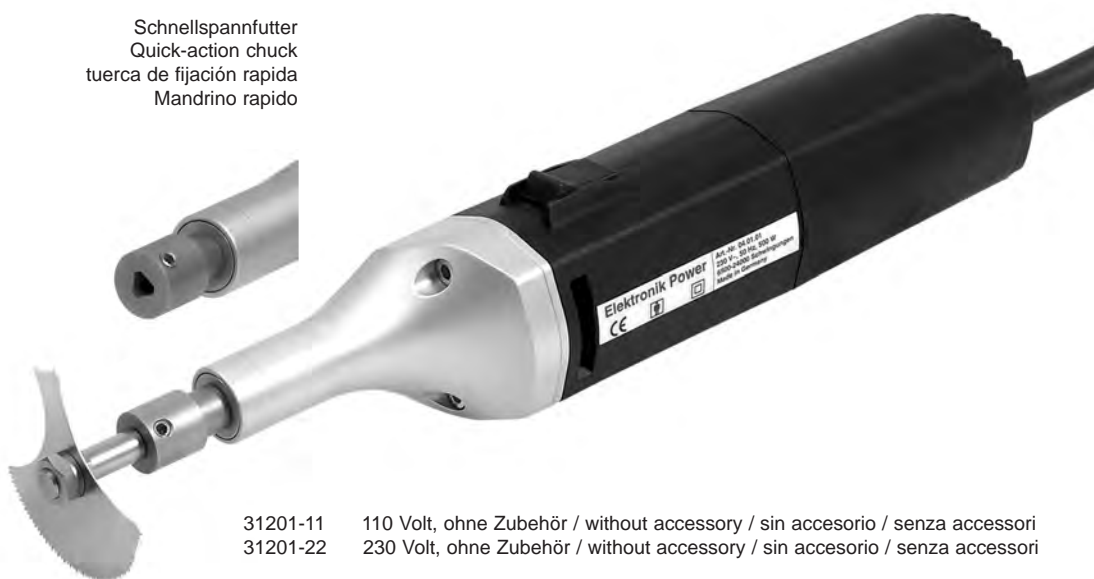

31201-11 110 Volt, ohne Zubehör / without accessory / sin accesorio / senza accessori  
31201-22 230 Volt, ohne Zubehör / without accessory / sin accesorio / senza accessori

Geräuschpegel min. 63 max. 69 DB  
Noise level machine only: Min. 63 Max. 69 db/(A)  
Nivel de ruido del aparato sólo 63 dB (mín.), 69 dB/(A)  
Livello acustico dello strumento solo: min. 63 max. 69 db/(A)

EN 60601-1, EN 60601-1-2, IEC 60601-1, IEC 60601-1-2



# MAST.SH-GERMANY

Zubehör zur Autopsiesäge  
Accessories for Autopsy saw  
Accesorio para la sierra de autopsia  
Accessori per sega per autopsia



### Segmentssäge

besteht aus:  
1 x 31204-01 Segment-Sägeblatt  
1 x 31201-39 Schaft 39 mm

### Segment saw

consisting of:  
1 x 31204-01 segment saw  
1 x 31201-39 arbor 39 mm

### Sierra para segmento

compuesto de:  
1 x 31204-01 hoja de sierra  
1 x 31201-39 vastago 39 mm

### Sega a segmento

composta da:  
1 x 31204-01 Lama a segmento  
1 x 31201-39 Asta 39 mm



### Tiefensäge

besteht aus:  
1 x 31205-20 Tiefen-Sägeblatt, 20 mm  
1 x 31201-39 Schaft 39 mm

### Deep cutting saw

consisting of:  
1 x 31205-20 deep cutting saw, 20 mm  
1 x 31201-39 arbor 39 mm

### Sierra de profundidad

compuesto de:  
1 x 31205-20 hoja de sierra, 20 mm  
1 x 31201-39 vastago 39 mm

### Sega a taglio di profondità

composta da:  
1 x 31205-20 Lama a taglio di profondità, 20 mm  
1 x 31201-39 Asta 39 mm



### Tiefensäge schmal

besteht aus:  
1 x 31205-08 Tiefen-Sägeblatt, 8 mm  
1 x 31201-39 Schaft 39 mm

### Deep cutting saw narrow

consisting of:  
1 x 31205-08 deep cutting saw, 8 mm  
1 x 31201-39 arbor 39 mm

### Sierra de profundiad, estrecha

compuesto de:  
1 x 31205-08 hoja de sierra, 8 mm  
1 x 31201-39 vastago 39 mm

### Sega a taglio sottile di profondità

composta da:  
1 x 31205-08 Lama a taglio di profondità, 8 mm  
1 x 31201-39 Asta 39 mm



### Kreissäge ø 65 mm

mit exzentrischer Begrenzungsscheibe für differenzierte Schnitt-Tiefe von 4 bis 11 mm,  
besteht aus:  
1 x 31210-65 Sägeblatt ø 65 mm  
1 x 31203-50 Begrenzungsscheibe  
1 x 31201-39 Schaft 39 mm

### Circular saw ø 65 mm

with eccentric disk to limit depth of cut from 4 - 11 mm  
consisting of:  
1 x 31210-65 circular saw ø 65 mm  
1 x 31203-50 limiting disc  
1 x 31201-39 arbor 39 mm

### Sierra circular ø 65 mm

con disco de tope excentrico para diferentes cortes de profundidad de 4 mm hasta 11 mm  
compuesto de:  
1 x 31210-65 hoja de sierra, ø 65 mm  
1 x 31203-50 disco de tope  
1 x 31201-39 vastago 39 mm

### Sega circolare diam. 65 mm

con disco di limitazione eccentrico per taglio differenziato dal 4 mm al 11 mm,  
composta da:  
1 x 31210-65 Lama circolare, ø 65 mm  
1 x 31203-50 Disco eccentrico  
1 x 31201-39 Asta 39 mm



## MAST.SH-GERMANY

Zubehör zur Autopsiesäge  
Accessories for Autopsy saw  
Accesorio para la sierra de autopsia  
Accessori per sega per autopsia



31201-39  
Schaft, 39 mm lang  
arbor, 39 mm  
vastago, 39 mm de largo  
asta, lunghezza 39 mm



31201-58  
Schaft, 58 mm lang  
arbor, 58 mm  
vastago, 58 mm de largo  
asta, lunghezza 58 mm



31202-16  
Imbusschlüssel mit T-Griff zum Befestigen des Bohrfutters  
Alan key wit T-handle  
Llave hexagonal con mango de T para fijacion del taladro  
Chiave esagonale con manico a T per fissaggio del mandrino



31212-02  
Schlüsselpaar zum Auswechseln der Sägeblätter  
pair of screw driver  
par de llave para cambiar las hojas de sierra  
Paio di chiavi per cambio delle lame



Gipsspreizer, Gipsabreißzangen  
 Plaster Cast Instruments  
 Instrumentos para vendajes enyesados  
 Allargagessi, Strappagessi

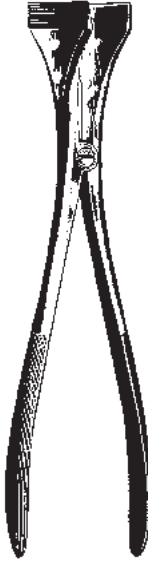

**HENNIG**  
 31350-28 28 cm, 11"

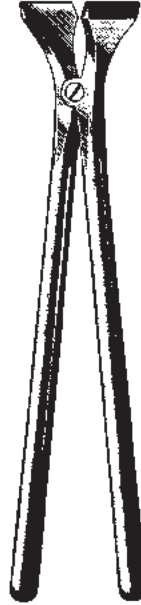

**BEESON**  
 31360-30 30 cm, 11 3/4"

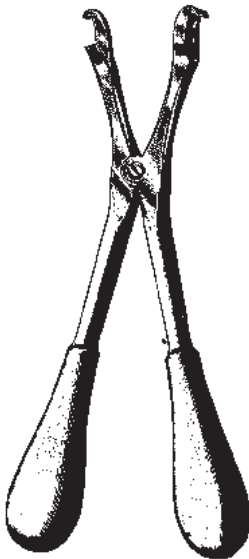

**HAGLUND-STILLE**  
 31362-28 28 cm, 11"



**REDA**  
 31366-23 23 cm, 9"

Gipsspreizer, Gipsmesser, Gipsabreißzangen  
Plaster Cast Instruments, Knives  
Instrumentos para vendajes enyesados, Cuchillos  
Allargagessi, Coltelli per Gessi, Strappagessi



HOPKINS  
31370-20  
20 cm, 8"



ESMARCH  
31380-18  
18 cm, 7"



REINER  
31390-18  
18 cm, 7"



WOLFF  
31395-18  
18 cm, 7"



WOLFF  
31397-24  
24 cm, 9 1/2"

Hohlmeißelzangen  
 Bone Rongeurs  
 Pinzas-gubias  
 Pinze sgorbie

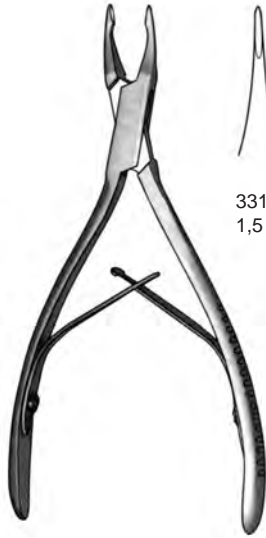

33100-01  
 1,5 x 5 mm



33100-02  
 1,5 x 5 mm

**MICRO FRIEDMAN**  
 33100-02 14 cm, 5 1/2"

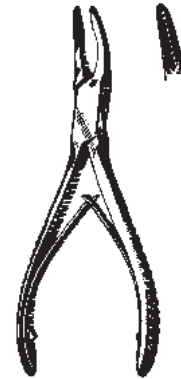

**FRIEDMAN Mini**  
 33101-12 12 cm, 4 3/4"

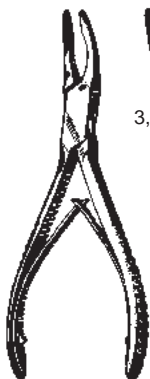

3,5 mm

**FRIEDMAN**  
 33101-14 14 cm, 5 1/2"



33102-01  
 2 mm



33102-02  
 2 mm

**STELLBRINK**  
 33102-02 17 cm, 6 3/4"

Hohlmeißelzangen  
 Bone Rongeurs  
 Pinzas-gubias  
 Pinze sgorbie

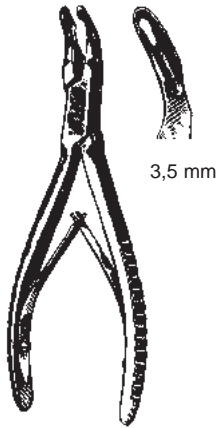

CLEVELAND  
 33103-14 14 cm, 5 1/2"

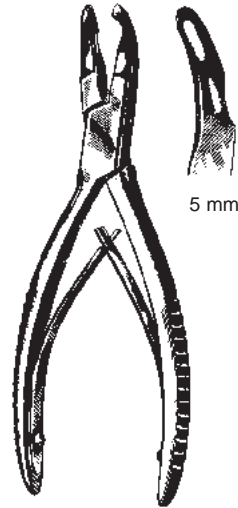

CLEVELAND  
 33105-17 17 cm, 6 3/4"

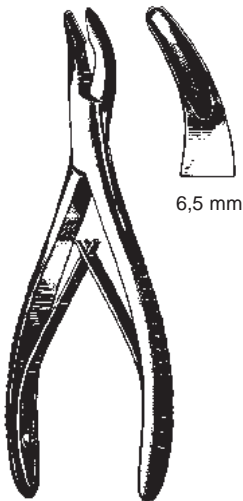

MEAD  
 33107-16 16,5 cm, 6 1/2"

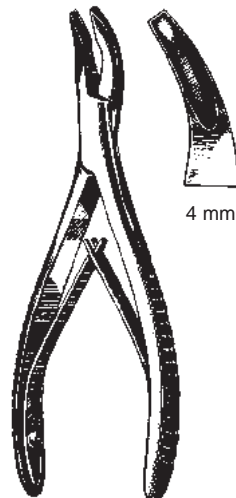

MEAD33109-16 16,5 cm, 6 1/2"



Hohlmeißelzangen  
Bone Rongeurs  
Pinzas-gubias  
Pinze sgorbie

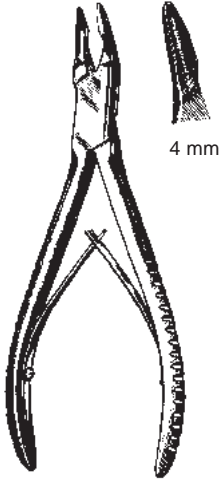

4 mm

BLUMENTHAL  
33115-15  
15,5 cm, 6"

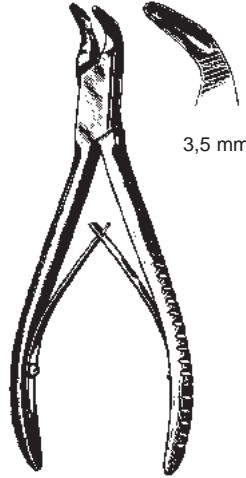

3,5 mm

BLUMENTHAL  
33117-15  
15,5 cm, 6"

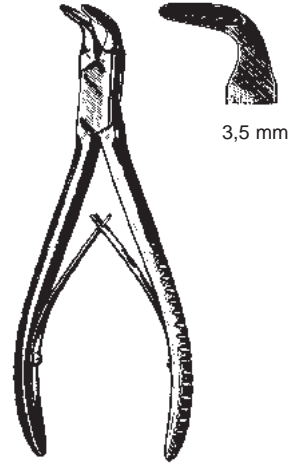

3,5 mm

BLUMENTHAL  
33119-15  
15,5 cm, 6"

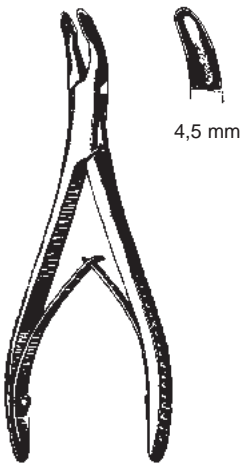

4,5 mm

LUER  
33131-15  
15 cm, 5.9"

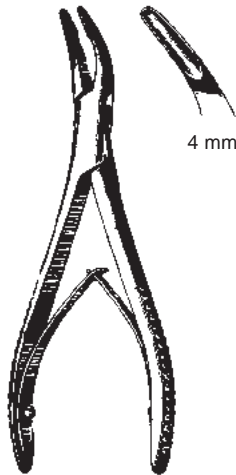

4 mm

LUER  
33133-15  
15 cm, 5.9"



8 mm

LUER  
33136-17 33137-17  
17 cm, 6 3/4"



9 mm

ADSON  
33142-20 33143-20  
20 cm, 7.9"

Hohlmeißelzangen  
 Bone Rongeurs  
 Pinzas-gubias  
 Pinze sgorbie

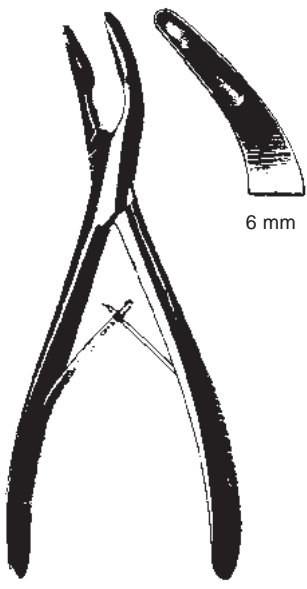

**OLIVECRONA**  
 33147-20  
 20 cm, 7.9"



**BANE-HARTMANN**  
 33148-18  
 17,5 cm, 7"



**LEMPERT**  
 33150-16 33151-16  
 16 cm, 6 1/4"



**JANSEN**  
 17 cm, 6 3/4"



**LEMPERT**  
 33154-18 33155-18  
 18,5 cm, 7 1/4"



**BEYER**  
 33156-18  
 18 cm, 7"

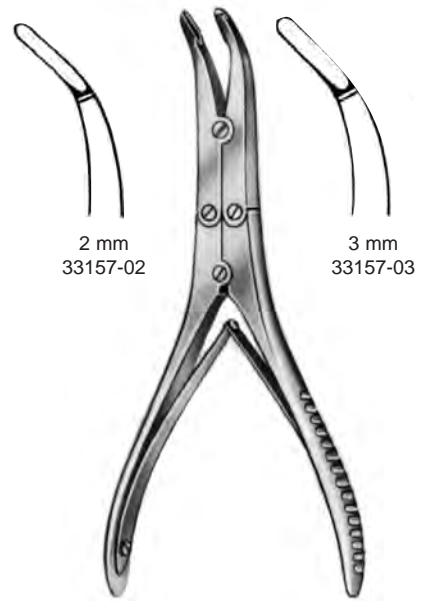

**KLEINERT-KUTZ**  
 15 cm, 6"

Hohlmeißelzangen  
 Bone Rongeurs  
 Pinzas-gubias  
 Pinze sgorbie

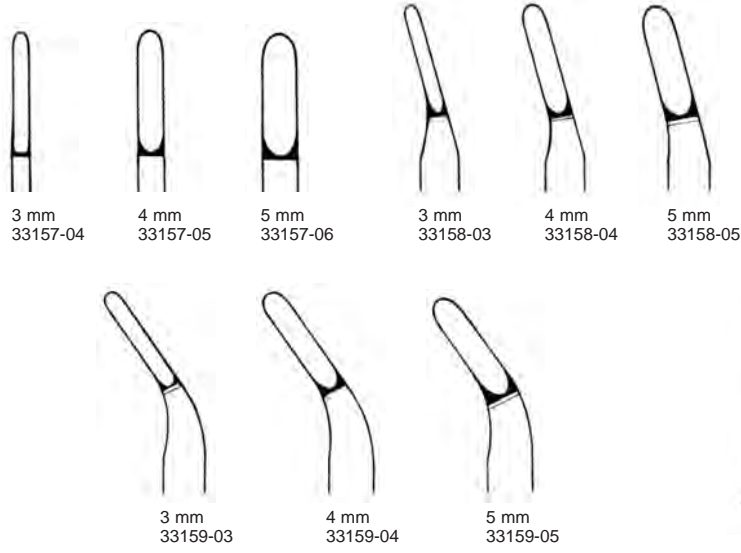

**SMITH-PETERSEN**  
 24 cm, 9 1/2"

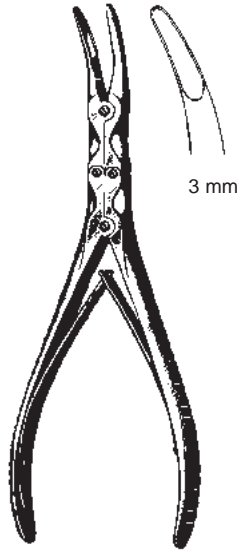

**BEYER**  
 33201-18  
 18 cm, 7"



**MAYFIELD**  
 33202-18  
 18 cm, 7"

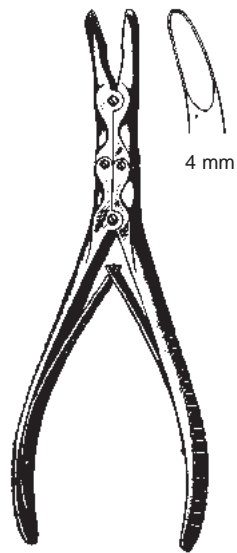

**ZAUFAL-JANSEN**  
 33205-18  
 18 cm, 7"



**BÖHLER**  
 33211-15    33213-15  
 15 cm, 6"

Hohlmeißelzangen  
 Bone Rongeurs  
 Pinzas-gubias  
 Pinze sgorbie

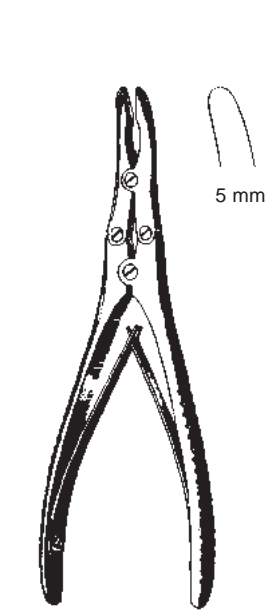

**RUSKIN**  
 33216-18 33217-18  
 18 cm, 7"

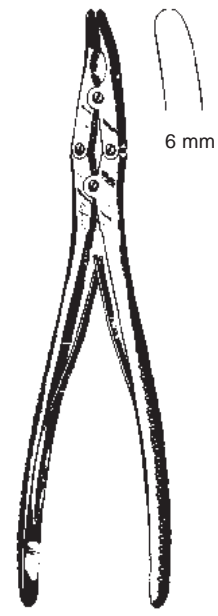

**RUSKIN**  
 33219-23 23 cm, 9"



**MARQUARDT**  
 33220-20 20 cm, 8"

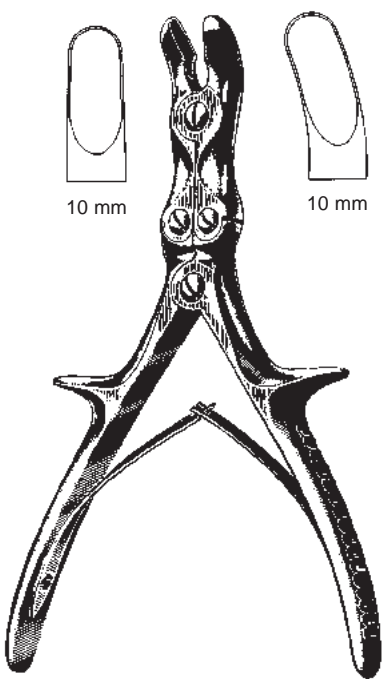

**STILLE-LUER**  
 33230-22 22 cm, 8 3/4" 33231-22  
 33230-26 26 cm, 10 1/4" 33231-26

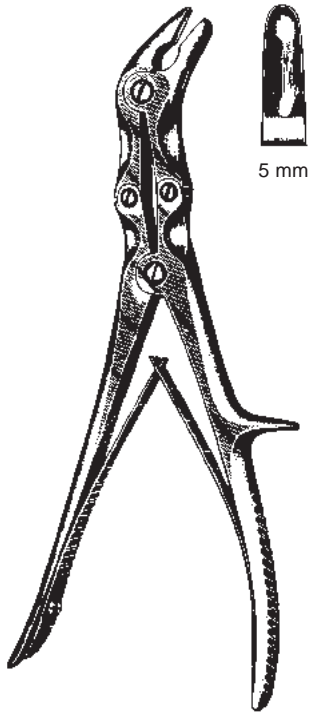

**STILLE-LUER**  
 33235-23  
 23 cm, 9"

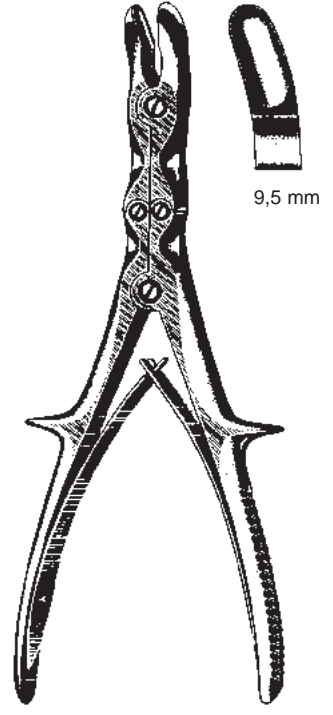

**STILLE-RUSKIN**  
 33237-23  
 23 cm, 9"



Hohlmeißelzangen  
 Bone Rongeurs  
 Pinzas-gubias  
 Pinze sgorbie

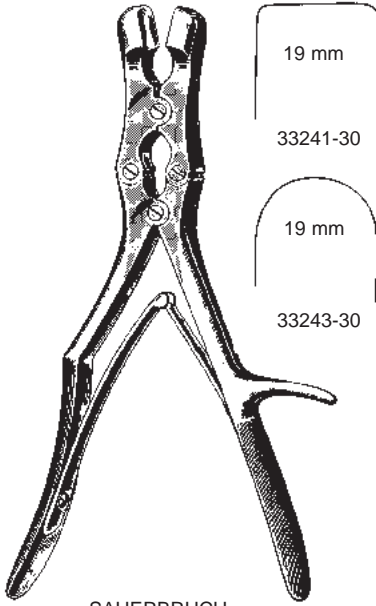

**SAUERBRUCH**  
 30 cm, 10 3/4"

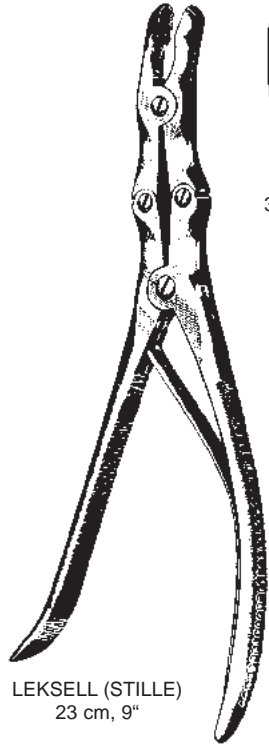

**LEKSELL (STILLE)**  
 23 cm, 9"

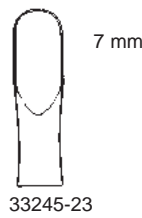

33245-23

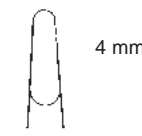

33247-23

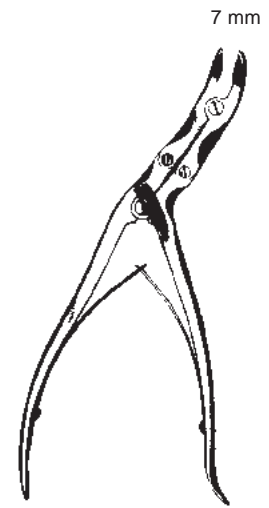

**R**  
 33251-26  
 rechts  
 right  
 derecha  
 a destra

**SCAGLIETTI**  
 26 cm, 10 1/4"

**L**  
 33253-26  
 links  
 left  
 izquierda  
 a sinistra



**ECHLIN**  
 33257-23 2 mm  
 33258-23 4 mm  
 33259-23 3 mm  
 23 cm, 9"



**FRYKHOLM**  
 33260-24  
 24 cm, 9 1/2"

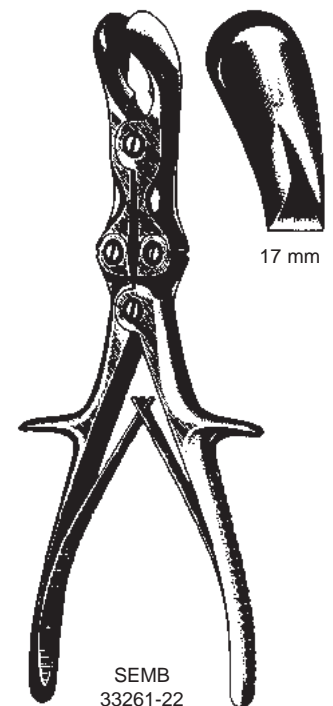

**SEMB**  
 33261-22  
 22,5 cm, 8.9"

17 mm

Knochensplitterzangen  
 Bone Cutting Forceps  
 Pinzas cortantes para huesos  
 Cesioie per ossa

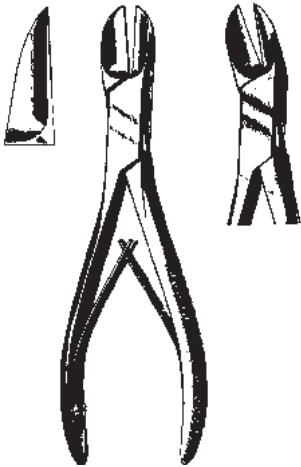

LISTON

- |          |               |          |
|----------|---------------|----------|
| 33274-14 | 14 cm, 5 1/2" | 33275-14 |
| 33274-17 | 17 cm, 6 3/4" | 33275-17 |
| 33274-19 | 19 cm, 7 1/2" | 33275-19 |
| 33274-22 | 22 cm, 8 3/4" | 33275-22 |



BÖHLER

- |           |          |
|-----------|----------|
| 33280-15  | 33281-15 |
| 15 cm, 6" |          |



COTTLE-KAZANJIAN

- |               |
|---------------|
| 33282-19      |
| 19 cm, 7 1/2" |



MC INDOE  
 33283-17  
 17 cm, 6 3/4"



STAMM  
 33284-15  
 15 cm, 6"

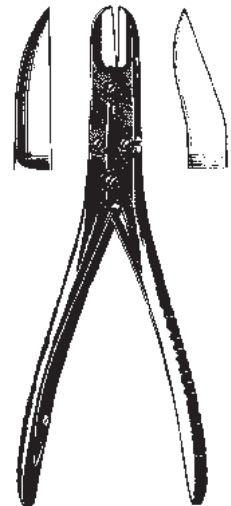

RUSKIN-LISTON

- |          |          |           |
|----------|----------|-----------|
| 33286-18 | 33289-18 | 18 cm, 7" |
|----------|----------|-----------|

Knochensplitterzangen  
 Bone Cutting Forceps  
 Pinzas cortantes para huesos  
 Cesoi e per ossa

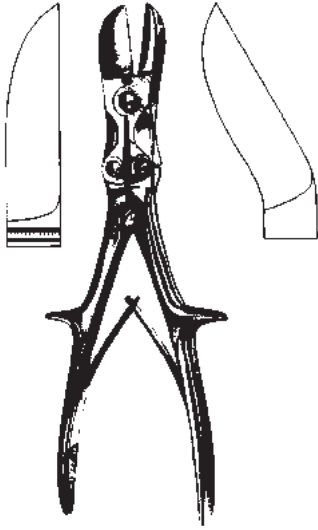

— STILLE-LISTON —  
 33290-23 23 cm, 9" 33291-23  
 33290-27 27 cm, 10 1/2" 33291-27



STILLE-LISTON  
 33292-26  
 26 cm, 10 1/4"

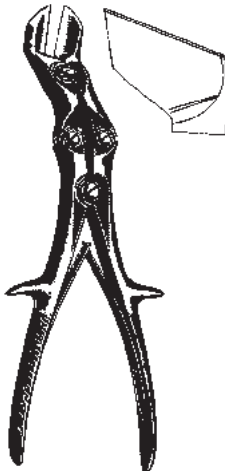

STILLE-HORSLEY  
 33293-27 27  
 cm, 10 1/2"



SEMB  
 33295-24  
 24 cm, 9 1/2"

Knochenhalte­zangen  
 Bone Holding Forceps  
 Pinzas para huesos  
 Tenaglie per ossa

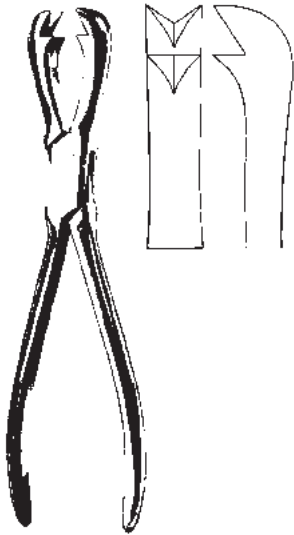

**FERGUSSON**  
 33360-21  
 21 cm, 8 1/4"

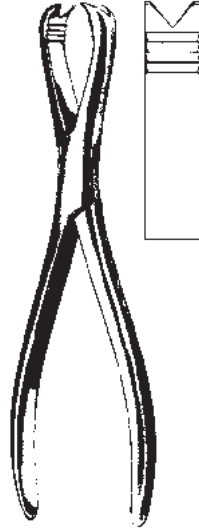

**LANGENBECK**  
 33362-21  
 21 cm, 8 1/4"

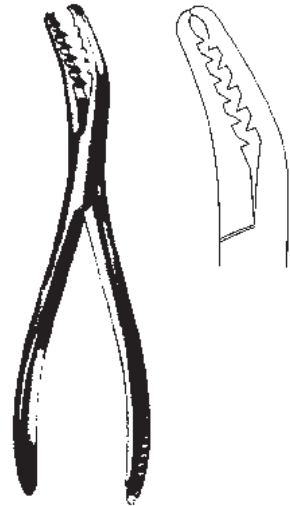

**SEMB**  
 33365-19 19 cm, 7 1/2"



**SEMB**  
 33366-19 20 cm, 8"  
 mit Sperre



**FARABEUF**  
 33366-23 23 cm, 9"  
 33366-26 26 cm, 10 1/4"



**FARABEUF-LAMBOTTE**  
 33368-26 26 cm, 10 1/4"

Knochenhalte­zangen  
 Bone Holding Forceps  
 Pinzas para huesos  
 Tenaglie per ossa

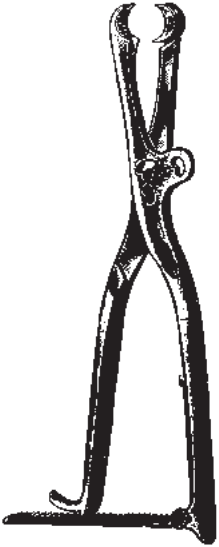

LAMBOTTE

33370-22 22 cm, 8 3/4"  
 33370-27 27 cm, 10 1/2"  
 33370-30 30 cm, 11 3/4"

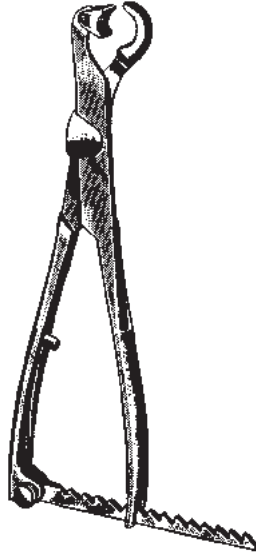

LAMBOTTE

33372-22 22 cm, 8 3/4"  
 33372-26 26 cm, 10 1/4"  
 33372-33 33 cm, 13"

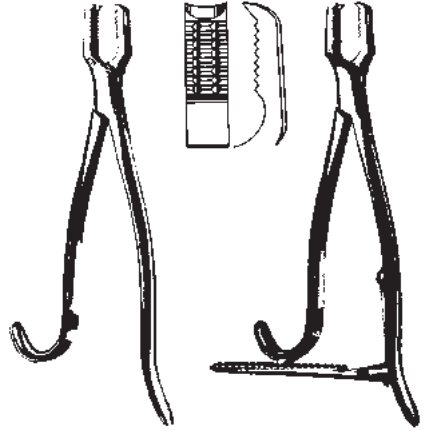

KERN

33378-15 15 cm, 6" 33380-15  
 33378-17 17 cm, 6 3/4" 33380-17  
 33378-21 21 cm, 8 1/4" 33380-21

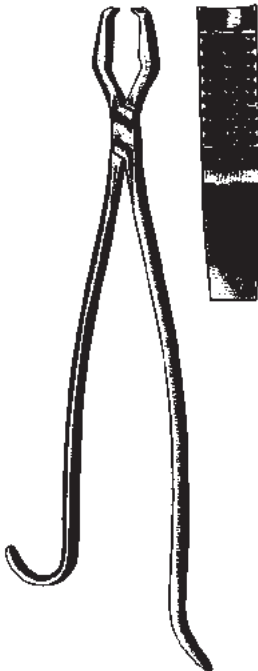

LANE33382-33 33 cm, 13"  
 33382-45 45 cm, 17"

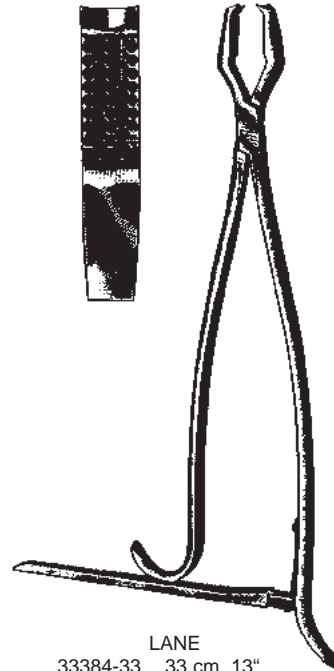

LANE

33384-33 33 cm, 13"  
 33384-45 45 cm, 17 3/4"

Knochenhaltezangen  
 Bone Holding Forceps  
 Pinzas para huesos  
 Tenaglie per ossa

selbstzentrierend  
 self-centering  
 autocentrantes  
 autocentranti

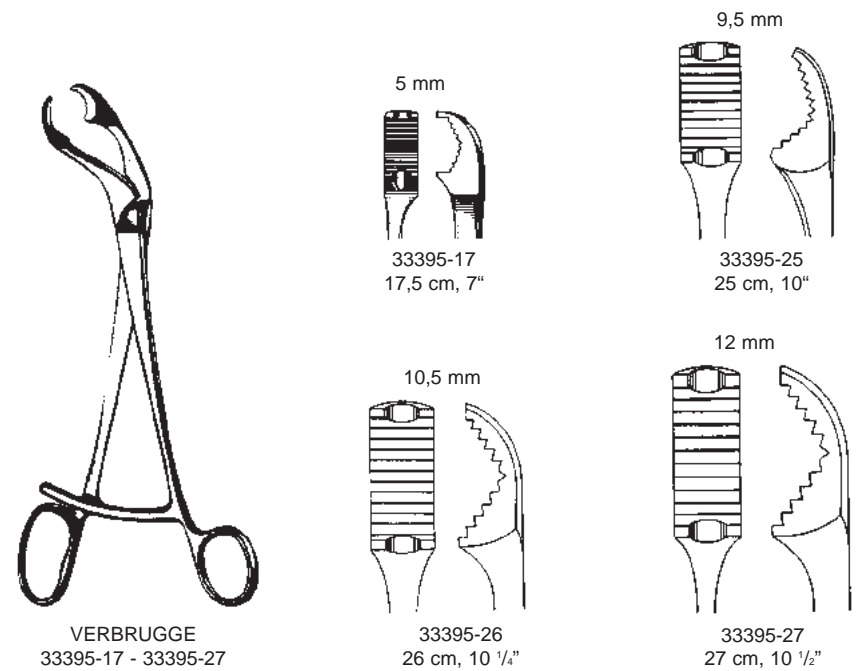
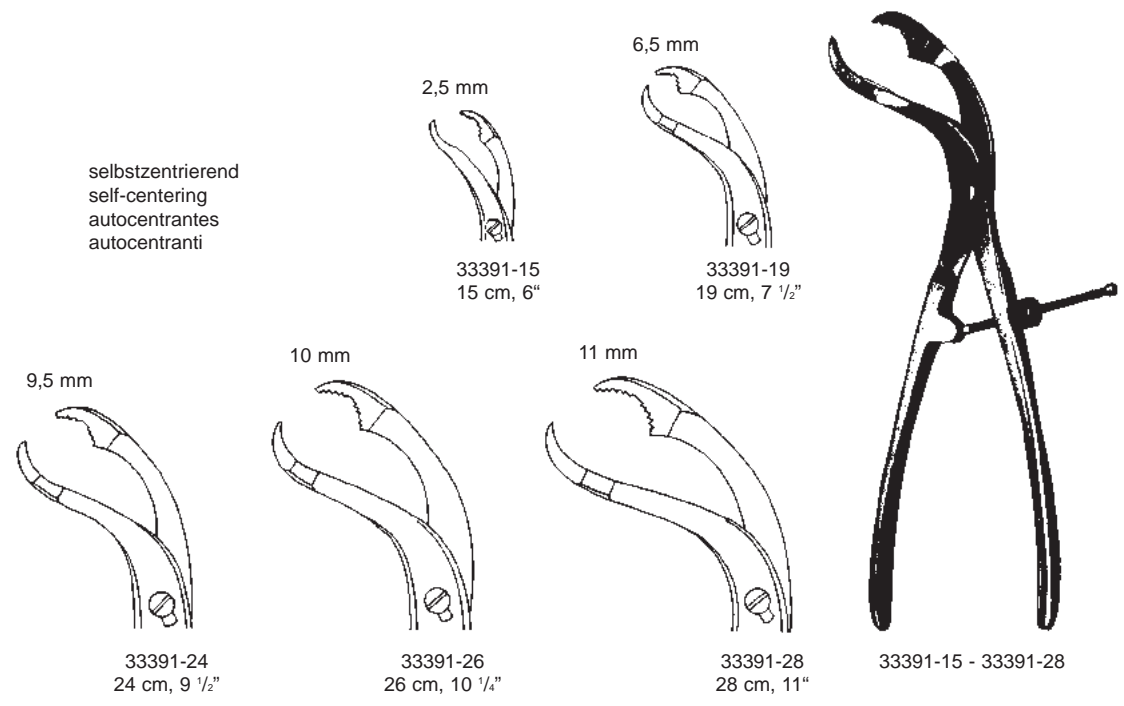

Knochenhalte­zangen  
 Bone Holding Forceps  
 Pinzas para huesos  
 Tenaglie per ossa

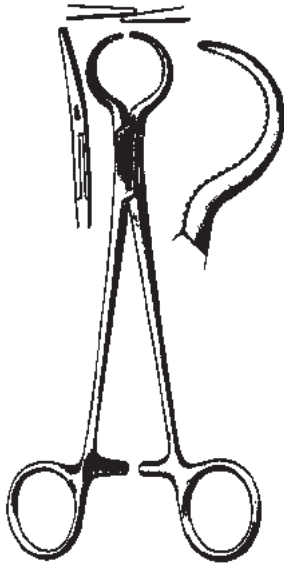

LEWIN  
 33402-17  
 17,5 cm, 7"



BIRCHER-GANSKE  
 33404-20 33405-20  
 20 cm, 8"



33406-20  
 20 cm, 8"



DINGMANN  
 33407-19  
 19 cm, 7 1/2"



REDA  
 33409-13  
 13,5 cm, 5 1/4"



MARTIN  
 33410-19  
 19 cm, 7 1/2"

Knochenhaltezangen  
 Bone Holding Forceps  
 Pinzas para huesos  
 Tenaglie per ossa



REDA  
 33412-16 - 33412-24

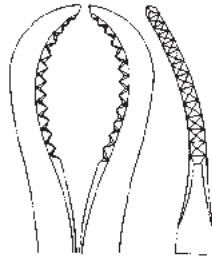

33412-16  
 16 cm, 6 1/4"

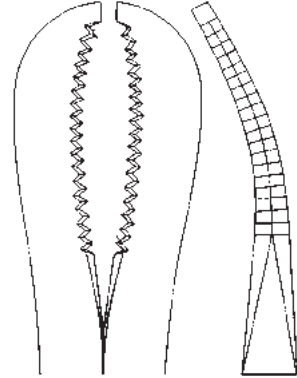

33412-24  
 24 cm, 9 1/2"



REDA  
 33413-14  
 13,5 cm, 5 1/4"



33414-21  
 21 cm, 8 1/4"



Knochenhalte­zangen  
 Bone Holding Forceps  
 Pinzas para huesos  
 Tenaglie per ossa



ULRICH  
 33415-23 - 33415-28



33415-23  
 23 cm, 9"



33415-25  
 25 cm, 10"



33415-28  
 28 cm, 11"

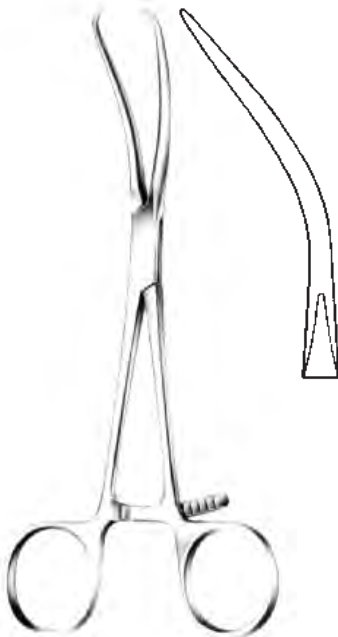

REILL  
 33416-17  
 17 cm, 6 3/4"



PATELLA  
 33417-18  
 18,5 cm, 7 1/4"

Knochenhaltezaugen, -Klammern  
 Bone holding forceps, -Clamps  
 Pinzas para huesos, Clamps porta-huesos  
 Tenaglie per ossa, Pinze per ossa

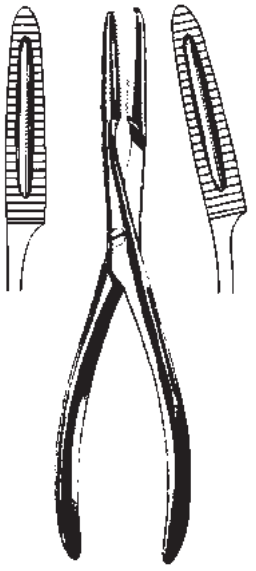

33420-20 33421-20  
 20 cm, 8"

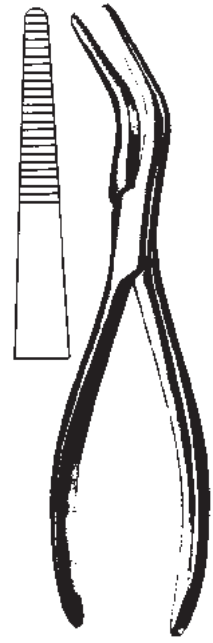

VAN BUREN  
 33423-23  
 23 cm, 9"



FELDHEIM  
 33424-10  
 10 cm, 4"



LOWMAN  
 33441-13 13 cm, 5 1/8"  
 33441-18 18 cm, 7"  
 33441-20 20 cm, 8"



LOWMAN-HOGLUND  
 33442-19  
 19 cm, 7 1/2"

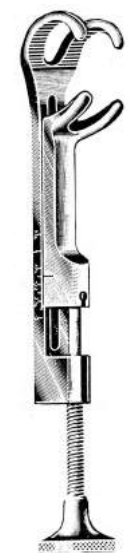

LAMBERT-LOWMAN  
 33443-18  
 18 cm, 7"

Knochenhalte­zangen, Bleihand  
 Bone holding forceps, Lead Hands  
 Pinzas para huesos, Manoplas de plomo  
 Tenaglie per ossa, Mani di piombo

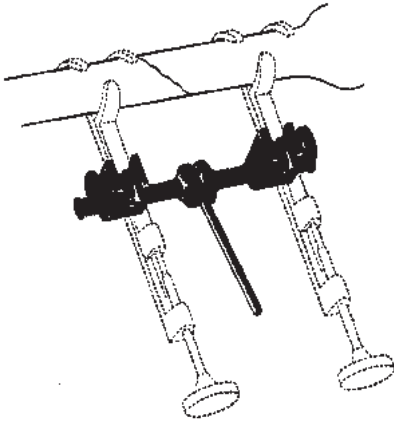

GERSTER  
 33444-15



33450-01  
 32 cm, 12 <sup>3</sup>/<sub>4</sub>"  
 Erwachsen  
 adult size  
 p. adultos  
 p. adulti

33450-02  
 24 cm, 9 <sup>1</sup>/<sub>2</sub>"  
 Kind  
 child size  
 p. niños  
 p. bambini

Scharfe Löffel  
Bone Curettes  
Cucharillas cortantes  
Curette taglianti

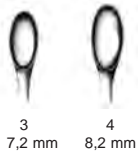
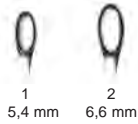
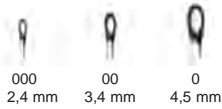

SCHEIDE	Fig.	VOLKMANN
33467-97	0000	33469-96
33467-98	000	33469-97
33468-00	00	33469-98
33468-01	0	33470-00
33468-02	1	33470-01
33468-03	2	33470-02
33468-04	3	33470-03
	4	33470-04
	5	33470-05
	6	33470-06

SCHEIDE  
17 cm, 6 3/4"  
33467-97 - 33468-04

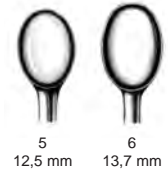
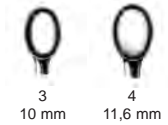
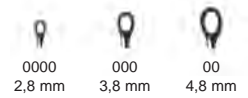

VOLKMANN  
17 cm, 6 3/4"  
33469-96 - 33470-06

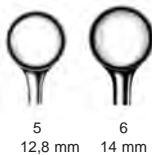
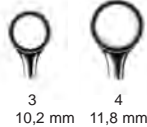

BRUNS	Fig.	SPRATT
33471-96	0000	33474-96
33471-97	000	33474-97
33471-98	00	33474-98
33472-00	0	33475-00
33472-01	1	33475-01
33472-02	2	33475-02
33472-03	3	33475-03
33472-04	4	33475-04
33472-05	5	33475-05
33472-06	6	33475-06

BRUNS  
17 cm, 6 3/4"  
33471-96 - 33472-06

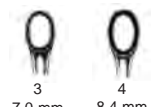
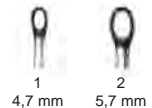
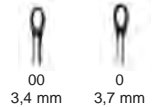

SPRATT  
17 cm, 6 3/4"  
33474-97 - 33475-06

Scharfe Löffel  
 Bone Currettes  
 Cucharillas cortantes  
 Curette taglienti



COBB  
 27,9 cm 11"

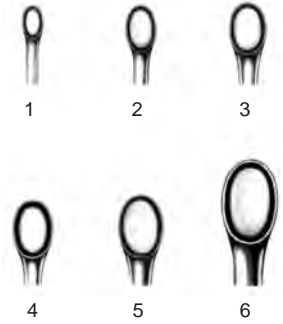

Fig.		
1	33473-01	3,5 mm
2	33473-02	4,5 mm
3	33473-03	5,5 mm
4	33473-04	7,5 mm
5	33473-05	8,5 mm
6	33473-06	10,0 mm

Scharfe Löffel  
Bone Currettes  
Cucharillas cortantes  
Curette taglienti

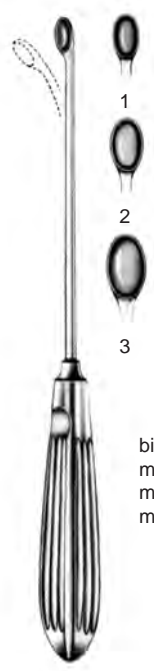

Fig.

1	33476-01	4,8 mm
2	33476-02	5,8 mm
3	33476-03	6,8 mm

biegsam  
malleable  
maleable  
malleabile

**HALLE**  
21 cm, 8 1/4"  
33476-01 - 33476-02



Fig.

000	33476-98	2,8 mm
00	33476-99	3,3 mm
0	33477-00	3,7 mm
1	33477-01	4,3 mm
2	33477-02	4,8 mm
3	33477-03	5,6 mm
4	33477-04	6,1 mm
5	33477-05	6,7 mm
6	33477-06	8,8 mm

**SPINAL**  
20 cm, 8"  
33476-98 - 33477-06

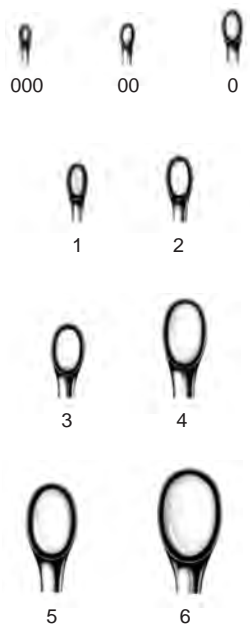
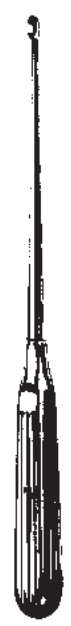

Fig.

000	33478-98	2,8 mm
00	33478-99	3,3 mm
0	33479-00	3,7 mm
1	33479-01	4,3 mm
2	33479-02	4,8 mm
3	33479-03	5,6 mm
4	33479-04	6,1 mm
5	33479-05	6,7 mm
6	33479-06	8,8 mm

**SPINAL**  
20 cm, 8"  
33478-98 - 33479-06



	33482-01	4,7 mm
	33482-02	4,7 mm
	33482-03	4,7 mm

**SCOVILLE**  
25 cm, 10"  
33482-01 - 33482-03

Scharfe Löffel  
 Bone Currettes  
 Cucharillas cortantes  
 Curette taglianti

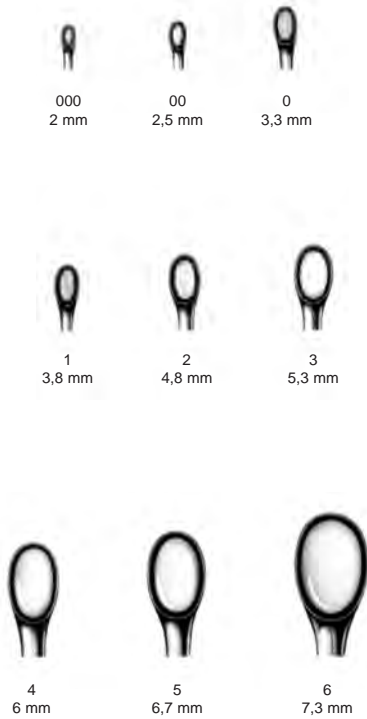

BRUNS  
 23 cm, 9"



BRUNS  
 23 cm, 9"



BRUNS  
 23 cm, 9"

Fig.	33480-97	33482-97	2,8 mm	33484-97	2,8 mm
000	33480-98	33482-98	3,3 mm	33484-98	3,3 mm
0	33481-00	33483-00	3,7 mm	33485-00	3,7 mm
1	33481-01	33483-01	4,3 mm	33485-01	4,3 mm
2	33481-02	33483-02	4,8 mm	33485-02	4,8 mm
3	33481-03	33483-03	5,6 mm	33485-03	5,6 mm
4	33481-04	33483-04	6,1 mm	33485-04	6,1 mm
5	33481-05	33483-05	6,7 mm	33485-05	6,7 mm
6	33481-06	33483-06	8,8 mm	33485-06	8,8 mm

Scharfe Löffel  
Bone Currettes  
Cucharillas cortantes  
Curette taglienti



33485-21 21 cm, 8 1/4"  
oval/rund  
ovale/ronde  
ovalado/redondo  
ovale/rotonda



WILLIGER  
17,5 cm  
7"

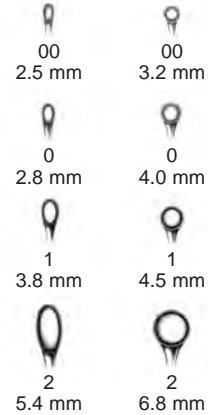
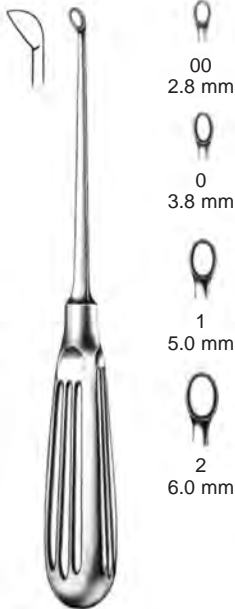

Fig. 00	33485-99	33486-99
0	33486-00	33487-00
1	33486-01	33487-01
2	33486-02	33487-02



DAUBENSPECK	Fig. 00	33487-99
20 cm, 8"	0	33488-00
	1	33488-01
	2	33488-02



27 cm	Fig. 0	33489-00
10 1/2"	1	33489-01
	2	33489-02
	3	33489-03



Scharfe Löffel  
 Bone Currettes  
 Cucharillas cortantes  
 Curette taglianti



LEMPERT  
 17,5 cm, 7"



0



00



000



0000



00000

Fig. 0	33490-10	3,3 mm
00	33490-20	3,0 mm
000	33490-30	2,7 mm
0000	33490-40	2,4 mm
00000	33490-50	2,0 mm



000  
 3,6 mm

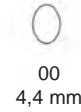

00  
 4,4 mm

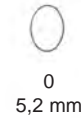

0  
 5,2 mm

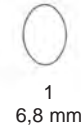

1  
 6,8 mm



REDA  
 25 cm, 10"

Fig. 000	33491-01
00	33491-02
0	33491-03
1	33491-04

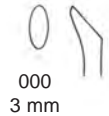

000  
 3 mm



00  
 4 mm

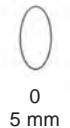

0  
 5 mm

Fig. 000	33491-05
00	33491-06
0	33491-07
1	33491-08



REDA  
 25 cm, 10"



000  
 3,6 mm

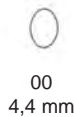

00  
 4,4 mm

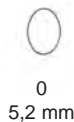

0  
 5,2 mm

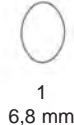

1  
 6,8 mm

Fig. 000	33500-01
00	33500-02
0	33500-03



BUSHE  
 25 cm, 10"

Scharfe Löffel  
Bone Curettes  
Cucharillas cortantes  
Curette taglienti



33492-13 6.3 mm  
33492-16 7.0 mm  
33492-20 9.1 mm

33492-13 6.8 mm  
33492-16 9.0 mm  
33492-20 11.1 mm

**VOLKMANN**

33492-13 13 cm, 5 1/8"  
33492-16 16 cm, 6 1/4"  
33492-20 20 cm, 8"

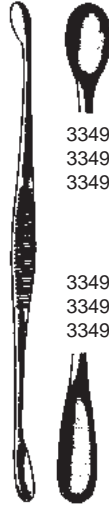

33494-13 7.5 mm  
33494-14 6.8 mm  
33494-17 6.8 mm

33494-13 6.3 mm  
33494-14 6.2 mm  
33494-17 7.3 mm

**VOLKMANN**

33494-13 13 cm, 5 1/8"  
33494-14 14 cm, 5 1/2"  
33494-17 17 cm, 6 3/4"

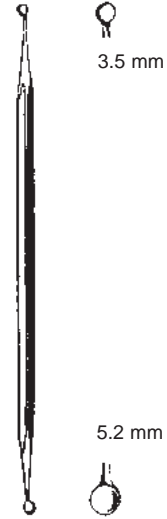

3.5 mm

5.2 mm

**JANSEN**

33495-16  
16 cm, 6 1/4"

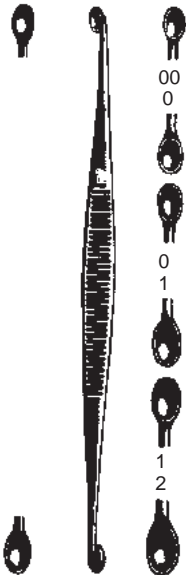

00 2.5 mm  
0 3.0 mm

0 3.0 mm  
1 3.5 mm

1 3.5 mm  
2 4.0 mm

**WILLIGER**

13,5 cm, 5 1/4" Fig.  
33496-00 00/0  
33496-01 0/1  
33496-12 1/2

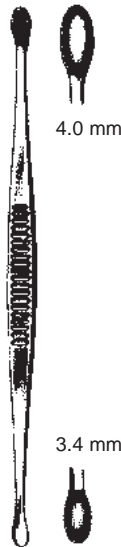

4.0 mm

3.4 mm

**JACOBSON**

13 cm, 5 1/8"  
33497-00

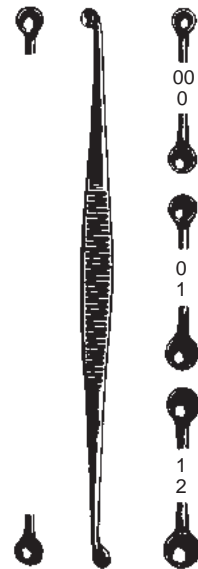

00 2.5 mm  
0 3.1 mm

0 3.1 mm  
1 3.5 mm

1 3.5 mm  
2 4.0 mm

**MARTINI**

13,5 cm, 5 1/4"  
33498-00  
33498-01  
33498-12

Stößel  
Hemostats  
Hemostáticos  
Pistoni



CASPAR  
200 mm, 8"

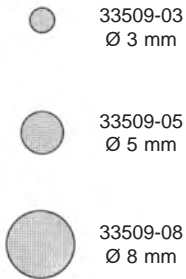

200 mm, 8"

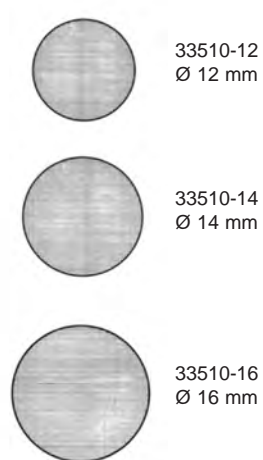

Stößel, Flachmeißel, Hohlmeißel  
 Hemostats, Chisels, Gouges  
 Hemostáticos, Cinceles, Gubias  
 Pistoni, scalpelli, sgorbie

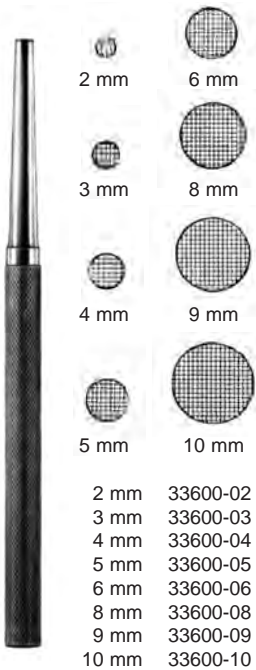

16 cm, 6 1/4"

2 mm	33600-02
3 mm	33600-03
4 mm	33600-04
5 mm	33600-05
6 mm	33600-06
8 mm	33600-08
9 mm	33600-09
10 mm	33600-10



13,5 cm, 5 1/4"

4 mm	33602-04
6 mm	33602-06
8 mm	33602-08
10 mm	33602-10
12 mm	33602-12
14 mm	33602-14
16 mm	33602-16



13,5 cm, 5 1/4"

33604-04
33604-06
33604-08
33604-10
33604-12
33604-14
33604-16



13,5 cm, 5 1/4"

33605-04
33605-06
33605-08
33605-10
33605-12
33605-14
33605-16



ALEXANDER  
17 cm, 6 3/4"

33610-04	4 mm
33610-06	6 mm
33610-08	8 mm
33610-10	10 mm
33610-12	12 mm
33610-14	14 mm



ALEXANDER  
17 cm, 6 3/4"

33611-04	4 mm
33611-06	6 mm
33611-08	8 mm
33611-10	10 mm
33611-12	12 mm
33611-14	14 mm



PARTSCH  
13,5 cm, 5 1/4" mm 17 cm, 6 3/4"

33620-02	2	33622-02
33620-03	3	33622-03
33620-04	4	33622-04
33620-05	5	33622-05
33620-06	6	33622-06
33620-07	7	33622-07
33620-08	8	33622-08

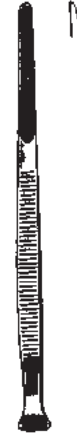

PARTSCH  
13,5 cm, 5 1/4" mm 17 cm, 6 3/4"

33623-02	2	33625-02
33623-03	3	33625-03
33623-04	4	33625-04
33623-05	5	33625-05
33623-06	6	33625-06
33623-07	7	33625-07
33623-08	8	33625-08

Flachmeißel, Hohlmeißel  
 Chisels, Gouges  
 Cinceles, Gubias  
 Scalpelli, sgorbie



**PASSOW**  
 12 cm, 4 3/4"  
 33626-35 3,5 mm  
 33626-25 2,5 mm



**BRÜNINGS-LUCAS**  
 16 cm, 6 1/4"  
 33627-04 4 mm  
 33627-06 6 mm



**BRÜNINGS-LUCAS**  
 16 cm, 6 1/4"  
 33628-03 3 mm  
 33628-05 5 mm



**STILLE**  
 20 cm, 8"  
 33630-06 6 mm  
 33630-08 8 mm  
 33630-10 10 mm  
 33630-12 12 mm  
 33630-15 15 mm  
 33630-20 20 mm  
 33630-25 25 mm  
 33630-30 30 mm



**STILLE**  
 20 cm, 8"  
 6 mm  
 8 mm  
 33631-10 10 mm  
 33631-12 12 mm  
 33631-15 15 mm  
 33631-20 20 mm  
 33631-25 25 mm  
 33631-30 30 mm



**STILLE**  
 20 cm, 8"  
 6 mm 33632-06  
 8 mm 33632-08  
 33632-10  
 33632-12  
 33632-15  
 33632-20  
 33632-25  
 33632-30



**STILLE**  
 20 cm, 8"  
 6 mm 33633-06  
 8 mm 33633-08  
 33633-10  
 33633-12  
 33633-15  
 33633-20  
 33633-25  
 33633-30



**STILLE**  
 20 cm, 8"  
 6 mm 33634-06  
 8 mm 33634-08  
 33634-10  
 33634-12  
 33634-15  
 33634-20  
 33634-25  
 33634-30

Osteotome, Hohlmeißel  
 Chisels, Gouges  
 Cinceles, Gubias  
 Scalpelli, sgorbie



SMITH-PETERSEN  
 20 cm, 8"

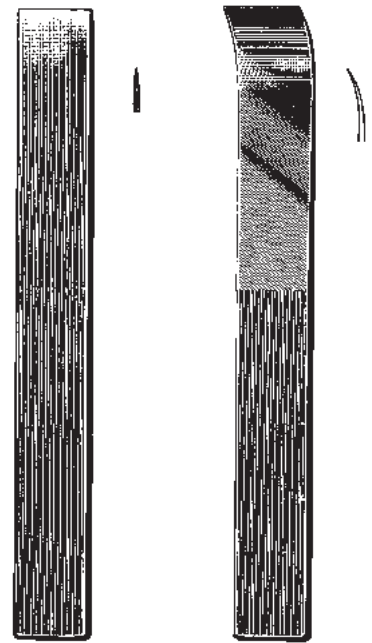

LAMBOTTE  
 24 cm, 9 1/2"      23 cm, 9"

6 mm	33644-06	33645-06	33647-06	
9 mm	33644-09	33645-09	33647-09	33649-09
13 mm	33644-13	33645-13		
14 mm			33647-14	33649-14
16 mm	33644-16	33645-16	33647-16	33649-16
19 mm	33644-19	33645-19	33647-19	33649-19
25 mm	33644-25	33645-25	33647-25	33649-25
32 mm	33644-32	33645-32	33647-32	33649-32

33650-04	4 mm	33651-04
33650-06	6 mm	33651-06
33650-08	8 mm	33651-08
33650-10	10 mm	33651-10
33650-13	13 mm	33651-13
33650-16	16 mm	33651-16
33650-18	18 mm	33651-18
33650-20	20 mm	33651-20
33650-25	25 mm	33651-25
33650-30	30 mm	33651-30
33650-38	38 mm	33651-38
33650-44	44 mm	33651-44
33650-50	50 mm	33651-50

Osteotome, Hohlmeißel  
 Chisels, Gouges  
 Cinceles, Gubias  
 Scalpelli, sgorbie

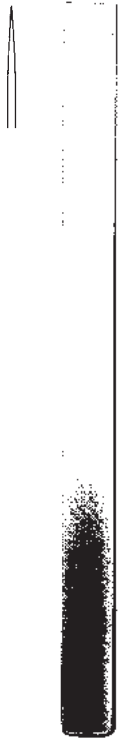

MINI-LAMBOTTE

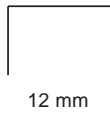

12,5 cm, 5"	mm	17 cm, 6 3/4"
33654-02	2	33652-02
33654-03	3	33652-03
33654-04	4	33652-04
33654-06	6	33652-06
33654-08	8	33652-08
33654-10	10	33652-10
33654-12	12	33652-12
33654-15	15	33652-15

Hohlmeißel mit Ferrozellgriff  
 Gouges with Ferrozell-Handle  
 Gubias con mango de Ferrozell  
 Sgorbie con manico di Ferrozell

8 mm



COBB  
 28 cm, 11"  
 33656-28

8 mm



COBB  
 28 cm, 11"  
 33657-28

8 mm



COBB  
 28 cm, 11"  
 33658-28

8 mm



COBB  
 28 cm, 11"  
 33659-28

Osteotome, Hohlmeißel mit Ferrozell-Griff  
 Chisels and Gouges with Ferrozell-Handle  
 Gubias con mango de Ferrozell  
 Osteotomo, con manico di Ferrozell



LEXER  
 22 cm, 8 3/4"

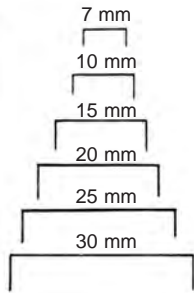

33660-07	7 mm	33661-07
33660-10	10 mm	33661-10
33660-15	15 mm	33661-15
33660-20	20 mm	33661-20
33660-25	25 mm	33661-25
33660-30	30 mm	33661-30

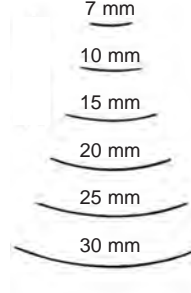

LEXER  
 22 cm, 8 3/4"



LEXER MINI  
 18 cm, 7"

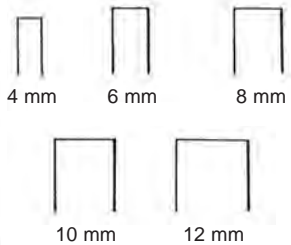

33664-04	4 mm	33665-04
33664-06	6 mm	33665-06
33664-08	8 mm	33665-08
33664-10	10 mm	33665-10
33664-12	12 mm	33665-12

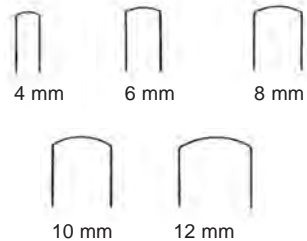

LEXER MINI  
 18 cm, 7"



Flachmeißel, Hohlmeißel  
Chisels, Gouges  
Cinceles, Gubias  
Scalpelli, sgorbie



20 mm

33665-24  
24,5 cm, 9 3/4"



16 mm

33665-26  
26,5 cm, 10 1/2"



ZIELKE 23 cm, 9"  
33665-55 5,5 mm  
33665-90 9,0 mm



9 mm

22 cm, 8 3/4"  
33666-22

Hohlmeißel mit NOVOTEX-Griff  
Gouges with Novotex-Handle  
Gubias con mango de Novotex  
Sgorbie con manico di Novotex

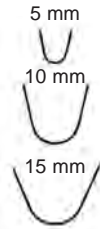

25 cm, 10"

33669-05	5 mm	33670-05
33669-10	10 mm	33670-10
33669-15	15 mm	33670-15

Flachmeißel, Hohlmeißel  
 Chisels, Gouges  
 Cinceles, Gubias  
 Scalpelli, Sgorbie



HOKE

	14 cm, 5 1/2"	
33668-03	3 mm	
33668-05	5 mm	
33668-06	6 mm	
33668-08	8 mm	
33668-09	9 mm	
33668-13	13 mm	
33668-16	16 mm	
33668-19	19 mm	



HIBBS

	24 cm, 9 1/2"	
33670-06	6 mm	
33670-09	9 mm	
33670-13	13 mm	
33670-16	16 mm	
33670-19	19 mm	
33670-25	25 mm	
33670-32	32 mm	



HIBBS

	24 cm, 9 1/2"	
33671-06	6 mm	
33671-09	9 mm	
33671-13	13 mm	
33671-16	16 mm	
33671-19	19 mm	
33671-25	25 mm	
33671-32	32 mm	



HIBBS

	24 cm, 9 1/2"	
33672-06	6 mm	
33672-09	9 mm	
33672-13	13 mm	
33672-16	16 mm	
33672-19	19 mm	
33672-25	25 mm	
33672-32	32 mm	



HIBBS

	24 cm, 9 1/2"	
33673-06	6 mm	
33673-09	9 mm	
33673-13	13 mm	
33673-16	16 mm	
33673-19	19 mm	
33673-25	25 mm	
33673-32	32 mm	



HIBBS

	24 cm, 9 1/2"	
33675-06	6 mm	
33675-09	9 mm	
33675-13	13 mm	
33675-16	16 mm	
33675-19	19 mm	
33675-25	25 mm	
33675-32	32 mm	

Meißel  
Chisels  
Cinceles  
Scalpelli

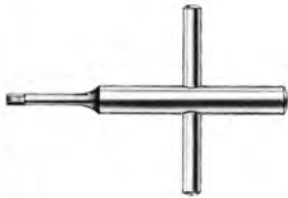

33676-02  
9 cm, 3 1/2"  
Spannschlüssel  
Key  
Llave  
Clé  
Chiave



5 mm  
33676-05  
8,5 mm, 3.4"



10 mm  
33676-10  
8,5 mm, 3.4"



16 mm  
33676-16  
8,5 mm, 3.4"



25 mm  
33676-25  
8,5 mm, 3.4"

Meißelklingen  
auswechselbar  
Chisel blades  
interchangeable  
Hojas de cincel  
intercambiables  
Lame intercambiabili

33676-01  
18,5 cm, 7 1/4"  
Griff allein  
Handle only  
Mango suelto  
Manico solo



5 mm  
33677-05  
8,5 mm, 3.4"



10 mm  
33677-10  
8,5 mm, 3.4"



16 mm  
33677-16  
8,5 mm, 3.4"

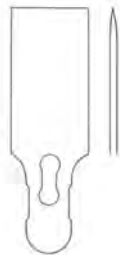

25 mm  
33677-25  
8,5 mm, 3.4"

Osteotomklingen  
auswechselbar  
Osteotome blades  
interchangeable  
Hojas de osteótomo  
intercambiables  
Lame per osteotomia  
intercambiabili

Schädelspalter, Rachiotom, Sternummeißel, Osteotom, Muskelhaken  
 Skull breaker, Rachiotome, Sternum Chisel, Osteotome, Muscle hooks  
 Cincel rompe-cráneo, Raquiótomos, Cinceles de esternón, Osteotomo, Ganchos musculare  
 Divisore per cranio, Rachiotomi, Scalpello per sterno, Osteotomo, Uncino per muscoli



LEBSCHKE  
 33678-24  
 24,5 cm, 9 3/4"



33679-13  
 13 cm, 5 1/8"



33680-22  
 14 cm, 5 1/2"



33682-22  
 22 cm, 8 3/4"



19902-1010 cm, 4"



19903-00



Meißel, Sektionsnadeln  
Chisels, Post mortem needles  
Cinceles, Agujas para autopsia  
Scalpelli, Aghi per autopsia



89146-20 20 cc  
110 x 20 mm

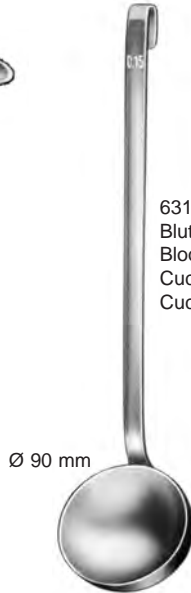

63174-00  
Blutschöpfer, 150 ccm  
Blood scoop, 9 cu. inches  
Cucharra p / sangre  
Cucchiaio per sangue

Ø 90 mm



BRUNETTI  
28,5 cm, 11 1/4"

33682-01	33682-02
links	rechts
left	right
izquierdo	derecho
sinistra	destra

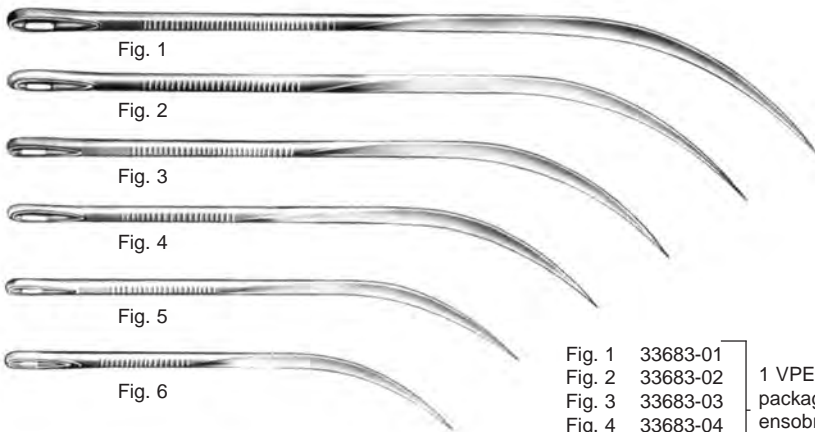

Fig. 1	33683-01	1 VPE = 12 Stk. package of 12 ensobres de 12 confezione di 12
Fig. 2	33683-02	
Fig. 3	33683-03	
Fig. 4	33683-04	
Fig. 5	33683-05	
Fig. 6	33683-06	

Obduktionsbesteck  
 Post Mortem Set  
 Estuches para Autopsia  
 Astucci per Autopsia



33684-00

Kleines Besteck, Holzetui, enthaltend:

- 4 Skalpelle
- 1 Knorpelmesser
- 1 Inzisionsschere, 13 cm (5 1/8")
- 1 Anatomische Pinzette, 13 cm (5 1/8")
- 1 Amputationssäge Charrière
- 1 Hammer
- 1 Meißel
- 2 doppelte Muskelhaken
- 2 doppelte Tubuli
- 2 Knopfsonden, 13 cm (5 1/8")
- 3 Wundnadeln

Small set, wooden case, containing:

- 4 Dissecting Knives
- 1 Cartilage Knife
- 1 Incision Scissors, 13 cm (5 1/8")
- 1 Dissecting Forceps, 13 cm (5 1/8")
- 1 Amputation Saw Charrière
- 1 Mallet
- 1 Chisel
- 2 Retractors, double ended
- 2 Blow pipes, double
- 2 Probes, 13 cm (5 1/8")
- 3 Suture Needles

Modelo pequeño, estuche de madera, conteniendo:

- 4 Escalpelos
- 1 Cuchillo para cartilago
- 1 Tijera de incision, 13 cm (5 1/8")
- 1 Pinza para disección, 13 cm (5 1/8")
- 1 Sierra de amputación Charrière
- 1 Martillo
- 1 Escoplo
- 2 Separadores de 2 gárfios, dobles
- 2 Tubos insufladores, dobles
- 2 Estiletos olivares, 13 cm (5 1/8")
- 3 Agujas para sutura

Modelo piccolo, astuccio di legno, composto da:

- 4 Bisturi
- 1 Coltello per cartilagine
- 1 Forbice per incisione, 13 cm (5 1/8")
- 1 Pinza anatomica, 13 cm (5 1/8")
- 1 Sega per amputazione, Charrière
- 1 Martello
- 1 Scalpello
- 2 Divaricatori con 2 ganci, doppi
- 2 Tubi inalatori, doppi
- 2 Specilli bottonuti, doppi, 13 cm (5 1/8")
- 3 Aghi per sutura



Hämmer  
Bone Hammers and Mallets  
Martillos y mazos  
Martelli

Ø 25 mm



GERZOG  
18 cm, 7"  
33686-25 250 g

Ø 38 mm



KIRK  
19 cm, 7 1/2"  
33687-75 750 g

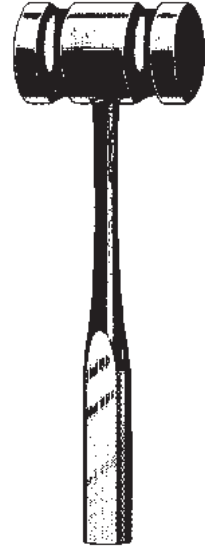

26,5 cm, 10 1/2"  
33688-45 450 g  
33689-90 900 g

Ø 30 mm



COLLIN  
20 cm, 8"  
33690-22 220 g

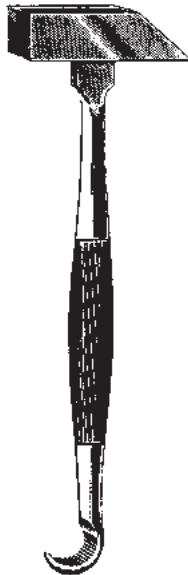

33699-00  
23,5 cm, 9 1/4"  
480 g

Ø 25 mm



33694-01 18,5 cm, 7 1/4"  
33694-03 Ersatzbacken  
Nylon Caps  
Tapas de repuesto  
Placche di ricambio  
135 g

Hämmer  
Bone Hammers and Mallets  
Martillos y mazos  
Martelli



WILLIGER  
24 cm, 9 1/2"  
33691-34 340 g



LUCAE  
19 cm, 7 1/2"  
33692-26 260 g



MEAD  
17 cm, 6 3/4"  
33693-32 320 g

massiv, mit auswechselbaren Ferrozellbacken  
solid, with interchangeable Ferrozell jaws  
macizo, con tapas intercambiables de Ferrozell  
solido, con placche intercambiabili in Ferrozell

33693-33  
Paar Ersatzbacken  
Pair spare jaws  
par de tapas de repuesto  
Coppia di placche di ricambio

33693-34  
Satz Ringe  
Set rings  
juego de anillos  
Set anelli

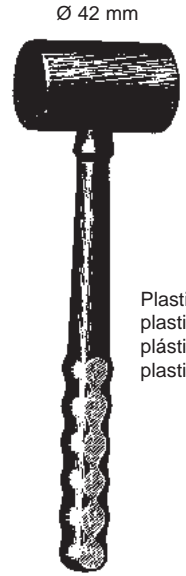

26 cm, 10 1/4"  
33695-40 400 g

Plastik  
plastic  
plástico  
plastica



QUISLING  
33696-75



PARTSCH  
33698-98  
18 cm, 7"  
199 g



33699-17  
26,5 cm, 10 1/2"  
530 g



Hämmer  
 Bone Hammers and Mallets  
 Martillos y mazos  
 Martelli



Hämmer  
Bone Hammers and Mallets  
Martillos y mazos  
Martelli

Ø 30 mm



COTTLE  
18 cm, 7" 240 g  
33700-05

Ø 40 mm



HEATH  
18 cm, 7" 700 g  
33700-06

Ø 40 mm



OMBREDANNE  
25 cm, 10" 700 g  
33700-07

Ø 27 mm



HAJEK  
21 cm, 8 1/4" 140 g  
33700-08

Raspatorien  
 Periosteal Elevators  
 Periostótomos  
 Periostotomi

12,5 mm



**FARABEUF**  
 33702-15  
 15 cm, 5.9"

12,5 mm



**FARABEUF**  
 33703-15  
 15 cm, 5.9"

11 mm

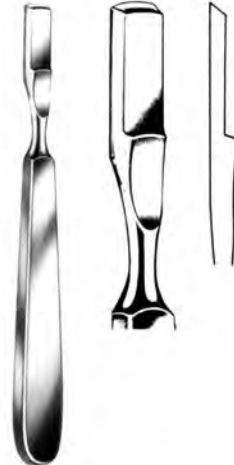

**FARABEUF-COLLIN**  
 33704-01  
 15,5 cm, 6"

11 mm

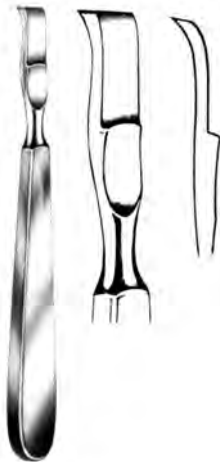

**FARABEUF-COLLIN**  
 33704-02  
 15,5 cm, 6"



**LAMBOTTE**  
 21 cm, 8 1/4"  
 33705-05 5 mm  
 33705-10 10 mm  
 33705-15 15 mm  
 33705-20 20 mm  
 33705-25 25 mm

18 mm



**SEDILLOT**  
 18 cm, 7"  
 33706-18

Raspatorien  
 Periosteal Elevators  
 Periostótomos  
 Periostotomi

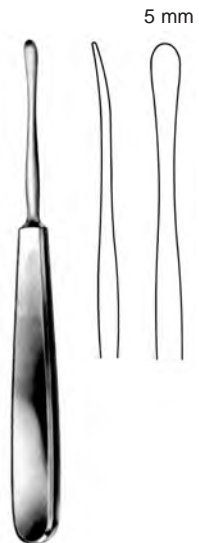

SEBILEAU  
 17,5 cm, 7"  
 33707-17

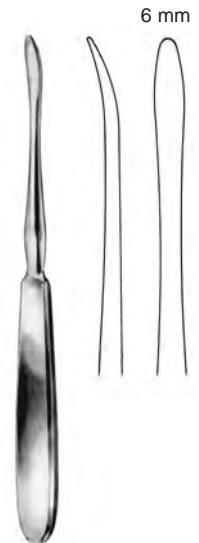

QUERVAIN  
 19,5 cm, 7 3/4"  
 33708-19

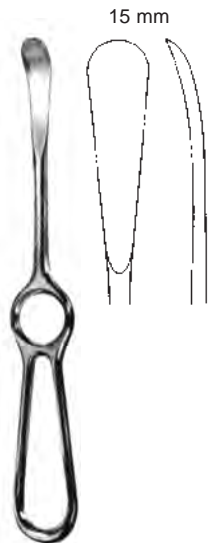

SEDILLOT  
 21 cm, 8 1/4"  
 33709-21



LANGENBECK  
 19 cm, 7 1/2"  
 33710-19



LANGENBECK  
 18 cm, 7"  
 33711-18



LANGENBECK  
 20 cm, 8"  
 33711-20 8 mm  
 33711-21 10 mm

Raspatorien, Elevatoren  
 Raspatories, Elevators  
 Periostótomos, Elevadores  
 Periostotomi, Elevatori

4 mm



WILLIGER  
 33711-16  
 16 cm, 6 1/4"

6,5 mm



WILLIGER  
 33712-16  
 16 cm, 6 1/4"

5 mm



WILLIGER  
 33713-16  
 16 cm, 6 1/4"

5,5 mm



WILLIGER  
 33713-17  
 17 cm, 6 3/4"

5 mm

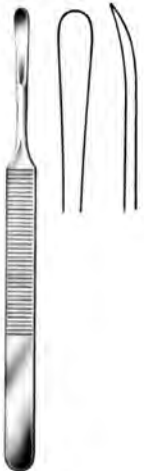

KÖNIG  
 33714-15  
 15,5 cm, 6"

12 mm

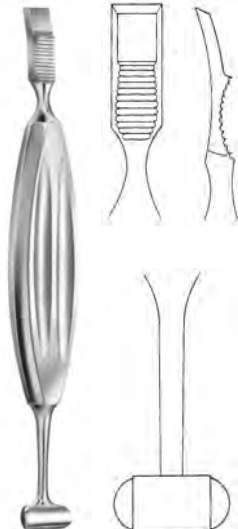

ALEXANDER  
 33715-20  
 21 cm, 8 1/4"



MOLT  
 33716-18  
 18 cm, 7"

Raspatorien, Elevatoren  
 Raspatories, Elevators  
 Periostótomos, Elevadores  
 Periostotomi, Elevatori

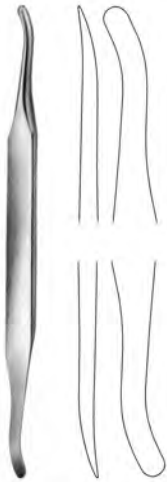

SELDIN  
 33717-19-01  
 19,5 cm 7 3/4"

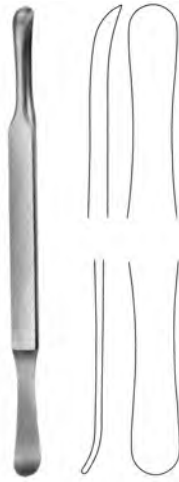

SELDIN  
 33717-19-02  
 19,5 cm 7 3/4"



JOSEPH  
 33718-16  
 16 cm, 6 1/4"



FOMON  
 33719-17  
 17 cm, 6 3/4"



BOIES  
 33720-19  
 19 cm, 7 1/2"



GORNEY  
 33720-21  
 21 cm, 8 1/4"

Raspatorien, Elevatoren  
 Periosteal Elevators  
 Periostótomos, Elevadores  
 Periostotomi, Elevatori



DOYEN  
 17 cm, 6 3/4"

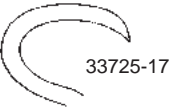
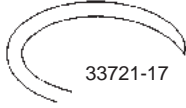

DOYEN  
 17 cm, 6 3/4"

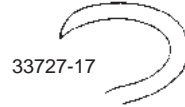
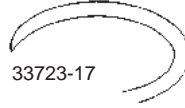

DOYEN  
 33728-24 33729-24  
 24 cm 9 1/2"



SEMB

12 mm



33729-01  
 17,5 cm  
 7"

12 mm



33729-02  
 21 cm  
 8 1/4"

12 mm



33729-03  
 17,5 cm  
 7"

13 mm



33729-04  
 21 cm  
 8 1/4"

15 mm



33729-05  
 20,5 cm  
 8"

15 mm



33729-06  
 20,5 cm  
 8"



33729-07  
 22,5 cm  
 8.9"

Elevatoren, Raspatoren  
 Elevators, Raspatories  
 Elevadores, Periostótomos  
 Elevatori, Periostotomi



**MATSON-ALEXANDER**  
 33731-22  
 22 cm, 8 3/4"



**MATSON**  
 33733-22  
 22 cm, 8 3/4"



**33740-19**  
 19 cm, 7 1/2"



**33741-18**  
 18,5 cm, 7 1/4"



**33742-18**  
 18,5 cm, 7 1/4"



**33743-18**  
 18,5 cm, 7 1/4"





Elevatoren, Raspatoren  
Elevators, Raspatories  
Elevadores, Periostótomos  
Elevatori, Periostotomi

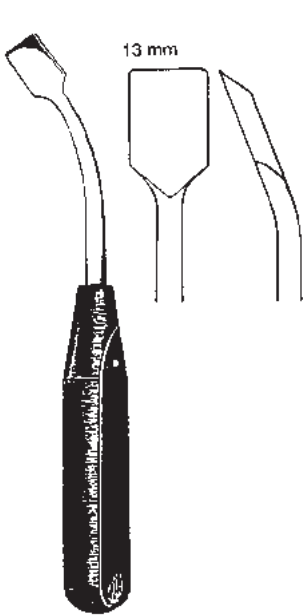

33745-19  
18,5 cm, 7 1/4"



33746-19  
19,5 cm, 7 3/4"

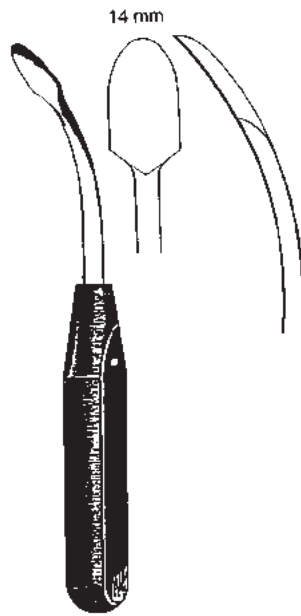

33747-18  
18,5 cm, 7 1/4"

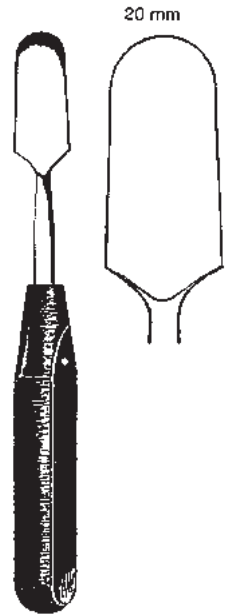

33748-20  
20 cm, 8"

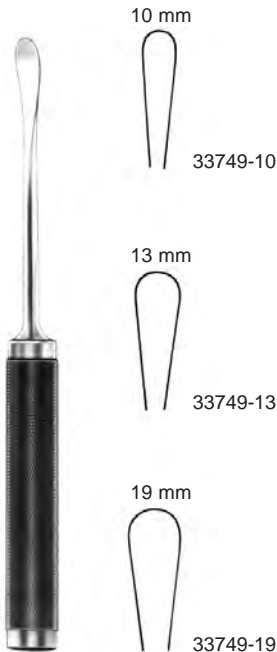

33749-10

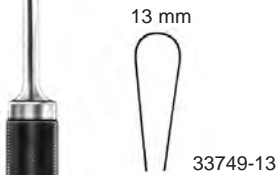

33749-13



33749-19

COBB  
28 cm, 11"



33758-04



33758-06

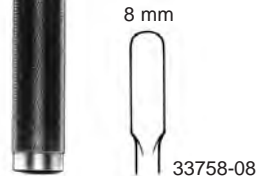

33758-08

COBB  
27 cm, 10 1/2"

Elevatoren  
Elevators  
Elevadores  
Elevatori

scharf  
sharp  
cortante  
tagliente



SAYRE  
17 cm, 6 3/4"  
33758-01

stumpf  
blunt  
romo  
smusso



SAYRE  
17 cm, 6 3/4"  
33758-02

Elevatoren, Knochenheber  
 Elevators, Bone Levers  
 Elevadores para huesos  
 Elevatori, Elevatori per ossa

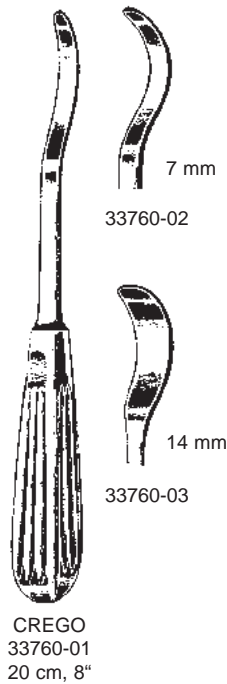
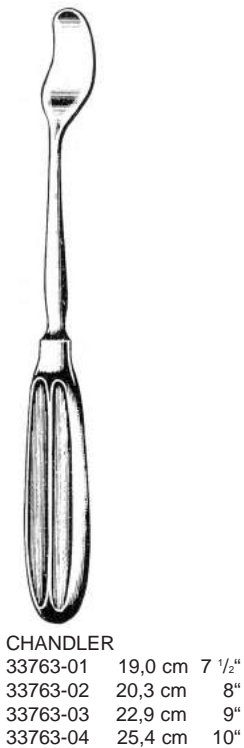
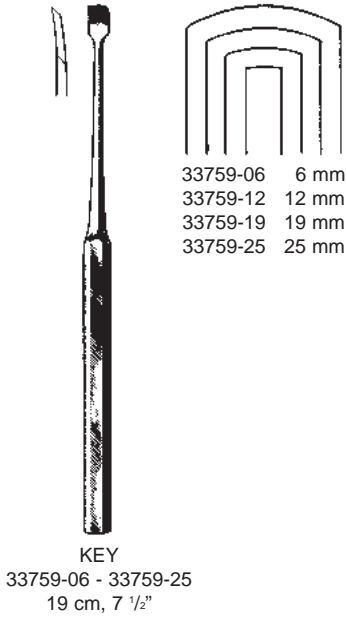
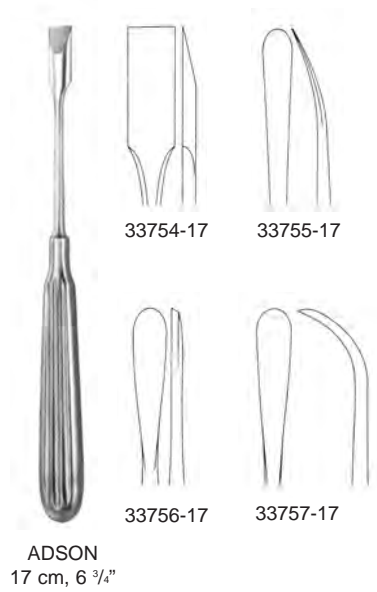

Elevatoren, Knochenhebel  
 Elevators, Bone Levers  
 Elevadores para huesos  
 Elevatori, Elevatori per ossa



WATSON-CHEYNE  
 33765-17  
 17,5 cm, 7"



MC DONALD  
 33767-19  
 19 cm, 7 1/2"



MURPHY-LANE  
 33769-30  
 30 cm, 11 3/4"



BENNETT  
 33771-71  
 65x260 mm



BENNETT  
 33771-73  
 45x260 mm

Knochenhebel  
 Bone Levers  
 Elevadores para huesos  
 Elevatori per ossa

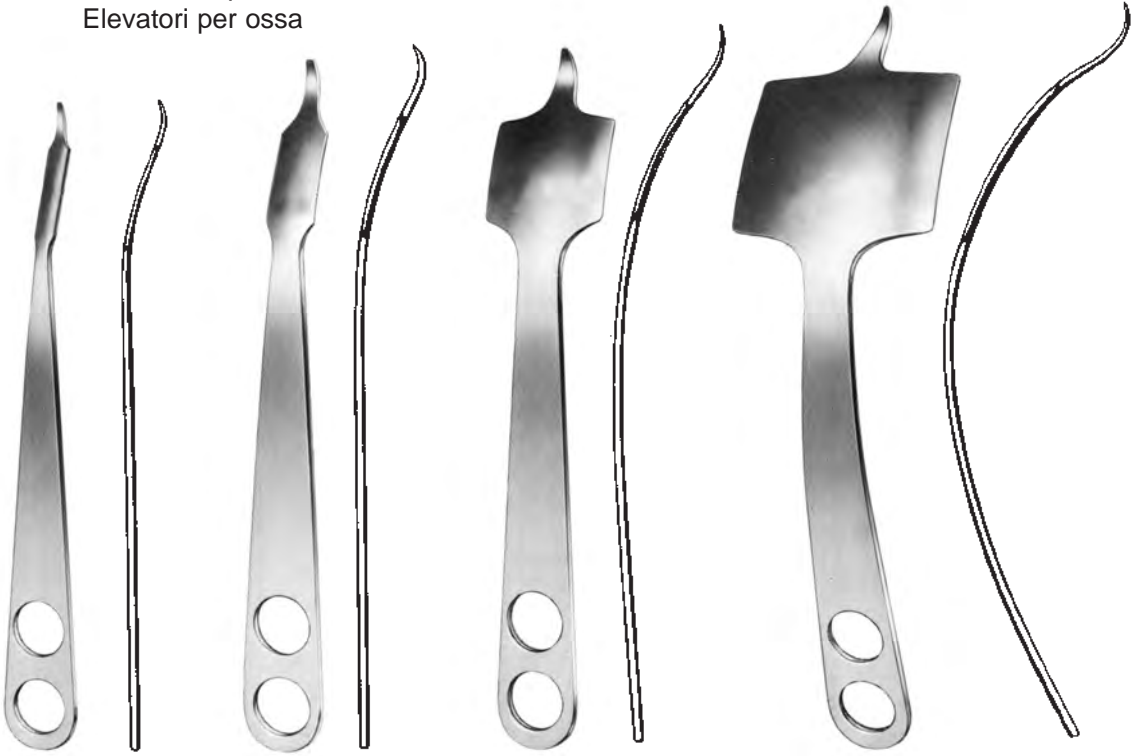

HOHMANN  
 33801-08 8 mm  
 33801-12 12 mm

HOHMANN  
 33801-18  
 18 mm, 3/4"

HOHMANN  
 33801-43  
 43 mm, 1 3/4"

HOHMANN  
 33801-70  
 70 mm, 2 3/4"

4,5 mm



KÖNIG  
 33802-01  
 15 cm, 6"

4,5 mm



KÖNIG  
 33802-02  
 15 cm, 6"

2,8 mm



33802-14  
 14 cm, 5 1/2"

5 mm



33803-05  
 15 cm, 6"

7 mm



33803-07  
 15 cm, 6"

Knochenhebel  
 Bone Levers  
 Elevadores para huesos  
 Elevatori per ossa



**HOHMANN**  
 33803-43 43 mm

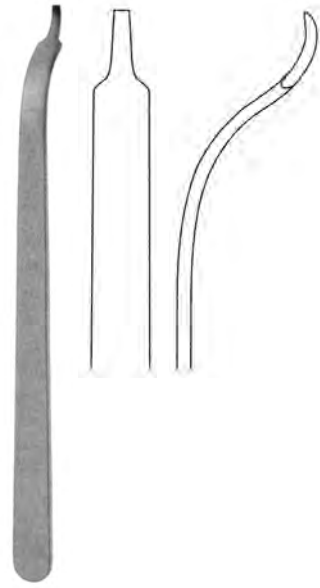

**BUCK-GRAMCKO**  
 33804-15 15 mm



**HOHMANN**  
 33805-22 22 mm



**HOHMANN**  
 33805-33 33 mm



**HOHMANN**  
 33807-24 24 mm



**HOHMANN**  
 33809-22 22 mm

Knochenhebel  
 Bone Levers  
 Elevadores para huesos  
 Elevatori per ossa

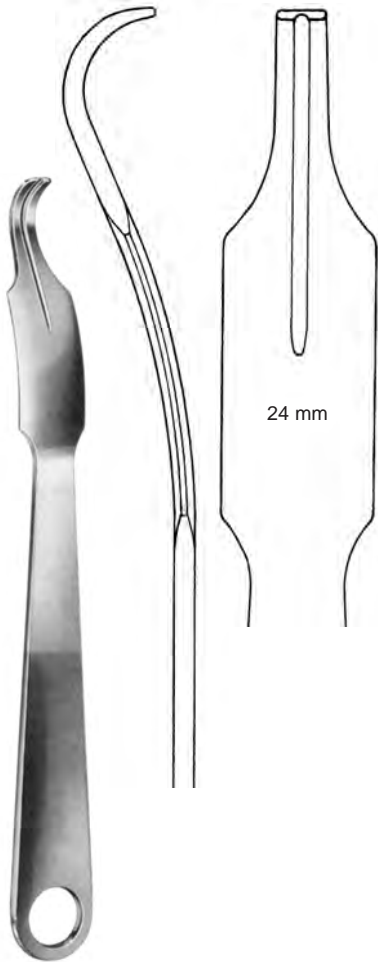

LANGE-HOHMANN  
 33810-24  
 25 cm, 10"



HOHMANN mini  
 16 cm, 6 1/4"

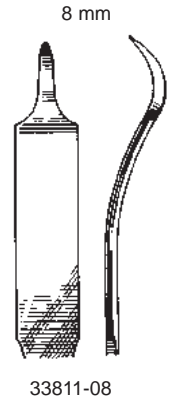
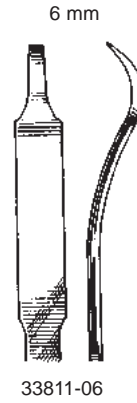

Knochenhebel  
Bone Levers  
Elevadores para huesos  
Elevatori per ossa

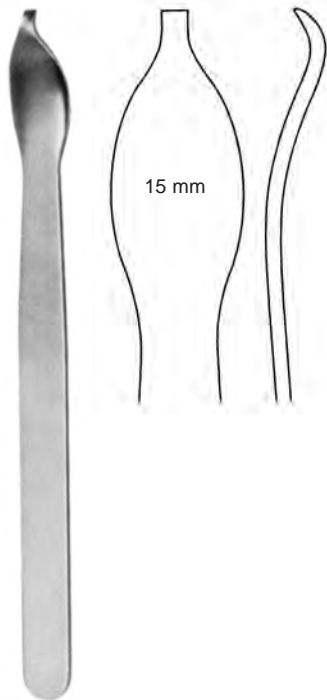

33812-16  
16 cm, 6 1/4"

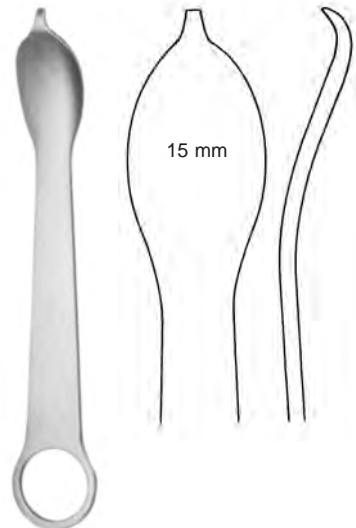

33813-12  
12 cm, 4 3/4"



Knochenheber  
Bone Levers  
Elevadores para huesos  
Elevatori per ossa

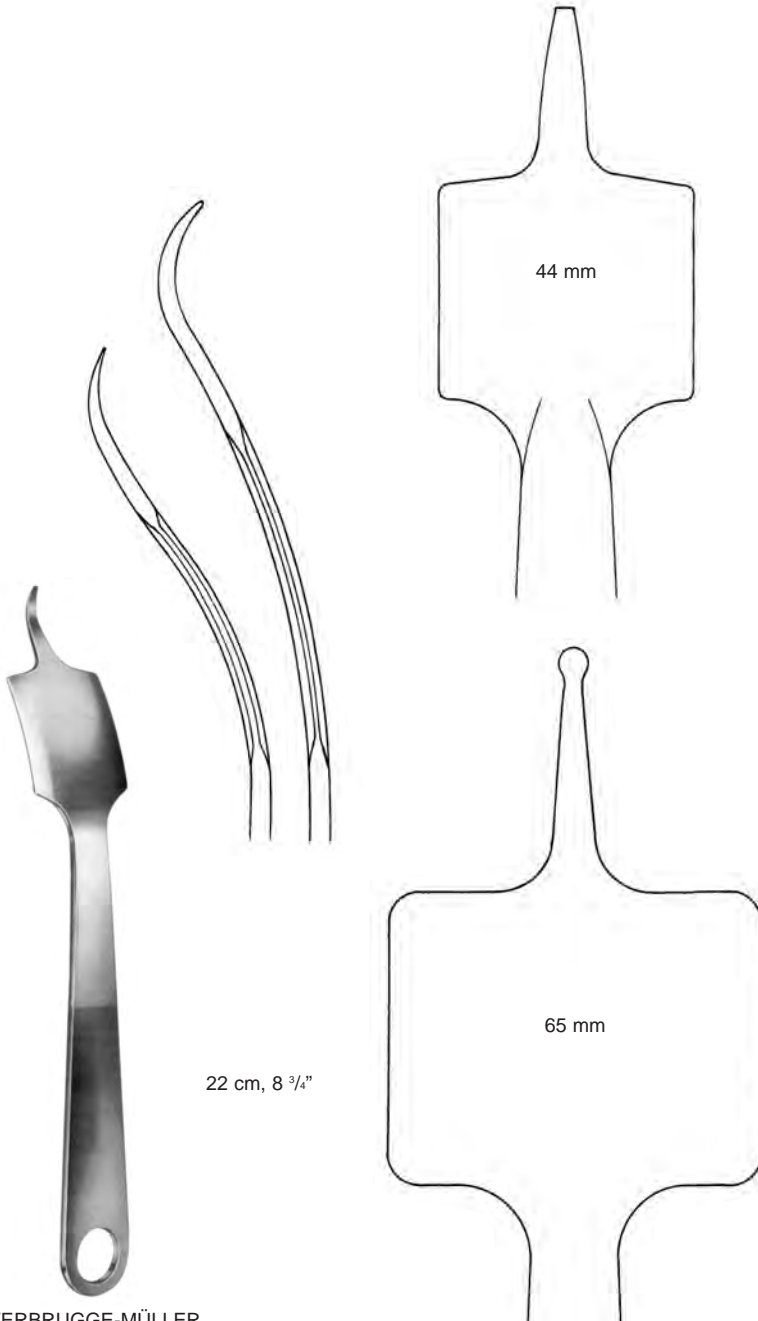

VERBRUGGE-MÜLLER  
33814-44 24,0 cm, 9 <sup>1</sup>/<sub>2</sub>"  
33814-65 25,5 cm, 10"

Knochenhebel  
Bone Levers  
Elevadores para huesos  
Elevatori per ossa



BLOUNT  
33823-26  
26 cm, 10 1/4"

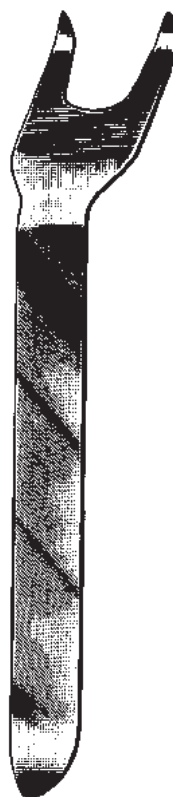

BLOUNT  
33825-26  
26 cm, 10 1/4"

Bauchdeckenhalter, Knochenheber, Meniskushaken  
 Abdominal Retractor, Bone Levers, Meniscus Retractors  
 Separador abdominal, Elevadores p. huesos, Separadores para menisco  
 Divaricatori abdominali, Elevatori per ossa, Divaricatori per il menisco

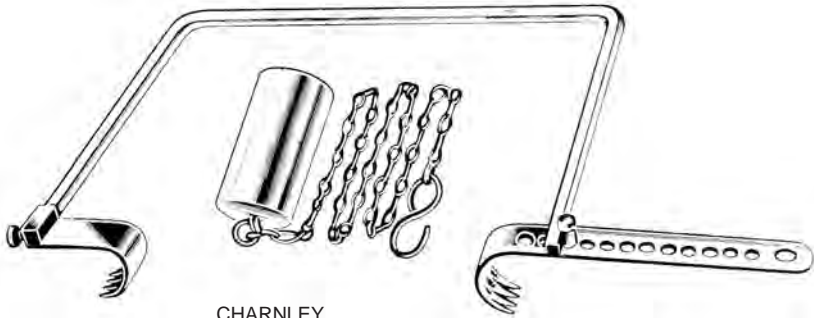

CHARNLEY  
33826-00

33826-01 spitz, gerieft  
 pointed tip, serrated  
 punta aguda, dentada  
 punta acuta, zigrinata

33826-02 stumpf, gerieft  
 blunt tip, serrated  
 punta roma, dentada  
 punta smussa, zigrinata

33826-03 stumpf, glatt  
 blunt tip, smooth  
 punta roma, lisa  
 punta smussa, liscia



AUFRANC-COBRA  
26 cm 10 1/4"

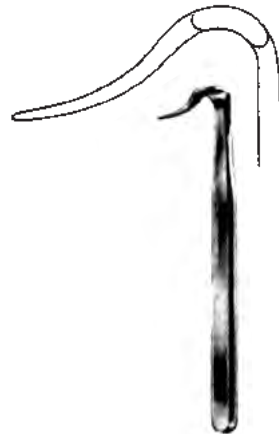

BLOUNT  
33827-17  
17,5 cm 7"

Knochenhebel  
Bone Levers  
Elevadores p. huesos  
Elevatori per ossa



LANE TRETHOWAN  
33828-21  
21,5 cm 8 1/2"



LANE  
33829-25  
25,5 cm 10"

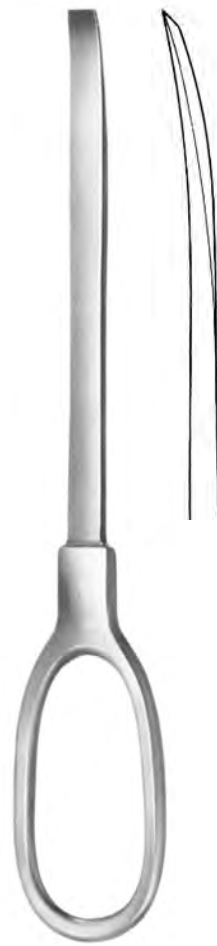

BRISTOW  
33830-23  
23 cm 9"

Knochenheber, Meniskushaken  
 Bone Levers, Meniscus Retractors  
 Elevadores p. huesos, Separadores para menisco  
 Elevatori per ossa, Divaricatori per il menisco



**TAYLOR**  
 16,5 cm, 6 1/2"  
 33831-16 75x30 mm  
 33833-16 100x30 mm



12 x 13 mm  
 33832-01



52 x 13 mm  
 33832-02



32 x 19 mm  
 33832-03

48 x 19 mm  
 33832-04

57 x 19 mm  
 33832-05

**SMILLIE**  
 14 cm, 5 1/2"

Sehenschäler, Sehnenfaßspinzette, Sehnenhaltezange, Sehnenfaßinstrumente  
 Tendon seizing instruments  
 Instrumentos para coger tendones  
 Enucleatore di tendine, Strumenti per afferrare tendini



**SMILLIE**  
 33910-17  
 17 cm, 6 3/4"

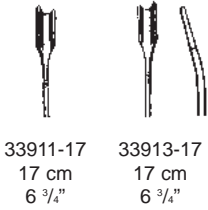

33911-17 17 cm 6 3/4"  
 33913-17 17 cm 6 3/4"

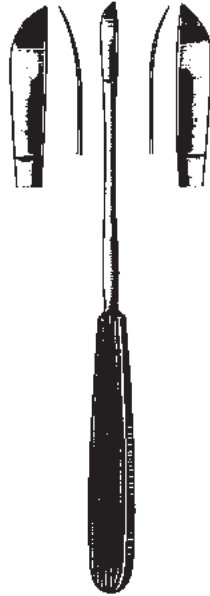

**NEFF**  
 33921-22 - 33923-22  
 22 cm, 8 3/4"



**BUNELL**  
 33950-01 - 33950-05  
 15 cm, 6"

33950-01 3 mm  
 33950-02 4 mm  
 33950-03 5 mm  
 33950-04 6 mm  
 33950-05 7 mm



**LARSEN**  
 33960-15 - 33960-55  
 10 cm, 4"

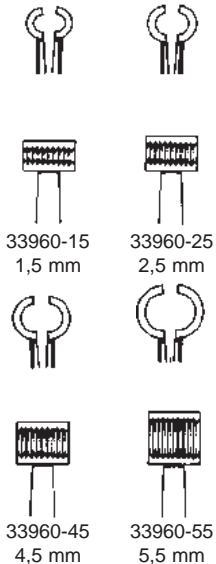

33960-15 1,5 mm  
 33960-25 2,5 mm  
 33960-45 4,5 mm  
 33960-55 5,5 mm



**JACKSON**  
 33961-15  
 15 cm, 6"

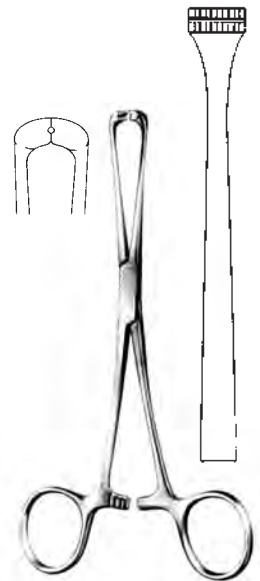

**STEINMANN**  
 33962-16  
 16 cm, 6 1/4"



Sehnenfaßinstrumente, Sehnenführer  
Tendon seizing instruments, Tendon passing instr.  
Instrumentos para coger tendones, Instrumento p. el tunel del tendon  
Strumenti per afferrare tendini



33963-12  
12 cm, 4 3/4"



BRAND  
33964-15 - 33964-24

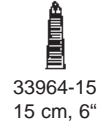

33964-15  
15 cm, 6"



33964-19  
19 cm, 7 1/2"



33964-24  
24 cm, 9 1/2"



BRAND  
33965-15 15 cm, 6"  
33965-19 19 cm, 7 1/2"  
33965-24 24 cm, 9 1/2"



CAROLL  
33966-11  
11 cm, 4 3/8"



33966-15 15 cm, 6"

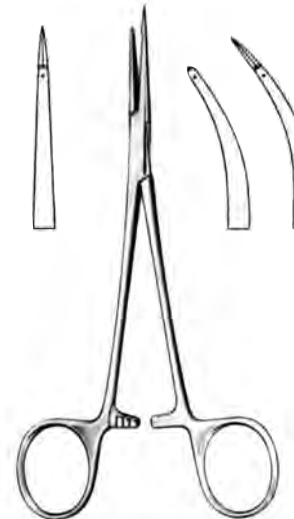

33967-15

Sehnenfassinstrumente, Sehnenstripper, Knochenfeilen, Raspeln  
 Tendon seizing instruments, Tendon Strippers, Bone Files, Rasps  
 Instrumentos para coger tendones, Enucleadores de tendones, Limas, Escofinas  
 Strumenti per afferrare tendini, Scollatendini, Lime per ossa, Raspe



**KLEINERT-KUTZ**  
 33967-20  
 20 cm, 8"



ø 3 mm  
 33968-30  
 30 cm, 11 3/4"

ø 6 mm  
 33968-60  
 50 cm, 19 1/2"

**BRAND**



biegsam  
 malleable  
 maleable  
 malleabile

**BUNELL**  
 33969-18 18 cm, 7"  
 33969-23 23 cm, 9"



biegsamer Schaft  
 flexible shaft  
 vastago maleabile  
 camicia flessibile

**BUNELL 23 cm**  
 33970-01 ø 4,0 mm  
 33970-02 ø 4,5 mm  
 33970-03 ø 5,5 mm



33971-24  
 24,5 cm, 9 3/4"



33972-22  
 22 cm, 8 3/4"



**PUTTI**  
 33973-27  
 27 cm, 10 1/2"



**PUTTI**  
 33975-30  
 30 cm, 11 3/4"



33977-28  
 28 cm, 11"

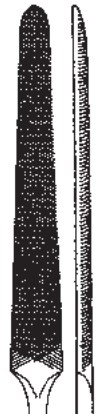



Amputations- und Resektionssägen  
 Amputation and Resection Saws  
 Sierras para amputación y resección  
 Seghe per amputazione e resezione

Staubbinde  
 Compression bandage  
 Vendaje de compresión  
 Benda per compressione  
 5 m lang / long  
 6 cm breit / wide



ESMARCH  
 34105-01

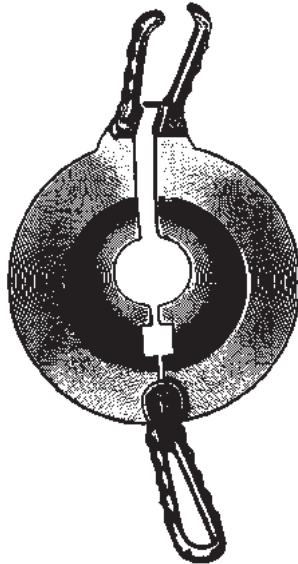

PERCY  
 34110-00



CHARRIERE  
 34112-00

34112-01  
 12 mm

Ersatzsägeblätter  
 Spare saw blades  
 Hojas de sierra de  
 repuesto  
 Lame di ricambio

34112-02  
 15 mm

Ersatzsägeblätter  
 Spare saw blades  
 Hojas de sierra de  
 repuesto  
 Lame di ricambio

komplett mit 2 Blättern  
 complete with 2 blades  
 completo con 2 hojas  
 completa con 2 lame



mit 3 Sägeblätter  
 4 - 6 - 8 mm  
 con 3 hojas de repuesto  
 with 3 spare blade  
 con 3 lame di ricambio

BIER  
 34114-39  
 40,5 cm, 16"



CHARRIERE  
 34116-30  
 30 cm, 11 3/4"

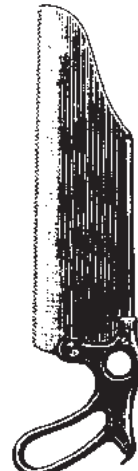

SATTERLEE  
 34118-31  
 31 cm, 12 1/4"



LANGENBECK  
 34120-23  
 23 cm, 9"



Nagelausreißzange, Fingerringsägen  
Fcps. f. tearing out finger nails, Finger Ring Saws  
Pinzas para arrancar uñas, Sierras para abrir anillos  
Pinze per lacerazione delle unghie, Seghe per anelli

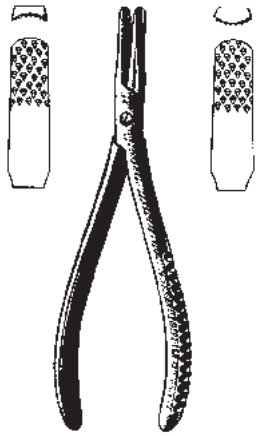

**RADOLF**

- 34161-13 13,5 cm, 5 1/4" 3 mm
- 34162-13 13,5 cm, 5 1/4" 6 mm



34172-01

**WALTON**  
34172-00

Sägeblatt  
Saw blade  
Hoja de sierra  
Lama di ricambio



34175-01

**REDA**  
34175-00

Sägeblatt  
Saw blade  
Hoja de sierra  
Lama di ricambio

Bohrapparate  
 Bone Hand Drills  
 Perforador de mano  
 Perforatori a mano

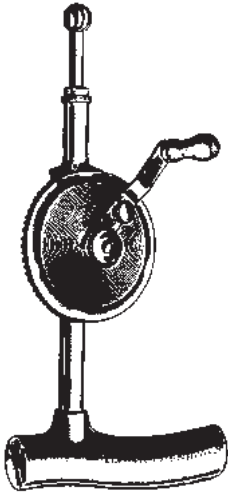

**STILLE**  
 34210-20 20 cm, 8"  
 compl. incl. 34212-25 - 34214-16

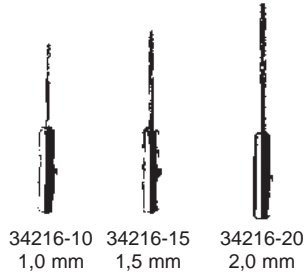
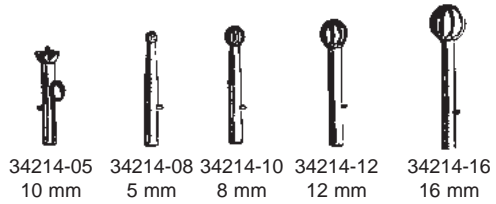
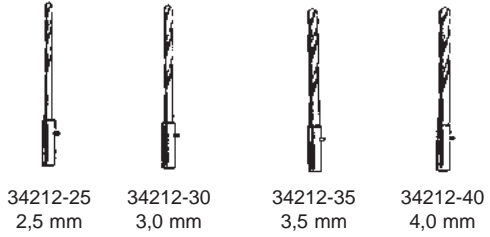

**STILLE-SHERMAN**  
 34220-24 24 cm, 9 1/2"  
 compl. incl. 34222-25 - 34222-35



**MOORE**  
 34230-28 28 cm, 11"  
 compl. incl. 34232-00

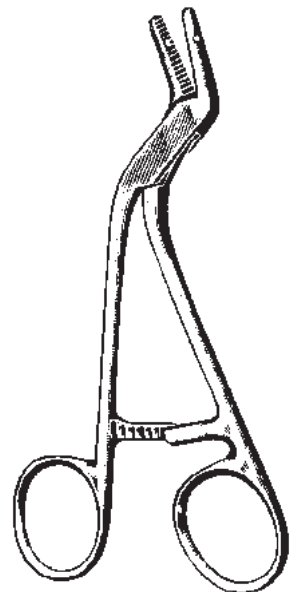

**ADSON**  
 34231-15  
 15 cm, 6"

Bohrapparate  
 Bone Hand Drills  
 Perforador de mano  
 Perforatori a mano



34241-00  
 Griff allein  
 Handle only  
 Mango solo  
 Manico solo

HUDSON  
 34240-27 27 cm, 10 1/2"  
 compl. incl. 34242-09, -14, -16, -22,  
 34246-00



34242-09  
 9 mm



34242-14  
 14 mm



34242-16  
 16 mm



34242-22  
 22 mm



ø 2 mm  
 34243-02



CUSHING  
 34244-10  
 34244-14  
 34244-16



ERRICO  
 34244-17  
 ø 16 mm



MC KENZIE  
 34248-00  
 ø 13 mm



34246-00  
 Verlängerungsstück  
 Extension piece  
 Pieza alargadera  
 Giunto di prolungamento



KIRSCHNER  
 34250-00 compl.



34252-00



BUNELL  
 34270-00 16 cm, 6 1/4"

34270-01  
 Schlüssel  
 Wrench  
 Llave  
 Chiave

Bohrapparat 16 cm (6 1/4"), längsdurchbohrt mit Dreibackenspannfutter und Schlüssel, Spannweite bis 4 mm  
 Hand drill, 16 cm (6 1/4"), longitudinally bored, with three-jaw-chuck and key, opening up to 4 mm

Perforador manual, 16 cm (6 1/4"), taladrado longitudinalmente, con mandril de tres mordazas y llave, abriendo hasta 4 mm

Perforatore a mano, 16 cm (6 1/4"), con perforazione assiale, con mandrino a tre ganasce e chiave, apertura fino a 4 mm di D.

Bohrapparate, Handgriffe  
 Bone Hand Drills, Handles  
 Perforador de mano  
 Perforatori a mano, manici



RALK  
34280-00



REDA  
34290-00



34295-00

Spannschlüssel allein  
 Key only  
 Llave suelta  
 Chiave solo



34296-00

Handgriff mit Jacobs-  
 spannfutter und  
 Spannschlüssel  
 Handle with Jacobs chuck  
 and key  
 Mango con cierre Jacobs,  
 de 3 mordazas y llave  
 Manico con mandrino di  
 Jacobs e chiave

Bohrapparat mit Leichtmetallgehäuse, mit Dreibackenspannfutter und Schlüssel. Spannweite bis D. 6,35 mm  
 Hand drill with light metal case, with three-jaw-chuck and key, opening up to D. 6,35 mm  
 Perforador manual con caja de aluminio, con mandril de tres mordazas y llave, abriendo hasta 6,35 mm de D.  
 Perforatore a mano con cassa in metallo leggero, con mandrino a tre ganasce e chiave, apertura fino a 6,35 mm di D.

Handbohrapparat mit umstellbarem Handgriff, mit Jacobs Dreibackenspannfutter und Schlüssel  
 Hand drill with adjustable handle, with Jacobs three-jaw-chuck and wrench  
 Perforador de mano en T con cierre Jacobs de 3 mordazas y llave de ajuste  
 Perforatore a mano con manico regolabile, con mandrino a tre ganasce di Jacobs e chiave



34296-05

T-Handgriff, verriegelbares schlüsselloses Dreibackenspannfutter, rostfrei  
 T-handle, keyless locking chuck  
 Mango en T, mordaza sin llave, inox.  
 Chiave a T con mandrino a tre ganasce inox



34296-10

Handgriff, Dreibackenspannfutter, inkl. Spannschlüssel rostfrei  
 Handle with chuck, including key  
 Mango, mordaza incluyendo llave, inox.  
 Mandrino a tre ganasce con manico recto completo di chiave di arresto inox



34296-15

"Hudson" T-Handgriff, Schnellkupplung  
 Hudson T-handle with fast gripping chuck  
 Mango en T, acople rápido  
 Hudson: mandrino con manico a T  
 Ganasce con raccordo rapido



34296-20

Schnellkupplungs T-Handgriff, groß  
 T-handle with fast gripping chuck, large  
 Mango en T, acople rápido, grande  
 Mandrino a T manico grande  
 Raccordo rapido

Schnellkupplungs-Handgriffe, Bohrapparat elektr.  
 Handles with quick action chuck, Bone drill electr.  
 Perforador electrico y mangos de acople rápido  
 Manici con attachi rapidi, Perforatori elettr.



34296-25  
 Schnellkupplungs-T-Handgriff  
 T-Handle, quick-action  
 Mango en T, acople rápido  
 Mandrino a T con raccordo rapido



34296-30  
 Schnellkupplungs-Handgriff  
 groß mit Hartgewebegriff  
 Handle, quick-action, large,  
 handle made of very hard fibre  
 Mango de acople rápido,  
 grande, de material extraduro  
 Mandrino grande rapido con  
 manico a fibre dure



34296-35  
 Schnellkupplungs-Handgriff  
 mit Hartgewebegriff  
 Handle, quick-action,  
 made of very hard fibre  
 Mango de acople rápido,  
 de material extra-duro  
 Mandrino medio rapido con  
 manico a fibre dure



34296-40  
 Mini Schnellkupplungs-Handgriff  
 für „Dental“-Anschluß  
 Mini-Handle, quick-action,  
 "dental"  
 Mini-Mango de acople rápido  
 "dental"  
 Mini mandrino-rapido con  
 impugnatura cilindrica con  
 attacco dentale



Bohrer  
Drill bits  
Taladros  
Perforatore



Ø		
1,0 mm	56 mm	34320-10
1,5 mm	70 mm	34320-15
2,0 mm	85 mm	34320-20
2,5 mm	95 mm	34320-25
2,7 mm	100 mm	34320-27
3,0 mm	100 mm	34320-30
3,2 mm	106 mm	34320-32
3,5 mm	112 mm	34320-35
4,0 mm	119 mm	34320-40
4,5 mm	126 mm	34320-45
5,0 mm	132 mm	34320-50
6,0 mm	139 mm	34320-60
7,0 mm	156 mm	34320-70



Ø		
1,0 mm	180 mm	34321-10
1,5 mm	180 mm	34321-15
2,0 mm	180 mm	34321-20
2,5 mm	180 mm	34321-25
2,7 mm	180 mm	34321-27
3,0 mm	180 mm	34321-30
3,2 mm	180 mm	34321-32
3,5 mm	180 mm	34321-35
4,0 mm	180 mm	34321-40
4,5 mm	180 mm	34321-45
5,0 mm	180 mm	34321-50
6,0 mm	180 mm	34321-60
6,5 mm	180 mm	34321-65
7,0 mm	180 mm	34321-70
8,0 mm	180 mm	34321-80
9,0 mm	180 mm	34321-90
10,0 mm	180 mm	34322-00

Spiralbohrer mit Glattschaft  
Twist Drills with round end  
Taladros espirales con vástago redondo  
Perforatore elicoidale

Spiralbohrer mit Glattschaft langes Modell  
Twist Drills, long typ  
Taladros espirales, largos  
Perforatore elicoidale, modello lungo



Ø		
1,1 mm	60 mm	34322-11
1,5 mm	85 mm	34322-15
2,0 mm	100 mm	34322-20
2,5 mm	110 mm	34322-25
2,7 mm	100 mm	34322-27
3,2 mm	145 mm	34322-32
3,5 mm	110 mm	34322-35
4,5 mm	145 mm	34322-45

Spiralbohrer mit Schnellkupplungs-Ansatz  
Twist Drills, quick-action  
Taladros espirales, acople rápido  
Perforatore elicoidale con attacco rapido

Pfrieme, Reibahle  
 Awl, Reamer  
 Escariadores  
 Lesine, Punteruoli



34392-14  
 14 cm, 5 1/2"



PERTHES  
 34393-18  
 18 cm, 7"

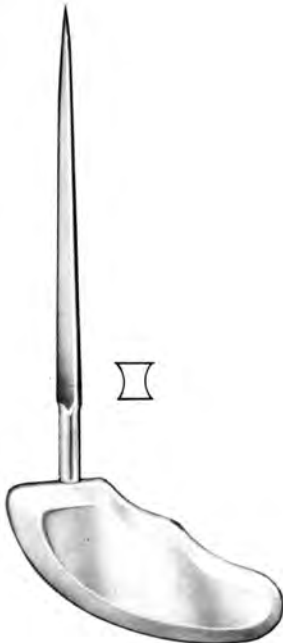

PERTHES  
 34393-2121 cm, 8 1/4"



34394-14  
 14 cm, 5 1/2"



Faßpinzette, Bohrdrahtspender  
 Grasping forceps, Support for sterilisation  
 Pinzas para coger, Soporte de esterilización  
 Pinze per afferrare, Supporto per la sterilizzazione



34439-00

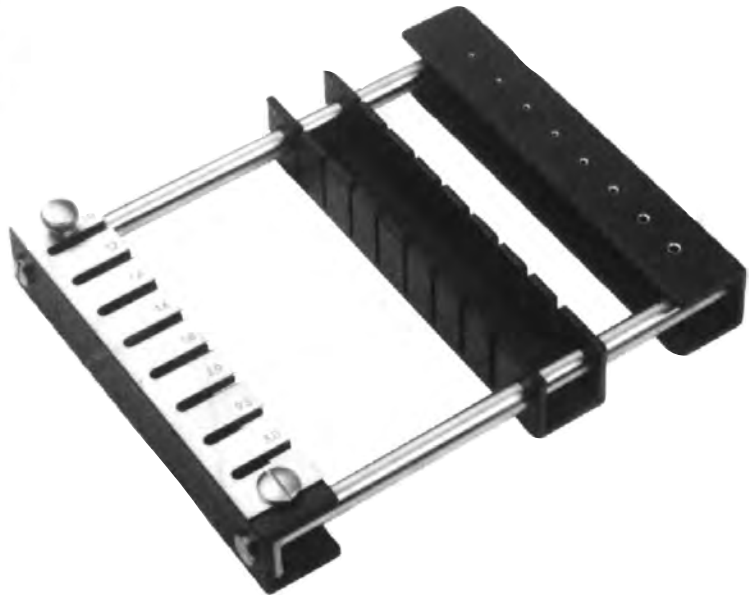

Bohrdrahtspender für Kirschner-Drähte  
 Support for sterilisation of Kirschner wires  
 Soporte de esterilización p. alambres de Kirschner  
 Supporto per la sterilizzazione dei fili di Kirschner

34440-01 bis 15 cm – up to 15 cm (6") – hasta 15 cm – fino a 15 cm  
 34440-02 bis 31 cm – up to 31 cm (12 1/4") – hasta 31 cm – fino a 31 cm  
 34440-03 bis 10 cm – up to 10 cm (4") – hasta 10 cm – fino a 10 cm



# MAST.SH-GERMANY

Bohrdrähte  
Drill Wires  
Alambres  
Perforatori filiformi

lieferbar in Packungen à 10 Stück  
available in packages of 10 pieces  
disponible en paquets de 10 unidades  
disponibili solo in confezioni da 10 pezzi

Trokarspitze / Trocar point  
Punta trocar / Punte trequarti



Ø	10 cm, 4"	15 cm, 6"	31 cm, 12 1/4"
0,8	34401-08	34402-08	34403-08
1,0	34401-10	34402-10	34403-10
1,1	34401-11	34402-11	34403-11
1,2	34401-12	34402-12	34403-12
1,3	34401-13	34402-13	34403-13
1,4	34401-14	34402-14	34403-14
1,5	34401-15	34402-15	34403-15
1,6	34401-16	34402-16	34403-16
1,7	34401-17	34402-17	34403-17
1,8	34401-18	34402-18	34403-18
1,9	34401-19	34402-19	34403-19
2,0	34401-20	34402-20	34403-20
2,2	34401-22	34402-22	34403-22
2,3	34401-23	34402-23	34403-23
2,4	34401-24	34402-24	34403-24
2,5	34401-25	34402-25	34403-25
2,8	34401-28	34402-28	34403-28
3,0	34401-30	34402-30	34403-30

Kirschner  
mit rundem Ende / with round shaft  
con extremo redondo / con extremo rotondo

Trokarspitze / Trocar point  
Punta trocar / Punte trequarti



Ø	10 cm, 4"	15 cm, 6"	31 cm, 12 1/4"
0,8	34404-08	34405-08	34406-08
0,9	34404-09	34405-09	34406-09
1,0	34404-10	34405-10	34406-10
1,1	34404-11	34405-11	34406-11
1,2	34404-12	34405-12	34406-12
1,3	34404-13	34405-13	34406-13
1,4	34404-14	34405-14	34406-14
1,5	34404-15	34405-15	34406-15
1,6	34404-16	34405-16	34406-16
1,7	34404-17	34405-17	34406-17
1,8	34404-18	34405-18	34406-18
1,9	34404-19	34405-19	34406-19
2,0	34404-20	34405-20	34406-20
2,2	34404-22	34405-22	34406-22
2,3	34404-23	34405-23	34406-23
2,4	34404-24	34405-24	34406-24
2,5	34404-25	34405-25	34406-25
2,8	34404-28	34405-28	34406-28
3,0	34404-30	34405-30	34406-30

Kirschner  
mit flachem Ende / with flat shaft  
con extremo plano / con extremo piatto

Trokarspitze / Trocar point  
Punta trocar / Punte trequarti



Ø	10 cm, 4"	15 cm, 6"	31 cm, 12 1/4"
0,8	34407-08	34408-08	34409-08
0,9	34407-09	34408-09	34409-09
1,0	34407-10	34408-10	34409-10
1,1	34407-11	34408-11	34409-11
1,2	34407-12	34408-12	34409-12
1,3	34407-13	34408-13	34409-13
1,4	34407-14	34408-14	34409-14
1,5	34407-15	34408-15	34409-15
1,6	34407-16	34408-16	34409-16
1,7	34407-17	34408-17	34409-17
1,8	34407-18	34408-18	34409-18
1,9	34407-19	34408-19	34409-19
2,0	34407-20	34408-20	34409-20
2,2	34407-22	34408-22	34409-22
2,3	34407-23	34408-23	34409-23
2,4	34407-24	34408-24	34409-24
2,5	34407-25	34408-25	34409-25
2,8	34407-28	34408-28	34409-28
3,0	34407-30	34408-30	34409-30

Kirschner  
Trokarende / Trocar shaft  
Punta trocar / Punte trequarti Bilaterali

Lanzenspitze / Lance point  
Punta lanceolar / Punte lanceolata



Ø	31 cm, 12 1/4"
0,8	34410-08
0,9	34410-09
1,0	34410-10
1,1	34410-11
1,2	34410-12
1,3	34410-13
1,4	34410-14
1,5	34410-15
1,6	34410-16
1,7	34410-17
1,8	34410-18
1,9	34410-19
2,0	34410-20
2,2	34410-22
2,3	34410-23
2,4	34410-24
2,5	34410-25
2,8	34410-28
3,0	34410-30

Kirschner  
mit flachem Ende / with flat shaft  
con extremo plano / con extremo piatto

lieferbar in Packungen à 10 Stück  
available in packages of 10 pieces  
disponible en paquetetes de 10 unidades  
disponibili solo in confezioni da 10 pezzi

Bohrdrähte, Knochennägel  
Drill Wires, Fracture pins  
Alambres, Clavos para huesos  
Perforatori filiformi, Chiodi per ossa

Lanzenspitze / Lance point  
Punta lanceolar / Punta lanceolata



Ø	31 cm, 12 1/4"
0,8	34411-08
0,9	34411-09
1,0	34411-10
1,1	34411-11
1,2	34411-12
1,3	34411-13
1,4	34411-14
1,5	34411-15
1,6	34411-16
1,7	34411-17
1,8	34411-18
1,9	34411-19
2,0	34411-20
2,2	34411-22
2,3	34411-23
2,4	34411-24
2,5	34411-25
2,8	34411-28
3,0	34411-30

Trokarspitze / Trocar point  
Punta trocar / Punta trequarti



	Ø	Ø	Ø	Ø	Ø	Ø	Ø
	3,5 mm	4,0 mm	4,5 mm	4,8 mm	5,0 mm	5,5 mm	6,0 mm
8 cm, 3 1/8"	34412-08	34413-08	34415-08	34416-08	34417-08	34418-08	34419-08
10 cm, 4"	34412-10	34413-10	34415-10	34416-10	34417-10	34418-10	34419-10
12 cm, 4 3/4"	34412-12	34413-12	34415-12	34416-12	34417-12	34418-12	34419-12
14 cm, 5 1/2"	34412-14	34413-14	34415-14	34416-14	34417-14	34418-14	34419-14
16 cm, 6 1/4"	34412-16	34413-16	34415-16	34416-16	34417-16	34418-16	34419-16
18 cm, 7"	34412-18	34413-18	34415-18	34416-18	34417-18	34418-18	34419-18
20 cm, 8"	34412-20	34413-20	34415-20	34416-20	34417-20	34418-20	34419-20
22 cm, 8 3/4"	34412-22	34413-22	34415-22	34416-22	34417-22	34418-22	34419-22
23 cm, 9"	34412-23	34413-23	34415-23	34416-23	34417-23	34418-23	34419-23
24 cm, 9 1/2"	34412-24	34413-24	34415-24	34416-24	34417-24	34418-24	34419-24
26 cm, 10 1/4"	34412-26	34413-26	34415-26	34416-26	34417-26	34418-26	34419-26
28 cm, 11"	34412-28	34413-28	34415-28	34416-28	34417-28	34418-28	34419-28
30 cm, 11 3/4"	34412-30	34413-30	34415-30	34416-30	34417-30	34418-30	34419-30

Kirschner  
mit rundem Ende / with round shaft  
con extremo redondo / con extremo rotondo

Steinmann  
mit rundem Ende / with round shaft  
con extremo redondo / con extremo rotondo

Trokarspitze / Trocar point  
Punta trocar / Punta trequarti



	Ø	Ø	Ø	Ø	Ø	Ø	Ø	Ø
	3,5 mm	4,0 mm	4,2 mm	4,5 mm	4,8 mm	5,0 mm	5,5 mm	6,0 mm
8 cm, 3 1/8"	34420-08	34421-08	34422-08	34423-08	34424-08	34425-08	34426-08	34427-08
10 cm, 4"	34420-10	34421-10	34422-10	34423-10	34424-10	34425-10	34426-10	34427-10
12 cm, 4 3/4"	34420-12	34421-12	34422-12	34423-12	34424-12	34425-12	34426-12	34427-12
14 cm, 5 1/2"	34420-14	34421-14	34422-14	34423-14	34424-14	34425-14	34426-14	34427-14
16 cm, 6 1/4"	34420-16	34421-16	34422-16	34423-16	34424-16	34425-16	34426-16	34427-16
18 cm, 7"	34420-18	34421-18	34422-18	34423-18	34424-18	34425-18	34426-18	34427-18
20 cm, 8"	34420-20	34421-20	34422-20	34423-20	34424-20	34425-20	34426-20	34427-20
22 cm, 8 3/4"	34420-22	34421-22	34422-22	34423-22	34424-22	34425-22	34426-22	34427-22
23 cm, 9"	34420-23	34421-23	34422-23	34423-23	34424-23	34425-23	34426-23	34427-23
24 cm, 9 1/2"	34420-24	34421-24	34422-24	34423-24	34424-24	34425-24	34426-24	34427-24
26 cm, 10 1/4"	34420-26	34421-26	34422-26	34423-26	34424-26	34425-26	34426-26	34427-26
28 cm, 11"	34420-28	34421-28	34422-28	34423-28	34424-28	34425-28	34426-28	34427-28
30 cm, 11 3/4"	34420-30	34421-30	34422-30	34423-30	34424-30	34425-30	34426-30	34427-30

Steinmann  
Trokarende / Trocar shaft  
Punta trocar / Punta trequarti Bilateralial

Knochennägel  
Fracture pins  
Clavos para huesos  
Chiodi per ossa

lieferbar in Packungen à 10 Stück  
available in packages of 10 pieces  
disponible en paquets de 10 unidades  
disponibili solo in confezioni da 10 pezzi

Trokarspitze / Trocar point  
Punta trocar / Punta trequarti



	Ø	Ø	Ø	Ø	Ø	Ø	Ø	Ø
8 cm, 3 1/8"	3,5 mm	4,0 mm	4,2 mm	4,5 mm	4,8 mm	5,0 mm	5,5 mm	6,0 mm
10 cm, 4"	34428-08	34429-08	34430-08	34431-08	34432-08	34433-08	34434-08	34435-08
12 cm, 4 3/4"	34428-10	34429-10	34430-10	34431-10	34432-10	34433-10	34434-10	34435-10
14 cm, 5 1/2"	34428-12	34429-12	34430-12	34431-12	34432-12	34433-12	34434-12	34435-12
16 cm, 6 1/4"	34428-14	34429-14	34430-14	34431-14	34432-14	34433-14	34434-14	34435-14
18 cm, 7"	34428-16	34429-16	34430-16	34431-16	34432-16	34433-16	34434-16	34435-16
20 cm, 8"	34428-18	34429-18	34430-18	34431-18	34432-18	34433-18	34434-18	34435-18
22 cm, 8 3/4"	34428-20	34429-20	34430-20	34431-20	34432-20	34433-20	34434-20	34435-20
23 cm, 9"	34428-22	34429-22	34430-22	34431-22	34432-22	34433-22	34434-22	34435-22
24 cm, 9 1/2"	34428-23	34429-23	34430-23	34431-23	34432-23	34433-23	34434-23	34435-23
26 cm, 10 1/4"	34428-24	34429-24	34430-24	34431-24	34432-24	34433-24	34434-24	34435-24
28 cm, 11"	34428-26	34429-26	34430-26	34431-26	34432-26	34433-26	34434-26	34435-26
30 cm, 11 3/8"	34428-28	34429-28	34430-28	34431-28	34432-28	34433-28	34434-28	34435-28
	34428-30	34429-30	34430-30	34431-30	34432-30	34433-30	34434-30	34435-30

Steinmann  
mit 3-kant-Ende / with triangular end  
con extremo triangular / con estremo triangolare

Trokarspitze / Trocar point  
Punta trocar / Punta trequarti



mit Gewinde threaded Wires con rosca con filetto	Ø	15 cm, 6"	18 cm, 7"	20 cm, 8"	23 cm, 9"	25 cm, 10"	31 cm, 12 1/4"
	1,2	34436-12	34437-12	34438-12	34439-12	34440-12	34441-12
	1,4	34436-14	34437-14	34438-14	34439-14	34440-14	34441-14
	1,6	34436-16	34437-16	34438-16	34439-16	34440-16	34441-16
	1,8	34436-18	34437-18	34438-18	34439-18	34440-18	34441-18
	2,0	34436-20	34437-20	34438-20	34439-20	34440-20	34441-20
	2,4	34436-24	34437-24	34438-24	34439-24	34440-24	34441-24
	2,5	34436-25	34437-25	34438-25	34439-25	34440-25	34441-25
	2,8	34436-28	34437-28	34438-28	34439-28	34440-28	34441-28
	3,0	34436-30	34437-30	34438-30	34439-30	34440-30	34441-30
	3,2	34436-32	34437-32	34438-32	34439-32	34440-32	34441-32
	3,5	34436-35	34437-35	34438-35	34439-35	34440-35	34441-35

mit rundem Ende / with round shaft  
con extremo redondo / con estremo rotondo

lieferbar in Packungen à 10 Stück  
 available in packages of 10 pieces  
 disponible en paquets de 10 unidades  
 disponibili solo in confezioni da 10 pezzi

Knochennägel  
 Fracture pins  
 Clavos para huesos  
 Chiodi per ossa

Trokarspitze / Trocar point  
 Punta trocar / Punta trequarti

mit Gewinde  
 threaded Wires  
 con rosca  
 con filetto



Ø	15 cm, 6"	18 cm, 7"	20 cm, 8"	23 cm, 9"	25 cm, 10"	31 cm, 12 1/4"
1,2	34442-12	34443-12	34444-12	34445-12	34446-12	34447-12
1,4	34442-14	34443-14	34444-14	34445-14	34446-14	34447-14
1,6	34442-16	34443-16	34444-16	34445-16	34446-16	34447-16
1,8	34442-18	34443-18	34444-18	34445-18	34446-18	34447-18
2,0	34442-20	34443-20	34444-20	34445-20	34446-20	34447-20
2,4	34442-24	34443-24	34444-24	34445-24	34446-24	34447-24
2,5	34442-25	34443-25	34444-25	34445-25	34446-25	34447-25
2,8	34442-28	34443-28	34444-28	34445-28	34446-28	34447-28
3,0	34442-30	34443-30	34444-30	34445-30	34446-30	34447-30
3,2	34442-32	34443-32	34444-32	34445-32	34446-32	34447-32
3,5	34442-35	34443-35	34444-35	34445-35	34446-35	34447-35

Trokarende / Trocar shaft  
 Punta trocar / Punta trequarti



# MAST.SH-GERMANY

Bohrdrahtspender  
 K-Wire Dispenser  
 Dispensador para brocas filiformes  
 Distributore per fili

12 cm, 4 3/4"



17 cm, 6 3/4"



33 cm, 13"



- 34450-08 0,8 mm
- 34450-10 1,0 mm
- 34450-12 1,2 mm
- 34450-14 1,4 mm
- 34450-15 1,5 mm
- 34450-18 1,8 mm
- 34450-20 2,0 mm
- 34450-22 2,2 mm
- 34450-25 2,5 mm
- 34450-30 3,0 mm

- 34460-08 0,8 mm
- 34460-10 1,0 mm
- 34460-12 1,2 mm
- 34460-14 1,4 mm
- 34460-15 1,5 mm
- 34460-16 1,6 mm
- 34460-20 2,0 mm
- 34460-22 2,2 mm
- 34460-25 2,5 mm
- 34460-30 3,0 mm

- 34470-08 0,8 mm
- 34470-10 1,0 mm
- 34470-12 1,2 mm
- 34470-14 1,4 mm
- 34470-15 1,5 mm
- 34470-16 1,6 mm
- 34470-20 2,0 mm
- 34470-22 2,2 mm
- 34470-25 2,5 mm
- 34470-30 3,0 mm

Fingerschützer, Drahtgeflecht  
Finger Protectors, Wire gauze  
Dedales, Gasa metálica  
Proteggidita, maglia metallica per estensione



34480-01



34480-02



34480-03

LANGENBECK  
34480-01 - 34480-03



34492-01  
klein / small / pequeño / stretto

34492-02  
mittel / medium / mediano / medio

34492-03  
groß / large / grande / grande

34492-01 - 34492-03

sterilisierbar  
sterilizable  
esterilizabile  
sterilizzabile

Extensionsbügel  
 Extension Bows  
 Estribos para extensión  
 Archi per estensione

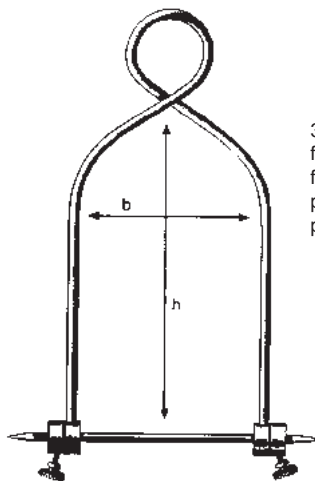

34502-16  
 für Arm  
 for arm  
 para brazo  
 per braccio

16 x 9 cm  
 6 1/4" x 3 1/2"

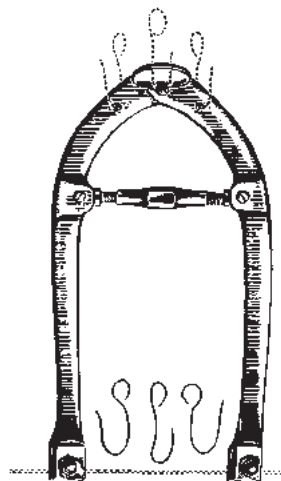

KIRSCHNER

**BÖHLER**  
 34502-15 21 x 15 cm 8 1/4" x 6"  
 34502-21 21 x 11 cm 8 1/4" x 4 3/8"  
 für Oberschenkel und Knie  
 for thigh and knee  
 para femur y rodilla  
 per femore e ginocchio

34514-18 40 - 140 mm x 115 mm mit 3 Zughaken  
 with 3 hooks  
 con 3 ganchos  
 con 3 ganci per trazione

34514-27 60 - 220 mm x 175 mm mit 3 Zughaken  
 with 3 hooks  
 con 3 ganchos  
 con 3 ganci per trazione

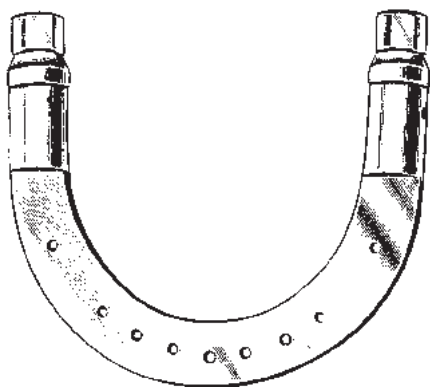

KIRSCHNER

34515-09 9,5 x 7,0 cm 3 3/4" x 2 3/4"  
 34515-10 9,5 x 11,0 cm 3 3/4" x 4 3/8"  
 34515-11 10,5 x 10,0 cm 4.1" x 4"  
 34515-12 12,0 x 12,0 cm 4 3/4" x 4 3/4"  
 34515-13 13,5 x 13,0 cm 5 1/4" x 5 1/8"  
 34515-15 15,5 x 15,5 cm 6" x 6"  
 34515-20 20,0 x 15,5 cm 8" x 6"

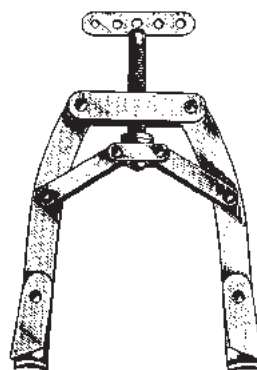

KIRSCHNER U.S.

34518-01  
 mittel, medium, mediano, max. 130 mm (5 1/8")  
 34518-02  
 groß, large, grande, grande, max. 185 mm (7 1/4")  
 34518-03  
 extra groß, large extra long, muy grande, max. 220 mm (8 3/4")





Mutterschlüssel, Spanschlüssel  
Screw nut wrench, Wire strainer  
llave de tuercas, Tensor de taladros, alambres  
Chiave per madreviti, Strumenti tenditore



34515-01

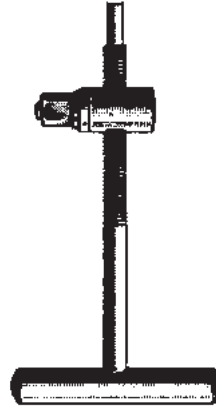

34515-02

Zughaken  
hooks  
ganchos  
ganci per trazione



KIRSCHNER  
34519-01



KIRSCHNER  
34519-02

Knochendraht  
Bone wire  
Hilos para huesos  
Filo per ossa

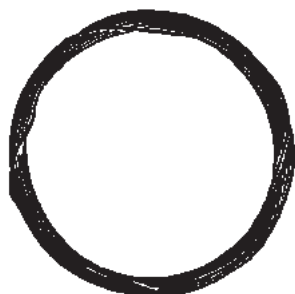

weich, in Ringen zu 10 m (32,8 Feet)  
soft, in coils of 10 m (32,8 Feet)  
blando, de 10 m (32,8 Feet)  
morbido, 10 m (32,8 Feet)

Material:  
nichtrostender Implantatstahl  
nach DIN 17443 (ISO 5832/1)

	mm Ø
34520-02	0,2
34520-03	0,3
34520-04	0,4
34520-05	0,5
34520-06	0,6
34520-07	0,7
34520-08	0,8
34520-09	0,9
34520-10	1,0
34520-12	1,2
34520-15	1,5



Drahtumföhrungsnadeln, Drahtspanninstrumente  
Bone wire guides, Bone wire tighteners  
Agujas pasa-hilos, Tensor cierra-hilos  
Aghi passafili, Strumenti tendifili



DEMEL

27 cm, 10 1/2"

Fig. 1 34528-01

Fig. 2 34528-02

Fig. 3 34528-03

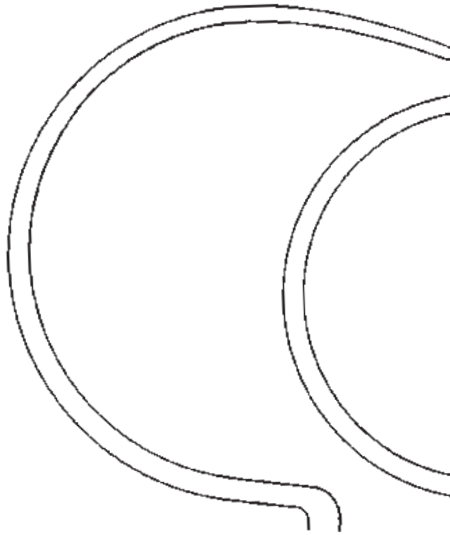

Fig. 1



Fig. 2

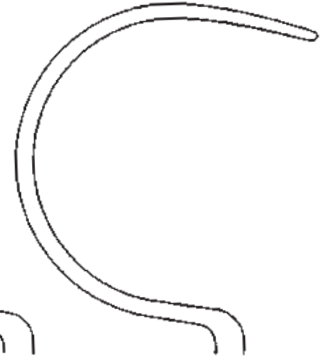
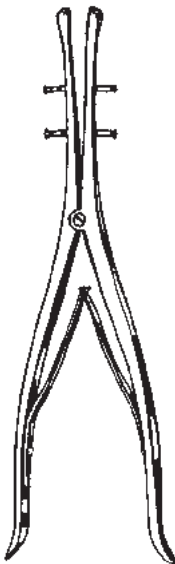
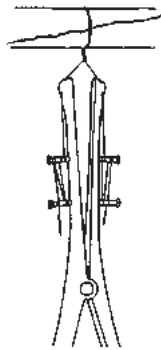

Fig. 3



DEMEL

34530-28 28 cm, 11"



LOUTE

34531-21 21 cm, 8 1/4"

Flachzangen, Faßzangen  
 Flat Nose Pliers, Seizing Forceps  
 Alicates planos, Pinzas para coger alambres  
 Tenaglie piatte, Tenaglie per afferrare



17 cm, 6 3/4"  
 34533-17 INOX



GRIP  
 18 cm, 7"  
 34534-18 INOX



34534-15  
 15 cm, 6"



34535-16  
 16 cm, 6 1/4"

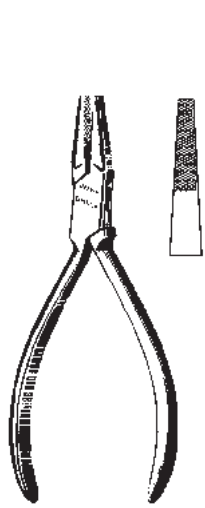

34536-14  
 14 cm, 5 1/2"



34537-19  
 19 cm, 7 1/2"



18 cm, 7"

34538-01 34538-02 34538-03  
 34539-01 TC 34539-02 TC 34539-03 TC

Flachzangen, Drahtkneifzangen  
 Flat Nose Pliers, Wire cutting Pliers  
 Alicates planos, Alicates para cortar alambres  
 Tenaglie piate, Tenaglie tagliafili



34540-01



34540-02



17 cm, 6 3/4"

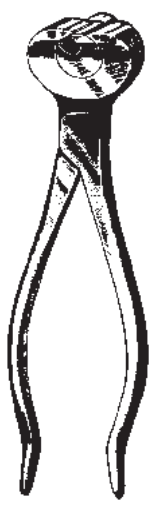

34540-16  
 16 cm, 6 1/4"  
 soft wire 2,0 mm  
 hard wire 2,0 mm



D



34540-18  
 18 cm, 7"



34541-23 23 cm, 9"  
 soft wire 3,0 mm  
 hard wire 2,2 mm

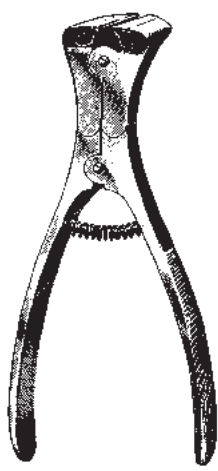

34542-15 TC 15 cm, 6"

Soft wire 2,0 mm  
 hard wire 1,5 mm



34543-23 23 cm, 9"

Soft wire 3,5 mm  
 hard wire 2,5 mm



34544-18 TC 18 cm, 7"

Soft wire 2,5 mm  
 hard wire 1,5 mm

Drahtkneifzangen, Drahtfaßzangen  
 Wire Cutting Pliers, Wire Seizing Forceps  
 Alicates para cortar alambres, Pinzas para coger alambres  
 Tronchese taglienti, Tenaglie per afferrare i fili



für harten Draht bis  
 2,2 mm Ø  
 for hard wires up to  
 2,2 mm Ø  
 para hilos duros  
 hasta 2,2 mm Ø  
 per fili duri a  
 2,2 mm Ø

für weichen Draht bis  
 2,5 mm Ø  
 for soft wires up to  
 2,5 mm Ø  
 para hilos blandos  
 hasta 2,5 mm Ø  
 per fili dolci fino a  
 2,5 mm Ø

34545-22 TC 22 cm, 10 1/2"

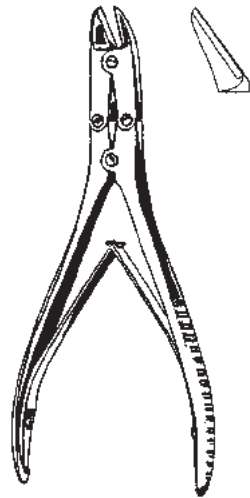

für harten Draht bis 1,6 mm Ø  
 for hard wires up to 1,6 mm Ø  
 para hilos duros hasta 1,6 mm Ø  
 per fili duri a 1,6 mm Ø

für weichen Draht bis 2,0 mm Ø  
 for soft wires up to 2,0 mm Ø  
 para hilos blandos hasta 2,0 mm Ø  
 per fili dolci fino a 2,0 mm Ø

34546-16 16 cm, 6 1/4"  
 34546-18 18 cm, 7"



für weichen Draht bis  
 2,0 mm Ø  
 for soft wires up to  
 2,0 mm Ø  
 para hilos blandos  
 hasta 2,0 mm Ø  
 per fili dolci fino a  
 2,0 mm Ø

für harten Draht bis  
 1,6 mm Ø  
 for hard wires up to  
 1,6 mm Ø  
 para hilos duros  
 hasta 1,6 mm Ø  
 per fili duri a  
 1,6 mm Ø

34548-18 18 cm, 7"



soft wire 1,5 mm  
 hard wire 1,0 mm

34549-14 14 cm, 5 1/2"



34550-13 13 cm, 5 1/8"  
 34550-18 18 cm, 7"

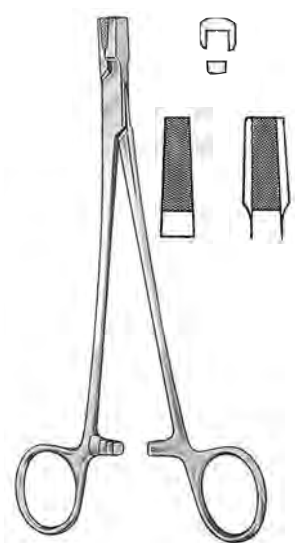

17 cm, 6 3/4"  
 34551-17 TC



Drahtzangen  
Wire Twisting Forceps  
Pinzas para torcer hilos  
Pinza torcifili



CORWIN-HEGAR  
34552-16 TC 16 cm, 6 1/4"



BERRY  
34556-18 TC 18 cm, 7"



MAYO-HABERISSER  
TC

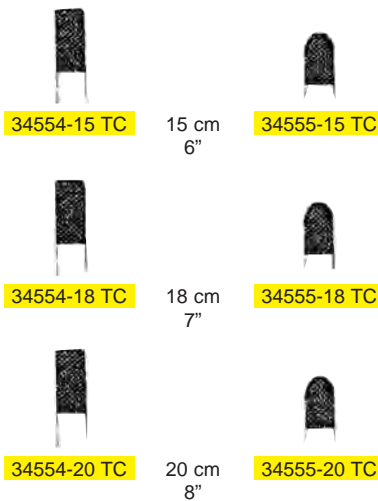

Drahtkneifzange für Draht bis 6 mm Ø  
 Pin cutter for pins up to 6 mm  
 Alicates para cortar clavos hasta 6 mm  
 Ghigliottina per tagliare fili fino a 6 mm



34558-32 32 cm, 12 1/2"

bis 2.2 mm  
 up to 2.2 mm  
 hasta 2.2 mm  
 a 2.2 mm



34559-47 47 cm, 18 1/2"

bis 6 mm  
 up to 6 mm  
 hasta 6 mm  
 a 6 mm



34560-57 57 cm 22 1/2"

bis 6.5 mm  
 up to 6.5 mm  
 hasta 6.5 mm  
 a 6.5 mm





Instrumentarium für Ender und Küntscher Nägel  
Instruments for ender and Küntscher Nails  
Instrumental para Clavos Ender y Küntscher  
Strumentario per chiodi di Ender e Küntscher

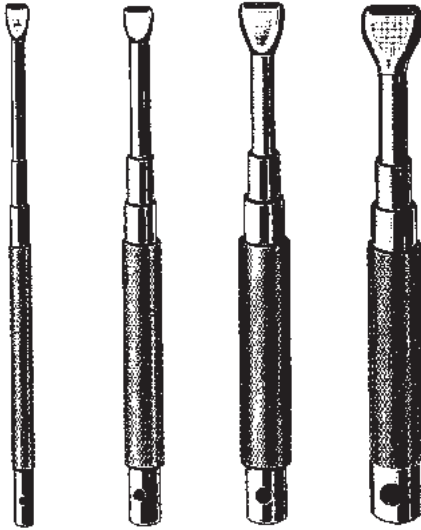

34562-24 f./p. Ø 2,4 mm  
34562-32 3,2 mm  
34562-48 4,8 mm  
34562-64 6,4 mm

Ein- und Ausschlaginstrumente für Ender-Nägel  
Driver-extractors for Ender nails  
Impactores-Extractores para clavos de Ender  
Impattatore-Estrattore per chiodi di Ender

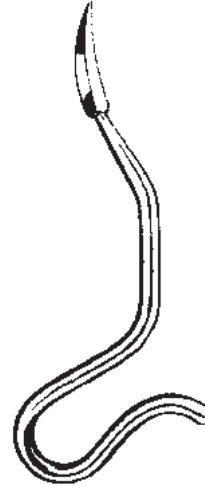

KÜNTSCHER 26 cm, 10 1/4"  
34570-01 8 mm  
34570-02 10 mm

Vorböhrer zum Öffnen der Markhöhle  
Reamers for medullary cave  
Perforadores para la cavidad medular  
Alesatore per l'apertura del midollo



KÜNTSCHER  
34573-35 35 cm, 13 3/4"  
Aufreiber für Oberschenkel  
Reamer for femur  
Perforador para fémur  
Alesatore per femore



mm Ø L = 60 cm, 23 3/4"  
3,5 34583-60  
4,0 34584-60  
5,0 34585-60  
Führungsspieße  
Guide pins  
Guía-conductora para clavos medulares  
Guida conduttrice



für Nägel  
for nails  
para clavos  
per chiodi  
Ø 6-8 mm 34588-01  
Ø 9-12 mm 34588-02  
Ø 12-17 mm 34588-03  
KÜNTSCHER 19 cm, 7 1/2"  
Fertigschläger  
Nail impactors  
Impactor final  
Impattatore finale



# MAST.SH-GERMANY

Instrumentarium für Küntscher Nägel  
 Instruments for Küntscher Nails  
 Instrumental para Clavos Küntscher  
 Strumentario per chiodi di Küntscher

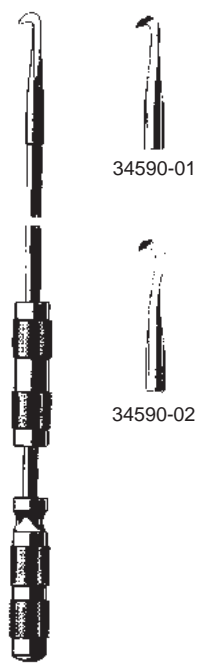

34590-01

34590-02



Extraktionshaken  
 Extraction hooks  
 Ganchos extractores  
 Gancio d'estrazione

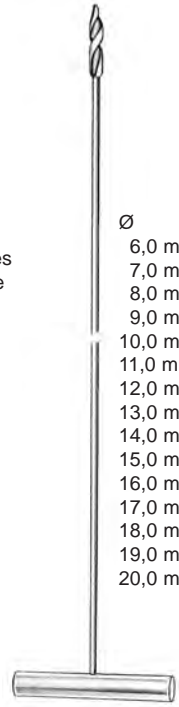

Ø	
6,0 mm	34597-06
7,0 mm	34597-07
8,0 mm	34597-08
9,0 mm	34597-09
10,0 mm	34597-10
11,0 mm	34597-11
12,0 mm	34597-12
13,0 mm	34597-13
14,0 mm	34597-14
15,0 mm	34597-15
16,0 mm	34597-16
17,0 mm	34597-17
18,0 mm	34597-18
19,0 mm	34597-19
20,0 mm	34597-20

KÜNTSCHER	63 cm, 24 3/4"
34590-00 komplett mit 2 Haken	34590-01/02
34590-00 complete with 2 hooks	34590-01/02
34590-00 completo con 2 ganchos	34590-01/02
34590-00 completo con 2 ganci	34590-01/02

	cm
34596-29	29, 11.4"
34596-37	37, 14.5"
34596-42	42, 16.5"
34596-49	49, 19.3"

Markraumbohrer	Intramedullary drills
Perforadores medulares	Perforatore intramidollare

Extraktor / Nail extractor  
 Aparato extractor / Estrattore



Einschläger / Nail inserter  
 Introducitor clavos / Impattore  
 34612-00



Impactor  
 34613-00



Bender  
 34615-00



Impactor-Extractor  
 Impattore-Estrattore  
 34617-00

Schraubenzieher  
Screw Drivers  
Destornilladores  
Cacciaviti



LANE  
34620-25 25 cm, 10"  
Schraubenzieher 6 mm  
Screw Driver 6 mm  
Destornillador 6 mm  
Cacciaviti 6 mm



WILLIAMS  
24 cm  
9 1/2"

3,5 mm



34624-01



34624-02



34624-03



34624-04



mit Ferrozellgriff  
with Ferrozell handle  
con mango de Ferrozell  
con manico di Ferrozell



34628-01  
25 cm  
10"



34628-02  
25 cm  
10"



34629-01  
25 cm  
10"



1,5 mm

34628-15  
20 cm  
8"



2,5 mm

34628-25  
25 cm  
10"



3,5 mm

34628-35  
25 cm  
10"

Schraubenzieher  
Screw Drivers  
Destornilladores  
Cacciaviti



LANE  
34632-25 25 cm, 10"  
Kreuzschlitzschraubenzieher  
Screwdriver for cross slotted head  
Destornillador para tornillos con ranura en cruz  
Cacciavite a croce



Schraubenhaltehülse für Sechskantschrauben  
Screw holder  
Vaina para tornillos  
Guaina per viti esagonali  
34634-25 2,5 mm  
34634-35 3,5 mm



**MAST.SH-GERMANY**

Haltezangen, Biegehebel  
Holding Forceps, Bender  
Pinzas para sostener placas y tornillos, Palanca  
Pinza portaplacca, leva piegaplacche



LANE  
34637-23 23 cm, 9"

Knochenplatten-Haltezange  
Plate Holding Forceps  
Pinza para sostener placas  
Pinza portaplacche



LANE  
34639-22 22 cm, 8 3/4"

Schraubenhaltezange  
Screw Holding Forceps  
Pinza para sostener tornillos  
Pinza portaviti

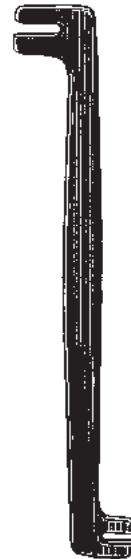

LANE  
34640-18 18 cm, 7"

Biegehebel f. Knochenplatten  
Plate Bender  
Palanca para doblar placas  
Leva piegaplacche



# MAST.SH-GERMANY

Anlegezangen, Silberklammern  
 Applying Fcps. Clips  
 Pinzas aplicadoras, Grapas  
 Pinza per applicare, Agrafes

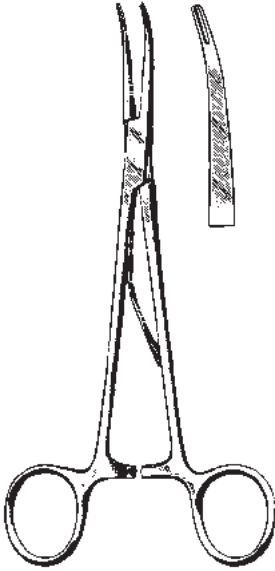

**McKENZIE**  
 41011-15 15 cm, 6"  
 41011-19 19 cm, 7 1/2"

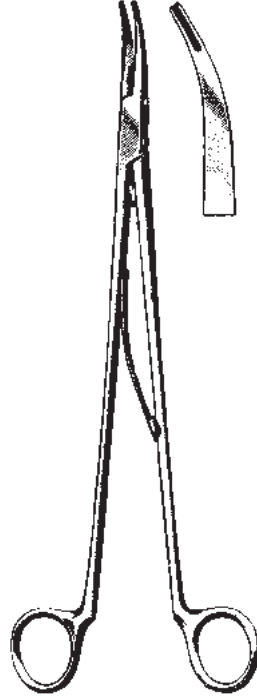

**SMITHWICK**  
 41015-23 23 cm, 9"  
 41015-26 26 cm, 10 1/4"

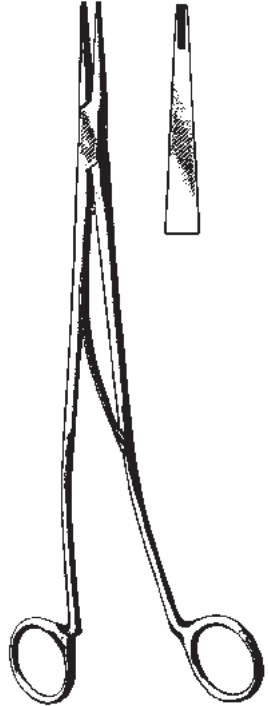

**SWEET**  
 41017-23 23 cm, 9"  
 41017-26 26 cm, 10 1/4"



**OLIVECRONA-TOENNIS**  
 41019-14

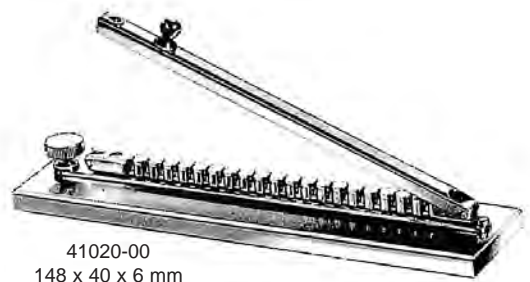

41020-00  
 148 x 40 x 6 mm

Schädelhalter, Kopfhautklammer, Anlegezange  
 Cervical Traction Tongs, Clips, Applying Forceps  
 Pinzas de tracción cranial, Clips, Pinza para aplicar clips  
 Pinze per trazione craniale, Pinza per applicare

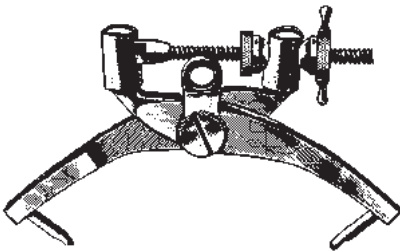

CRUTCHFIELD  
41025-01



CRUTCHFIELD  
41025-02



41026-35  
3,5 mm Ø



41026-50  
5 mm Ø

Stainless steel  
Acciaio inox



RANEY  
41027-00

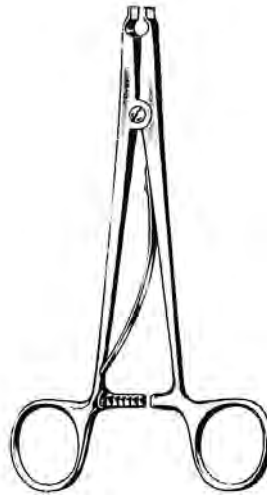

RANEY  
41028-00 16 cm, 6 1/4"

Nervhaken, Durahaken  
 Nerve Hooks, Dura Hooks  
 Ganchos para nervios y para dura-madre  
 Unicini per nervi e per dura-madre



DANDY  
 41051-20  
 20 cm, 8"



DANDY  
 41052-20  
 20 cm, 8"



DANDY  
 41053-20  
 20 cm, 8"



CRILE  
 41054-20  
 20 cm, 8"

Fig. 1



CUSHING  
 41056-18  
 18 cm, 7"

Fig. 2



CUSHING  
 41058-18  
 18 cm, 7"



Nervhaken, Durahaken  
 Nerve Hooks, Dura Hooks  
 Ganchos para nervios y para dura-madre  
 Unicini per nervi e per dura-madre



GRAHAM  
 41061-16  
 16,5 cm, 6 1/2"



SACHS  
 41064-16  
 18,5 cm, 7 1/4"



ADSON  
 41068-20  
 20 cm, 8"



ADSON  
 41069-20  
 20 cm, 8"



SMITHWICK  
 41070-29  
 29 cm, 11.4"



# MAST.SH-GERMANY

Nervwurzelnhaken  
Nerve Root Retractors  
Separadores de raiz de nervios  
Uncini per le radici dei nervi

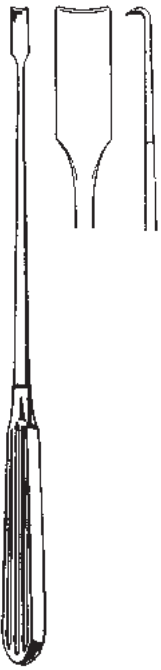

SCOVILLE  
41074-23  
23 cm, 9"



HOLSHER  
41075-24  
24 cm, 9 1/2"

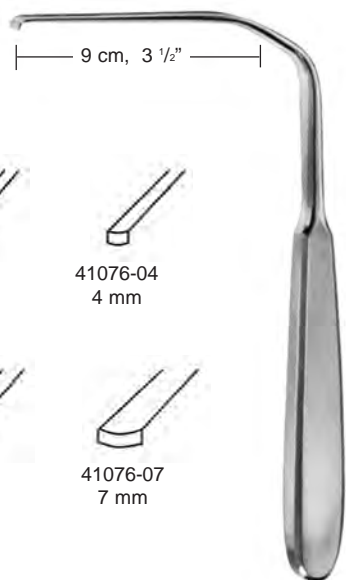

HESS  
17,5 cm, 7"



41076-03  
3 mm



41076-04  
4 mm



41076-05  
5 mm



41076-07  
7 mm



**MAST.SH-GERMANY**

Nervwurzelnhaken  
Nerve Root Retractors  
Separadores de raiz de nervios  
Uncini per le radici dei nervi



D'ERRICO  
41078-23  
23 cm, 9"



LOVE  
41079-21  
21 cm, 8 1/4"



# MAST.SH-GERMANY

Nervwurzelhaken, Galea Haken  
 Nerve Root Retractors, Galea Hooks  
 Separadores de raiz de nervios, Gancho para galea  
 Uncini per le radici dei nervi, Uncini galea

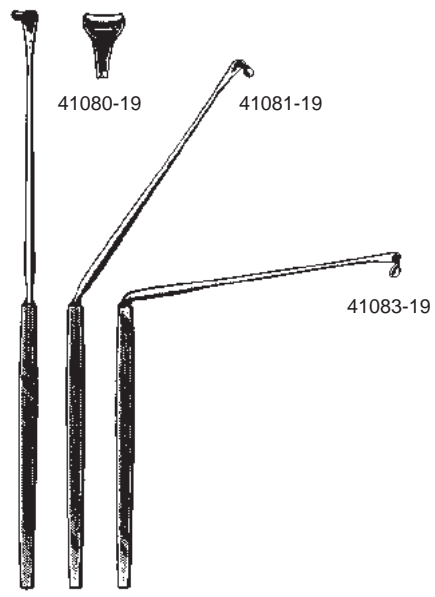

LOVE  
 41080-19 – 41083-19  
 19 cm, 7 1/2"

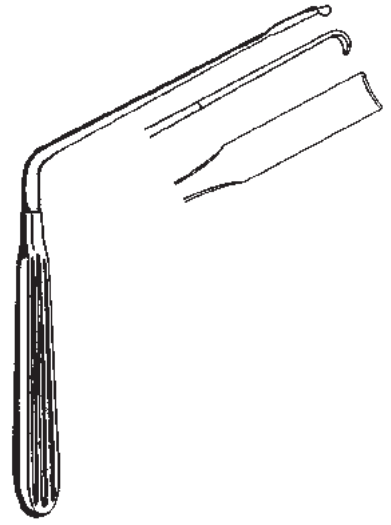

SCOVILLE  
 41085-20  
 20 cm, 8"



DeMARTEL  
 41090-33  
 33 cm, 13"



YASARGIL  
 41091-31  
 31 cm, 12 1/4"

Galeahaken  
 Galea Hooks  
 Gancho p/galea  
 Gancio p/galea

Ø 7 mm



YASARGIL  
 41091-41  
 41 cm, 16"

Ø 9 mm

Schädelstanze  
Cranial Punch  
Pinzas sacabocado craneal  
Pinza per craniotomia



CONE  
41097-22  
22,5 cm 9"



# MAST.SH-GERMANY

Dura Dissektoren, Schädelzange  
 Dura Dissectors, Skull Punches  
 Elevadores para la duramadre, Pinzas sacabocado craneal  
 Scollatori per duramadre, Pinza per craniotomia

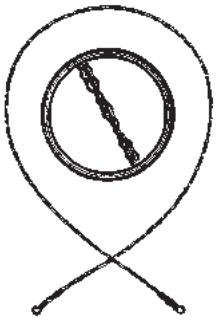

**OLIVECRONA** cm  
 41092-30 30, 11 3/4"  
 41092-40 40, 15 3/4"  
 41092-50 50, 19 3/4"  
 41092-60 60, 23 3/4"  
 41092-70 70, 27 1/2"

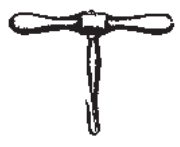

**GIGLI**  
 41094-00



**DeVILBISS**  
 41096-21  
 21 cm, 8 1/4"



**TOENNIS**  
 41141-25  
 25 cm, 10"



**SACHS**  
 41143-21  
 21 cm, 8 1/4"



**SACHS**  
 41145-21  
 21 cm, 8 1/4"



**OLIVECRONA**  
 41146-18 18 cm, 7"  
 41146-24 24 cm, 9 1/2"

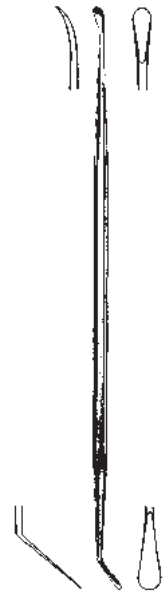

**MILLIGAN**  
 41147-21  
 21 cm, 8 1/4"



41149-22  
 22 cm, 8 3/4"



**DAVIS**  
 41151-24  
 24 cm, 9 1/2"



Dura Dissektoren  
Dura Dissectors  
Elevadores  
Scollatori

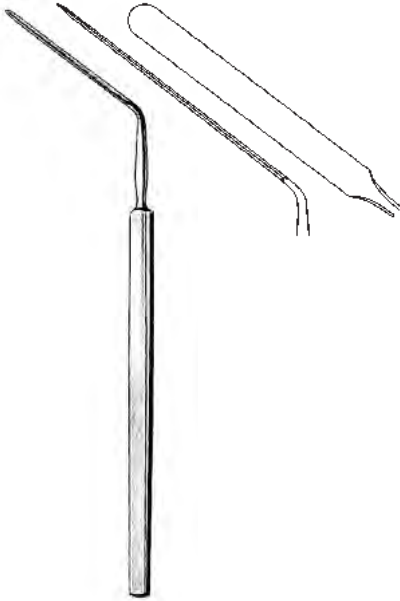

**HORSLEY**  
41155-20  
20 cm, 8"

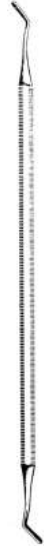

**WOODSON**  
41156-18  
18 cm, 7"



**FRAZIER**  
41158-01  
15 cm, 6"



**HOEN**  
41158-02  
15 cm, 6"

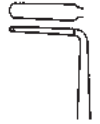

**HOEN**  
41158-03  
15 cm, 6"



**PENFIELD**  
41161-01  
17,5 cm, 6.9"



**PENFIELD**  
41161-02  
19,5 cm, 7 3/4"



**PENFIELD**  
41161-03  
19,5 cm, 7 3/4"



**PENFIELD**  
41161-04  
21,5 cm, 8 1/2"



**PENFIELD**  
41161-05  
29 cm 11.4"



# MAST.SH-GERMANY

Hypophyse Pinzetten, Küretten  
Hypophyseal Forceps, Curette  
Pinzas para hipófisis, Curetas  
Pinze per ipofisi, Curette



ADSON  
41210-23  
23 cm, 9"



ADSON  
41211-23  
23 cm, 9"



ADSON  
41213-23  
23 cm, 9"



41221-00  
19 cm, 7 1/2"



41222-00  
19 cm, 7 1/2"

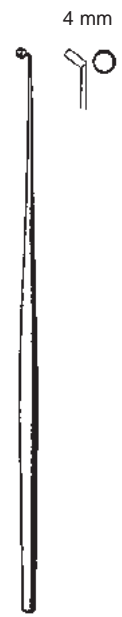

41223-00  
19 cm, 7 1/2"



41224-00  
19 cm, 7 1/2"



Messer, Haken, Sonden  
 Knives, Hooks, Probes  
 Bisturies, Ganchos, Sondas  
 Bisturi, Uncino, Sonde

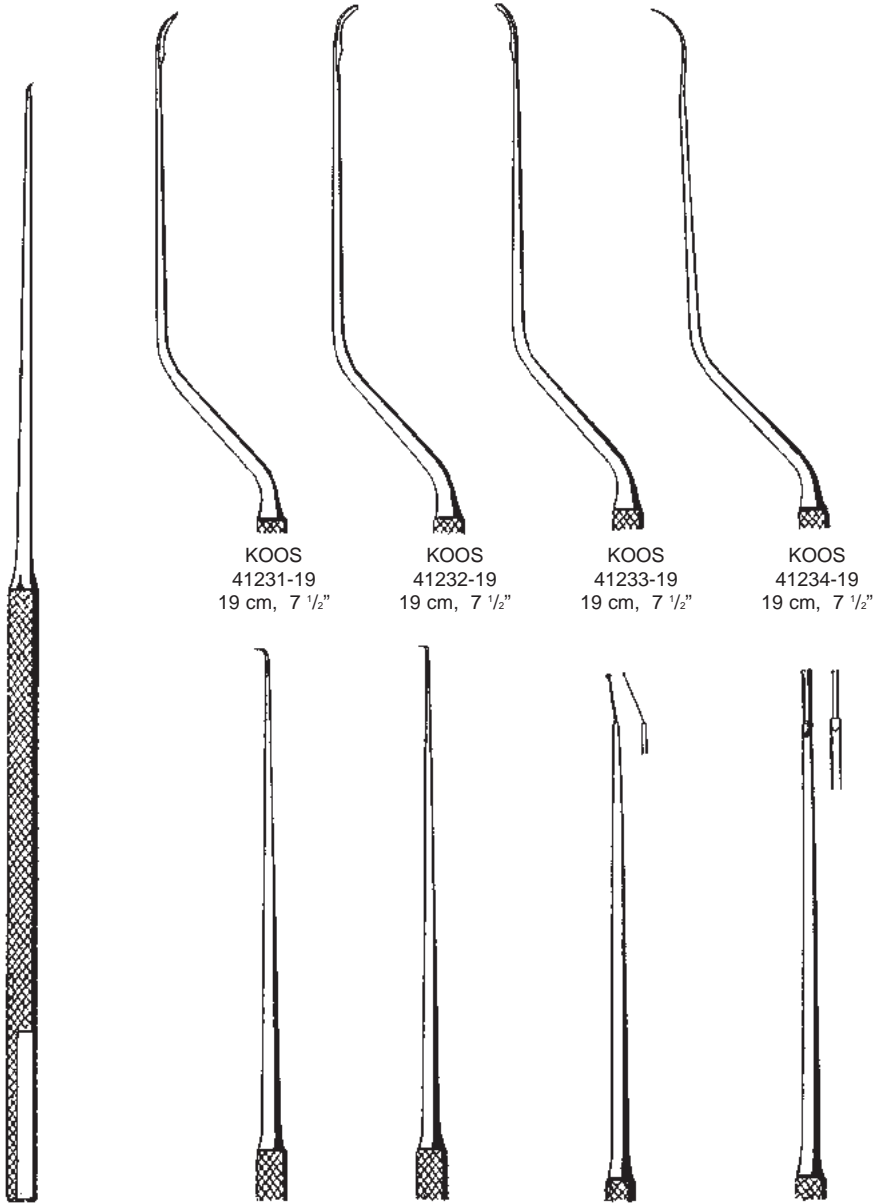

KOOS  
 41231-19  
 19 cm, 7 1/2"

KOOS  
 41232-19  
 19 cm, 7 1/2"

KOOS  
 41233-19  
 19 cm, 7 1/2"

KOOS  
 41234-19  
 19 cm, 7 1/2"

JACOBSON  
 41230-19  
 19 cm, 7 1/2"

41236-19  
 19 cm, 7 1/2"

FISCH  
 41237-19  
 19 cm, 7 1/2"

JACOBSON  
 41238-19  
 19 cm, 7 1/2"

JACOBSON  
 41239-19cm  
 19 cm, 7 1/2"

Durahaken  
 Dura Hook  
 Ganchito para dura-madre  
 Uncino dura madre

Feines Häkchen  
 Delicate Hook  
 Ganchito muy fino  
 Uncino molto fino

Knopfsonde  
 Buttoned Probe  
 Sonda abotonada  
 Sonda bottonuta

Doppelsonde  
 Twin Probe  
 Sonda doble  
 Sonda doppia

Nervhäkchen, Hirnspatel, Saugrohre  
 Nerve Hooks, Brain Spatulas, Suction Tubes  
 Ganchos para nervios, Espatulas cerebrales, Tubos de aspiración  
 Uncini per nervi, Spatole cerebrali, Tubi aspirazioni



KRAYENBÜHL  
 41242-19  
 19 cm, 7 1/2"



KRAYENBÜHL  
 41243-19  
 19 cm, 7 1/2"



KRAYENBÜHL  
 41244-19  
 19 cm, 7 1/2"



KRAYENBÜHL  
 41245-19  
 19 cm, 7 1/2"



CUSHING  
 41250-11 8x10 mm  
 41250-15 13x15 mm  
 41250-18 16x18 mm

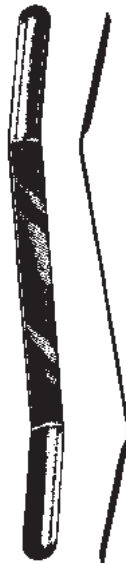

OLIVECRONA mm  
 41253-07 7/ 9  
 41253-11 11/13  
 41253-15 15/18  
 41253-18 18/22



BARON  
 41299-03 3FR 1,0 mm  
 41299-05 5FR 1,6 mm  
 41299-07 7FR 2,3 mm

Hirnspatel, Saugrohre, Punktionskanüle  
 Brain Spatulas, Suction Tubes, Puncture Cannulas  
 Espatulas cerebrales, Tubos de aspiración, Tubo de punción  
 Spatole cerebrali, Tubi aspirazioni, cannula per punzione



biegsam  
 malleable  
 maleable  
 malleabile

DAVIS 18 cm, 7"

41254-06	6 mm, 1/4"
41254-10	9 mm, 3/8"
41254-13	13 mm, 1/2"
41254-16	16 mm, 5/8"
41254-19	19 mm, 3/4"
41254-25	25 mm, 1"
41254-32	32 mm, 1 1/4"
41254-38	38 mm, 1 1/2"



ADSON  
 41290-21  
 21 cm, 8 1/4"  
 ø 4 mm



FERGUSON  
 41294-40  
 18 cm, 7"  
 ø 4 mm, 90°

Charr.		✂
F.G.	30°	75°
6	41295-06	41297-06
7	41295-07	41297-07
8	41295-08	41297-08
9	41295-09	41297-09
10	41295-10	41297-10
11	41295-11	41297-11
12	41295-12	41297-12
15	41295-15	

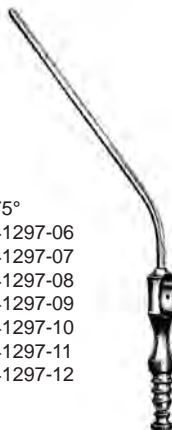

FRAZIER / FERGUSON  
 41295-06 – 41297-12  
 19 cm, 7 1/2"



FRAZIER / FERGUSON  
 41298-12  
 12 cm, 4 3/4" / 3 mm



# MAST.SH-GERMANY

Saugrohre  
 Suction Tubes  
 Tubos de aspiración  
 Tubi aspirazioni

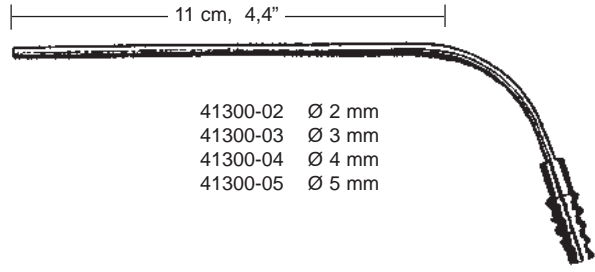

- 41300-02 Ø 2 mm
- 41300-03 Ø 3 mm
- 41300-04 Ø 4 mm
- 41300-05 Ø 5 mm

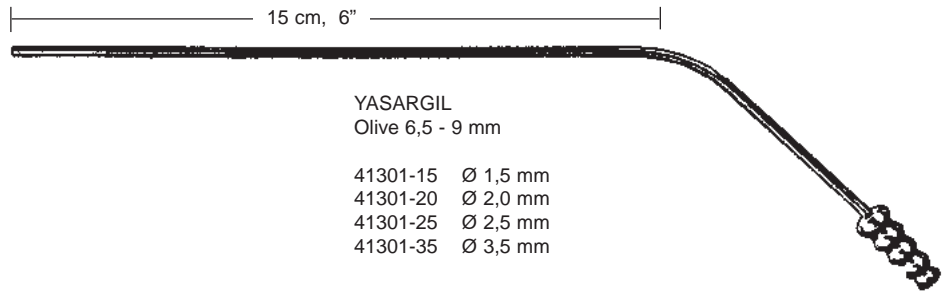

YASARGIL  
 Olive 6,5 - 9 mm

- 41301-15 Ø 1,5 mm
- 41301-20 Ø 2,0 mm
- 41301-25 Ø 2,5 mm
- 41301-35 Ø 3,5 mm



ZÖLLNER  
41302-01



ZÖLLNER  
41302-02



- 0,5 mm Ø 41306-05
- 0,7 mm Ø 41306-07
- 0,9 mm Ø 41306-09
- 1,2 mm Ø 41306-12

Kanüle für Sauggriff für Zöllner und Wullstein  
 Tip for Suction Handle for Zöllner and Wullstein  
 Cánula para mango t Zöllner y Wullstein  
 Cannula per manico di aspirazione t Zöllner e Wullstein



**MAST.SH-GERMANY**

Saugrohre  
Suction Tubes  
Tubos de aspiración  
Tubi aspirazioni

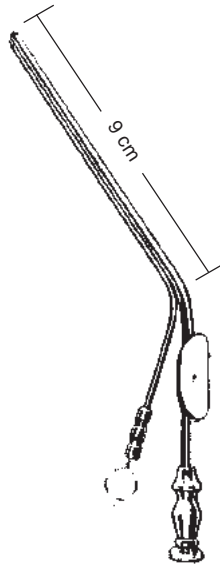

HOUSE

9 cm, 3 1/2"

41303-09	Ø 0,9 x 0,7 mm
41303-12	Ø 1,2 x 0,9 mm
41303-15	Ø 1,5 x 1,2 mm
41303-18	Ø 1,8 x 1,8 mm
41303-25	Ø 2,5 x 2,0 mm
41303-30	Ø 3,0 x 2,0 mm
41303-45	Ø 4,5 x 2,0 mm



# MAST.SH-GERMANY

Saugrohre, Saugkanülen  
 Suction Tubes, Suction Cannulae  
 Tubos de aspiración, Cánulas para aspiración  
 Tubi aspirazioni, Cannule per aspirazione



Sauggriff  
 Suction Handle  
 Mango de aspiración  
 Manico per aspirazione

WULLSTEIN  
 41307-00



Kanüle für Sauggriff  
 Tip for Suction Handle  
 Cánula para mango  
 Cannula per manico di aspirazione

### ROSEN

0,5 mm Ø 41305-05	1,4 mm Ø 41305-14
0,6 mm Ø 41305-06	1,5 mm Ø 41305-15
0,7 mm Ø 41305-07	1,8 mm Ø 41305-18
0,8 mm Ø 41305-08	2,0 mm Ø 41305-20
0,9 mm Ø 41305-09	2,5 mm Ø 41305-25
1,0 mm Ø 41305-10	3,0 mm Ø 41305-30
1,2 mm Ø 41305-12	



Charr. 6 41304-06  
 Charr. 8 41304-08  
 Charr. 10 41304-10

PLESTER  
 30°



biegsam  
 malleable  
 maleable  
 malleabile

SCHMID  
 15 cm, 6"

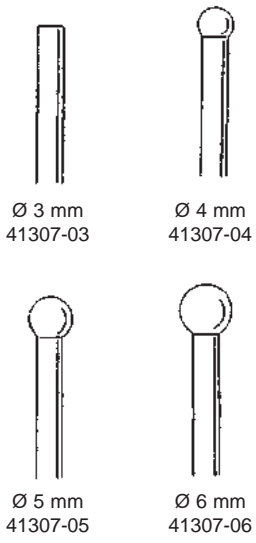

Ø 3 mm  
 41307-03

Ø 4 mm  
 41307-04

Ø 5 mm  
 41307-05

Ø 6 mm  
 41307-06



Wirbelkörperspreizer  
Lamina Spreaders  
Separadores para cuerpos vertebrales  
Divaricatori per corpi vertebrali



CLOWARD  
41401-16

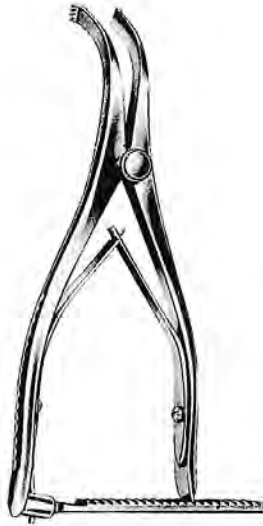

INGE  
41405-17 - 41405-27

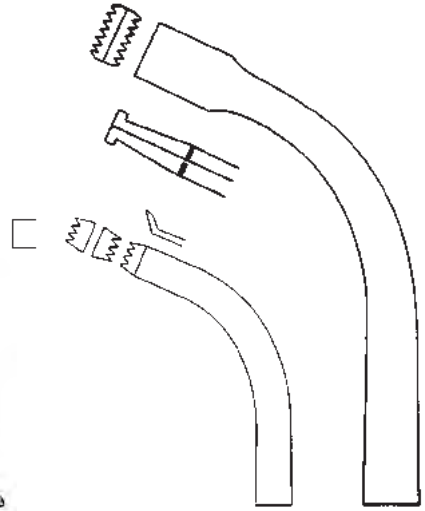

41405-17  
17 cm  
6 3/4"

41405-27  
27 cm  
10 1/2"



19 mm

CLOWARD  
41406-01  
12,5 cm, 5"

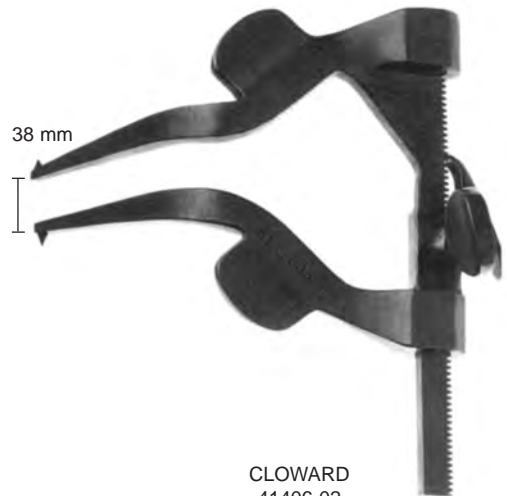

38 mm

CLOWARD  
41406-02  
7,6 cm, 3"

Laminektomie Zangen  
 Laminectomy Rongeurs  
 Pinzas cortantes para laminectomia  
 Pinze taglienti per laminectomia

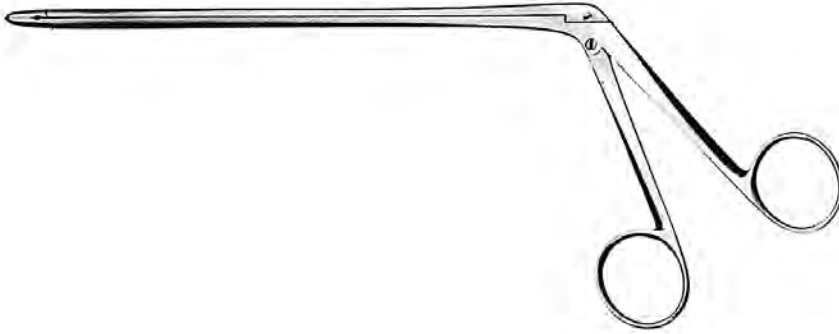

**CUSHING**  
2 mm

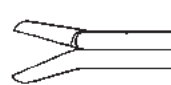

2x10 mm	L	2x10 mm/45°	L	2x10 mm/45°	L
41420-01	12,5 cm	41420-02	12,5 cm	41420-03	12,5 cm
41421-01	15,0 cm	41421-02	15,0 cm	41421-03	15,0 cm
41422-01	18,0 cm	41422-02	18,0 cm	41422-03	18,0 cm

**LOVE-GRUENWALD**  
3 mm

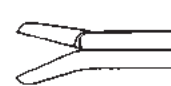

3x10 mm	L	3x10 mm/45°	L	3x10 mm/45°	L
41430-01	12,5 cm	41430-02	12,5 cm	41430-03	12,5 cm
41431-01	15,0 cm	41431-02	15,0 cm	41431-03	15,0 cm
41432-01	18,0 cm	41432-02	18,0 cm	41432-03	18,0 cm

**SPURLING**  
4 mm

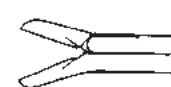

4x10 mm	L	4x10 mm/45°	L	4x10 mm/45°	L
41440-01	12,5 cm	41440-02	12,5 cm	41440-03	12,5 cm
41441-01	15,0 cm	41441-02	15,0 cm	41441-03	15,0 cm
41442-01	18,0 cm	41442-02	18,0 cm	41442-03	18,0 cm





Laminektomie Zangen  
Laminectomy Rongeurs  
Pinzas cortantes para laminectomia  
Pinze taglienti per laminectomia

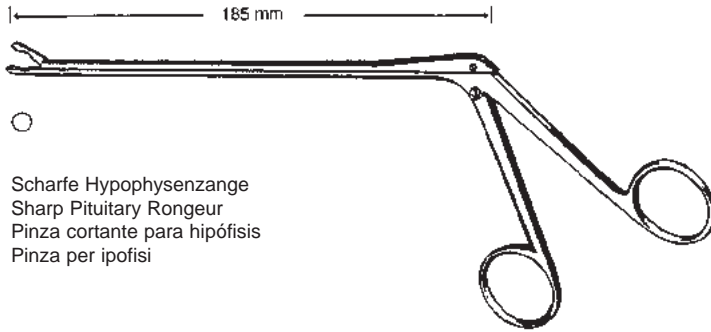

Scharfe Hypophysenzange  
Sharp Pituitary Rongeur  
Pinza cortante para hipofisis  
Pinza per ipofisi

41443-26  
25,5 cm, 10"

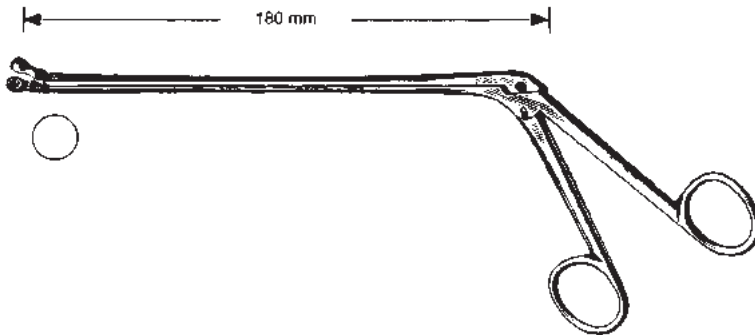

OLDBERG  
41445-25  
25 cm (9.8"), Ø 7 mm

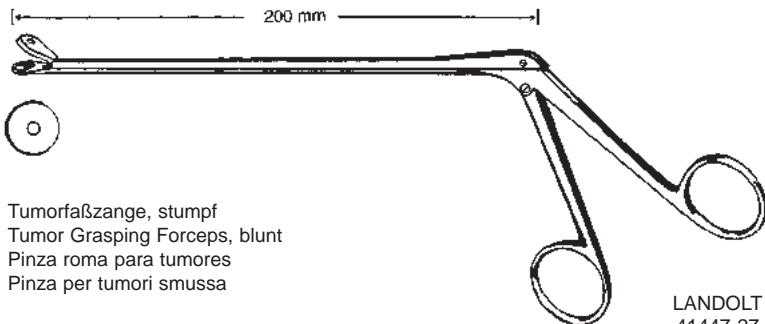

Tumorfalßzange, stumpf  
Tumor Grasping Forceps, blunt  
Pinza roma para tumores  
Pinza per tumori smussa



LANDOLT  
41447-27  
27 cm (10 1/2"), Ø 9 mm



# MAST.SH-GERMANY

Laminektomie Zangen  
 Laminectomy Rongeurs  
 Pinzas cortantes para laminectomia  
 Pinze taglienti per laminectomia

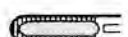
15 cm, 6"

-  2 x 10 mm
-  3 x 10 mm
-  4 x 10 mm

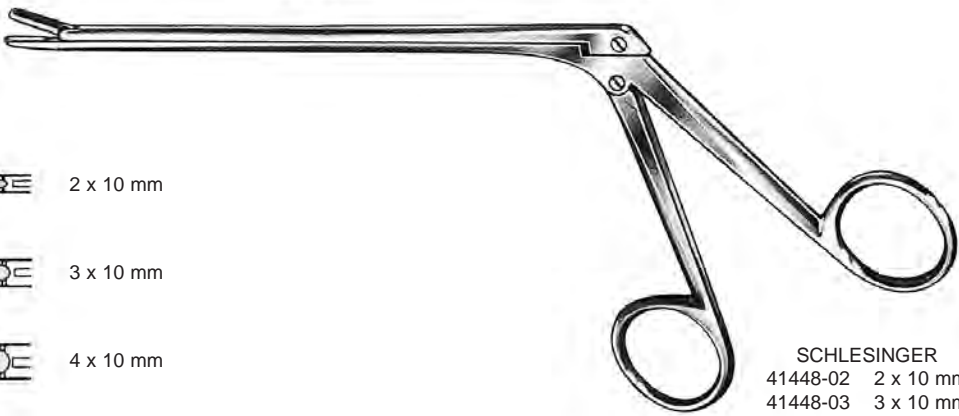

SCHLESINGER  
 41448-02 2 x 10 mm  
 41448-03 3 x 10 mm  
 41448-04 4 x 10 mm

15 cm, 6"

3 x 10 mm



41449-01      41449-02      41449-03

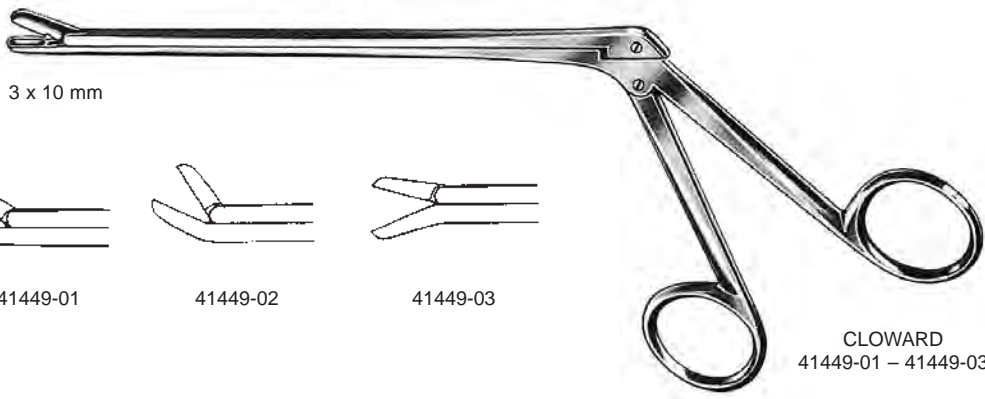

CLOWARD  
 41449-01 – 41449-03

Laminektomie Zangen  
 Laminectomy Rongeurs  
 Pinzas cortantes para laminectomia  
 Pinze taglienti per laminectomia

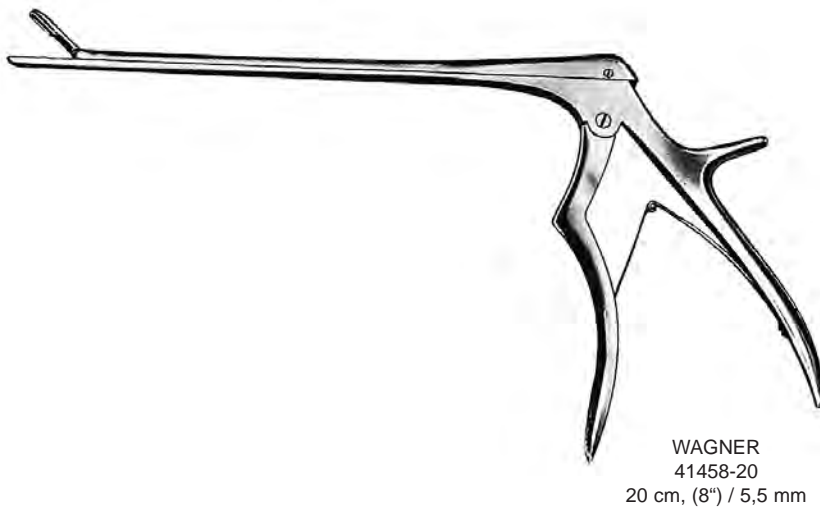
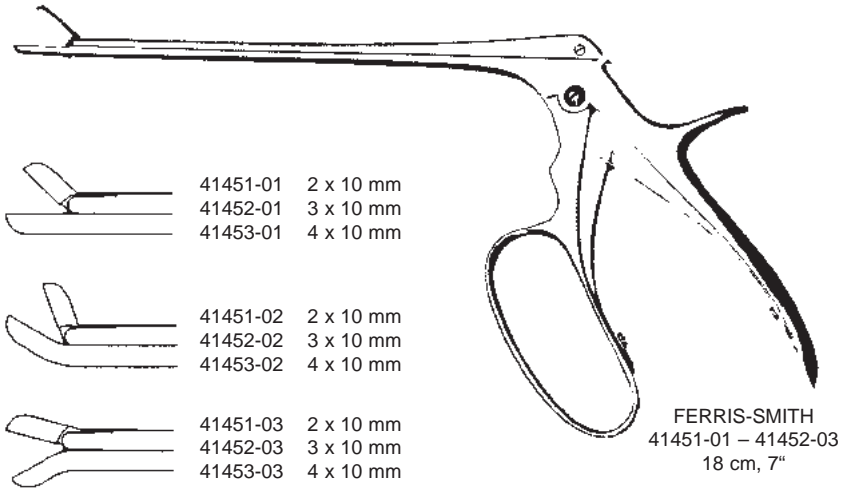



# MAST.SH-GERMANY

Bandscheibenstanzen  
 Intervertebral Disc Rongeurs  
 Pinzas sacabocado para discos intervertebrales  
 Pinze taglienti per dischi intervertebrali

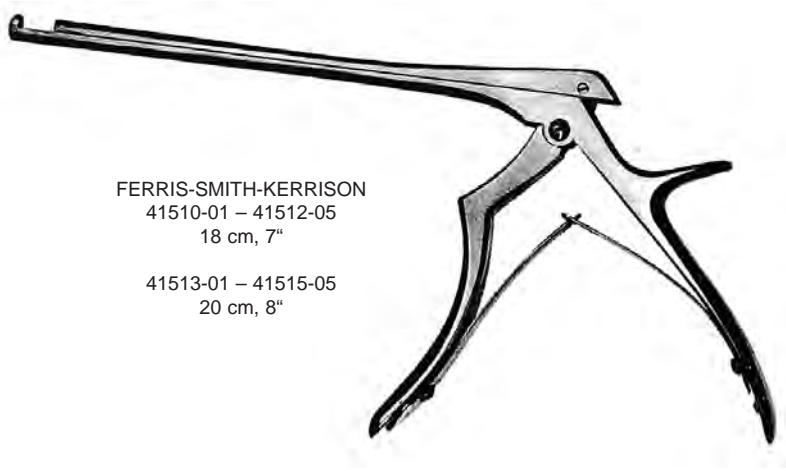

FERRIS-SMITH-KERRISON  
 41510-01 – 41512-05  
 18 cm, 7"  
 41513-01 – 41515-05  
 20 cm, 8"

	90°	90°	40°
18 cm	41510-01 1 mm	41511-01 1 mm	41512-01 1 mm
20 cm	41513-01 1 mm	41514-01 1 mm	41515-01 1 mm
18 cm	41510-02 2 mm	41511-02 2 mm	41512-02 2 mm
20 cm	41513-02 2 mm	41514-02 2 mm	41515-02 2 mm
18 cm	41510-03 3 mm	41511-03 3 mm	41512-03 3 mm
20 cm	41513-03 3 mm	41514-03 3 mm	41515-03 3 mm
18 cm	41510-04 4 mm	41511-04 4 mm	41512-04 4 mm
20 cm	41513-04 4 mm	41514-04 4 mm	41515-04 4 mm
18 cm	41510-05 5 mm	41511-05 5 mm	41512-05 5 mm
20 cm	41513-05 5 mm	41514-05 5 mm	41515-05 5 mm

Bandscheibenstanzen  
 Intervertebral Disc Rongeurs  
 Pinzas sacabocado para discos intervertebrales  
 Pinze taglienti per dischi intervertebrali

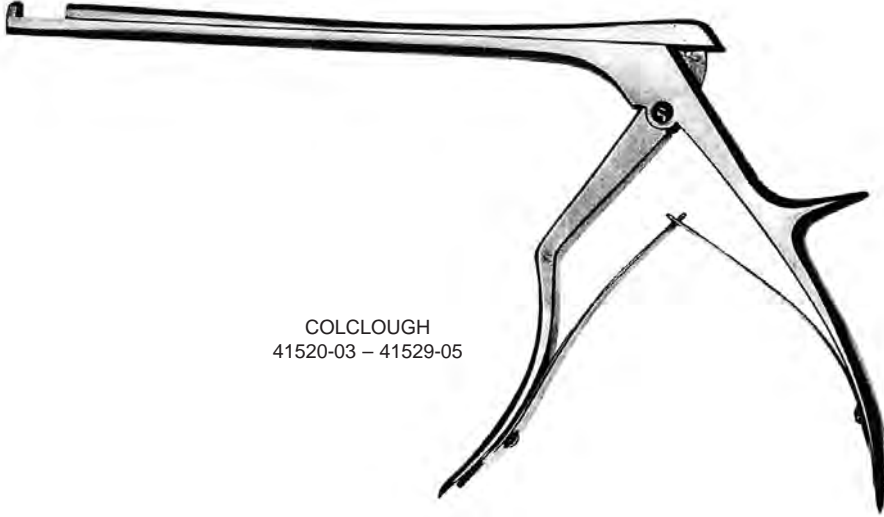

COLCLOUGH  
 41520-03 - 41529-05

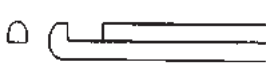

3 mm  
 41520-03 15 cm, 6"  
 41522-03 20 cm, 8"



5 mm  
 41520-05 15 cm, 6"  
 41522-05 20 cm, 8"



3 mm  
 41524-03 15 cm, 6"  
 41526-03 20 cm, 8"

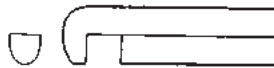

5 mm  
 41524-05 15 cm, 6"  
 41526-05 20 cm, 8"

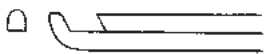

3 mm  
 41527-03 15 cm, 6"  
 41529-03 20 cm, 8"



5 mm  
 41527-05 15 cm, 6"  
 41529-05 20 cm, 8"

Zerlegbare Stanzen  
 Detachable punches  
 Pinzas cortantes desmontables  
 Pinze taglienti e smontabili

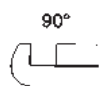
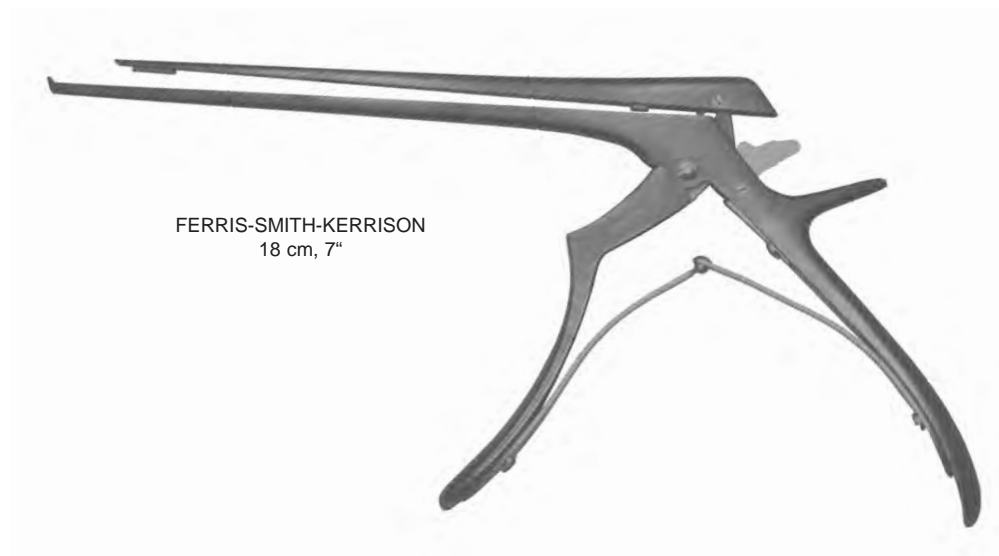

41540-02 2 mm

41540-03 3 mm

41540-04 4 mm

41540-05 5 mm

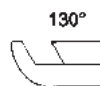

41542-02 2 mm

41542-03 3 mm

41542-04 4 mm

41542-05 5 mm

YASARGIL – Aneurysmen – Gefäß – Clips  
 YASARGIL – Aneurysm – Vessel – Clips  
 YASARGIL – Clips para aneurisma  
 YASARGIL – Clips per aneurisma

aus hochwertigem Implantat-Stahl antimagnetisch  
 in high quality Implant steel antimagnetic  
 de acero inoxidable para implantes de alta calidad, antimagnético  
 Prodotto in acciaio di alta qualità, antimagnetico

## Features of the Clip

### SERIAL-NUMBER

Each clip is coded with an individual serial number – marked by laser technology-  
 The serial number guarantees a detailed follow-up of

- the whole production process
- the closure force
- from raw material to the final product

These informations are registered in our company for the period of 10 years.

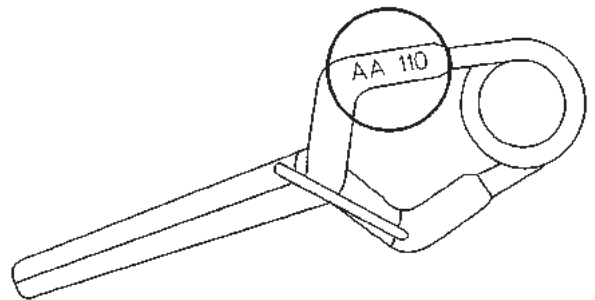

### PACKING – LABELING

Each clip is individually packaged in a transparent box made of resistant plastic.  
 Special wishes of customers regarding the packaging will be considered by us. This will be marked on an internal instruction.

The transparent box is marked with a label in order to assure a quick and sure identification of the clip.

On the label you can find the following data:

- catalogue number
- Product description
- Illustration
- Closing force in g
- Tolerance range of closing force
- Blade length
- Maximum opening
- Blade geometry
- Serial number
- Jaw profile
- Material description
- Lot number
- the notes "NOT STERILE"
- WARNING

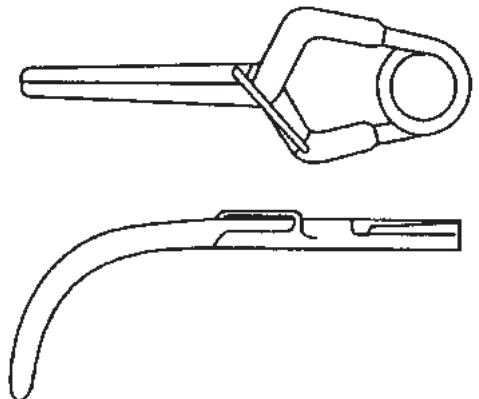

YASARGIL – Aneurysmen – Gefäß – Clips

YASARGIL – Aneurysm – Vessel – Clips

YASARGIL – Clips para aneurisma

YASARGIL – Clips per aneurisma

aus hochwertigem Implantat-Stahl antimagnetisch  
 in high quality Implant steel antimagnetic  
 de acero inoxidable para implantes de alta calidad, antimagnético  
 Prodotto in acciaio di alta qualità, antimagnetico

## Features of the Clip

### JAW-PROFILE

The rounded, pyramid-like structure is stamped into the jaw through a special step in production and prevents sharp edged which could perforate an aneurysm

No edges or burrs through additional rounding of structures that border the clip outer side because of this, real atraumatic application of the clip

Increased surface area due to the pyramid-like design of the jaws inner surface the cross-like structure of the inner jaws pyramid surface doubles the tissue-holding area.

The applied pressure distributes itself evenly over the length of the jaw.

The convex closure of the clip assures an atraumatic and secure closure of the aneurysm.

Sliding of the clip is prevented.

### SPRING-DESIGN

The spring size, wich is different in the Standard and Mini clips, ist the same within the same type of the Clip.

Through this, the highest degree of a secure fit is ensured by the clip applicator (clip/clip applicator fit)

### LINK-DESIGN

Laser welded

The link ensures the precise guidance of the jaws and a "soft" opening of the clip during the whole spreading process.

The contact surface of the jaws are guided symmetrically in an exact way "over the whole lenght" this fact guarantees an additional stability of the clip.

No over-stress of the material because the design of the link limits the maximum opening width.

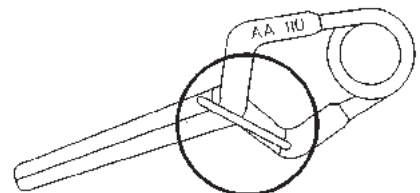
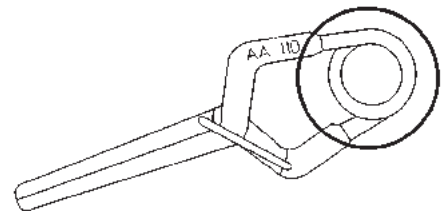
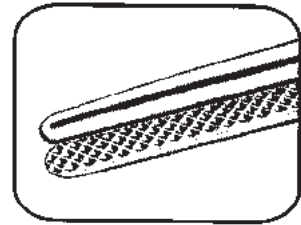
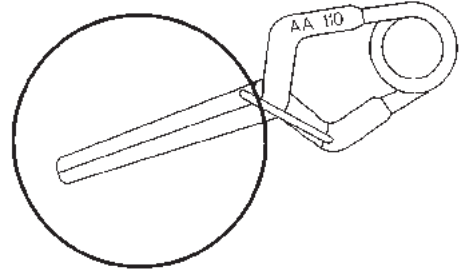



YASARGIL – Aneurysmen – Gefäß – Clips

YASARGIL – Aneurysm – Vessel – Clips

YASARGIL – Clips para aneurisma

YASARGIL – Clips per aneurisma

aus hochwertigem Implantat-Stahl antimagnetisch  
in high quality Implant steel antimagnetic  
de acero inoxidable para implantes de alta calidad, antimagnético  
Prodotto in acciaio di alta qualità, antimagnetico

Erklärung zum Katalog-System

Instructions for the catalogue-system

Explicaciones para el sistema del catálogo

Esempio del sistema del catalogo

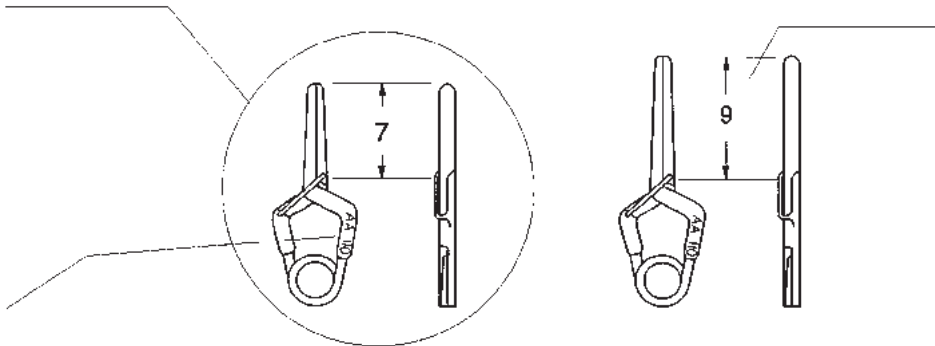

YASARGIL – Aneurysmen – Gefäß – Clips  
 YASARGIL – Aneurysm – Vessel – Clips  
 YASARGIL – Clips para aneurisma  
 YASARGIL – Clips per aneurisma

aus hochwertigem Implantat-Stahl antimagnetisch  
 in high quality Implant steel antimagnetic  
 de acero inoxidable para implantes de alta calidad, antimagnético  
 Prodotto in acciaio di alta qualità, antimagnetico

YASARGIL-STANDARD für permanenten Verschluss  
 YASARGIL-STANDARD for permanent closure  
 YASARGIL-STANDARD para cierre permanente  
 YASARGIL-STANDARD con chiusura permanente

## Standard

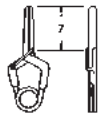
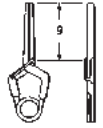
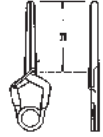
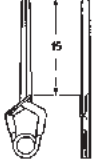
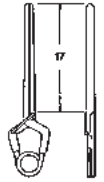
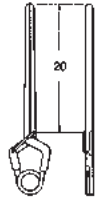
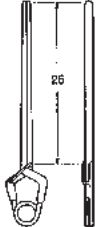
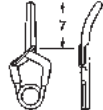
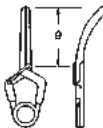
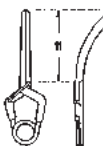
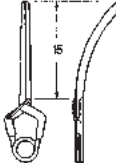
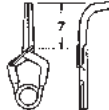
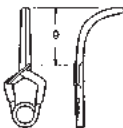
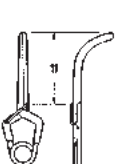
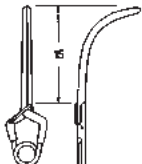
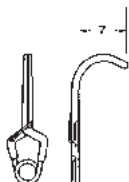
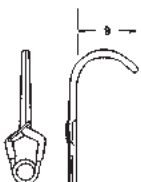
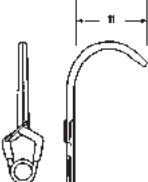
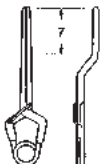
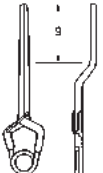

							
Cat. Nr.	41600-62	41600-70	41600-78	41600-92	41601-10	41601-11	
	<b>41600-62 T</b>	<b>41600-70 T</b>	<b>41600-78 T</b>	<b>41600-92 T</b>	<b>41601-10 T</b>	<b>41601-11 T</b>	
max. opening	6,2 mm	7,0 mm	7,8 mm	9,2 mm	10,6 mm	11,4 mm	
Force	150 gms	180 gms	180 gms	200 gms	200 gms	200 gms	
							
	41601-13	41602-60	41602-68	41602-75	41602-87	41603-55	41603-61
	<b>41601-13 T</b>	<b>41602-60 T</b>	<b>41602-68 T</b>	<b>41602-75 T</b>	<b>41602-87 T</b>	<b>41603-55 T</b>	<b>41603-61 T</b>
	13,3 mm	6,0 mm	6,8 mm	7,5 mm	8,7 mm	5,5 mm	6,1 mm
	200 gms	150 gms	180 gms	180 gms	200 gms	150 gms	180 gms
							
	41603-65	41603-74	41604-54	41604-58	41604-62	41604-79	41604-87
	<b>41603-65 T</b>	<b>41603-74 T</b>	<b>41604-54 T</b>	<b>41604-58 T</b>	<b>41604-62 T</b>	<b>41604-79 T</b>	<b>41604-87 T</b>
	6,5 mm	7,4 mm	5,4 mm	5,8 mm	6,2 mm	7,9 mm	8,7 mm
	180 gms	200 gms	180 gms	180 gms	180 gms	200 gms	200 gms

YASARGIL – Aneurysmen – Gefäß – Clips  
 YASARGIL – Aneurysm – Vessel – Clips  
 YASARGIL – Clips para aneurisma  
 YASARGIL – Clips per aneurisma

aus hochwertigem Implantat-Stahl antimagnetisch  
 in high quality Implant steel antimagnetic  
 de acero inoxidable para implantes de alta calidad, antimagnético  
 Prodotto in acciaio di alta qualità, antimagnetico

YASARGIL-STANDARD für permanenten Verschluss  
 YASARGIL-STANDARD for permanent closure  
 YASARGIL-STANDARD para cierre permanente  
 YASARGIL-STANDARD con chiusura permanente

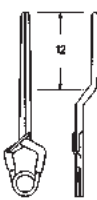
## Standard

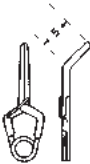
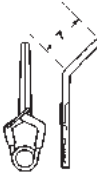
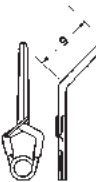
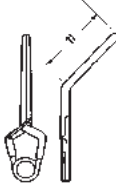
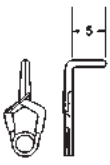
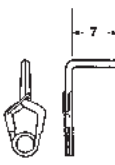
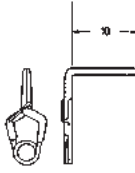
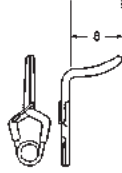
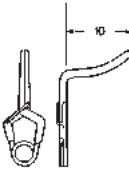
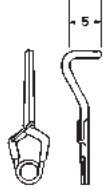
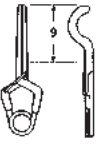
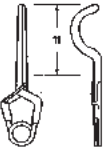
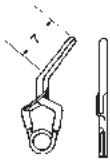
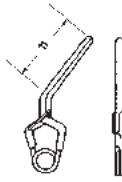
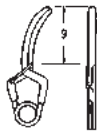
							
Cat. Nr.	41605-10	41605-12	41605-13	41606-62	41606-65	41606-78	
	<b>41605-10 T</b>	<b>41605-12 T</b>	<b>41605-13 T</b>	<b>41606-62-T</b>	<b>41606-65 T</b>	<b>41606-78 T</b>	
max. opening	10,2 mm	11,9 mm	13,0 mm	6,2 mm	6,5 mm	7,8 mm	
Force	200 gms	180 gms	180 gms	200 gms	200 gms	200 gms	
							
	41606-84	41607-56	41607-57	41607-58	41607-59	41607-60	41607-72
	<b>41606-84 T</b>	<b>41607-56 T</b>	<b>41607-57 T</b>	<b>41607-58 T</b>	<b>41607-59 T</b>	<b>41607-60 T</b>	<b>41607-72 T</b>
	8,4 mm	5,6 mm	5,6 mm	5,6 mm	5,4 mm	5,6 mm	7,2 mm
	200 gms	200 gms	200 gms	200 gms	200 gms	200 gms	200 gms
							
	41607-73	41607-82	41608-57	41608-80	41609-70		
	<b>41607-73 T</b>	<b>41607-82 T</b>	<b>41608-57 T</b>	<b>41608-80 T</b>	<b>41609-70 T</b>		
	7,2 mm	8,2 mm	5,7 mm	8,0 mm	7,0 mm		
	200 gms	200 gms	200 gms	200 gms	200 gms		

YASARGIL – Aneurysmen – Gefäß – Clips  
 YASARGIL – Aneurysm – Vessel – Clips  
 YASARGIL – Clips para aneurisma  
 YASARGIL – Clips per aneurisma

aus hochwertigem Implantat-Stahl antimagnetisch  
 in high quality Implant steel antimagnetic  
 de acero inoxidable para implantes de alta calidad, antimagnético  
 Prodotto in acciaio di alta qualità, antimagnetico

YASARGIL-STANDARD für temporären Verschluss  
 YASARGIL-STANDARD for temporary closure  
 YASARGIL-STANDARD para cierre temporal  
 YASARGIL-STANDARD con chiusura temporanea

## Standard

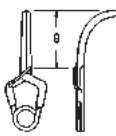
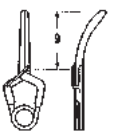
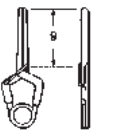
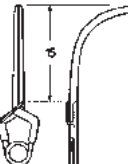
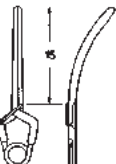
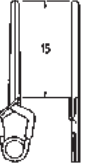
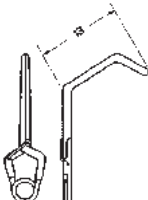
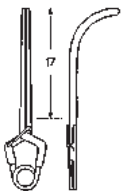
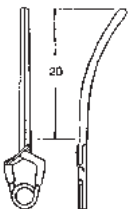
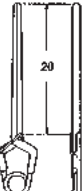
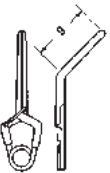
						
Cat. Nr.	41610-61	41610-68	41610-70	41611-74	41611-87	41611-92
	<b>41610-61 T</b>	<b>41610-68 T</b>	<b>41610-70 T</b>	<b>41611-74 T</b>	<b>41611-87 T</b>	<b>41611-92 T</b>
max. opening	6,1 mm	6,8 mm	7,0 mm	7,4 mm	8,7 mm	9,2 mm
Force	70 gms	70 gms	70 gms	70 gms	70 gms	70 gms
						
	41612-07	41612-09	41612-11	41612-12	41612-62	
	<b>41612-07 T</b>	<b>41612-09 T</b>	<b>41612-11 T</b>	<b>41612-12 T</b>	<b>41612-62 T</b>	
	7,5 mm	9,9 mm	11,0 mm	11,4 mm	6,2 mm	
	90 gms	90 gms	90 gms	90 gms	70 gms	

YASARGIL – Aneurysmen – Gefäß – Clips  
 YASARGIL – Aneurysm – Vessel – Clips  
 YASARGIL – Clips para aneurisma  
 YASARGIL – Clips per aneurisma

aus hochwertigem Implantat-Stahl antimagnetisch  
 in high quality Implant steel antimagnetic  
 de acero inoxidable para implantes de alta calidad, antimagnético  
 Prodotto in acciaio di alta qualità, antimagnetico

YASARGIL-STANDARD für permanenten Verschluss  
 YASARGIL-STANDARD for permanent closure  
 YASARGIL-STANDARD para cierre permanente  
 YASARGIL-STANDARD con chiusura permanente

## Standard

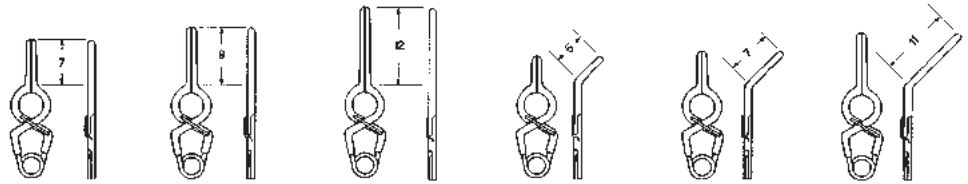

Cat. Nr.	41613-74 <b>41613-74 T</b>	41613-84 <b>41613-84 T</b>	41613-96 <b>41613-96 T</b>	41614-58 <b>41614-58 T</b>	41614-65 <b>41614-65 T</b>	41614-72 <b>41614-72 T</b>
max. opening	7,4 mm	8,4 mm	9,6 mm	5,8 mm	6,5 mm	7,2 mm
Force	150 gms	150 gms	180 gms	150 gms	150 gms	180 gms

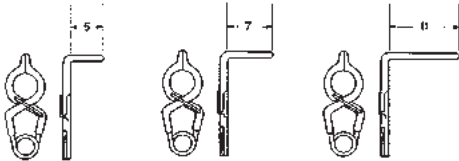

41615-49 <b>41615-49 T</b>	41615-50 <b>41615-50 T</b>	41615-51 <b>41615-51 T</b>
4,9 mm	4,9 mm	4,9 mm
150 gms	150 gms	180 gms

YASARGIL – Aneurysmen – Gefäß – Clips  
 YASARGIL – Aneurysm – Vessel – Clips  
 YASARGIL – Clips para aneurisma  
 YASARGIL – Clips per aneurisma

aus hochwertigem Implantat-Stahl antimagnetisch  
 in high quality Implant steel antimagnetic  
 de acero inoxidable para implantes de alta calidad, antimagnético  
 Prodotto in acciaio di alta qualità, antimagnetico

YASARGIL-STANDARD für permanenten Verschluss  
 YASARGIL-STANDARD for permanent closure  
 YASARGIL-STANDARD para cierre permanente  
 YASARGIL-STANDARD con chiusura permanente

## Standard

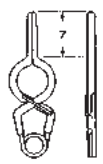
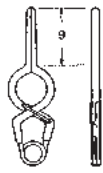
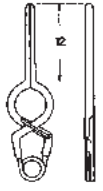
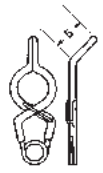
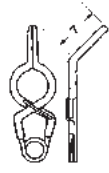
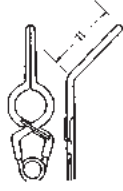
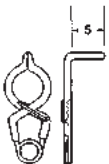
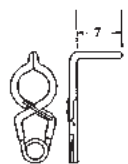
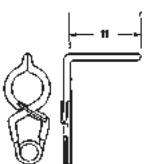
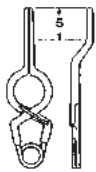
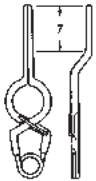
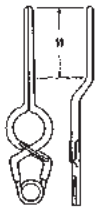





						
Cat. Nr.	41616-79	41616-91	41617-10	41617-65	41617-72	41617-78
	<b>41616-79 T</b>	<b>41616-91 T</b>	<b>41617-10 T</b>	<b>41617-65 T</b>	<b>41617-72 T</b>	<b>41617-78 T</b>
max. opening	7,9 mm	9,1 mm	10,3 mm	6,5 mm	7,2 mm	7,8 mm
Force	150 gms	150 gms	180 gms	150 gms	150 gms	180 gms
						
	41618-55	41618-56	41618-57	41618-79	41618-88	41619-00
	<b>41618-55 T</b>	<b>41618-56 T</b>	<b>41618-57 T</b>	<b>41618-79 T</b>	<b>41618-88 T</b>	<b>41619-00 T</b>
	5,5 mm	5,5 mm	5,5 mm	7,9 mm	8,8 mm	10,0 mm
	150 gms	150 gms	180 gms	150 gms	150 gms	180 gms

YASARGIL – Aneurysmen – Gefäß – Clips  
 YASARGIL – Aneurysm – Vessel – Clips  
 YASARGIL – Clips para aneurisma  
 YASARGIL – Clips per aneurisma

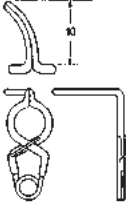
aus hochwertigem Implantat-Stahl antimagnetisch  
 in high quality Implant steel antimagnetic  
 de acero inoxidable para implantes de alta calidad, antimagnético  
 Prodotto in acciaio di alta qualità, antimagnetico

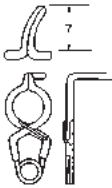
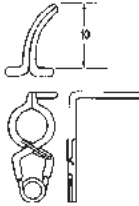
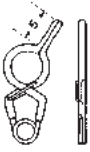
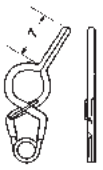
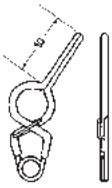
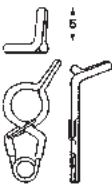
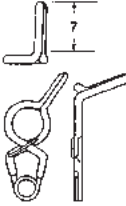
YASARGIL-STANDARD für permanenten Verschluss  
 YASARGIL-STANDARD for permanent closure  
 YASARGIL-STANDARD para cierre permanente  
 YASARGIL-STANDARD con chiusura permanente

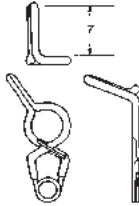
## Standard

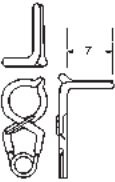
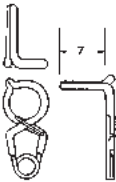
							
Cat. Nr.	41620-58	41620-59	41620-60	41620-61	41620-62	41620-63	
	<b>41620-58 T</b>	<b>41620-59 T</b>	<b>41620-60 T</b>	<b>41620-61 T</b>	<b>41620-62 T</b>	<b>41620-63 T</b>	
max. opening	5,8 mm	5,8 mm	5,8 mm	5,8 mm	5,8 mm	5,8 mm	
Force	150 gms	150 gms	150 gms	150 gms	150 gms	150 gms	
							
	41620-70	41620-78	41620-88	41621-58	41621-62	41622-58	41622-62
	<b>41620-70 T</b>	<b>41620-78 T</b>	<b>41620-88 T</b>	<b>41621-58 T</b>	<b>41621-62 T</b>	<b>41622-58 T</b>	<b>41622-62 T</b>
	7,0 mm	7,8 mm	8,8 mm	5,8 mm	6,2 mm	5,8 mm	6,2 mm
	150 gms	150 gms	150 gms	150 gms	150 gms	150 gms	150 gms
							
	41623-56	41624-56	41625-56	41626-56			
	<b>41623-56 T</b>	<b>41624-56 T</b>	<b>41625-56 T</b>	<b>41626-56 T</b>			
	5,6 mm	5,6 mm	5,6 mm	5,6 mm			
	150 gms	150 gms	150 gms	150 gms			

YASARGIL – Aneurysmen – Gefäß – Clips

YASARGIL – Aneurysm – Vessel – Clips

YASARGIL – Clips para aneurisma

YASARGIL – Clips per aneurisma

aus hochwertigem Implantat-Stahl antimagnetisch  
 in high quality Implant steel antimagnetic  
 de acero inoxidable para implantes de alta calidad, antimagnético  
 Prodotto in acciaio di alta qualità, antimagnetico













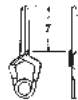

YASARGIL-STANDARD für permanenten Verschluss

YASARGIL-STANDARD for permanent closure

YASARGIL-STANDARD para cierre permanente

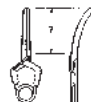
YASARGIL-STANDARD con chiusura permanente

## Mini

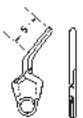
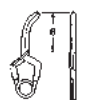
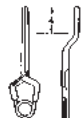
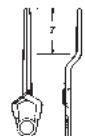
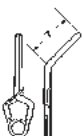
							
Cat. Nr.	41627-33	41627-40	41628-33	41628-40	41628-46	41629-32	
	<b>41627-33 T</b>	<b>41627-40 T</b>	<b>41628-33 T</b>	<b>41628-40 T</b>	<b>41628-46 T</b>	<b>41629-32 T</b>	
max. opening	3,3 mm	4,0 mm	3,3 mm	4,0 mm	4,6 mm	3,2 mm	
Force	110 gms	110 gms	110 gms	110 gms	110 gms	110 gms	
							
	41629-38	41630-36	41630-38	41631-36	41631-40	41631-44	41632-36
	<b>41629-38 T</b>	<b>41630-36 T</b>	<b>41630-38 T</b>	<b>41631-36 T</b>	<b>41631-40 T</b>	<b>41631-44 T</b>	<b>41632-36 T</b>
	3,8 mm	3,6 mm	3,8 mm	3,6 mm	4,0 mm	4,4 mm	3,6 mm
	110 gms	110 gms	110 gms	110 gms	110 gms	110 gms	110 gms
							
	41633-35	41633-40	41634-35	41634-60	41634-70	41635-57	41636-45
	<b>41633-35 T</b>	<b>41633-40 T</b>	<b>41634-35 T</b>	<b>41634-60 T</b>	<b>41634-70 T</b>	<b>41635-57 T</b>	<b>41636-45 T</b>
	3,5 mm	4,0 mm	3,5 mm	6,0 mm	7,0 mm	5,7 mm	4,5 mm
	110 gms	110 gms	130 gms	130 gms	130 gms	130 gms	130 gms



YASARGIL – Aneurysmen – Gefäß – Clips  
 YASARGIL – Aneurysm – Vessel – Clips  
 YASARGIL – Clips para aneurisma  
 YASARGIL – Clips per aneurisma

aus hochwertigem Implantat-Stahl antimagnetisch  
 in high quality Implant steel antimagnetic  
 de acero inoxidable para implantes de alta calidad, antimagnético  
 Prodotto in acciaio di alta qualità, antimagnetico

YASARGIL-STANDARD für temporären Verschluss  
 YASARGIL-STANDARD for temporary closure  
 YASARGIL-STANDARD para cierre temporal  
 YASARGIL-STANDARD con chiusura temporanea

## Mini

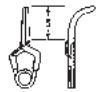
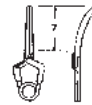

Cat. Nr.	41637-33 <b>41637-33 T</b>	41637-40 <b>41637-40 T</b>	41638-38 <b>41638-38 T</b>	41638-46 <b>41638-46 T</b>	41639-44 <b>41639-44 T</b>	41640-40 <b>41640-40 T</b>
max. opening	3,3 mm	4,0 mm	3,8 mm	4,6 mm	4,4 mm	4,0 mm
Force	50 gms	50 gms	50 gms	70 gms	70 gms	70 gms

Anlegezange mit Rundgriff – FLEXIBEL – mit und ohne drehbarem Maulteil  
 Applying forceps with round shaft – FLEXIBLE – with and without Rotation  
 Pinzas de aplicación con mango redondo – FLEXIBLE – con y sin rotación  
 Posa clips con manico rotonda guaina FLESSIBILE cover sistema rotante ed non rotante

Länge		
Length		
Largo		
Lunghezza	MINI	STANDARD
70 mm	41641-07	41643-07
90 mm	41641-09	41643-09
110 mm	41641-11	41643-11

nicht drehbar  
 non rotating  
 sin rotación  
 non rotante



Länge		
Length		
Largo		
Lunghezza	MINI	STANDARD
70 mm	41642-07	41644-07
90 mm	41642-09	41644-09
110 mm	41642-11	41644-11

drehbar  
 rotating  
 rotante  
 rotante

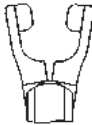

drehbar  
 rotating  
 rotante  
 rotante

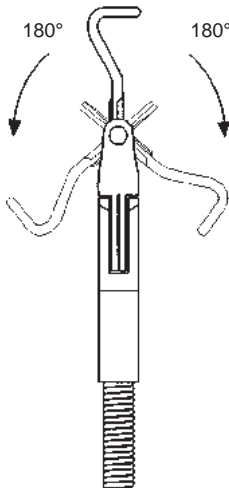

Beispiel für Drehmechanismus  
 Example for Rotation  
 Ejemplo de la rotación  
 Esempio della rotazione

Clips drehbar im Maul  
 Clips rotabile in jaw  
 Clips rotabile en la boca  
 Clips rotabile nel morso

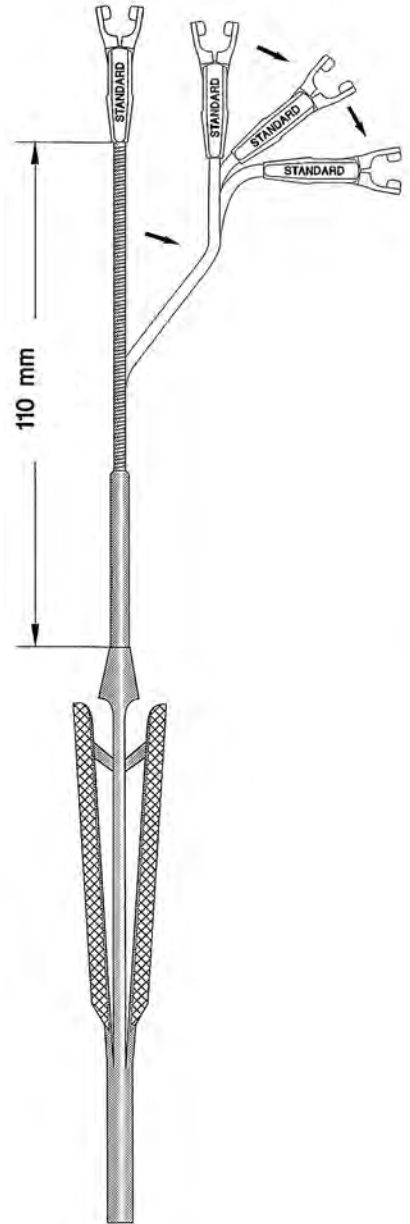

41641-07 - 41644-11

Anlegezange mit Rundgriff – starr – mit und ohne drehbarem Maulteil  
 Applying forceps with round shaft – rigid – with and without Rotation  
 Pinzas de aplicación con mango redondo – rigido – con y sin rotación  
 Posa clips con manico rotonda guaina rigida cover sistema rotante ed non rotante

Länge		
Length		
Largo		
Lunghezza	MINI	STANDARD
70 mm	41645-07	41647-07
90 mm	41645-09	41647-09
110 mm	41645-11	41647-11

nicht drehbar  
 non rotating  
 sin rotación  
 non rotante

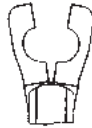

Länge		
Length		
Largo		
Lunghezza	MINI	STANDARD
70 mm	41646-07	41648-07
90 mm	41646-09	41648-09
110 mm	41646-11	41648-11

drehbar  
 rotating  
 rotante  
 rotante



drehbar  
 rotating  
 rotante  
 rotante

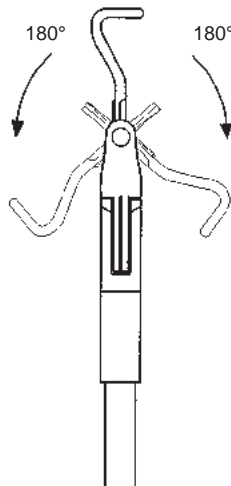

Beispiel für Drehmechanismus  
 Example for Rotation  
 Ejemplo de la rotación  
 Esempio della rotazione

Clips drehbar im Maul  
 Clips rotabile in jaw  
 Clips rotabile en la boca  
 Clips rotabile nel morso

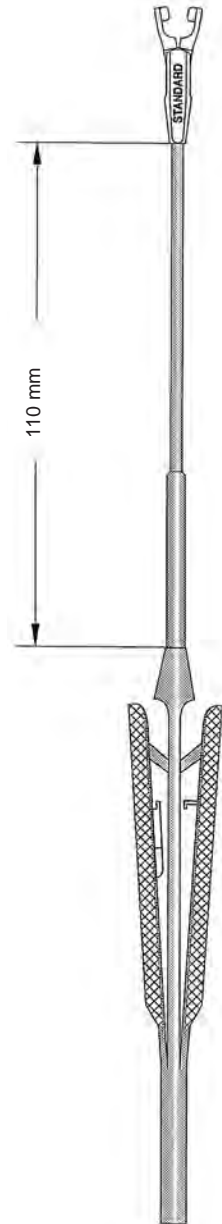

41645-07 - 41648-11

Anlegezange mit Rundgriff – starr – mit und ohne drehbarem Maulteil  
 Applying forceps with round shaft – rigid – with and without Rotation  
 Pinzas de aplicación con manico redondo – rigido – con y sin rotación  
 Posa clips con manico rotonda gaina rigida cover sistema rotante ed non rotante

Länge		
Length		
Largo		
Lunghezza	MINI	STANDARD
70 mm	41649-07	41651-07
90 mm	41649-09	41651-09
110 mm	41649-11	41651-11

nicht drehbar  
 non rotating  
 sin rotación  
 non rotante

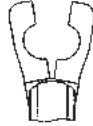

Länge		
Length		
Largo		
Lunghezza	MINI	STANDARD
70 mm	41650-07	41652-07
90 mm	41650-09	41652-09
110 mm	41650-11	41652-11

drehbar  
 rotating  
 rotante  
 rotante

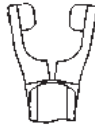

drehbar  
 rotating  
 rotante  
 rotante

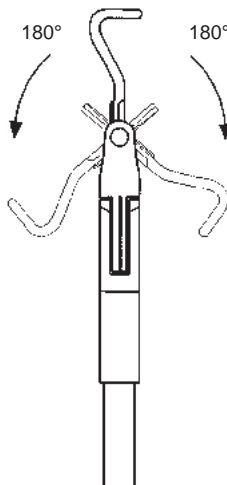

Beispiel für Drehmechanismus  
 Example for Rotation  
 Ejemplo de la rotación  
 Esempio della rotazione

Clips drehbar im Maul  
 Clips rotabile in jaw  
 Clips rotabile en la boca  
 Clips rotabile nel morso

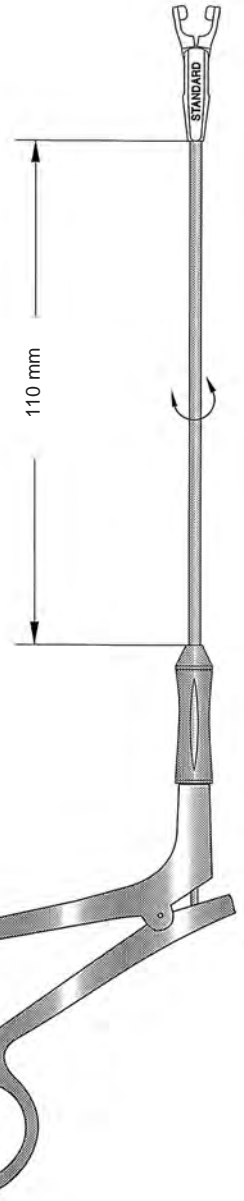

41649-07 - 41652-11

Anlegezange – mit und ohne drehbarem Maulteil  
 Applying Forceps – with and without Rotation  
 Pinzas de aplicación, con y sin rotación  
 Pinza posa clips, con ed senza rotazione

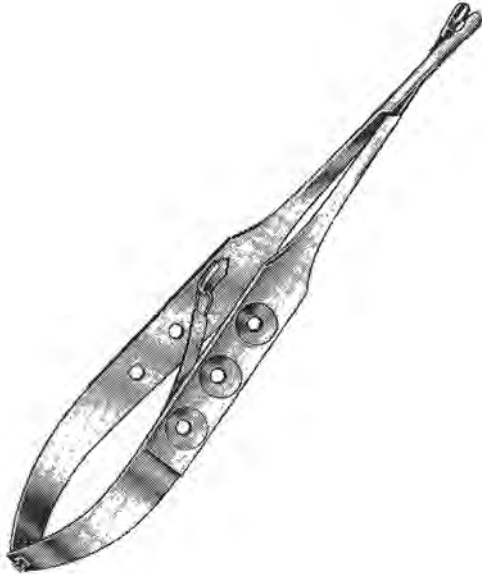

MINI	41653-18	
STANDARD	41654-18	
MINI	41655-18	drehbar / rotating rotante / rotante
STANDARD	41656-18	drehbar / rotating rotante / rotante

Anlegezange gerade, mit Sperre, Länge 18 cm, 7"  
 Applying Forceps straight, with Ratchet, Length 18 cm, 7"  
 Pinza de aplicación, con cremallera, 18 cm, 7"  
 Posa clips, retta con bloccaggio lunghezza 18 cm, 7"





Länge			
Length			
Largo			
Lunghezza	17 cm, 6 3/4"	21 cm, 8 1/4"	23 cm, 9"
MINI	41657-17	41657-21	41657-23
STANDARD	41658-17	41658-21	41658-23
MINI	41659-17	41659-21	41659-23
	drehbar / rotating / rotante / rotante		
STANDARD	41660-17	41660-21	41660-23
	drehbar / rotating / rotante / rotante		

Clips drehbar im Maul  
 Clips rotatable in jaw  
 Clips rotatable en la boca  
 Clips rotabile nel morso

Anlegezange bayonett, mit Sperre  
 Applying Forceps bajonett, with Ratchet  
 Pinza de aplicación bayoneta, con cremallera  
 Posa clips a baionetta con bloccaggio

Gefäßclips nach BIEMER  
 BIEMER Vessel Clips  
 Clips para vasos de BIEMER  
 Clips per vasi secondo BIEMER

	Maulöffnung Opening	Maullänge Length of jaws	Schließkraft Closing Force
 41661-40	Apertura de la boca Apertura del morso 4,0 mm	Largo de la boca Lunghezza del morso 6,0 mm	Fuerza del cierre Forza di chiusura 30 - 40 g (0,29 - 0,39 N)
 41661-50	5,0 mm	9,0 mm	30 - 40 g (0,29 - 0,39 N)
 41662-50	5,0 mm	9,0 mm	20 - 25 g (0,20 - 0,25 N)

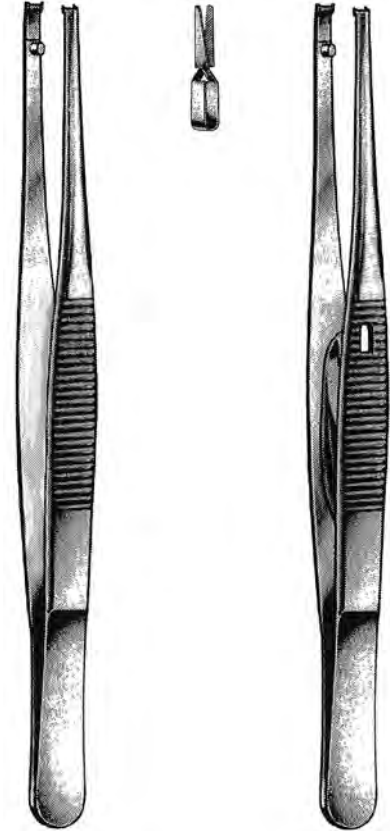

### für temporären Gebrauch

gekennzeichnet durch gelb eingefärbte Federenden  
 für Gefäße mit einem Durchmesser 0,5 - 2,0 mm

Maulinnenflächen schräg gerieft für schonendes,  
 sicheres Festhalten der Gefäße

Der fest eingestellte Schließdruck gewährt risikofreie  
 Anwendung

### for temporary occlusion

(identified by yellow coloured spring ends) for vessel  
 diam. 0,5 - 2,0 mm

Blade gripping surface with oblique serrations for  
 save but careful gripping of vessels

No risk due to rigidly fixed pressure measure

### para uso temporal

clips marcados con baño dorado en los resortes,  
 para vasos con un diámetro de 0,5 - 2,0 mm

El interior de las quijadas viene con estrias finas para  
 un agarre seguro y cuidadoso de los vasos

Debido a la calibración exacta de la fuerza de cierre  
 se ofrece una aplicación sin riesgo

### per chiusura temporanea

per vasi con Diametro 0,5 - 2,0 mm

La chiusura regolata garantisce nessun rischio

BIEMER  
 41663-01

Anlegepinzette ohne Schloß,  
 für Mikro-Gefäßclips  
 41661-40 - 41662-50  
 und  
 Approximatoren  
 41667-30 - 41670-50  
 und  
 41672-01 - 41672-04

Applying forceps without lock.  
 for vessel clips  
 41661-40 - 41662-50  
 and  
 Aproximators  
 41667-30 - 41670-50  
 and  
 41672-01 - 41672-04

BIEMER  
 41663-02

Anlegepinzette mit Schloß,  
 für Mikro-Gefäßclips  
 41661-40 - 41662-50  
 und  
 Approximatoren  
 41667-30 - 41670-50  
 und  
 41672-01 - 41672-04

Applying forceps with lock.  
 for vessel clips  
 41661-40 - 41662-50  
 and  
 Aproximators  
 41667-30 - 41670-50  
 and  
 41672-01 - 41672-04

Gefäßclips nach MEHDORN  
 MEHDORN Vessel Clips  
 Clips para vasos de MEHDORN  
 Clips secondo MEHDORN

für temporären Gebrauch

gekennzeichnet durch gelb eingefärbte Federenden für Gefäße mit einem Durchmesser 0,5 - 1,5 mm

Maulinnenflächen schräg gerieft für schonendes, sicheres Festhalten der Gefäße

Der fest eingestellte Schließdruck gewährt risikofreie Anwendung

for temporary occlusion

(identified by yellow coloured spring ends) for vessel diam. 0,5 - 1,5 mm

Blade gripping surface with oblique serrations for safe but careful gripping of vessels

No risk due to rigidly fixed pressure measure

para uso temporal

clips marcados con baño dorado en los resortes, para vasos con un diámetro de 0.5 - 1.5 mm

El interior de las quijadas viene con estrias finas para un agarre seguro y cuidadoso de los vasos

Debido a la calibración exacta de la fuerza de cierre se ofrece una aplicación sin riesgo

per chiusura temporanea

per vasi con Diametro 0,5 - 1,5 mm

La chiusura regolata garantisce nessun rischio





Beispiele für die variable Position des Clips

Ejemplo para la variedad de la aplicación del clip

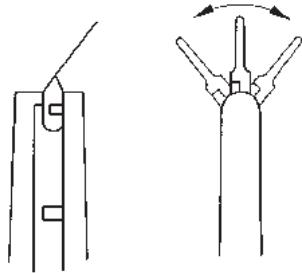
Esempio: posizioni variabili delle clips

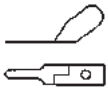
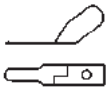
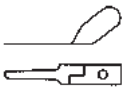

	Maullänge Length of jaws Largo de la boca Lunghezza del morso	Schließkraft Closing Force Fuerza del cierre Forza di chiusura	MEHDORN 41666-00
	41664-10 4 x 1,0 mm	10 - 15 g (0,10 - 0,15 N)	Anlegepinzette für Mikro-Gefäßclips 41664-10 - 41665-14
	41664-14 4 x 1,4 mm	15 - 20 g (0,15 - 0,20 N)	Applying Forceps for vessel clips 41664-10 - 41665-14
	41665-10 6 x 1,0 mm	10 - 15 g (0,10 - 0,15 N)	Pinza de aplicación para micro-clips 41664-10 - 41665-14
	41665-14 6 x 1,4 mm	15 - 20 g (0,15 - 0,20 N)	Pinza posa clips per microvasi 41664-10 - 41665-14

Approximatoren nach Biemer-Müller  
 Approximators Biemer-Müller  
 Aproximadores de Biemer-Müller  
 Aproximatore secondo Biemer-Müller

**für temporären Gebrauch**

gekennzeichnet durch gelb eingefärbte Federenden für Gefäße mit einem Durchmesser 0,5 - 2,0 mm  
 Maulinnenflächen schräg gerieft für schonendes, sicheres Festhalten der Gefäße  
 Der fest eingestellte Schließdruck gewährt risikofreie Anwendung

**for temporary occlusion**

(identified by yellow coloured spring ends) for vessel diam. 0,5 - 2,0 mm  
 Blade gripping surface with oblique serrations for save but careful gripping of vessels  
 No risk due to rigidly fixed pressure measure





**para uso temporal**

clips marcados con baño dorado en los resortes, para vasos con un diámetro de 0,5 - 2,0 mm  
 El interior de las quijadas viene con estrias finas para un agarre seguro y cuidadoso de los vasos  
 Debido a la calibración exacta de la fuerza de cierre se ofrece una aplicación sin riesgo

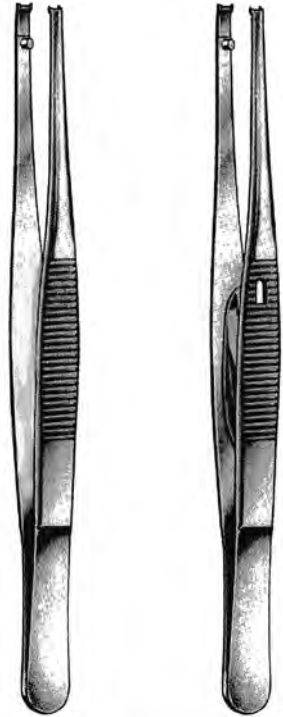
**per chiusura temporanea**

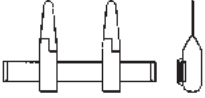
per vasi con Diametro 0,5 - 2,0 mm  
 La chiusura regolata garantisce nessun rischio

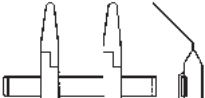

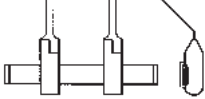
	Maulöffnung Opening	Maullänge Length of jaws	Schließkraft Closing Force
	Apertura de la boca Apertura del morso	Largo de la boca Lunghezza del morso	Fuerza del cierre Forza di chiusura
	3,0 mm	4,5 mm	30 - 40 g (0,29 - 0,39 N)
	5,0 mm	9,0 mm	30 - 40 g (0,29 - 0,39 N)
	5,0 mm	9,0 mm	30 - 40 g (0,20 - 0,25 N)
	5,0 mm	9,0 mm	30 - 40 g (0,20 - 0,25 N)
	5,0 mm	9,0 mm	30 - 40 g (0,20 - 0,25 N)

BIEMER  
41663-01

BIEMER  
41663-02

Anlegepinzette ohne  
Schloß,  
für Mikro-Gefäßclips  
41661-40 - 41662-50  
und  
Approximatoren  
41667-30 - 41670-50  
und  
41672-01 - 41672-04

Anlegepinzette mit  
Schloß,  
für Mikro-Gefäßclips  
41661-40 - 41662-50  
und  
Approximatoren  
41667-30 - 41670-50  
und  
41672-01 - 41672-04

Applying forceps without  
lock.  
for vessel clips  
41661-40 - 41662-50  
and  
Aproximators  
41667-30 - 41670-50  
and  
41672-01 - 41672-04

Applying forceps with  
lock.  
for vessel clips  
41661-40 - 41662-50  
and  
Aproximators  
41667-30 - 41670-50  
and  
41672-01 - 41672-04



Approximatoren nach Müller  
 Müller Approximators  
 Aproximadores de Müller  
 Apressimatore secondo Müller

**für temporären Gebrauch**

gekennzeichnet durch gelb eingefärbte Federenden für Gefäße mit einem Durchmesser 0,5 - 2,0 mm  
 Maulinnenflächen schräg gerieft für schonendes, sicheres Festhalten der Gefäße  
 Der fest eingestellte Schließdruck gewährt risikofreie Anwendung

**for temporary occlusion**

(identified by yellow coloured spring ends) for vessel diam. 0,5 - 2,0 mm  
 Blade gripping surface with oblique serrations for save but careful gripping of vessels  
 No risk due to rigidly fixed pressure measure





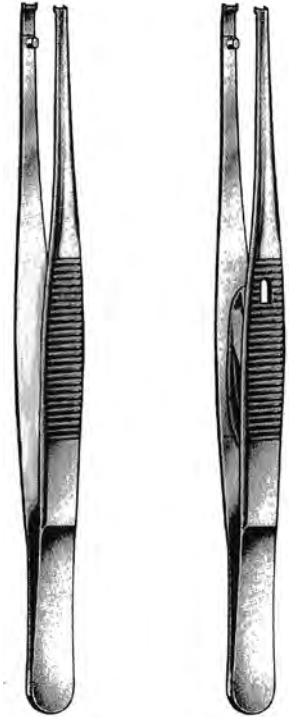

**para uso temporal**

clips marcados con baño dorado en los resortes, para vasos con un diámetro de 0,5 - 2,0 mm  
 El interior de las quijadas viene con estrias finas para un agarre seguro y cuidadoso de los vasos  
 Debido a la calibración exacta de la fuerza de cierre se ofrece una aplicación sin riesgo

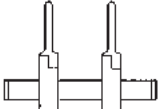
**per chiusura temporanea**

per vasi con Diametro 0,5 - 2,0 mm  
 La chiusura regolata garantisce nessun rischio



		Ø Diameter	Schließkraft Closing Force Fuerza del cierre Forza di chiusura
41672-01		1,0 mm	25 - 30 g (0,25 - 0,29 N)
41672-02		2,0 mm	25 - 30 g (0,25 - 0,29 N)
41672-03		3,0 mm	25 - 30 g (0,25 - 0,29 N)
41672-04		4,0 mm	25 - 30 g (0,25 - 0,29 N)

BIEMER  
41663-01

Anlegepinzette ohne  
Schloß,  
für Mikro-Gefäßclips  
41661-40 - 41662-50  
und  
Approximatoren  
41667-30 - 41670-50  
und  
41672-01 - 41672-04

Applying forceps without  
lock.  
for vessel clips  
41661-40 - 41662-50  
and  
Aproximadors  
41667-30 - 41670-50  
and  
41672-01 - 41672-04

BIEMER  
41663-02

Anlegepinzette mit  
Schloß,  
für Mikro-Gefäßclips  
41661-40 - 41662-50  
und  
Approximatoren  
41667-30 - 41670-50  
und  
41672-01 - 41672-04

Applying forceps with  
lock.  
for vessel clips  
41661-40 - 41662-50  
and  
Aproximadors  
41667-30 - 41670-50  
and  
41672-01 - 41672-04

Gefäßclips nach Müller  
 Müller Vessel Clips  
 Clips para vasos de Müller  
 Clip secondo Müller

für temporären Gebrauch

Maulinnenflächen pyramidenförmig für schonendes, sicheres Festhalten der Gefäße

Der fest eingestellte Schließdruck gewährt risikofreie Anwendung

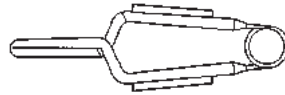

41674-50

Schließkraft  
 Closing Force  
 Fuerza del cierre  
 Forza di chiusura

50 g

for temporary occlusion

Blade gripping surface with pyramid-like impressions for save but careful gripping of vessels

No risk due to rigidly fixed pressure measure



41674-80

80 g

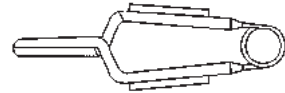

41675-50

50 g

para uso temporal

El interior de las quijadas viene en forma de pirámide para un agarre seguro y cuidadoso de los vasos.

Debido a la calibración exacta de la fuerza de cierre se ofrece una aplicación sin riesgo.

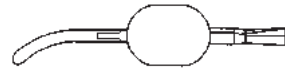

41675-80

80 g

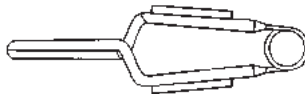

41676-50

50 g

per uso temporaneo

Morso interno con forma piramidale per garantire una chiusura sicura del vaso



41676-80

80 g



41677-50

50 g

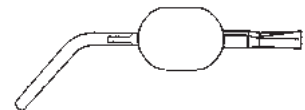

41677-80

80 g

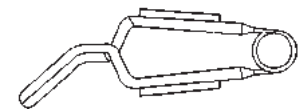

41678-50

50 g



41678-80

80 g

Approximator nach Biemer  
 Biemer Approximator  
 Aproximadores de Biemer  
 Approssimatore secondo Biemer

für Mikro-Gefäßanastomosen im oberflächlichen Bereich

Maulinnenflächen schräg gerieft für schonendes, sicheres Festhalten der Gefäße

Der fest eingestellte Schließdruck gewährt risikofreie Anwendung

Der Abstand zwischen den Clips ist durch einfaches Verschieben einzustellen und wird durch Verkanten fixiert

for micro vessel anastomosis in the superficial range

Blade gripping surface with oblique serrations for save but careful gripping of vessels

No risk due to rigidly fixed pressure measure

Adjustable distance between the clips and automatic fixation by tilting

para micro-anastomosis en la superficie

El interior de la quijada viene con estrias finas para un agarre seguro y cuidadoso de los vasos.

Debido a la calibración exacta de la fuerza de cierre se ofrece una aplicación sin riesgo.

El espacio entre los clips se logra fácilmente por el desplazamiento.

per micro vasi anastomosi sulla parte della superficie

Parte interna del morso è leggermente striata obliqua per ottenere la presa sulla superficie del vaso.

La chiusura regolata garantisce nessun rischio.

Lo scorrimento delle due clips viene regolato con semplice movimento che consente una chiusura ottimale.



BIEMER  
 41680-00

Anlegepinzette für Gefäß-  
 Approximator nach BIEMER

Applying forceps for BIEMER  
 vessel approximator

Pinza de aplicación para  
 aproximadores de BIEMER

Pinza posa clips per vasi  
 approssimatori secondo  
 BIEMER

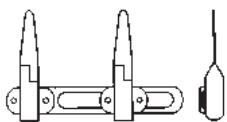

41679-25

Schließkraft  
 Closing Force  
 Fuerza de cierre  
 Forza di chiusura

25 - 30 g  
 (0,25 - 0,29 N)



LEYLA Retraktor System  
 LEYLA Retractor System  
 Separador de sistema LEYLA  
 LEYLA Sistema di fissaggio

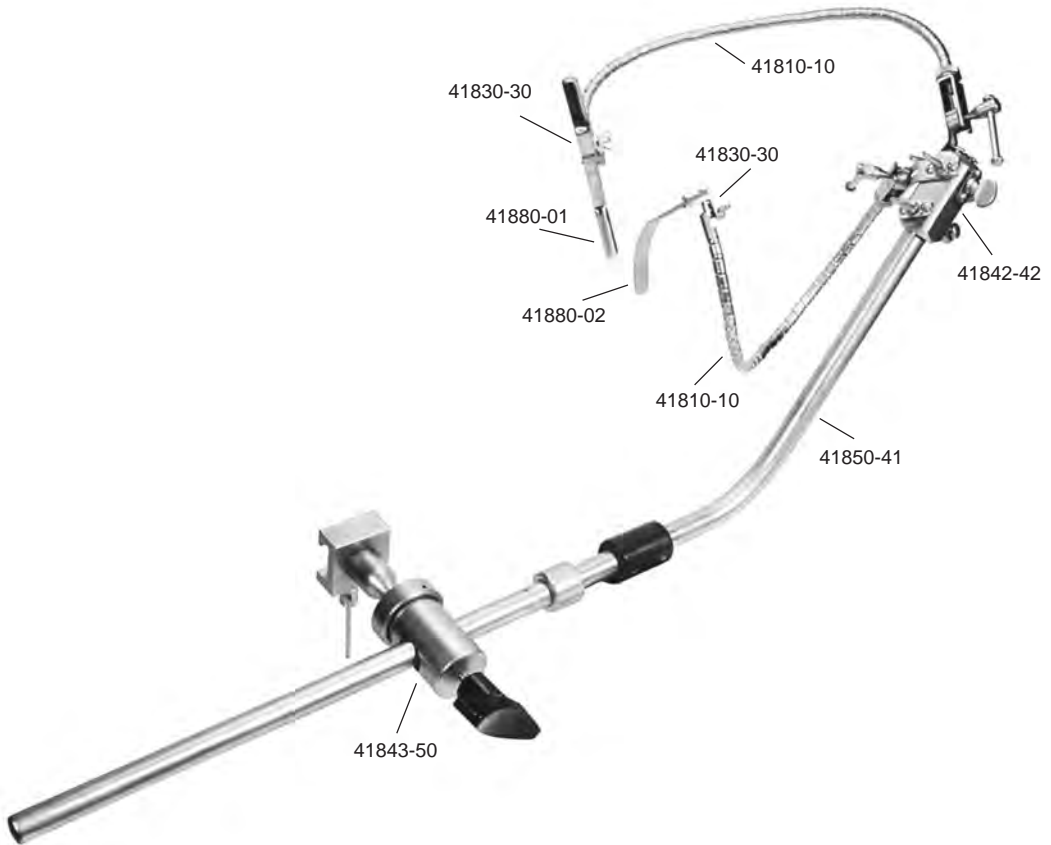

41802-00 LEYLA-Retraktor-System zum Fixieren am OP-Tisch komplett, bestehend aus:  
 LEYLA Self-Retraining Retractor for fixation to operating table, complete, consisting of:  
 Separador LEYLA para fijacion a la mesa de operaciones, completo, compuesto de:  
 LEYLA Sistema di fissaggio al tavolo operatorio, composto da:

- |          |  |          |   |
|----------|--|----------|---|
| 41843-50 | Kugelenkkloben (1x)<br>ball and socket joint (1x)<br>articulacion esferica (1x)<br>giunto per fissare (1x)           | 41830-30 | Spatelhalter für flache Spatel (2x)<br>support for flat brain spatula (2x)<br>soporte para espátulas cerebrales planas (2x)<br>sostegno per spatole piatte (2x) |
| 41850-41 | starrer Haltearm (1x)<br>rigid holding rod (1x)<br>brazo de fijación rigido (1x)<br>braccio di fissaggio rigido (1x) | 41880-01 | CUSHING Hirnspatel (1x)<br>CUSHING brain spatula (1x)<br>CUSHING espátula para cerebro (1x)<br>CUSHING spatola cerebrale (1x)                                   |
| 41842-42 | Kupplungskopf (1x)<br>coupling head (1x)<br>cabeza de acoplamiento (1x)<br>giunto per combinare (1x)                 | 41880-02 | CUSHING Hirnspatel (1x)<br>CUSHING brain spatula (1x)<br>CUSHING espátula para cerebro (1x)<br>CUSHING spatola cerebrale (1x)                                   |
| 41810-10 | flexibler Spannarm (2x)<br>flexible arm, only (2x)<br>brazo flexible, suelto (2x)<br>braccio flessibile, solo (2x)   |          |   |

LEYLA Retraktor System  
 LEYLA Retractor System  
 Separador de sistema LEYLA  
 LEYLA Sistema di fissaggio



- 41843-50** Kugelgelenkkloben  
 zum Befestigen an der OP-Tischschiene und zur Aufnahme  
 des Haltearms 41850-41  
 ball and socket joint  
 for fixation of holding rod 41850-41 at the operating table  
 articulation esferica, para sujetar el brazo de soporte rígido  
 sobre la mesa de operaciones 9 x 32 mm  
 giunto per fissare il braccio, articolato 9 x 32 mm



- 41850-41** starrer Haltearm, auseinandernehmbar, zur Fixation im  
 Kugelgelenkkloben 41843-50 und zur wahlweisen  
 Aufnahme der Kupplungsköpfe 41842-42, 41842-44  
 und 41842-46  
 holding rod, detachable, for fixation in ball and socket joint  
 41843-50 and to hold a desired coupling head  
 41842-42, 41842-44 or 41842-46  
 brazo de soporte rígido, desmontable, para fijación a la  
 articulación esferica 41843-50 y opcionalmente a las  
 cabezas 41842-42, 41842-44 y 41842-46  
 braccio di sostegno rígido, per fissaggio al giunto 41843-50  
 e dei giunti 41842-42, 41842-44 e 41842-46



- 41842-42** Kupplungskopf, zur Aufnahme von max. 5 flexiblen  
 Spannarmen 41810-10  
 coupling head to hold 5 flexible arms 41810-10  
 cabeza de acoplamiento para fijar hasta 5 brazos flexibles  
 giunto per combinare 5 bracci



- 41842-44** Kupplungskopf, drehbar, zur Aufnahme von 1 flexiblen  
 Spannarm 41810-10  
 coupling head, turnable, to hold 1 flexible arm 41810-10  
 acoplamiento, girable y se puede fijar en todas las posturas  
 para sujetar un brazo flexible 41810-10  
 giunto per combinare, rotabile, per sostegno del braccio  
 41810-10  
**41842-46** Kupplungskopf, seitlich offen zur Aufnahme von 1 flexiblen  
 Spannarm 41810-10  
 coupling head, lateral open, to hold 1 flexible arm 41810-10  
 acoplamiento, abierto al lado, para un brazo flexible  
 41810-10  
 giunto per fissare il braccio, per 41810-10

LEYLA Retraktor System  
 LEYLA Retractor System  
 Separador de sistema LEYLA  
 LEYLA Sistema di fissaggio



- 41801-01 Hirnspatelhalter, flexibel, für 1 flachen Spatel, komplett, bestehend aus:  
 brain retractor, flexible, for 1 flat spatula, complete, consisting out of:  
 separador autoretentivo, flexible, para espátula con 1 brazo flexible,  
 completo, compuesto de:  
 divaricatore autostatico, flessibile, per spatole piatte, con 1 braccio flessibile, completo, composto da:
- 41810-10 flexibler Spannarm  
 flexible arm, only  
 brazo flexible, suelto  
 braccio flessibile, solo
- 41826-26 Fixiervorrichtung für 1 flexiblen Spannarm  
 fixation Base for 1 flexible arm  
 fijador para 1 brazo flexible  
 fissatore per 1 braccio al braccio rigido
- 41830-30 Spatelhalter für flache Spatel  
 support for flat brain spatula  
 soporte para espátulas cerebrales planas  
 sostegno per spatole piatte



- 41802-02 Hirnspatelhalter, flexibel für 2 flache Spatel, komplett, bestehend aus:  
 brain retractor, flexible, for 2 flat spatulas, complete, consisting out of:  
 separador autoretentivo, flexible, para 2 espátulas planas con 2 brazos flexibles, completo, compuesto de:  
 divaricatore autostatico, flessibile, per spatole piatte, con 2 bracci flessibili, completo, composto da:
- 41810-10 flexibler Spannarm (2x)  
 flexible arm, only (2x)  
 brazo flexible, suelto (2x)  
 braccio flessibile, solo (2x)
- 41822-22 Fixiervorrichtung für 2 flexible Spannarme  
 fixation Base for 2 flexible arms  
 fijador para 2 brazos al cráneo  
 fissatore per 2 bracci al cranio
- 41830-30 Spatelhalter für flache Spatel (2x)  
 support for flat brain spatula (2x)  
 soporte para espátulas cerebrales planas (2x)  
 sostegno per spatole piatte (2x)

LEYLA Retraktor System  
 LEYLA Retractor System  
 Separador de sistema LEYLA  
 LEYLA Sistema di fissaggio



- 41810-10 flexibler Spannarm  
 flexible arm, only  
 brazo flexible, suelto  
 braccio flessibile, solo

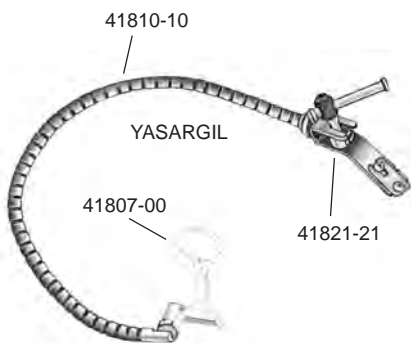

- 41803-01 Ohrspekulahalter, komplett, bestehend aus:  
 ear specula holder, complete, consisting out of:  
 soporte para especulos auriculares completo, compuesto de:  
 sostegno per specolo auricolare, completo composto da:
- 41810-10 flexibler Spannarm  
 flexible arm, only  
 brazo flexible, suelto  
 braccio flessibile, solo
- 41821-21 Fixiervorrichtung zum Befestigen an Rohrteilen bis Ø 16 mm  
 clamp for fixation on bars up to Ø 16 mm  
 fijador para 1 brazo flexible, para atornillar a tubos hasta 16 mm  
 fissatore al braccio rigido Ø 16 mm
- 41807-00 Ohrtrichterhalter, allein  
 ear specula holder, only  
 soporte para especulos auriculares, suelto  
 sostegno per specolo auricolare



**MAST.SH-GERMANY**

LEYLA Retraktor System  
LEYLA Retractor System  
Separador de sistema LEYLA  
LEYLA Sistema di fissaggio

41821-21

Fixiervorrichtung an Rohrteilen bis  $\varnothing$  16 mm, für 1 flexiblen Spannarm  
Fixation base for mounting on bars up to  $\varnothing$ 16 mm, for 1 flexible arm  
Fijador para 1 brazo flexible, para atornillar a tubos hasta 16 mm  
Fissatore per 1 braccio al braccio rigido



41822-22

Fixiervorrichtung am Schädel für 2 flexible Spannarme  
Fixation Base for skull mounting, holding 2 flexible arms  
Fijador para 2 brazos al cráneo  
Fissatore per 2 bracci al cranio



41826-26

Fixiervorrichtung am Schädel für 1 flexiblen Spannarm  
Fixation Base for skull mounting, holding 1 flexible arm  
Fijador para 1 brazo al cráneo  
Fissatore per 1 braccio al cranio



41830-30

Halter für flache Hirnspatel  
Support for flat brain spatula  
Soporte para espátulas cerebrales planas  
Sostegno per spatole piatte



41832-32

Halter für Hirnspatel mit rundem Schaft  
Support for brain spatula with round shaft  
Soporte para espátulas cerebrales con mango redondo  
Sostegno per spatola cerebrale







Hirnspatel  
Brain Spatulas  
Espátula Cerebral  
Spatole Cerebrali



HEIFETZ  
200 mm  
8"

Breite  
width  
ancho  
larghezza

Gesamtlänge  
total length  
largo total  
lunghezza totale

41860-14  
41860-17  
41860-20

14 mm  
17 mm  
20 mm

200 mm  
200 mm  
200 mm

biegsam  
malleable  
maleable  
malleabili



HEIFETZ  
155 mm  
6"

Breite  
width  
ancho  
larghezza

Gesamtlänge  
total length  
largo total  
lunghezza totale

41870-08  
41870-11  
41870-14  
41870-17

8 mm  
11 mm  
14 mm  
17 mm

155 mm  
155 mm  
155 mm  
155 mm

biegsam  
malleable  
maleable  
malleabili

Breite  
width  
ancho  
larghezza

Gesamtlänge  
total length  
largo total  
lunghezza totale

41880-01  
41880-02  
41880-03

9 mm  
12 mm  
12 mm

200 mm  
200 mm  
250 mm

biegsam  
malleable  
maleable  
malleabili



CUSHING  
200 mm, 8"

Lidsperrer  
 Eye Specula  
 Blefaróstatos  
 Blefarostati

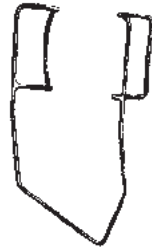

BARRAQUER (Colibri)

43101-03 3 cm, 1.2" für Kinder / children / niños / bambini  
 43101-04 4 cm, 1.6" für Erwachsene / adults / adultos / adulti



BOWMAN

43104-07 7 cm, 2 3/4"

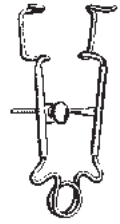

CRITCHETT

43105-06 7 cm, 2 3/4"

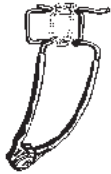

SMITH  
 43106-05 5 cm, 2"



CLARK  
 43107-08 8 cm, 3 1/8"



GRAEFE  
 43109-07 7 cm, 2 3/4"  
 43109-09 9 cm, 3 1/2"



WEEK  
 43110-08 8 cm, 3 1/8"

rechts  
 right  
 a la derecha  
 destro

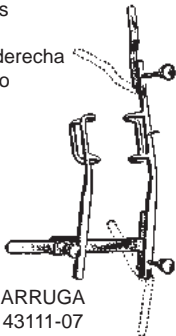

ARRUGA  
 43111-07 7 cm, 2 3/4"

links  
 left  
 a la izquierda  
 sinistro

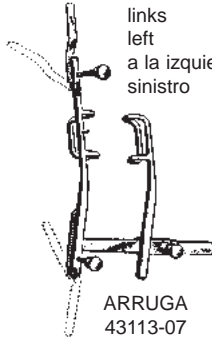

ARRUGA  
 43113-07 7 cm, 2 3/4"

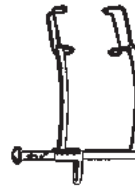

MURDOCK  
 43115-05 5 cm, 2"

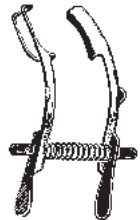

MELLINGER-AXENFELD  
 43121-07 7 cm, 2 3/4"

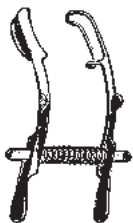

MELLINGER-AXENFELD  
 43123-07 7 cm, 2 3/4"



MELLINGER  
 43125-05 5 cm, 2"  
 43125-07 7 cm, 2 3/4"



LISTER-BURCH  
 43127-08 8 cm, 3 1/8"

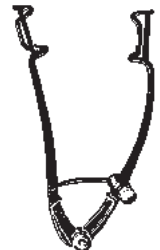

WILLIAMS  
 43128-08 8 cm, 3 1/8"

Lidsperrer, Lidplatte, Starmesser  
 Eye Specula, Lid Plate, Cataract Knives  
 Blefaróstatos, Placa para párpados, cuchillos para cataratas  
 Blefarostati, Placca per palpebre, coltelli per cataratta



LANCASTER  
 43129-07  
 7 cm, 2 3/4"



ZIEGLER  
 43130-07  
 7 cm, 2 3/4"



CASTROVIEJO  
 43132-08  
 8 cm, 3 1/8"

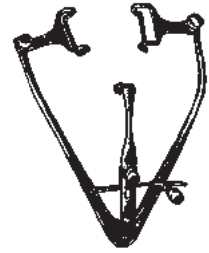

PARK  
 43133-08  
 8 cm, 3 1/8"



MUELLER  
 43135-07  
 7 cm, 2 3/4"



STEVENSON  
 43139-07  
 7 cm, 2 3/4"



LIEBERMAN  
 43140-08  
 8 cm 3 1/8"



LIEBERMAN  
 43141-08  
 8 cm 3 1/8"



JAEGER  
 43150-11  
 11 cm, 4 3/8"



GRAEFE  
 43170-00 - 43170-03  
 13 cm, 5 1/8"



43170-00



43170-01



43170-02



43170-03



DEUTSCHMANN  
 43172-13  
 13 cm, 5 1/8"



# MAST.SH-GERMANY

Lanzenmesser, Diszisionsmesser, Irismesser, Diszisionsmesser  
 Cataract knife, keratome, Iris knife, discision knife  
 Cuchillos lanceolares y Cuchillos de discisión  
 Cheratom, bisturi p. capsule, bisturi corneale



**JAEGER**  
 43180-01 Fig. 1 13 cm, 5 1/8"  
 43180-02 Fig. 2 13 cm, 5 1/8"  
 43180-03 Fig. 3 13 cm, 5 1/8"  
**JAEGER 45°**  
 43181-01 Fig. 1  
 43181-02 Fig. 2  
 43181-03 Fig. 3

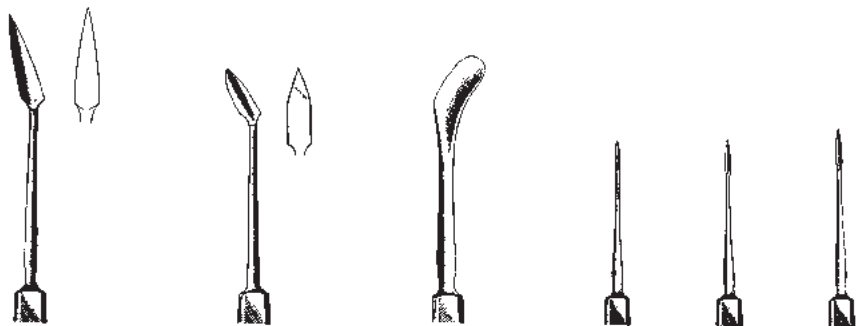

43180-01 - 43181-03  
**BERENS**  
 43183-13 13 cm, 5 1/8"  
**CASTROVIEJO**  
 43185-13 13 cm  
 4 x 13 mm  
**GRAEFE**  
 43187-13 13 cm, 5 1/8"  
**KNAPP**  
 43202-01 Fig. 1 13 cm, 5 1/8"  
 43202-02 Fig. 2 13 cm, 5 1/8"  
 43202-03 Fig. 3 13 cm, 5 1/8"



**ZIEGLER**  
 43210-01 5 mm Fig. 1 13 cm, 5 1/8"  
 43210-02 6 mm Fig. 2 13 cm, 5 1/8"  
 43210-03 7 mm Fig. 3 13 cm, 5 1/8"  
**DEAN**  
 43213-12 12,5 cm, 5"  
**BOWMAN**  
 43214-04 13 cm, 0,4 mm Fig. 1 13 cm, 5 1/8"  
 43214-08 13 cm, 0,8 mm Fig. 2 13 cm, 5 1/8"

Hornhautmesser, Hornhautschaber, Dissektor, Sklerotom, Goniotomiemesser  
 Corneal Scarifier, -dissector, sclerotome, goniotomy knife  
 Cuchillos para cornea, legtras corneales, esclerótomos  
 Spatole p. corneale, dissettore corneale, sclerotomo, coltello per goniotomia



WHEELER  
43218-12  
12 cm, 4 3/4"



ZIEGLER  
43221-11  
11 cm, 4 3/8"  
3,5 mm



SATO  
43226-12  
12,5 cm, 5"



TOOK  
43228-12  
12 cm, 4 3/4"



GILL  
43231-12  
12 cm, 4 3/4"



ELSCHMIG  
43233-13  
13 cm, 5 1/8"



KUHNT  
43240-01  
Fig. 1



KUHNT  
43240-02  
Fig. 2



KUHNT  
43240-03  
Fig. 3



KUHNT  
43240-04  
Fig. 4



PATON  
43245-12  
12 cm, 4 3/4"



LUNDSGAARD  
43251-12  
12 cm, 4 3/4"



GUYTON-  
LUNDSGAARD  
43253-12



BARKAN  
43256-12



SCHEIE  
43258-12



BURCH  
43262-12



PAUFIGUE  
43271-11



BARRAQUER  
43273-13

Diszisionsnadeln, Fremdkörpernadeln, Fremdkörperhohlmeißel  
 Discision Needles, Foreign-Body Instruments  
 Aguja de discisión, Instrumental para cuerpos extraños  
 Aghi per discisione, strumenti per corpi estranei



43304-12



43305-12



BOWMAN  
43308-12



BOWMAN  
43309-12



43310-13



43311-13



LEVINSON  
43314-13



FRANCIS  
43321-12



DAVIS  
43325-13



LA FORCE  
43327-12



DIX  
43330-13



ELLIS  
43331-11



WALTON  
43332-12  
1,4 mm



WALTON  
43334-12  
1,4 mm



ALVIS  
43336-12



GREEN  
43340-13



ROLLET  
43342-12

Schielhaken, Tenotomiehaken, Extraktionshaken, Tränensackhäkchen  
 Strabismus hook, lens hook, extraction hook  
 Ganchos para estrabismo, - cristalino, extracción  
 Uncino per il strabismo, uncino p. cristallino, protettori, uncini per l'iride



Fig. 1  
 GRAEFE  
 43351-01  
 13 cm, 5 1/8"



Fig. 2  
 GRAEFE  
 43351-02  
 14 cm, 5 1/2"



Fig. 3  
 GRAEFE  
 43351-03  
 15 cm, 6"



JAMESON  
 43353-13



GREEN  
 43355-13



STEVENS  
 43357-13



Fig. 1  
 ARRUGA  
 43363-01



Fig. 2  
 ARRUGA  
 43363-02



O'CONNER  
 43370-12



WIENER  
 43372-13



WIENER  
 43373-13



ROLLET  
 43376-13



KNAPP  
 43377-13



GRAEFE  
 43380-13



GRAEFE  
 43381-13



GRAEFE  
 43383-13



BECKER  
 43386-13

Implantations Instrumente  
 Instruments for Implantation  
 Instrumentos para implantación  
 Strumenti per impianto

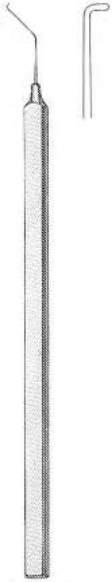

CLAYMAN  
 43387-02  
 11,5 cm 4 1/2"



SINSKEY  
 43388-02  
 11,4 cm 4 1/2"



SINSKEY  
 43389-02  
 12 cm 4 3/4"



KUGLEN

43390-05  
 11,7 cm 4 5/8"

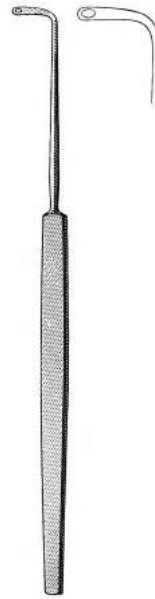

GASS  
 43391-13  
 14,6 cm 5 3/4"





Küretten und Löffel für Chalazion und Star  
Scoops and Curettes for Chalazio, Cataract, and Exenteration  
Curetas y cucharillas para chalazión, catarata y exenteración  
Curette e cucchiari per calazio, cateratta e palpebre

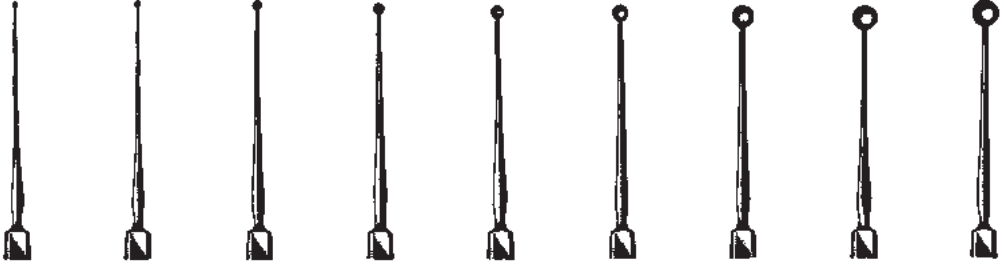

MEYHOEFER

	43402-05	43402-10	43402-15	43402-18	43402-20	43402-25	43402-35	43402-40	43402-45
Ø mm	0,5	1,0	1,5	1,8	2,0	2,5	3,5	4,0	4,5



	HEBRA	HEBRA	HEBRA	HEBRA	HEBRA
	43404-10	43404-20	43404-24	43404-30	43404-35
Ø mm	1,0	2,0	2,5	3,0	3,5



AXENFELD  
43407-13



GRAEFE  
43410-01



GRAEFE  
43410-02



DAVIEL  
43412-01  
3 mm



DAVIEL  
43412-02  
4 mm

Starlöffel, Exenterationslöffel, Drahtschlingen, Starschlingen, Irisspatel, Enukleationslöffel, Wundlöffel  
 Cataract Spoon, Exenteration Scoops, Lens Scoops, Spatulas, Protectores  
 Cucharillas para Catarata-, exenteración, Asas, Espátulas, Protectores  
 Cucchiaino per cataratta- esenterazione, Anse, Spatole, Protettori



KNAPP  
43414-02



BUNGE  
43420-01



BUNGE  
43420-02



BUNGE  
43420-03



LANG  
43424-13



WEBER  
43441-01  
Fig. 1



43441-02  
Fig. 2



SNELLEN  
43443-13



43445-13  
Fig. 1



43447-13  
Fig. 2



ARLT



43449-01



43449-02

Cautery  
Cauter  
Cauterio

Iris  
Iride



WECKER  
43461-13



WECKER  
43462-13



CULLER  
43467-13



WELLS  
43482-20



ARRUGA  
43485-13



WADSWORTH-TODD  
43487-14



Zyklodialysespatel, Fremdkörperinstrumente  
Cyclodialysis Spatula, Foreign Body Instruments  
Espátulas para ciclodiálisis, Instrumentos para cuerpos extraños  
Spatole per ciclodialisi, Strumenti per corpi estranei



BANGERTER



43501-06  
6 mm



43501-10  
10 mm



43501-12  
12 mm



43511-13 - 43517-09



CASTROVIEJO  
43511-13  
1,2 x 10 mm



CASTROVIEJO  
43513-14  
1,5 x 15 mm



ELSCHNIG  
43515-14  
1,2 x 12 mm



CASTROVIEJO  
43517-09  
0,8 x 15 mm

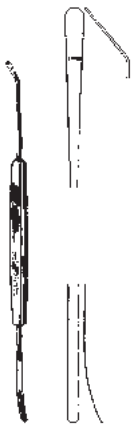

CASTROVIEJO  
43521-12  
12 cm, 4 3/4"



WHEELER  
43523-12  
12 cm, 4 3/4"



HIRSCHMAN  
43524-10  
12,5 cm, 5"



CASTROVIEJO  
43525-05 0,50 mm  
43525-07 0,75 mm  
43525-10 1,00 mm



BECHERT  
43526-12  
12,5 cm, 5"

Fremdkörperinstrumente, Meßzirkel, Kapselstanze  
 Foreign- Body Instruments, Markers, Corneoscleral punch  
 Instrumental para cuerpos extraños, Compás de la cápsula, Pinza para capsuloiridectom  
 Strumenti per corpi estranei, Marcatori, Pinza per capsula



DIX  
43542-12



DIX  
43544-12

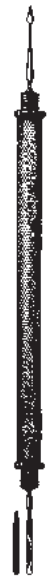

DIX  
43546-13



DIX  
43548-13



CASTROVIEJO  
43583-07 0-20 mm  
7 cm, 2 3/4"



CONNIN-AMSLER  
43589-13



HOLTH  
43593-09



Tränenkanaldilatatoren, Sonden  
 Lachrymal Dilators-, Probes  
 Diladores, Estiletos para canal lacrimal  
 Dilatori e Specilli per canale lacrimale



WILDER  
43602-01



WILDER  
43602-02



WILDER  
43602-03



Fig. ZIEGLER  
 1/2 43605-12  
 3/4 43605-34  
 5/6 43605-56



CASTROVIEJO  
43608-12

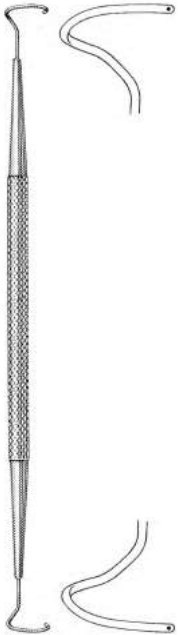

WORST  
43609-14  
14,9 cm 5 7/8"

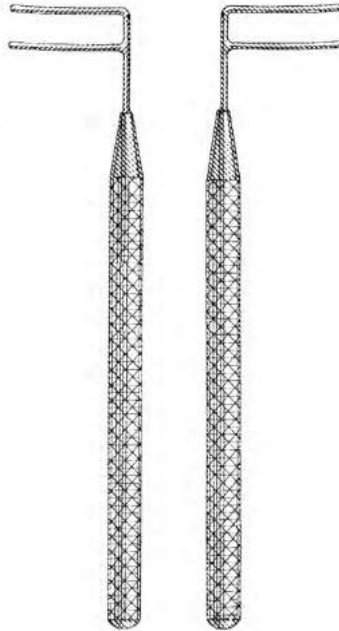

HARMS  
43610-01 43610-02  
4,8 cm 1 7/8"

gekknöpft



rostfrei  
stainless steel  
acero inoxidable  
acciaio inossidabile

Fig.	BOWMAN	Ø mm
0000/000	43613-00	0,6/0,7
00/0	43614-00	0,7/0,8
0/1	43614-01	0,8/0,9
1/2	43614-12	0,9/1,1
2/3	43614-23	1,1/1,3
3/4	43614-34	1,3/1,4
4/5	43614-45	1,4/1,5
5/6	43614-56	1,5/1,6
6/7	43614-67	1,6/1,8
7/8	43614-78	1,8/1,9



# MAST.SH-GERMANY

Iris Pinzetten  
Iris Forceps  
Pinzas para iris  
Pinze per iride



GRAEFE  
43802-07  
7 cm (2 3/4")/1 mm



GRAEFE  
43803-07  
7 cm (2 3/4")/1 mm

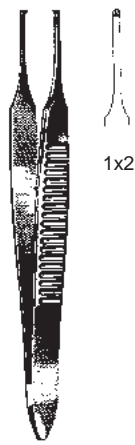

GRAEFE  
43804-07  
7 cm (2 3/4")/1 mm

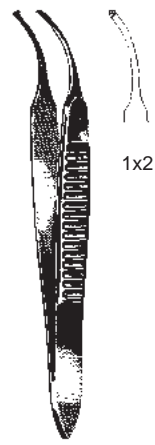

GRAEFE  
43805-07  
7 cm (2 3/4")/1 mm



GRAEFE  
43810-10  
10 cm  
4"



GRAEFE  
43811-10  
10 cm  
4"



GRAEFE  
43813-10  
10 cm  
4"



GRAEFE  
43820-10  
10 cm  
4"



GRAEFE  
43821-10  
10 cm  
4"



GRAEFE  
43823-10  
10 cm  
4"

Iris Pinzetten  
 Iris Forceps  
 Pinzas para iris  
 Pinze per iride



STEVENS  
 43830-10  
 10,5 cm, 4.1"



STEVENS  
 43831-10  
 10,5 cm  
 4.1"



STEVENS  
 43833-10  
 10,5 cm  
 4.1"



STEVENS  
 43840-10  
 10,5 cm  
 4.1"



STEVENS  
 43841-10  
 10,5 cm  
 4.1"



STEVENS  
 43843-10  
 10,5 cm  
 4.1"



FOERSTER  
 43850-08  
 8,5 cm, 3.4"



FOERSTER  
 43851-08  
 8,5 cm, 3.4"



FOERSTER  
 43852-08  
 8,5 cm, 3.4"

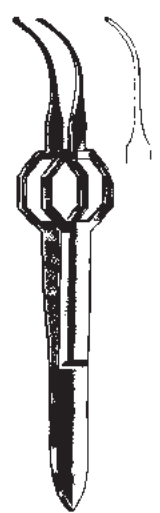

FOERSTER  
 43853-08  
 8,5 cm, 3.4"

Iris Pinzetten  
Iris Forceps  
Pinzas para iris  
Pinze per iride

seitliche Zähne  
lateral teeth  
dientes laterales  
denti laterali

Zähne abwärts  
teeth below  
dientes abajo  
denti in basso



HESS  
43855-07  
7 cm (2 3/4")/  
0,3 mm



HESS  
43857-07  
7 cm (2 3/4")/  
0,3 mm



GILL  
43861-07  
7,5 cm (3")/  
0,3 mm



GILL-HESS  
43863-07  
7,5 cm (3")/  
0,3 mm



GILL-HESS  
43865-07  
7,5 cm (3")/  
0,3 mm

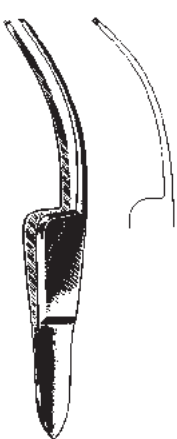

FISCHER  
43869-07  
7 cm (2 3/4")



BARRAQUER-KATZIN  
43881-07  
7 cm (2 3/4")/0,4 mm



TROUTMAN (Colibri)  
43883-07  
7 cm (2 3/4")/0,12 mm



BARRAQUER (Colibri)  
43885-07  
7 cm (2 3/4")/0,12 mm



BARRAQUER (Colibri)  
43887-07  
7 cm (2 3/4")/0,12 mm



Fixierpinzette, Strabismus-Pinzetten  
 Fixation forceps, Strabismus-Forceps  
 Pinza para fijación, Pinzas para estrabismo  
 Pinza per fissatrice, Pinze per strabismo



**KIRBY-ARTHUR**  
 43891-09 9 cm, 3 1/2"  
 0,2 mm



**McCULLOUGH**  
 43902-09  
 9,5 cm, 3 3/4"



**McCULLOUGH**  
 43903-09  
 9,5 cm, 3 3/4"

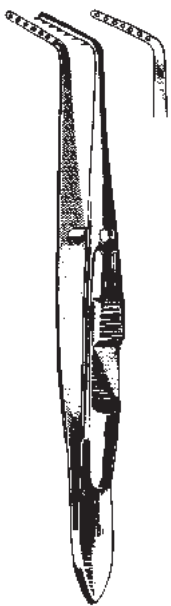

**JAMESON**  
 43907-10  
 L, 10 cm, 4"

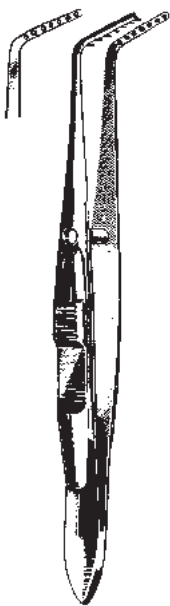

**JAMESON**  
 43909-10  
 R, 10 cm, 4"



**BONACCOLTO**  
 43914-10  
 10 cm, 4 1/1,7 mm



**BONACCOLTO**  
 43916-10  
 10 cm, 4 1/1,2 mm



**BONACCOLTO**  
 43920-11  
 11 cm, 4 3/8"



# MAST.SH-GERMANY

Strabismus-Pinzetten, Iris Pinzetten  
Strabismus-Forceps, Iris Forceps  
Pinzas para estrabismo, Pinzas para iris  
Pinze per strabismo, Pinze per iride



DASTOOR  
43924-11  
11 cm, 4 3/8"



DASTOOR  
43926-11  
11 cm, 4 3/8"



BISHOP-HARMAN  
43940-05 8,5 cm, 3.4"  
0,5 mm



BISHOP-HARMAN  
43940-08 8,5 cm, 3.4"  
0,8 mm



BISHOP-HARMAN  
43942-05 8,5 cm, 3.4"  
0,5 mm

1x2



BISHOP-HARMAN  
43942-08 8,5 cm, 3.4"  
0,8 mm

1x2



Iris Pinzetten, Nahtpinzetten, Muskelpinzetten  
Iris, Suture forceps, Muscle Forceps  
Pinzas para iris, Pinza para sutura, Pinzas musculares  
Pinze per iride, Pinza per sutura, muscolari

mit Führungsstift  
with guide pin  
con perno guida  
con perno di guida

ohne Führungsstift  
without guide pin  
sin perno guida  
senza perno di guida



MOD. BONN  
43944-07  
7 cm, 2 3/4"  
0,12 mm

MOD. BONN  
43946-07  
7 cm, 2 3/4"  
0,12 mm

MOD. BONN  
43948-10  
10 cm, 4"  
0,12 mm



MOD. TÜBINGEN  
43950-10  
10 cm, 4"

MOD. BONN  
43952-10  
10 cm, 4"/0,12 mm

MOD. TÜBINGEN  
43953-10  
10 cm, 4"

PRINCE  
43955-10  
10 cm, 4"

PRINCE  
43956-10  
10 cm, 4"

Muskelpinzetten, Fixationspinzetten  
 Muscule Forceps, Fixation Forceps  
 Pinzas musculares, Pinzas para fijación  
 Pinze muscolari, Pinze per fissaggio

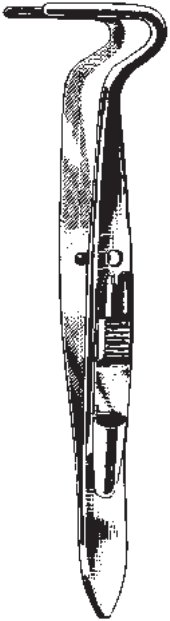

**BERKE**  
 44015-20 - 44015-27  
 10 cm, 4"

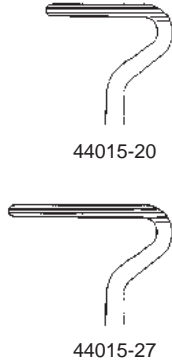

1x2

**TROUTMAN**  
 44017-08 8,5 cm, 3.4"  
 0,8 mm



**ELSCHNIG**  
 44046-11  
 11 cm, 4 2/8"



**GRAEFE**  
 44050-11 - 44052-11  
 11 cm, 4 2/8"



44050-11



44052-11  
 mit Sperre  
 with catch  
 con cierre  
 c. cremagliera



**LESTER**  
 44054-09  
 9 cm, 3 1/2"



Fixierpinzetten, Kapselpinzette  
Fixation forceps, capsular forceps  
Pinzas para fijación, Pinzas capsulares  
Pinze fissatrici, Pinze per capsulari



1x1

**CASTROVIEJO**  
44066-09  
9 cm, 3 1/2"



1x1

**CASTROVIEJO**  
44067-09  
9 cm, 3 1/2"



2x2

**CASTROVIEJO**  
44068-09  
9 cm, 3 1/2"



2x2

**CASTROVIEJO**  
44069-09  
9 cm, 3 1/2"



**BARRAQUER**  
44074-10  
10 cm, 4"



**GREEN**  
44076-05 - 44078-10  
10 cm, 4"



44076-05  
5 mm



44076-10  
10 mm

ohne Sperre  
without catch  
sin cierre  
senza cremagliera



44078-05  
5 mm



44078-10  
10 mm

mit Sperre  
with catch  
con cierre  
con cremagliera



**GILL-ARRUGA**  
44101-07  
7,5 cm, 3"

Kapselpinzetten  
Capsular Forceps  
Pinzas capsulares  
Pinze capsulare



**TERSON**  
44103-09  
9 cm, 3 1/2"



**KALT**  
44106-10  
10 cm, 4"



**ELSCHNIG**  
44109-10  
10 cm, 4"



**ARRUGA**  
44111-10  
10 cm, 4"



**ARRUGA**  
44114-10  
10 cm, 4"



**CASTROVIEJO**  
44115-10  
10 cm, 4"



**SCHWEIGGER**  
44117-10  
10 cm, 4"



**SCHWEIGGER**  
44119-10  
10 cm, 4"



**ELSCHNIG**  
44121-10  
10 cm, 4"



**HESS**  
44125-06  
6 cm, 2.4"



**HESS**  
44127-06  
6,5 cm, 2.6"



**FUCHS**  
44129-07  
7 cm, 2 3/4"

Nahtpinzetten, Fadenpinzetten  
 Suture Forceps, Tying Forceps  
 Pinzas para suturas y hilo  
 Pinze per sutura, Pinze per filo



**CASTROVIEJO**

10 cm, 4"

- 44150-01 0,12 mm
- 44150-03 0,30 mm
- 44150-05 0,50 mm
- 44150-10 1,00 mm
- 44150-15 1,50 mm

Zahn  
tooth  
diente  
dente



**CASTROVIEJO**

10 cm, 4"

- 44151-05
- 44151-10
- 44151-15



**MOORFIELD**

44164-10  
10 cm, 4"



**St. MARTIN**

44166-07  
7 cm, 2 3/4"



**Mod. TÜBINGEN**

44181-10  
10 cm, 4"



**PAUFIQUE**

44190-08  
8,5 cm, 3.4"



**PAUFIQUE**

44202-08  
8,5 cm, 3.4"

1x2



**McPHERSON**

44210-10  
10 cm, 4"



**McPHERSON**

44220-10  
10 cm, 4"

Pinzetten für Chalazion und Trachom  
 Forceps for Chalazion and Trachoma  
 Pinzas de chalazión y para tracoma  
 Pinze per calazio e per trichiasi



AYER  
 44240-09  
 9 cm, 3 1/2"

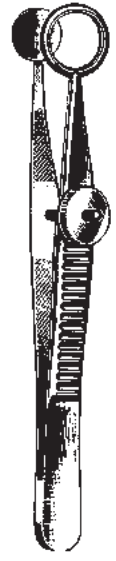

AYER  
 44242-09  
 9 cm, 3 1/2"



LAMBERT  
 44246-09  
 9 cm, 3 1/2"



DESMARRES  
 44254-09 - 44258-09  
 9 cm, 3 1/2"



44254-09 20 mm  
 Fig. 1

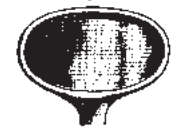

44256-09 24 mm  
 Fig. 2



44258-09 32 mm  
 Fig. 3

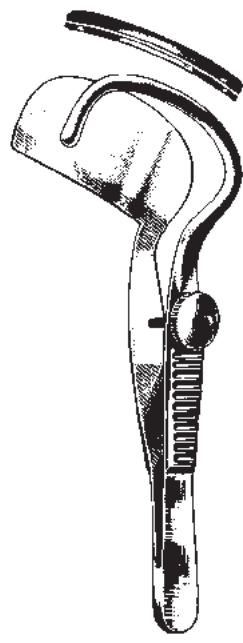

SNELLEN  
 44265-10 10 cm, 4"

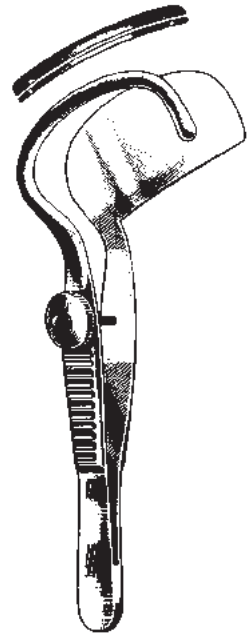

SNELLEN  
 44267-10 10 cm, 4"

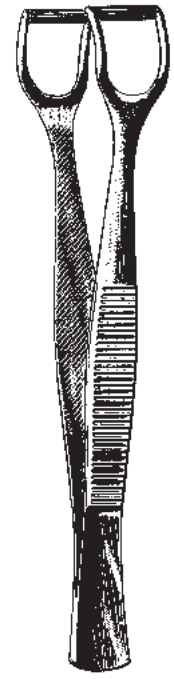

KNAPP-LUER  
 44274-11 11 cm, 4 3/8"



Augenkanülen  
 Eye Cannulas  
 Cánulas oculares  
 Cannule oculistiche

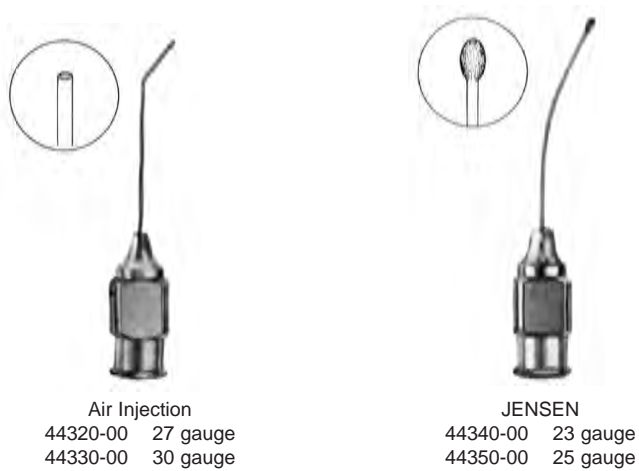
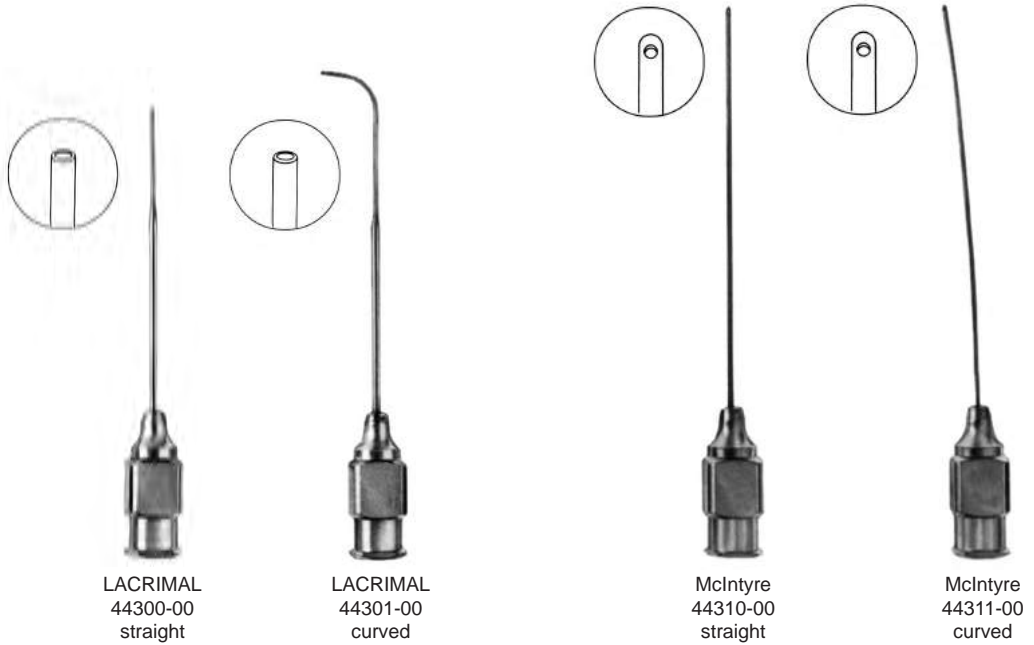

Spül- und Saugkanülen, Augenkanülen  
Irrigation and Aspiration Cannulas, Eye Cannulas  
Cánulas de irrigación y aspiración, Cánulas oculares  
Cannule per irrigazione ed aspirazione, Cannule oculistiche



**BISHOP-HARMON**

- 44370-00 complete
- 44371-00 silicone bulb
- 44372-00 adaptor
- 44373-00 19 gauge cannula
- 44374-00 21 gauge cannula

Augenkanülen, Tonometer  
 Eye Cannulas, Tonometer  
 Cánulas oculares, Tonómetro  
 Cannule oculistiche, Tonometro



SHEETS  
44380-00

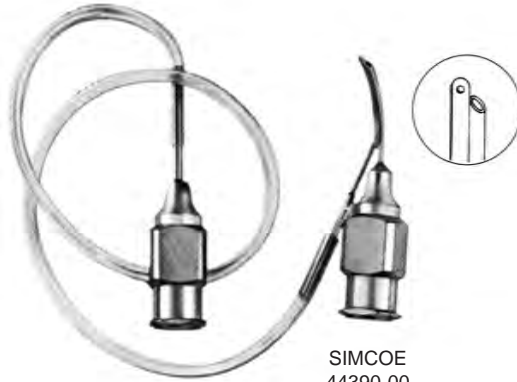

SIMCOE  
44390-00



	SCHIOETZ	
	44404-00	44406-00
Skala	gerade	schräg
scale	straight	oblique
escala	recta	oblícua
scala	retta	obliqua

Augenmagnet, Cilienpinzetten  
 Eye Magnet, Cilia Forceps  
 Imàn para cuerpos extraños, Pinzas depilatorias  
 Calamita per corpi estranei, Pinze depilatorie



REDA  
44408-00



BEER  
44420-09  
9 cm, 3 1/2"



DOUGLAS  
44422-09  
9 cm, 3 1/2"



LITTAUER  
44424-08  
8,5 cm, 3.4"



BARRAQUER  
44425-10  
10,5 cm, 4.1"



REDA  
44426-09  
9 cm, 3 1/2"



GRADLE  
44428-09  
9,5 cm, 3 3/4"



## Ohrspekula Ear Specula Espéculos auriculares Specoli auricolari



**POLITZER**  
45009-00  
Set = 3

Innen Ø  
○ = 2 mm  
45009-02

○ = 3 mm  
45009-03

○ = 4 mm  
45009-04

schwarz  
black  
negro  
nero



**HARTMANN**  
45011-00  
Set 3-7 mm

Innen Ø  
○ = 3 mm  
45011-03

○ = 4 mm  
45011-04

○ = 5 mm  
45011-05

○ = 7 mm  
45011-07

○ = 8 mm  
45011-08



**HARTMANN**  
45010-00  
Set = 4

Innen Ø  
○ = 2 mm  
45010-20

○ = 3 mm  
45010-30

○ = 4,5 mm  
45010-45

○ = 5,5 mm  
45010-55

○ = 6,5 mm  
45010-65

○ = 7,5 mm  
45010-75



**TOYNBEE**  
45012-00  
Set = 3

Innen Ø  
○ = 4 mm  
45012-40

○ = 5,5 mm  
45012-55

○ = 6,5 mm  
45012-65

○ = 7,5 mm  
45012-75



**GRUBER, rund**  
45014-00  
Set = 4

Innen Ø  
○ = 4,5 mm  
45014-45

○ = 5,5 mm  
45014-55

○ = 6,5 mm  
45014-65

○ = 7,5 mm  
45014-75



**GRUBER, oval**  
45015-00  
Set = 4

Innen Ø  
○ = 4,5 mm  
45015-45

○ = 5,5 mm  
45015-55

○ = 6,5 mm  
45015-65

○ = 7,5 mm  
45015-75



**BOUCHERON**  
45018-00  
Set = 4

Innen Ø  
○ = 5 mm  
45018-50

○ = 6 mm  
45018-60

○ = 7 mm  
45018-70

○ = 8 mm  
45018-80



**MAST.SH-GERMANY**

Ohrspekula  
Ear Specula  
Espéculos auriculares  
Specoli auricolari

○  
45020-01  
Ø 3 mm

○  
45020-02  
Ø 4 mm

○  
45020-03  
Ø 5 mm

○  
45020-04  
Ø 6 mm



RICHNAU-HOLMGREN



**MAST.SH-GERMANY**

Ohrspekula  
Ear Specula  
Espéculos auriculares  
Specoli auricolari

6,5 mm



45030-06

7,5 mm



45030-07

8,2 mm



45030-08

10 mm



45030-10

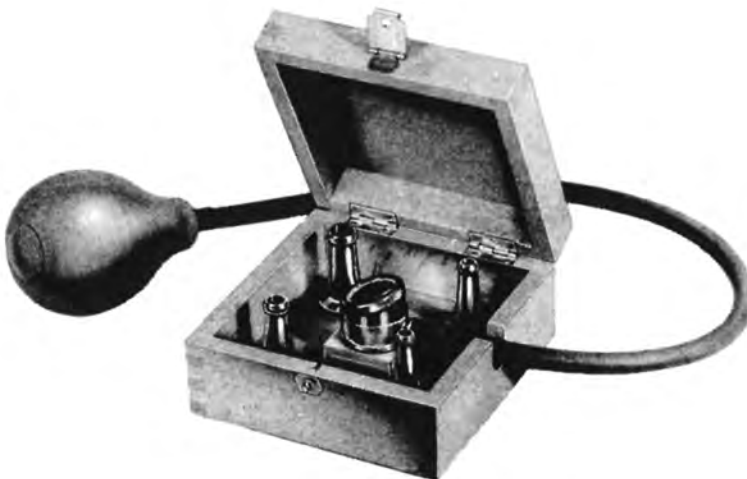

BRUENINGS  
45030-04  
compl.

Komplett bestehend aus:  
4 Spekula, Saugkammer mit  
Gebläse, Holzetui

Complete consisting of:  
4 specula, suction head and rubber  
tube with bulb, wooden case

Compuesto de:  
4 espéculos, cámara de aspiración,  
insuflador de goma, en estuche de  
madera

Composta da:  
4 specoli, camera aspirante con  
soffiatrice, scatola di legno

Ersatzteile / spare parts /  
repuestos / pezzi di ricambio

**45036-09**

Lupe / Magnification glass /  
lupa / lente d'ingrandimento

**45036-10**

Saugpumpe / rubber ball /  
pera de goma / soffiatrice di gomma



**MAST.SH-GERMANY**

Ohrspekula  
Ear Specula  
Espéculos auriculares  
Specoli auricolari



6,5 mm Ø



45036-06



7 mm Ø



45036-07



8 mm Ø



45036-08

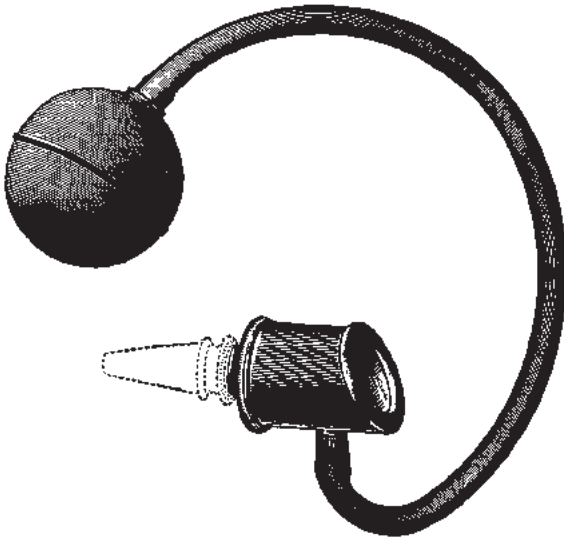

SIEGLE  
45036-03  
compl.

Komplett bestehend aus:  
Ohrspekulum, 3 Spekula, 1 Gebläse

Complete consisting of:  
Ear Specula, 1 rubber tube with bulb

Compuesto de:  
Otoscopio con 3 espéculos, insuflador y tubo

Composta da:  
Otoscopio con 3 specoli e 1 insufflatore con tubo



Stimmgabeln  
Tuning Forks  
Diapasones  
Diapason

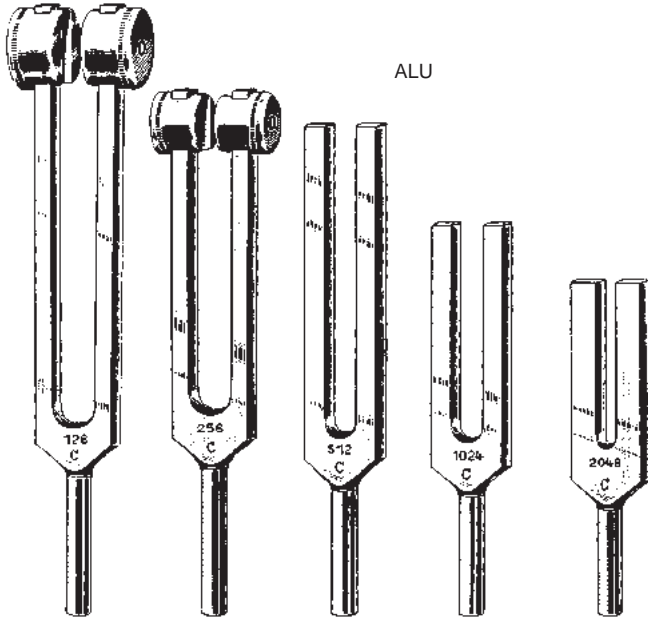

ALU



45060-01  
C 128

45060-02  
C<sup>1</sup> 256

45060-03  
C<sup>2</sup> 512

45060-04  
C<sup>3</sup> 1024

45060-05  
C<sup>4</sup> 2048

45061-00  
compl.

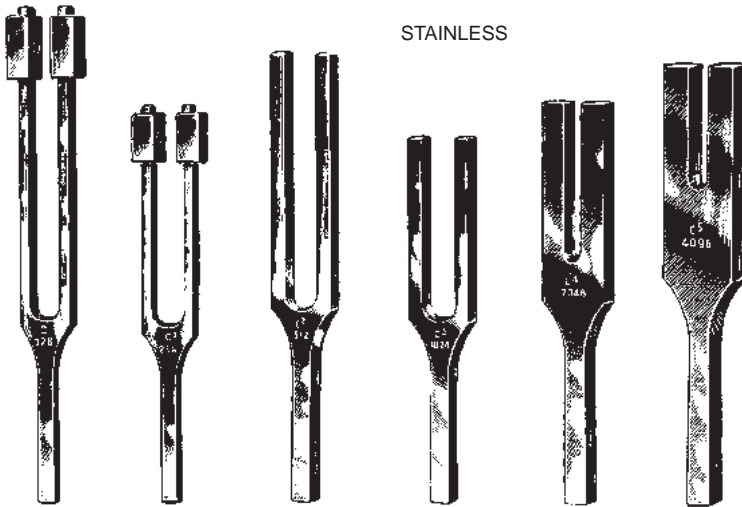

STAINLESS



45070-01  
C 128

45070-02  
C<sup>1</sup> 256

45070-03  
C<sup>2</sup> 512

45070-04  
C<sup>3</sup> 1024

45070-05  
C<sup>4</sup> 2048

45070-06  
C<sup>5</sup> 4096

HARTMANN

45071-00  
compl.

Stimmgabeln  
Tuning Forks  
Diapasones  
Diapason



45072-01  
a¹ 440



LUCAE  
45073-01 C 128  
45073-02 C¹ 256  
45073-03 C² 512  
45073-04 C³ 1024  
45073-05 C⁴ 2048  
45073-06 C⁵ 4096



LUCAE  
45074-01  
C 128



45075-00

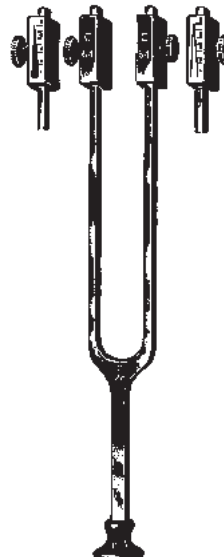

RYDEL-SEIFFERT  
45076-01 C 128 / C 64

Lärmtrommel, Pulverbläser  
 Noise Apparatus, Powder Blowers  
 Ensordecedor, Lanzapolvero  
 Assorditore, Insoffiatori per polvere



BARANY  
45080-00

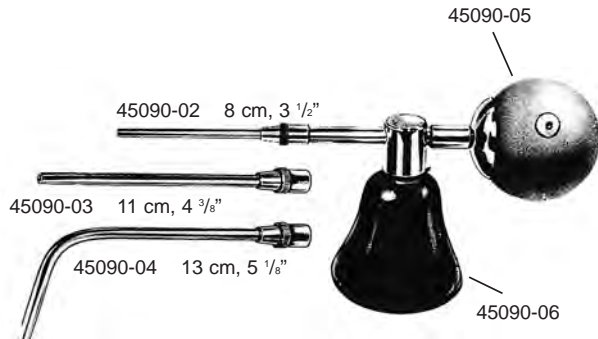

KABIERSKE  
45090-00 compl.  
30 cc

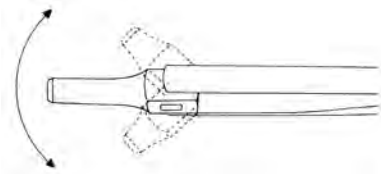

Universal  
45090-08

Komplett mit beweglicher Düse,  
 Schraubflasche 30 ccm und Halbgebläse  
 complete with movable tube, screw bottle  
 30 ccm and rubber bulb  
 completo con tubo móvil botella con rosca  
 30 ccm y pera de goma  
 completo con tubo mobile, bottiglia con  
 filettatura 30 ccm e pera di insufflazione



# MAST.SH-GERMANY

Luftdusche, Ohrspritze  
 Air Bag, Ear Syringe  
 Insuflador de aire, Jeringa  
 Insoffiatore d'aria, Siringa Auricolare

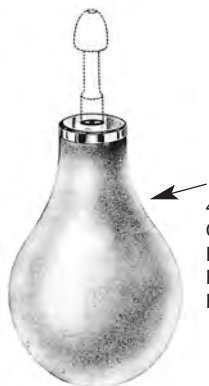

45091-02  
 Gummibirne alleine  
 Rubber bulb only  
 Pera de goma, sola  
 Pera di gomma, sola



45091-03



45091-04  
 4 mm Ø



45091-15  
 15 mm Ø



45091-17  
 17 mm Ø



45091-22  
 22 mm Ø

POLITZER  
 45091-00 Set  
 incl.  
 45091-03  
 45091-15  
 45091-17  
 45091-22

POLITZER  
 45091-01 Set  
 incl.  
 45091-03  
 45091-04  
 45091-15  
 45091-17  
 45091-22



ml REINER  
 compl.  
 50 45096-50  
 75 45096-75  
 100 45097-10  
 150 45097-15



45097-01



45097-02



45097-03



**MAST.SH-GERMANY**

Spritze, Küretten  
 Syringe, Curettes  
 Jeringa, Curetas  
 Siringa, Curette



45098-01 1 ml  
 45098-02 2 ml  
 45098-05 5 ml  
 45098-10 10 ml  
 45098-20 20 ml  
 45098-50 50 ml

45099-01 1 ml  
 45099-02 2 ml  
 45099-05 5 ml  
 45099-10 10 ml  
 45099-20 20 ml  
 45099-50 50 ml



Küretten  
 Curettes  
 Curetas  
 Curette



Fig. 00      0      1      2      3      4      5

stumpf  
 blunt  
 romas  
 smusse



45109-00    45110-00    45110-01    45110-02    45110-03    45110-04    45110-05

scharf  
 sharp  
 cortantes  
 taglianti



45111-00    45112-00    45112-01    45112-02    45112-03    45112-04    45112-05

stumpf  
 blunt  
 romas  
 smusse



45114-00    45115-00    45115-01    45115-02    45115-03    45115-04    45115-05

scharf  
 sharp  
 cortantes  
 taglianti



45116-00    45117-00    45117-01    45117-02    45117-03    45117-04    45117-05

BUCK  
 14,5 cm, 5 3/4"



# MAST.SH-GERMANY

Ohrkatheter, Parazentese Nadeln, Ohrmesser  
 Catheters, Paracentesis Needles, Ear Knives  
 Cateteres, agujas para paracentesis, Cuchillos auriculares  
 Cateteri, Aghi per paracentesi, Coltelli auricolari

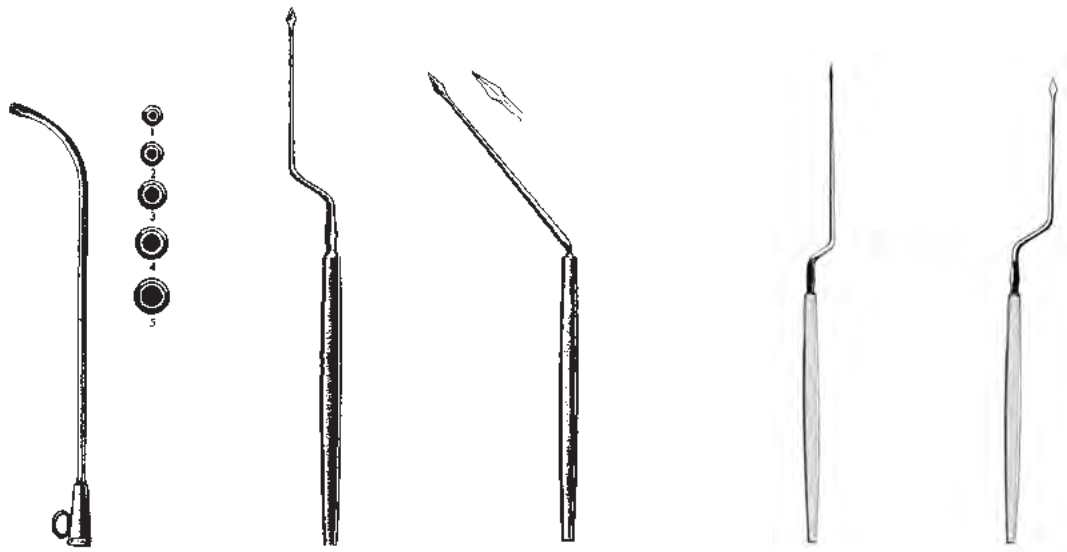

Fig. HARTMANN

- 1 45133-01 3,5 mm
- 2 45133-02 4,0 mm
- 3 45133-03 4,5 mm
- 4 45133-04 5,0 mm
- 5 45133-05 6,0 mm

POLITZER  
 45150-18  
 18 cm, 7"

POLITZER  
 45151-16  
 16,5 cm, 6 1/2"

LUCAE  
 45152-01  
 18 cm, 7"

LUCAE  
 45152-02  
 18 cm, 7"

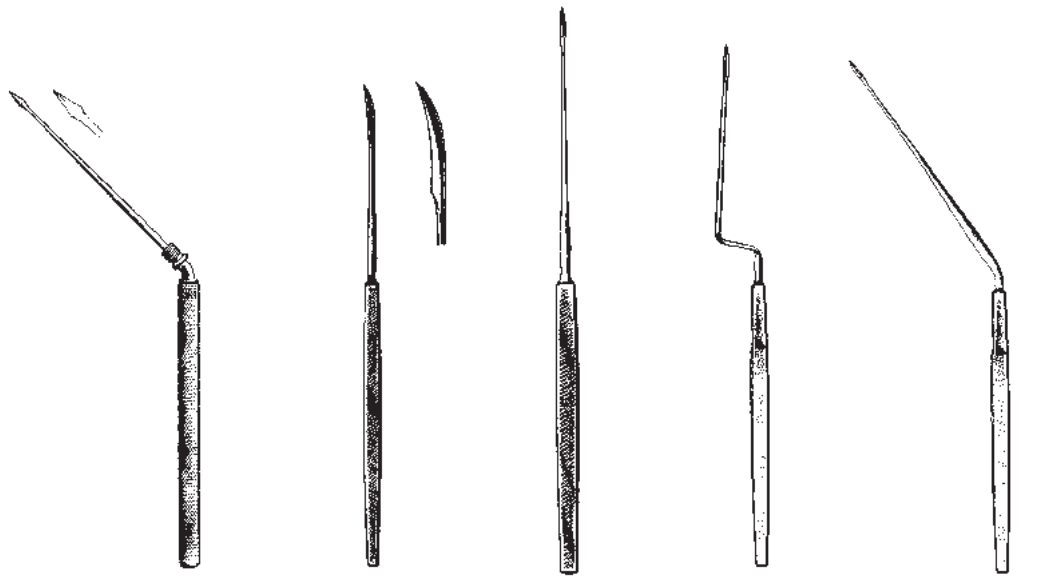

POLITZER  
 45153-16  
 16 cm, 6 1/4"

POLITZER  
 45160-15  
 15 cm, 6"

SEXTON  
 45162-18  
 18 cm, 7"

SEXTON  
 45164-17  
 17 cm, 6 3/4"

SEXTON  
 45165-17  
 17 cm, 6 3/4"



**MAST.SH-GERMANY**

Löffel, Schlingen, Häkchen  
Ear spoons, Loops, Hooklets  
Cucharas, Asas, Ganchitos  
Cucchiai, Anse, Uncinetti



**GROSS**  
45171-12  
12 cm, 4 3/4"



**BILLEAU**  
45180-01 - 45180-03  
16 cm, 6 1/4"



45180-01



45180-02



45180-03



**LANGENBECK**  
45181-13  
13 cm, 5 1/8"



**ZAUFAL**  
45184-16  
16 cm, 6 1/4"



**ZAUFAL-JANSEN**  
45185-15  
15 cm, 6"



**DAY**  
45190-01 - 45190-02  
16 cm, 6 1/4"



45190-01



45190-02



**WAGENER**  
45192-01 - 45192-04  
14 cm, 5 1/2"



45192-01



45192-03



45192-02



45192-04



45192-05



45192-06



**LUCAE**  
14 cm, 5 1/2"



45193-01  
2 mm



45193-02  
3 mm



45193-03  
4 mm

Schlingen, Pinzetten  
 Loops, Dressing Forceps  
 Asas, Pinzas  
 Anse, Pinze

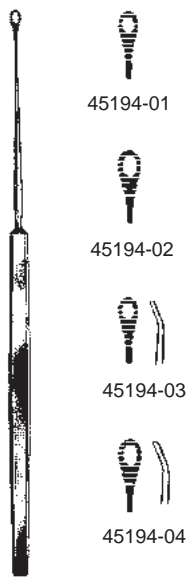

SHAPLEIGH  
 45194-01 - 45194-04  
 13 cm, 5 1/8"

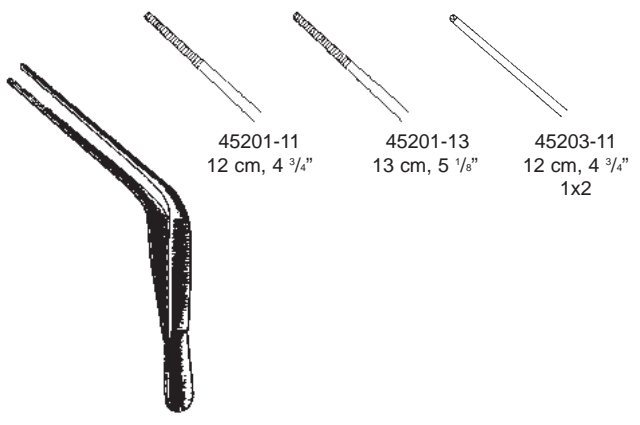

WILDE (TROELTSCH)



LUCAE  
 45206-14  
 14 cm, 5 1/2"



LUCAE  
 45206-16  
 16 cm, 6 1/4"



COTTLE  
 45208-14  
 14 cm, 5 1/2"



Polypenschnürer, Ohrzängchen  
 Snares, Ear Forceps  
 Cierra-nudos, Pinzas auriculares  
 Serranodi, Pinze auricolari



**KRAUSE**  
 45220-16  
 16 cm, 6 1/4"

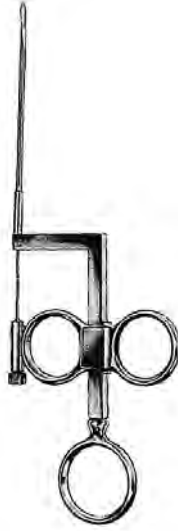

**WILDE**  
 45222-17  
 17 cm, 6 3/4"



45225-02  
 doz./doc./dozz.  
 0,2 mm

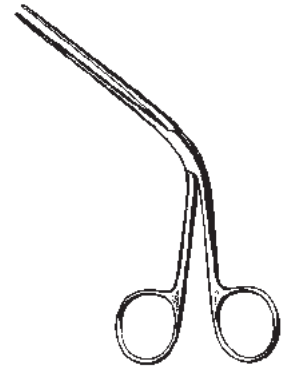

**TILLEY**  
 45243-14  
 14 cm, 5 1/2"



**LITTAUER**  
 45245-12  
 12 cm, 4 3/4"

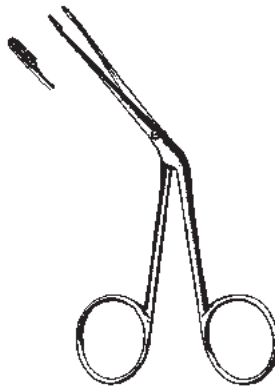

**HARTMANN**  
 45246-12  
 12 cm, 4 3/4"

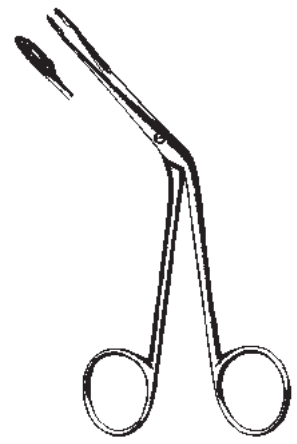

**HARTMANN**  
 45246-14  
 14 cm, 5 1/2"



# MAST.SH-GERMANY

Fremdkörperheber, Fremdkörperzängchen  
 Foreign Body Levers, Ear Polypus Forceps  
 Elevadores para cuerpos extraños, Pinzas para pólipos  
 Leve per corpi estranei, Pinze per polipi



QUIRE  
 45251-10  
 10 cm, 4"

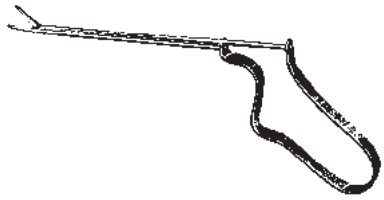

BUCK  
 45253-11  
 11 cm, 4 3/8"

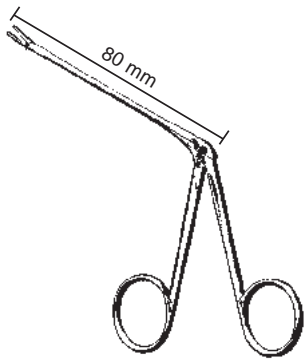

45255-08 - 45275-08



HARTMANN-WULLSTEIN  
 45255-08  
 8,5 cm, 3.4"



HARTMANN-WULLSTEIN  
 1 mm 45257-08  
 8,5 cm, 3.4"



HARTMANN  
 45261-08 8,5 cm, 3.4"  
 45261-14 14,0 cm, 5 1/2"  
 45261-16 16,0 cm, 6 1/4"



HARTMANN  
 45263-08 8,5 cm, 3.4"  
 45263-14 14,0 cm, 5 1/2"



HARTMANN  
 45265-08  
 8,5 cm, 3.4"



Ø mm HARTMANN  
 2,0 45267-20 8,5 cm, 3.4"  
 2,5 45267-25 8,5 cm, 3.4"  
 3,0 45267-30 8,5 cm, 3.4"

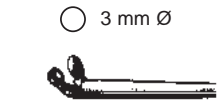

○ 3 mm Ø

HARTMANN  
 45269-30  
 8,5 cm, 3.4"



STRUEMPEL  
 45271-08 8,5 cm, 3.4"  
 2,5x5 mm



HARTMANN  
 45273-08  
 8,5 cm, 3.4"

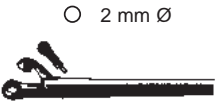

○ 2 mm Ø

HARTMANN-HOFFMANN  
 45275-08  
 8,5 cm, 3.4"



Micro-Ohrscheren, Micro-Ohrzangchen  
Micro Ear Scissors, Micro Ear Forceps  
Tijeras auriculares micro, Pinzas auriculares micro  
Forbici auricolari micro, Pinze auricolari micro

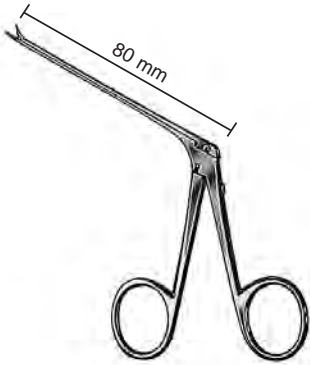

45310-40 - 45322-70



**A**  
BELLUCCI  
45310-40  
micro mini  
4 mm



**A**  
BELLUCCI  
45312-55  
micro standard  
5,5 mm



**D**  
BELLUCCI  
45313-55  
micro standard  
5,5 mm



**B**  
BELLUCCI  
45315-55  
micro standard  
5,5 mm



**C**  
BELLUCCI  
45317-55  
micro standard  
5,5 mm



**A**  
SHEA  
45320-70  
7,0 mm



**C**  
SHEA  
45321-70  
7,0 mm

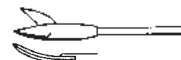

**B**  
SHEA  
45322-70  
7,0 mm

**A:** gerade / straight / recta / retta

**B:** rechts / right / derecha / destra

**C:** links / left / izquierda / sinistra

**D:** aufgebogen / curved up / curva in alto / curva hacia arriba

**E:** nach unten gebogen / curved down / curva in basso / curva hacia abajo

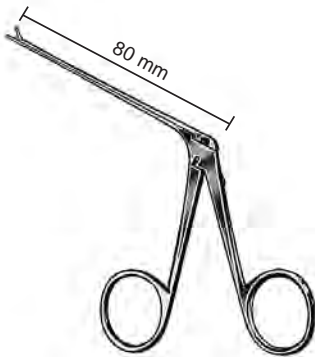

45350-40 - 45360-35



**A**  
45350-40  
4 mm



**A**  
45350-70  
7 mm



**A**  
45352-40  
4 mm



**C**  
45353-60  
6 mm



**B**  
45355-60  
6 mm



**D**  
45357-40  
4 mm



**E**  
45359-40  
4 mm



**A**  
45360-35  
3,5 mm



# MAST.SH-GERMANY

Micro-Ohrzängchen  
Micro Ear Forceps  
Pinzas auriculares micro  
Pinze auricolari micro

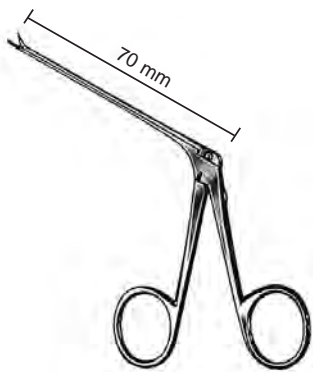

45362-45 - 45383-30

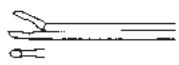

**A**  
45362-45  
4,5 mm



**C**  
45363-45  
4,5 mm



**B**  
45365-45  
4,5 mm

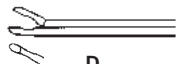

**D**  
45367-50  
5,0 mm



**E**  
45369-50  
5,0 mm



**A**  
GREVEN  
45370-50  
5,0 mm

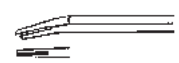

McGEE  
45371-40  
0,8x4,0 mm



COS  
45373-30  
1,8x0,8x3,0 mm

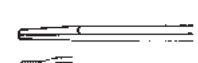

JUERS  
45375-60  
6,0 mm

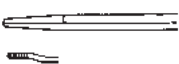

JUERS  
45377-60  
6,0 mm



**C**  
HAUGH  
45381-30  
45° 3 mm



**B**  
HAUGH  
45383-30  
45° 3 mm

**A:** gerade / straight / recta / retta  
**B:** rechts / right / derecha / destra  
**C:** links / left / izquierda / sinistra  
**D:** aufgebogen / curved up / curva in alto / curva hacia arriba  
**E:** nach unten gebogen / curved down / curva in basso / curva hacia abajo

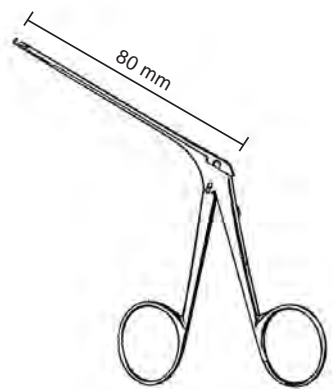

DIETER  
45385-01 - 45387-02

micro ø 1,3 mm

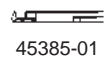

45385-01

aufwärts  
upward  
arriba  
in alto

mini ø 1,8 mm

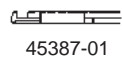

45387-01

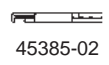

45385-02

abwärts  
downward  
abajo  
in basso

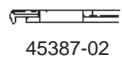

45387-02

Micro-Ohrzängchen  
 Micro Ear Forceps  
 Pinzas auriculares micro  
 Pinze auricolari micro



45390-35  
 0,8 x 3,5 mm

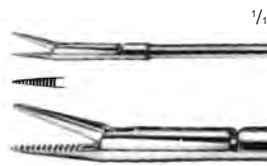

45390-50  
 1 x 5 mm



45391-35  
 0,8 x 3,5 mm

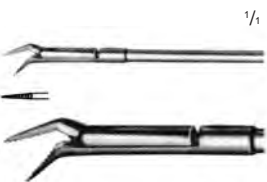

45392-35  
 0,8 x 3,5 mm



45393-50  
 1 x 5 mm



45394-50  
 1 x 5 mm

Micro-Ohrzängchen  
 Micro Ear Forceps  
 Pinzas auriculares micro  
 Pinze auricolari micro



WULLSTEIN



45400-01  
 0,9 x 1 mm



45400-02  
 0,8 x 1,3 mm



45400-03  
 1 mm



45401-25  
 1,7 x 2,5 mm



45402-10  
 0,9 x 1 mm



45403-13  
 0,8 x 1,3 mm



45404-13  
 0,8 x 1,3 mm

Micro-Ohrscheren  
 Micro Ear Scissors  
 Tijeras auriculares micro  
 Forbici auricolari micro



BELLUCCI



45410-01



45411-01



45412-01



45413-01



45414-01



# MAST.SH-GERMANY

Messer  
Knives  
Cuchillos  
Coltelli



SCHUKNECHT  
45701-01  
16 cm, 6 1/4"



SCHUKNECHT  
45701-02  
16 cm, 6 1/4"



SCHUKNECHT  
45703-15  
15,5 cm, 6"



WULLSTEIN  
45704-15  
15,5 cm, 6"



TABB  
45705-15  
15,5 cm, 6"



3,5 mm Ø

PLESTER  
45706-35  
15,5 cm, 6"

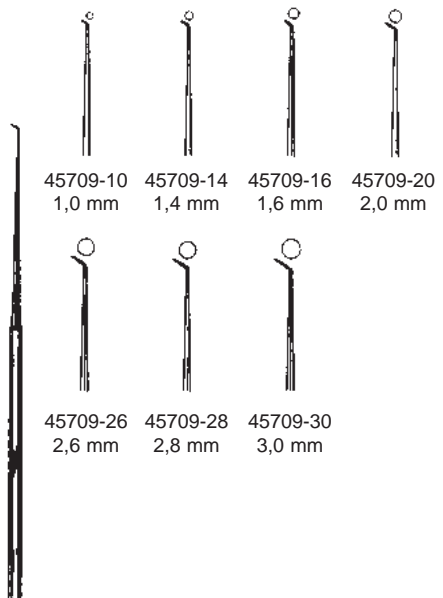

45709-10 1,0 mm  
45709-14 1,4 mm  
45709-16 1,6 mm  
45709-20 2,0 mm

45709-26 2,6 mm  
45709-28 2,8 mm  
45709-30 3,0 mm

ROSEN  
45709-10 - 45709-30  
16 cm, 6 1/4"





Nadeln und Häkchen  
Needles and Hooks  
Agujas y Ganchos  
Aghi e uncini



16 cm  
6 1/4"

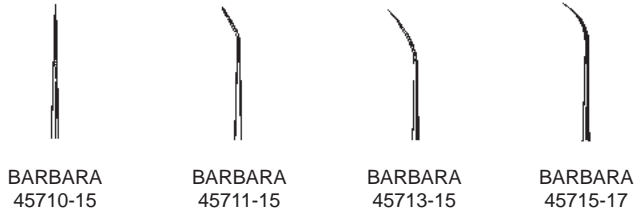

BARBARA 45710-15      BARBARA 45711-15      BARBARA 45713-15      BARBARA 45715-17



	25°	45°	90°	BARBARA
mm	SHAMBAUGH	SHAMBAUGH	SHAMBAUGH	45725-05=0,5 mm
0,3	45720-03	45722-03	45724-03	45725-10=1,0 mm
0,6	45720-06	45722-06	45724-06	
1,0	45720-10	45722-10	45724-10	
1,2		45722-12	45724-12	
1,5		45722-15	45724-15	
2,0		45722-20	45724-20	
2,5		45722-25	45724-25	



45730-03 - 45747-10  
15,5 cm, 6"

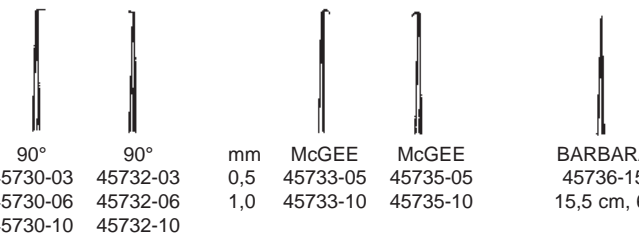

	90°	90°				
mm			mm	McGEE	McGEE	BARBARA
0,3	45730-03	45732-03	0,5	45733-05	45735-05	45736-15
0,6	45730-06	45732-06	1,0	45733-10	45735-10	15,5 cm, 6"
1,0	45730-10	45732-10				



	ROSEN					
		mm	25°	25°	45°	45°
	45737-15	0,3	45741-03	45743-03	45745-03	45747-03
	15,5 cm, 6"	0,6	45741-06	45743-06	45745-06	45747-06
		1,0	45741-10	45743-10	45745-10	45747-10



# MAST.SH-GERMANY

Dissektoren, Küretten, Elevatoren, Mikro-Meßsonde  
 Dissectors, Curettes, Elevators, Micro measuring rod  
 Disectores, Curetas, Elevadores, Sonda para mesurar  
 Dissettori, Curette, Elevatori, Sonda auricolare per misurare

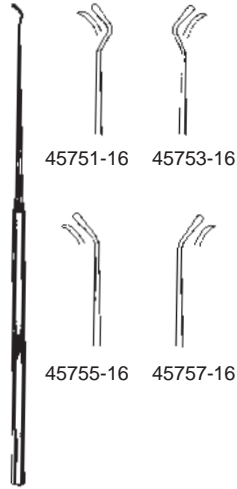

45751-16 45753-16  
 45755-16 45757-16

**FISCH**  
 45751-16 - 45757-16  
 16 cm, 6 1/4"

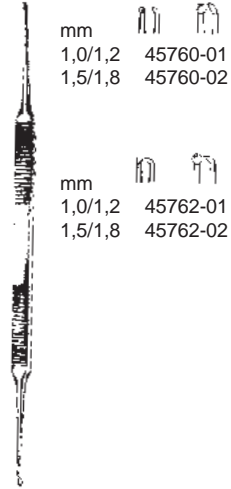

mm 1,0/1,2 45760-01  
 1,5/1,8 45760-02  
 mm 1,0/1,2 45762-01  
 1,5/1,8 45762-02

**HOUSE**  
 45760-01 - 45762-02  
 15 cm, 6"



**LEMPERT**  
 45802-16 - 45805-16  
 16 cm, 6 1/4"

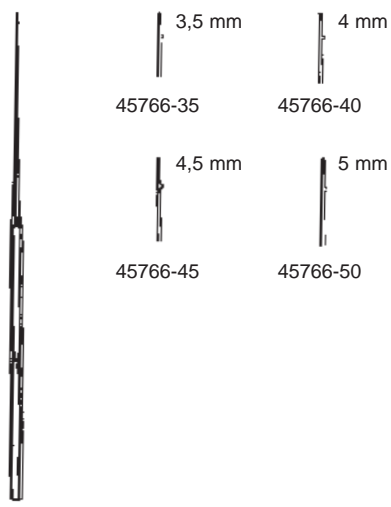

**HOUSE**  
 45766-35 - 45766-50  
 16 cm, 6 1/4"



**LEMPERT**  
 45807-20  
 20,5 cm, 8"

Nasenspekula  
 Nasal Specula  
 Espéculos nasales  
 Specoli nasali



**THUDICHUM**  
 47050-01 - 47050-07

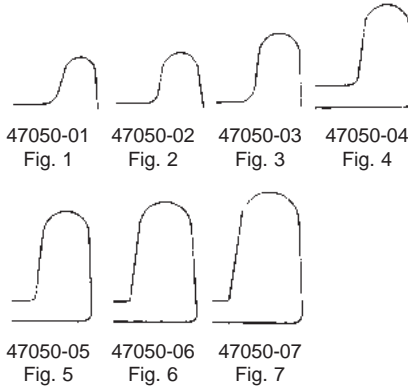

**VOLTOLINI**  
 47060-01 - 47060-03

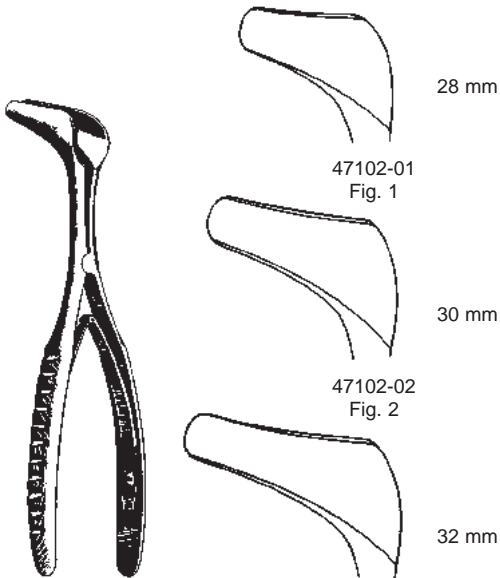

**HARTMANN-HALLE**  
 47102-01 - 47102-03  
 15 cm, 6"

Baby, bébé  
 Kind, child, niño, bamb.  
 Erwachs., Adult, adulto



**Mod. VIENNA**  
 47112-01 25 mm  
 47112-02 30 mm  
 47112-03 35 mm



**Mod. VIENNA**  
 47113-03

leichtes Modell  
 lightweight  
 mod. ligero  
 mod. leggero



# MAST.SH-GERMANY

Nasenspekula  
Nasal Specula  
Espéculos nasales  
Specoli nasali



1/4



HARTMANN



Nasenspekula, Kehlkopfspiegel  
Nasal Specula, Laryngeal Mirrors  
Especulos nasales, espejos laríngeos  
Specoli nasali, Specchi laringei



TIECK-HALLE  
47116-13  
13,5 cm, 5 1/4"



REDA  
47118-13  
12,5 cm, 5"



KILLIAN  
47120-35 - 47120-90  
13 cm, 5 1/8"



47120-35  
35 mm

47120-50  
50 mm

47120-75  
75 mm

47120-90  
90 mm



COTTLE  
47124-35 - 47124-90  
14 cm, 5 1/2"

47124-35 35 mm  
47124-50 50 mm  
47124-75 75 mm  
47124-90 90 mm

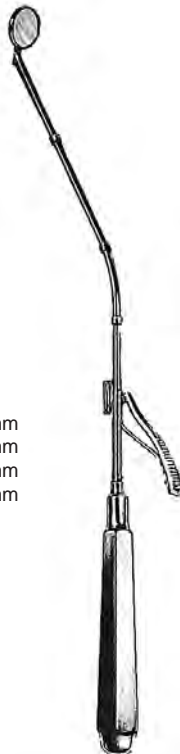

MICHEL  
47139-12 - 47139-18  
25 cm, 10"



47139-12  
12 mm



47139-14  
14 mm



47139-16  
16 mm



47139-18  
18 mm



# MAST.SH-GERMANY

Nasenpinzetten, Polypenzange  
 Ear Dressing Forceps, Ear Polypus Forceps  
 Pinzas auriculares, Pinzas para pólipos  
 Pinze auricolari, Pinze per polipi

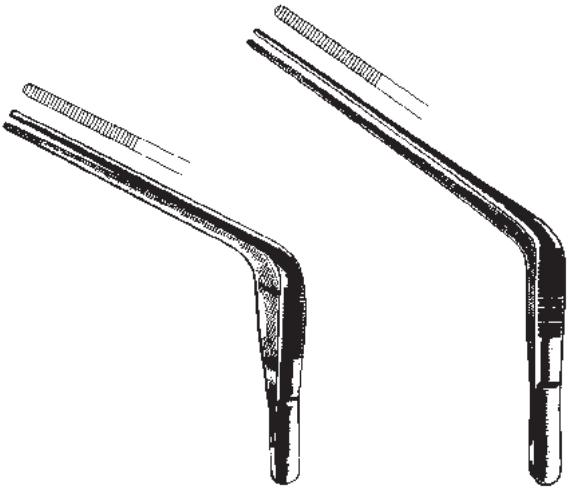

TROELTSCH  
 47151-15  
 15 cm, 6"

TROELTSCH  
 47151-18  
 18 cm, 7"



JANSEN-GRUENWALD  
 47154-20  
 20 cm, 8"



JANSEN  
 47155-20  
 20 cm, 8"

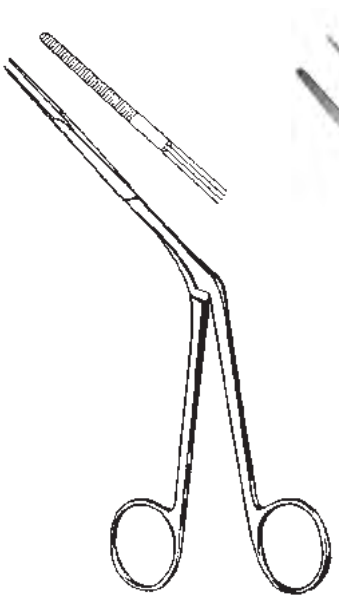

WESTMACOTT  
 47158-20  
 20 cm, 8"



LUBET-BARBON  
 47159-20  
 20 cm, 8"

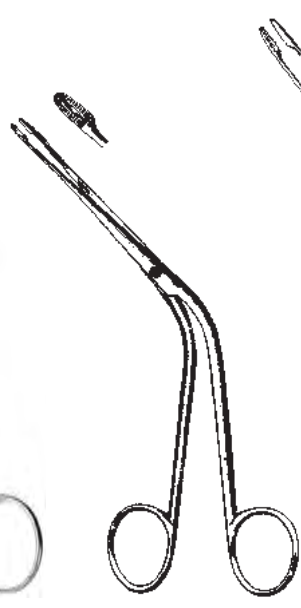

HARTMANN  
 47161-16  
 16 cm, 6 1/4"

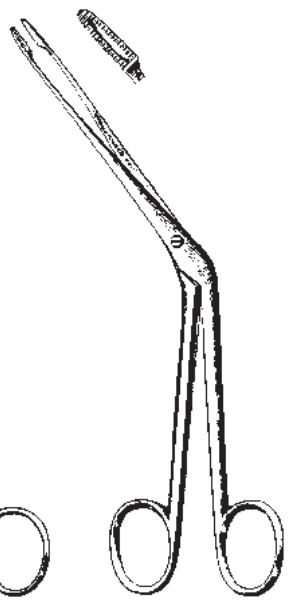

HARTMANN  
 47161-20  
 20 cm, 8"

Polypenzangen, Septumzangen  
 Nasal Polypus and Septum Forceps  
 Pinzas para pólipos y para el tabique nasal  
 Pinze per polipi, Pinze per il setto nasale

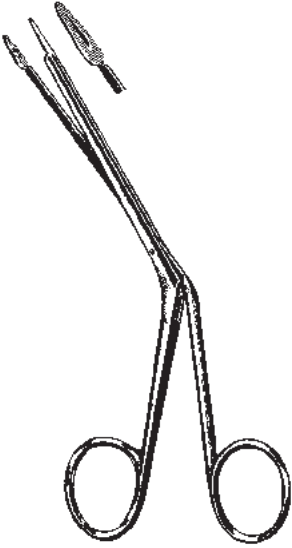

LITTAUER  
 47167-18  
 18 cm, 7"

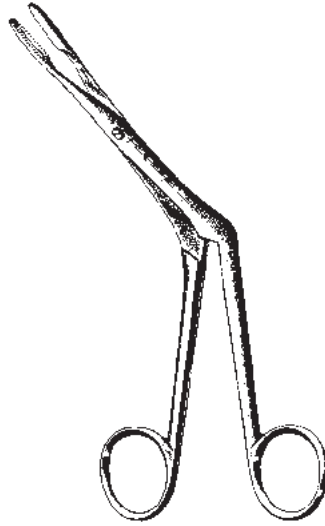

HEYMANN-KNIGHT  
 47169-18  
 18 cm, 7"

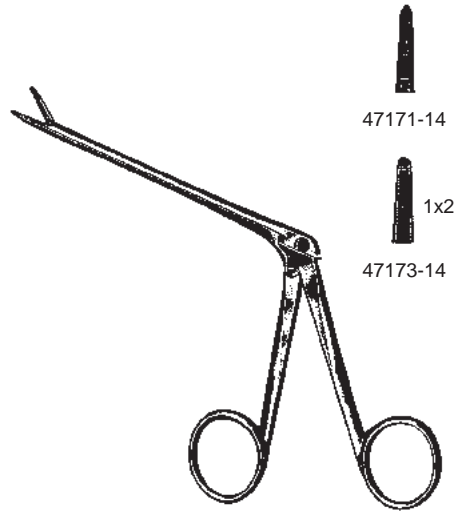

NOYES  
 47171-14 - 47173-14  
 14,5 cm, 5 3/4"

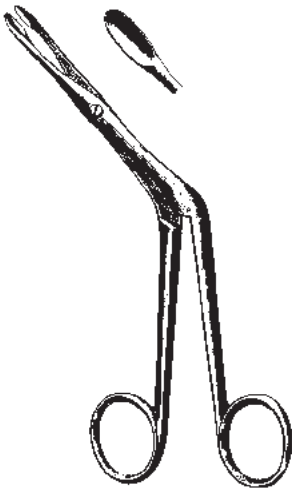

HEYMANN  
 47181-18  
 18 cm, 7"

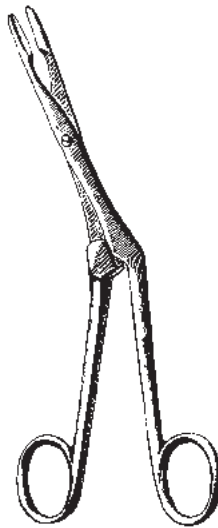

KNIGHT  
 47185-18  
 18 cm, 7"

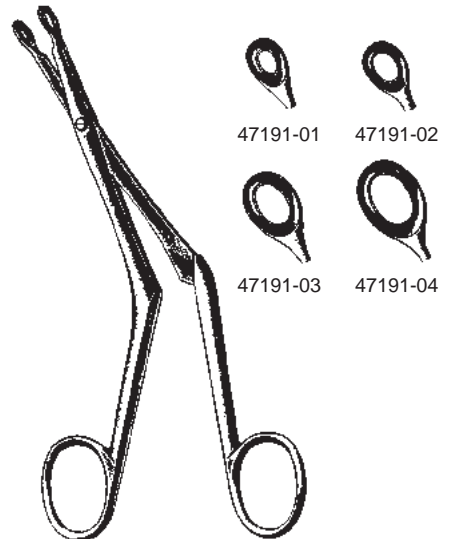

BRUENINGS  
 47191-01 - 47191-04  
 19 cm, 7 1/2"



# MAST.SH-GERMANY

Scharfe Nasenzangen, Septumzangen  
 Nasal Cutting Forceps, Septum Forceps  
 Pinzas cortantes nasales y para el tabique nasal  
 Pinze taglienti nasali, Pinze per il setto nasale



GRAIG  
 47192-16  
 16 cm, 6 1/4"

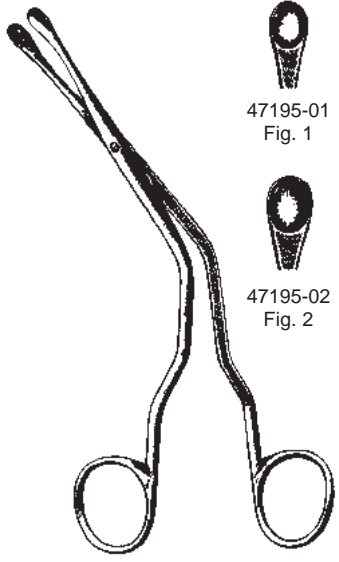

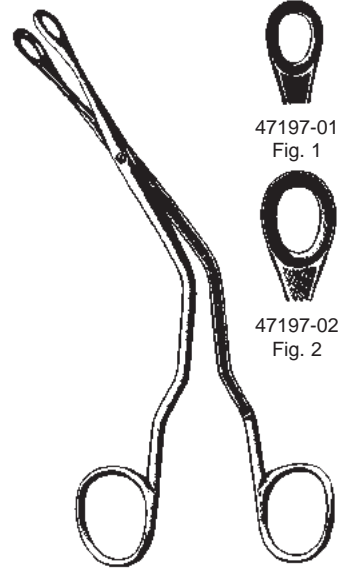

LUC  
 47195-01 - 47195-05  
 19 cm, 7 1/2"



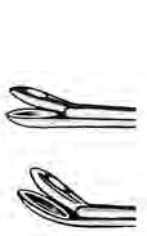

LUC  
 47197-01 - 47197-02  
 19 cm, 7 1/2"



	
Fig. 1 47223-01	Fig. 2 47223-02
3,0 mm	3,6 mm
47224-01	47224-02



		
Fig. 3 47223-03	Fig. 4 47223-04	Fig. 5 47223-05
4,2 mm	4,8 mm	5,8 mm
47224-03	47224-04	47224-05

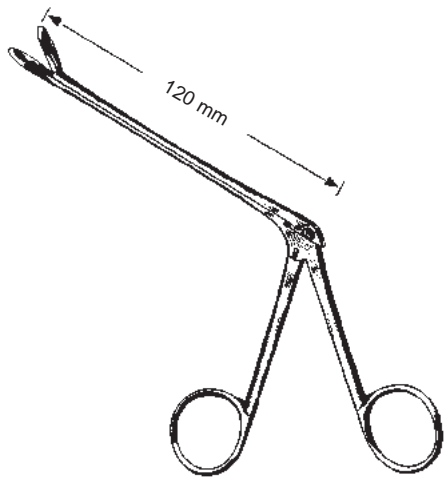

WEIL-BLAKESLEY  
 47223-01 - 47224-05





**MAST.SH-GERMANY**

Scharfe Nasenzangen  
Nasal Cutting Forceps  
Pinzas cortantes nasales  
Pinze taglianti nasali

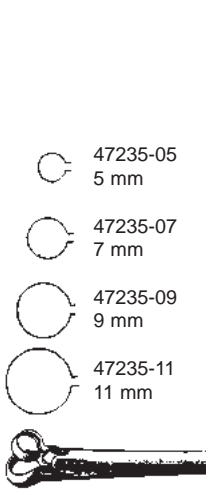

HARTMANN

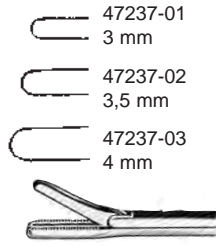

MYLES

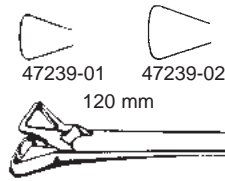

SCHMEDEN

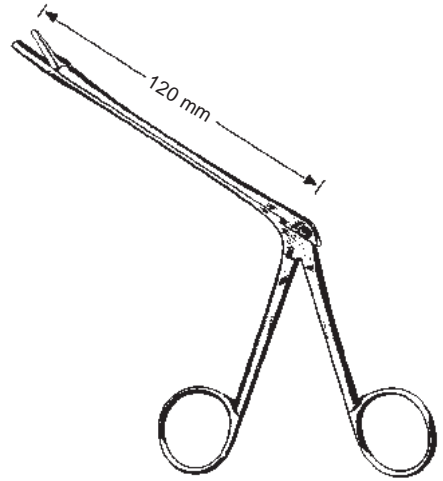

STRUYCKEN  
47240-19



47242-00

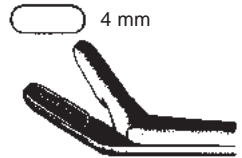

47242-01

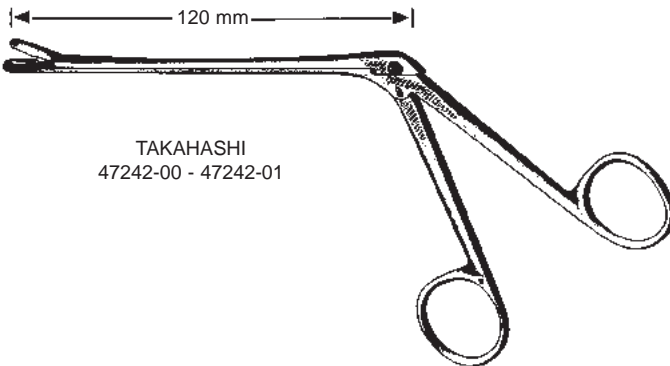

TAKAHASHI  
47242-00 - 47242-01



# MAST.SH-GERMANY

Scharfe Nasenzangen, Septumzange, Kieferhöhlenstanze  
 Nasal Cutting Forceps, Septum Forceps, Antrum Punch Forceps  
 Pinzas cortantes nasales, Pinza para magullar tabique, Pinzas cortantes para maxilares  
 Pinze taglianti nasali, Pinza per ammaccare il setto, Pinze taglianti per seno mascellare



RUBIN  
 47251-21  
 21 cm, 8 1/4"

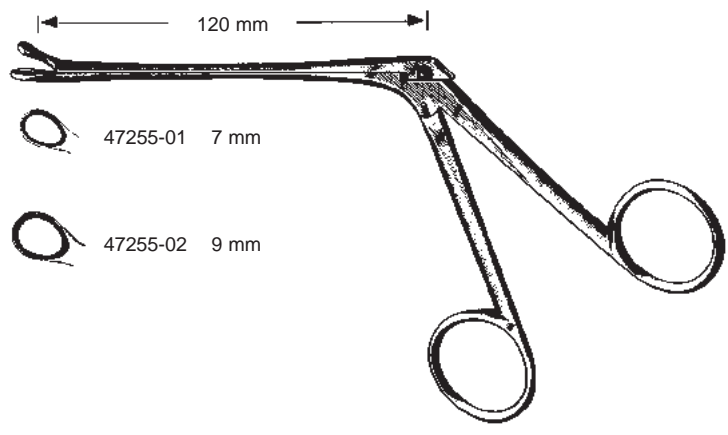

WATSON-WILLIAMS  
 47255-01



CAPLAN  
 47256-20  
 20 cm, 8"



KERRISON  
 3x3 mm 47303-03  
 4x4 mm 47303-04  
 5x5 mm 47303-05  
 6x6 mm 47303-06  
 17 cm, 6 3/4"

Kieferhöhlenstanze, Nasenschere  
 Antrum Punch Forceps, nasal scissors  
 Pinzas cortantes para maxilares, tijera nasal  
 Pinze sfenoidali, forbici nasali



47304-01 5x3,5 mm

47304-03 5x4 mm



47304-02 5x3,5 mm

47304-04 5x4 mm

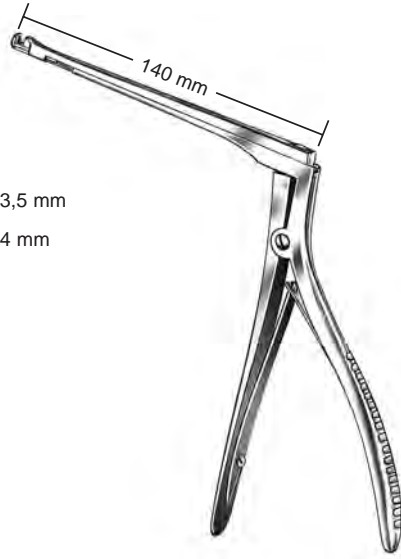

HAJEK-KOFLER  
 47304-01 - 47304-04

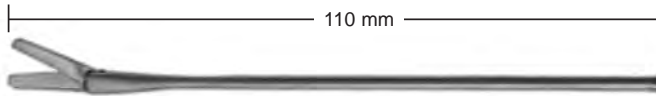

47305-02  
 rechts gebogen  
 right curved  
 curva a la derecha  
 curva a destra



47305-03  
 links gebogen  
 left curved  
 curva a la izquierda  
 curva a sinistra



47305-01  
 gerade  
 straight  
 recta  
 retta



# MAST.SH-GERMANY

Knochenstanze, Septumzangen  
 Punches, Septum Forceps  
 Pinzas osteótomos, Pinzas para el tabique nasal  
 Pinze osteotomi, Pinze per il setto nasale

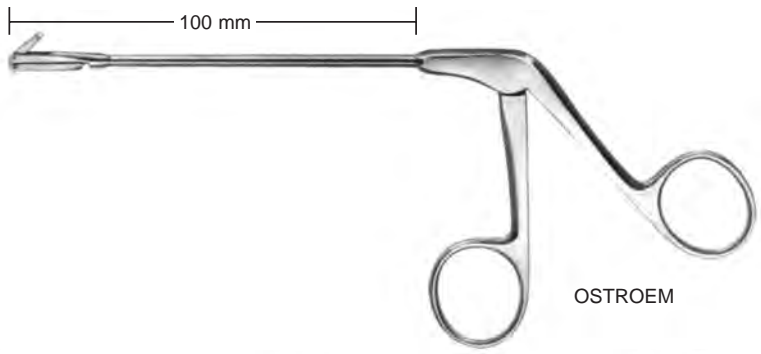

OSTROEM



47315-00  
 2 mm  
 oben schneidend  
 up cutting  
 cortante por arriba  
 tagliente in alto



47316-00  
 2 mm  
 rechts schneidend  
 right cutting  
 cortante a la derecha  
 tagliente a destra



47317-00  
 2 mm  
 links schneidend  
 left cutting  
 cortante a la izquierda  
 tagliente a sinistra



CITELLI  
 47311-10 1,0 mm  
 47311-25 2,5 mm  
 47311-30 3,0 mm

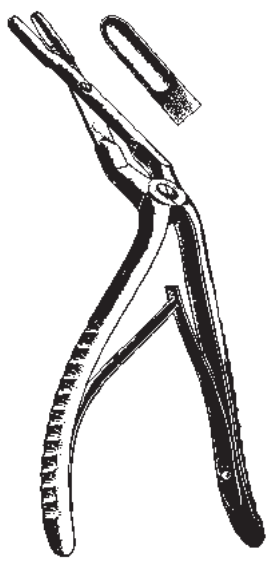

MIDDLETON-JANSEN  
 47323-19  
 19 cm, 7 1/2"

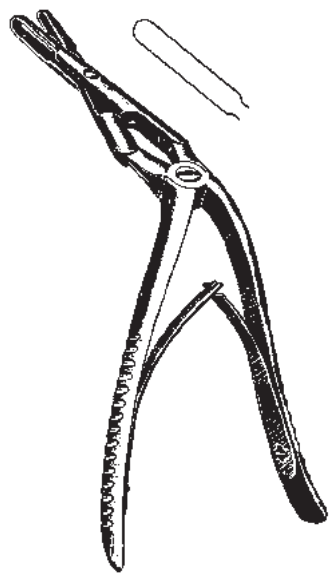

MIDDLETON-JANSEN  
 47325-19  
 19 cm, 7 1/2"



Kieferhöhlenstanze, Sinuskopie-Zangen  
 Antrum Punch Forceps, Sinuscopy forceps  
 Pinzas cortantes para maxilares, Pinzas para sinuscopia  
 Pinze sfenoidali per seno mascellare, Pinze per sinuscopia



HAJEK-KOFLER  
 47316-16  
 3,5 mm

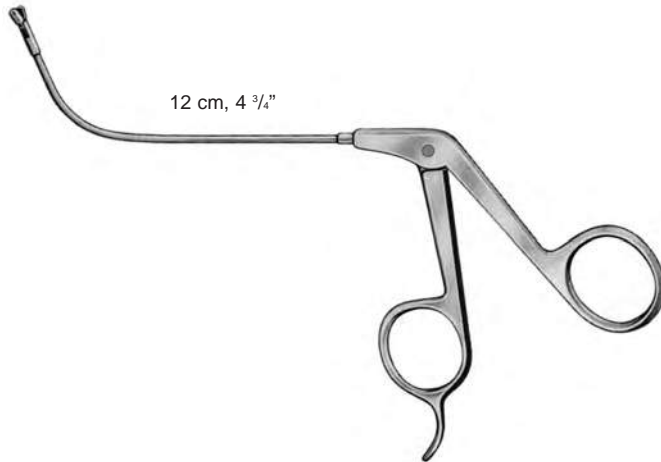

Maul jaw boca morso		horizontal öffnend horizontal cutting abierta horizontal apertura orizzontale	vertikal öffnend vertical cutting abierta vertical apertura verticale
65°	○ 3 mm rund	47317-65	47318-65
70°	◌	47317-70	47318-70
90°	◌ } oval	47317-90	47318-90
110°	◌ }	47317-11	47318-11



# MAST.SH-GERMANY

Zirkular Stanze  
Circular Forceps  
Pinza circular  
Pinza circolare



47319-35 3,5 mm  
47319-45 4,5 mm

Spülkanülen, Punktionskanüle, Stirnhöhlerdilator  
 cannulas, Antrum trocar needle, Frontal sinus bougies  
 cánulas, cánula de punción, Dilatador para el seno  
 cannulas, cannula per punzione, Dilatatore per seno frontale

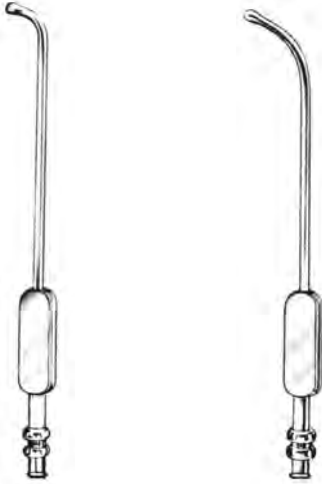

**EICKEN (KILLIAN)**  
 14,5 cm, 5 3/4"

	Ø	
47331-20	2,0 mm	47332-20
47331-25	2,5 mm	47332-25
47331-30	3,0 mm	47332-30
47331-40	4,0 mm	47332-40

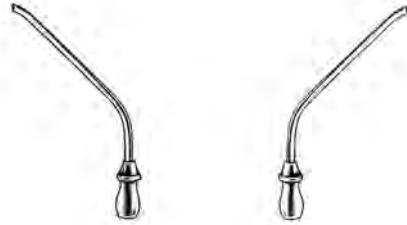

**HARTMANN**

Fig. 1	Ø	Fig. 2
47338-20	2,0 mm	47339-20
47338-25	2,5 mm	47339-25
47338-30	3,0 mm	47339-30





Ø mm **LICHTWITZ**  
 1,5 47340-15  
 1,8 47340-18  
 2,0 47340-20  
 Luer-Lock  
 10 cm, 4"



Ø mm **RITTER-HALLE**  
 2,5 47342-25  
 3,0 47342-30  
 4,0 47342-40

Kiefer- und Stirnhöhlen-Spülkanülen, Saugraspatorium  
 Antrum and Frontal Sinus Wash Cannulas, Suction Raspatory  
 Cànulas lavadoras para seno maxilar y seno frontal, Legra de succión  
 Cannule per seno mascellare e seno frontale, Raspatorio con aspiratore

- 
- Ø mm  
 1,5 47343-15  
 1,7 47343-17  
 2,0 47343-20  
 2,5 47343-25  
 3,0 47343-30

- 
- Ø mm  
 1,5 47344-15  
 1,7 47344-17  
 2,0 47344-20  
 2,5 47344-25  
 3,0 47344-30



SIEBENMANN  
47343-15 - 47344-30



KILLIAN  
Ø 1,5 mm  
47345-15



GUILLEN  
19 cm, 7 1/2"  
47347-20



Polypenschnürer  
 Ear Polypus Snares  
 Polipótomos  
 Serranodi



KRAUSE-VOSS  
 47350-26  
 26 cm, 10 1/4"



KRAUSE  
 47351-26  
 26 cm, 10 1/4"



WILDE  
 47352-24  
 24 cm, 9 1/2"



47355-03 0,3 mm

Nasenmesser  
 Nasal Knives  
 Bisturies nasales  
 Coltelli nasali

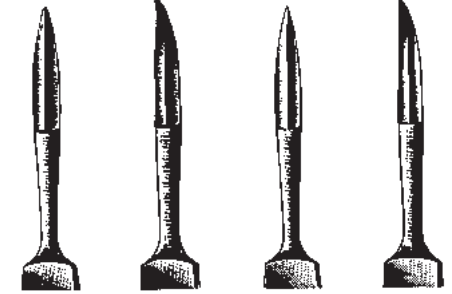

47370-16 47371-16  
 stumpf, blunt,  
 romos, smussi

47372-16 47373-16  
 spitz, pointed,  
 agudos, acuti

JOSEPH  
 47370-16 - 47373-16  
 16 cm, 6 1/4"



FREER  
 47374-16  
 16,5 cm, 8 1/4"



FREER  
 47375-19  
 19 cm, 7 1/2"



JOSEPH  
 47375-16  
 16,5 cm, 6 1/2"



Nasenplastik- und Operationsmesser, Sichelmesser, Küretten  
Rhinoplastic and Nasal Knives, Septum Sickle Knives, Curettes  
Bisturios para plastica y operaciones de la nariz, Bisturios para el tabique nasal, Curetas  
Bisturi per la plastica ed operazioni nasali, coltelli per setto, Curette



JOSEPH  
47376-16  
16 cm, 6 1/4"



CONVERSE  
47379-16  
16 cm, 6 1/4"



COTTLE  
47380-15  
15 cm, 6"



COTTLE  
47382-15  
15 cm, 6"



JOSEPH  
47384-15  
15 cm, 6"



JOSEPH  
47385-15  
15 cm, 6"



REDA  
19 cm, 7 1/2"



47386-01  
spitz  
pointed  
agudo  
acuto



47386-02  
stumpf  
blunt  
romo  
smusso



ANTRUM  
19 cm, 7 1/2"



47387-01  
vorwärts schneidend  
forward cutting  
corte hacia adelante  
taglio in avanti



47387-02  
rückwärts schneidend  
backward cutting  
corte hacia atras  
taglio retrograde



# MAST.SH-GERMANY

Schwingmesser  
Septum Swivel Knives  
Bisturies para el tabique nasal  
Coltelli per setto



47390-03  
3 mm



47390-04  
4 mm



47390-05  
5 mm



47392-03  
3 mm



47392-04  
4 mm



47392-05  
5 mm

BALLENGER  
47390-03 - 47392-05  
20 cm, 8"

Septum Elevatoren  
 Septum Elevators  
 Elevadores para el tabique  
 Elevatori per setto



McKENTY  
 47410-04 - 47410-05  
 15 cm, 6"

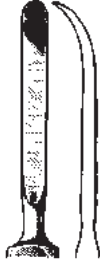

47410-04  
 4 mm

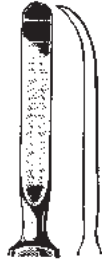

47410-05  
 5 mm



HALLE  
 47410-16  
 16.5 cm, 6 1/2"



JOSEPH  
 47411-16  
 16 cm, 6 1/4"



ROGER  
 47413-19  
 19 cm, 7 1/2"



FREER  
 47415-18  
 18 cm, 7"

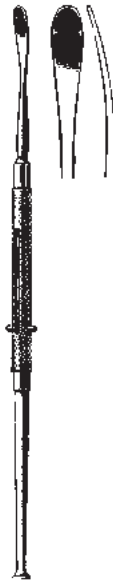

FREER  
 47417-19  
 19 cm, 7 1/2"

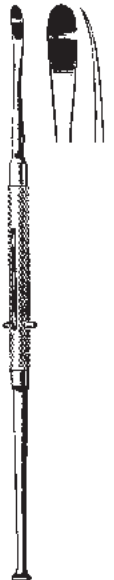

FREER  
 47419-19  
 19 cm, 7 1/2"

Septum Elevatoren  
 Septum Elevators  
 Elevadores para el tabique  
 Elevatori per setto



KILLIAN  
 47420-01  
 18,5 cm, 7 1/4"



PIERCE  
 47420-02  
 21 cm, 8 1/4"



SINUS  
 47420-03  
 18 cm, 7"



PENNINGTON  
 47420-04  
 21 cm, 8 1/4"



McKENTY  
 47420-20  
 22 cm, 8 3/4"



HOWARTH  
 47421-21  
 21,5 cm, 8 1/2"

Septum Elevatoren  
 Septum Elevators  
 Elevadores para el tabique  
 Elevatori per setto

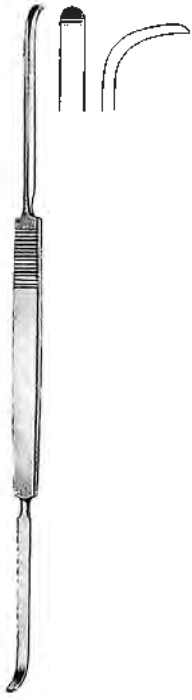

**COTTLE**  
 47421-23  
 23 cm, 9"



**COTTLE JOSEPH**  
 47422-22  
 22 cm, 8 3/4"



**COTTLE**  
 47423-22  
 22 cm, 8 3/4"



**COTTLE**  
 47424-16  
 16 cm, 6 1/4"



**COTTLE**  
 47425-19  
 19 cm, 7 1/2"



**KILLIAN**  
 47426-22  
 22 cm, 8 3/4"



**HAJEK-BALLENGER**  
 47428-21  
 22 cm, 8 3/4"



**BALLENGER**  
 47430-22  
 22 cm, 8 3/4"



**FREER**  
 47450-04  
 15 cm, 6"



**FREER**  
 47451-04  
 15 cm, 6"

Septum Meißel, Knorpelquetscher  
 Rhinoplastic Chisels, Cartilage crusher  
 Cinceles para la plástica nasal, Macha cadera  
 Scalpelli per plastica nasale, Tritacartilagine

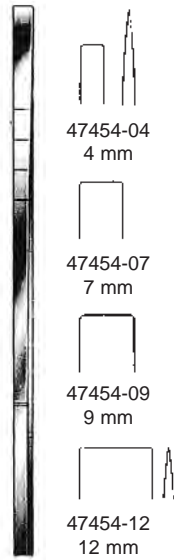

COTTLE  
 47454-04 - 47454-12  
 18 cm, 7"



COTTLE  
 47455-06  
 18 cm, 7"

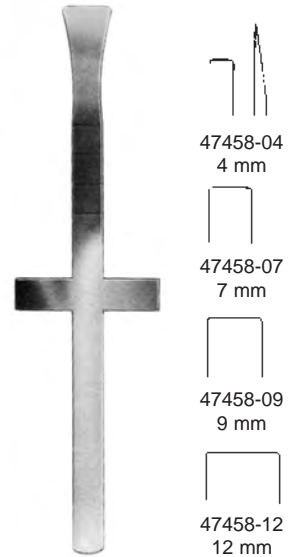

COTTLE  
 47458-04 - 47458-12  
 18 cm, 7"

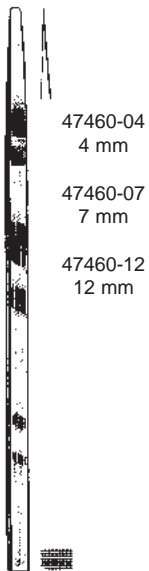

COTTLE  
 47460-04 - 47460-12  
 18 cm, 7"



COTTLE  
 Knorpelquetscher  
 47461-00

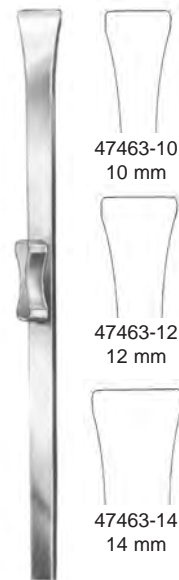

RUBIN  
 18,5 cm, 7 1/4"





Septum Meißel  
Rhinoplastic Chisels  
Cinceles para la plàstica nasal  
Scalpelli per plastica nasale



FOMON  
47470-04 - 47470-07  
17 cm, 6 3/4"

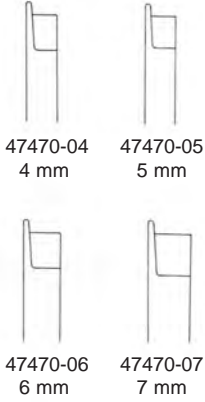

SHEEHAN  
47471-07 - 47471-12  
16 cm, 6 3/4"

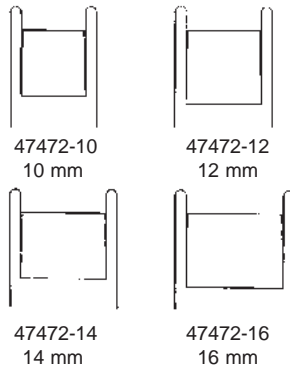
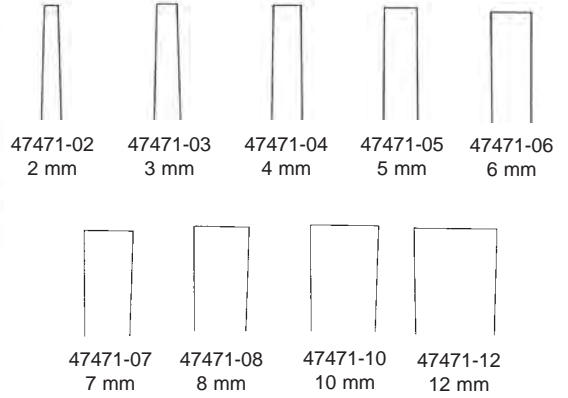

CINELLI  
47472-10 - 47472-16  
16 cm, 6 1/4"



# MAST.SH-GERMANY

Osteotom, Septum Meißel  
 Osteotomes, Rhinoplastic Chisels  
 Osteotomi, Cinceles para la plástica nasal  
 Osteotomi, Scalpelli per plastica nasale

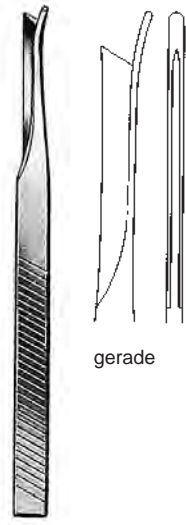

gerade

SILVER  
 47473-01  
 18 cm, 7"

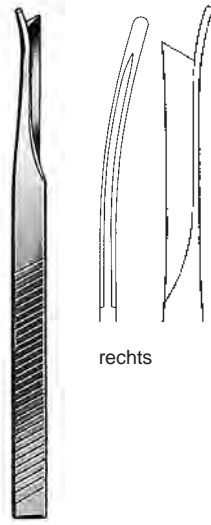

rechts

SILVER  
 47473-02  
 18 cm, 7"

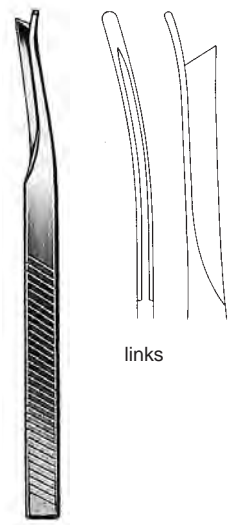

links

SILVER  
 47473-03  
 18 cm, 7"

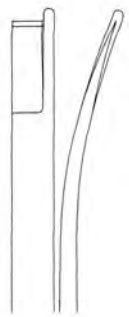

47474-01  
7 mm

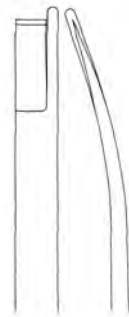

47474-02  
7 mm

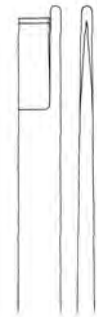

47474-03  
7 mm

NEIVERT-ANDERSON  
 47474-01 - 47474-03  
 20,5 cm, 8"

Septum Meißel  
 Rhinoplastic Chisels  
 Cinceles para la plástica nasal  
 Scalpelli per plastica nasale



**KILLIAN**  
 47481-05  
 16 cm, 6 1/4"



**KILLIAN-CLAUS**  
 47482-05  
 17 cm, 6 3/4"



mm	<b>HAJEK</b>
4	47484-04
6	47484-06
8	47484-08
	16 cm, 6 1/4"



**WEST**  
 47486-16  
 16 cm, 6 1/4"



**WEST**  
 47487-16  
 16 cm, 6 1/4"

6 mm



**FREER**  
 47489-16  
 16 cm, 6 1/4"



Nasenraspeln  
Nasal Rasps  
Escofinas nasales  
Raspa nasale

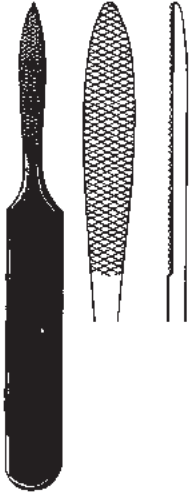

JOSEPH  
47502-16  
16 cm, 6 1/4"

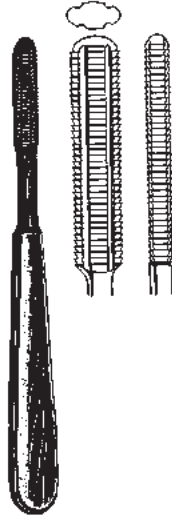

MALTZ  
47504-18  
18 cm, 7"



WIENER  
47507-17 - 47507-19  
18 cm, 7"

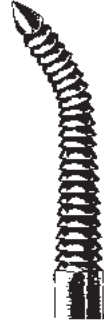

47507-17



47507-19

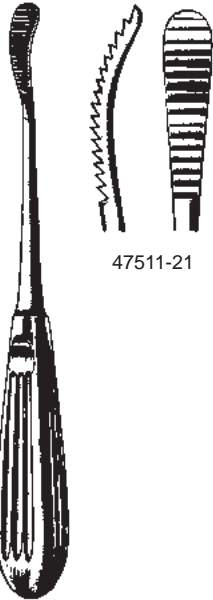

47511-21

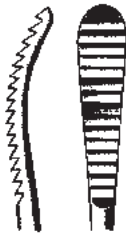

47513-21



47514-16  
fein, fino  
fine, fina



47516-16  
grob, coarse,  
gruesa, grossa



JOSEPH(Lewis)  
47514-16 - 47516-16  
18 cm, 7"

AUFRICHT  
47511-21 - 47513-21  
21 cm, 8 1/4"

Nasenraspeln  
 Nasal Rasps  
 Escofinas nasales  
 Raspa nasale

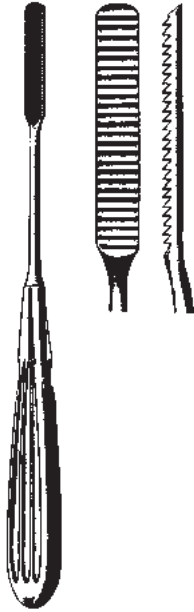

MALTZ (COTTLE)  
 47518-21  
 21 cm, 8 1/4"

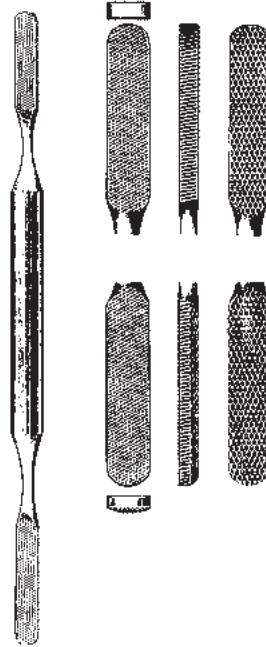

FOMON  
 47520-21  
 21 cm, 8 1/4"

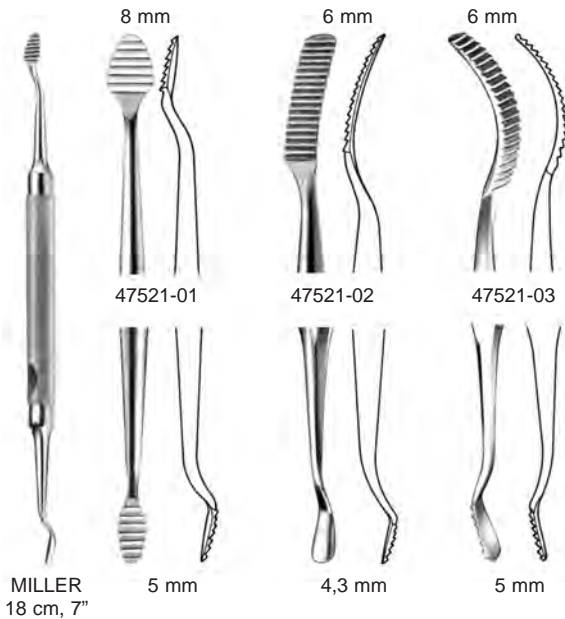

Nasenraspeln  
 Nasal Rasps  
 Escofinas nasales  
 Raspa nasale

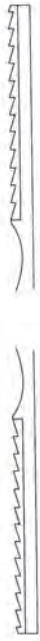

Fig. 1/2



Fig. 3/4



Fig. 5/6



Fig. 7/8



Fig. 9/10

**47522-01 - 47522-09 TC**  
 20 cm, 8"

**47522-01 TC**

**47522-04 TC**

**47522-05 TC**

**47522-07 TC**

**47522-09 TC**

Nasenraspeln, Nasensägen  
 Nasal Rasps, Nasal Saws  
 Escofinas nasales, Sierras nasales  
 Raspa nasale, Seghe nasale



PEET  
 47523-01 —  
 47523-02 —  
 19 cm, 7 1/2"



GALLAHER  
 47526-16 - 47529-16  
 16 cm, 6 1/4"



Fig. 1  
 47526-16



Fig. 2  
 47527-16



Fig. 3  
 47529-16



JOSEPH  
 47535-01 47535-02  
 17 cm, 6 3/4"

gerade  
 straight  
 redo  
 retta



links  
 left  
 izquierda  
 a sinistra



rechts  
 right  
 derecha  
 a destra

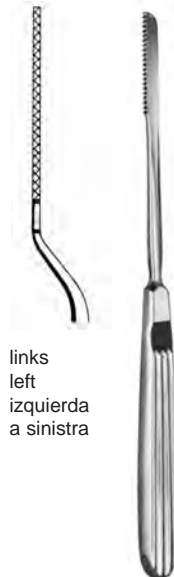

47532-19  
 JOSEPH  
 19 cm (7 1/2")  
 47533-19  
 47534-19

Nasenhaken  
 Nasal retractor  
 Retractores nasales  
 Retrattori nasali



COTTLE  
 47540-16  
 16 cm, 6 1/4"



MASING  
 47541-14  
 14 cm, 5 1/2"



AUFRICHT  
 47542-12  
 12 cm, 4 3/4"



AUFRICHT  
 47551-16  
 16 cm, 6 1/4"



AUFRICHT  
 47551-16L  
 16 cm, 6 1/4"



MASING-NEIVERT  
 47552-16 16 cm, 6 1/4"



Nasenhaken, Hauthäkchen  
 Nasal retractor  
 Retractores nasales, Ganchos para la piel  
 Retrattori nasali, uncini nasali

10 x 12 mm



**COTTLE**  
 47553-15  
 15 cm, 6"



47554-01

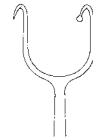

47554-02



47554-03

**COTTLE**  
 14,5 cm, 5 3/4"

3 x 11 mm



**KILNER**  
 47555-08  
 8 cm, 3 1/8"



**FOMON**  
 47556-16  
 16 cm, 6 1/4"



**FOMON**  
 47557-17  
 17 cm, 6 3/4"



# MAST.SH-GERMANY

Hauthäkchen, Columella Pinzette  
Retractor, Columnella forceps  
Ganchos para la piel, Pinza para columnela  
Uncini, Pinzetta columella



FREER  
47558-15  
15 cm, 6"

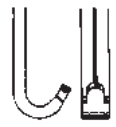

COTTLE-NEIVERT  
47559-20  
20 cm, 8"



Fig.  
1  
2



Fig. 1



Fig. 2

GILLIES  
47560-18  
47562-18  
18 cm, 7"



LANGE  
47563-22  
23 cm, 9"



COTTLE  
47564-16  
16 cm, 6 1/4"



COTTLE  
47565-10  
10 cm, 4"



CONVERSE  
47566-12  
12 cm, 4 3/4"

Septumrichtzangen, Küretten  
 Septum Straightening Forceps, Curettes  
 Pinza para enderezar el tabique nasal, curetas  
 Pinza per la plastica nasale, Curette



ASCH  
 47571-23  
 23 cm, 9"



WALSHAM  
 47572-23 - 47575-23  
 23 cm, 9"



47572-23  
 gerade  
 straight  
 recta  
 retta

47573-23  
 links  
 left  
 izquierda  
 a sinistra

47575-23  
 rechts  
 right  
 derecha  
 a destra



FAULKNER  
 47601-21  
 21 cm, 8 1/4"



47607-01  
 Fig. 1

47607-02  
 Fig. 2

47607-03  
 Fig. 3

47607-04  
 Fig. 4

47607-05  
 Fig. 5

47607-06  
 Fig. 6

COAKLEY  
 47607-01 - 47607-06  
 17 cm, 6 3/4"



# MAST.SH-GERMANY

Ringmesser, Innendurchmesser  
 Adenoid Curettes, inner diameter  
 Cuchillos para vegetaciones adenoides, camera diámetro  
 Coltelli per vegetazioni adenoidi, interno diametro

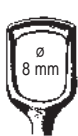

47620-00  
Fig. 0

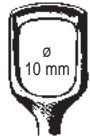

47620-01  
Fig. 1

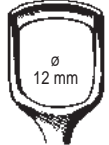

47620-02  
Fig. 2

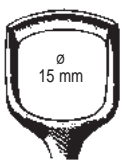

47620-03  
Fig. 3

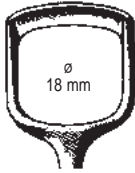

47620-04  
Fig. 4

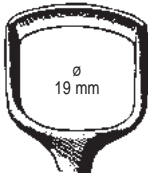

47620-05  
Fig. 5

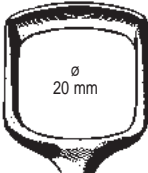

47620-06  
Fig. 6

BECKMANN  
47620-01 - 47620-06  
22 cm, 8 3/4"



47636-01  
Fig. 1



47636-02  
Fig. 2

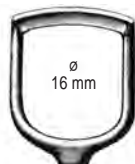

47636-03  
Fig. 3



47636-04  
Fig. 4

St. CLAIR-THOMSON  
47636-01 - 47636-04  
21 cm, 8 1/4"

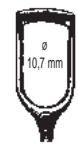

47630-00  
Fig. 0



47630-01  
Fig. 1

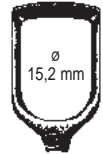

47630-02  
Fig. 2

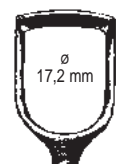

47630-03  
Fig. 3

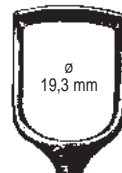

47630-04  
Fig. 4

BARNHILL  
47630-01 - 47630-04  
21 cm, 8 1/4"



47641-01  
Fig. 1  
ø 12 mm



47641-02  
Fig. 2  
ø 16 mm



47641-03  
Fig. 3  
ø 18 mm

Ersatzklingen allein, gelocht  
 Spare blades, perforated  
 Hojas de repuesto, perforadas  
 Lame di ricambio, forate

Fig. 1 47642-01  
 Fig. 2 47642-02  
 Fig. 3 47642-03

LAFORCE  
47641-01 - 47641-03  
25 cm, 10"

Zungenspatel, Wangen- und Lippenhalter  
 Tongue Depressors, Cheek and Lip Retractors  
 Baja-lenguas, Separadores para labios y mejillas  
 Abbassalingua, Divaricatori per guance e labbra

Holz  
 wood  
 madera  
 legno



49102-16  
 16 cm, 6 1/4"  
 Pack. à 100



MAYO  
 49103-17  
 17 cm, 6 3/4"



KROENIG  
 49104-15  
 15 cm, 6"



FRENZEL  
 49105-16  
 16,5 cm, 6 1/2"



49106-01  
 14,5 cm, 5 3/4"



49106-02  
 14,5 cm, 5 3/4"



BRUENINGS  
 49107-19  
 19 cm, 7 1/2"



CAWOOD-MINNESOTA  
 49108-15  
 15 cm, 6"

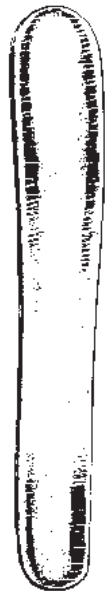

BUCHWALD  
 49109-19  
 19 cm, 7 1/2"

Zungendrucker  
 Tongue Depressors  
 Baja-lenguas  
 Abassalingua



MORITZ-SCHMIDT  
 49110-19  
 19 cm, 7 1/2"



HARTMANN  
 49111-15  
 15 cm, 6"



49115-01  
 Fig. 1  
 14 cm, 5 1/2"



49115-02  
 Fig. 2  
 15 cm, 6"

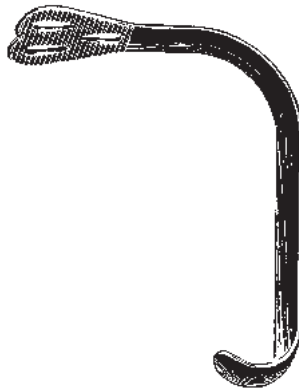

WIEDER  
 49115-01 - 49115-02

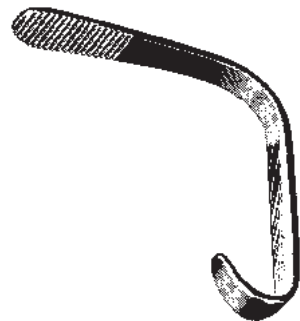

ANDREW  
 49117-11  
 11 cm, 4 3/8"

Zungendrucker, Wangen- und Lippenhalter, Zungenzangen  
 Tongue Depressor, Cheek and Lip Retractor, Tongue Holding Forceps  
 Baja-lenguas, Separadores para labios y mejillas, Pinza tira-lenguas  
 Abassalingua, Divaricatori per guance e labbra, Pinza tirilingua

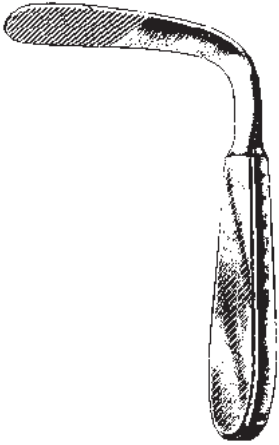

**TOBOLD**  
 49119-14  
 14,5 cm, 5 3/4"



49230-11  
 11 cm, 4 3/8"



**STERNBERG**  
 49231-12 12 cm, 4 3/4"  
 49231-14 14 cm, 5 1/2"  
 49231-16 16 cm, 6 1/4"



49235-19  
 19 cm, 7 1/2"

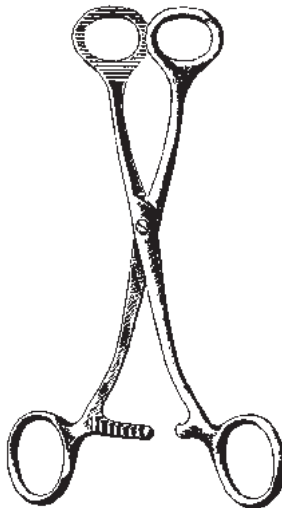

**COLLIN**  
 49250-16 16 cm, 6 1/4"  
 49250-18 18 cm, 7"

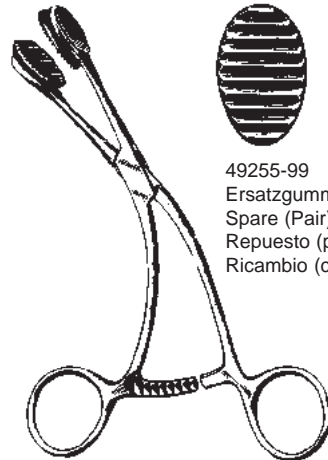

**YOUNG**  
 49255-16  
 16 cm, 6 1/4"



49255-99  
 Ersatzgummibacken (Paar)  
 Spare (Pair)  
 Repuesto (pareja)  
 Ricambio (coppia)

Mundsperrer  
 Mouth Gags  
 Abre-Bocas  
 Apribocca



DOYEN-JANSEN (MOLT)  
 49265-12  
 12 cm, 4 3/4"

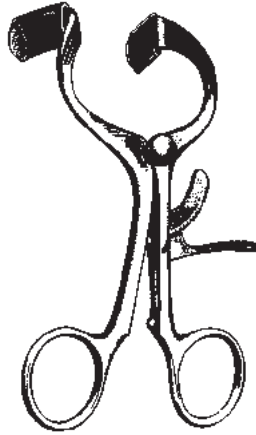

DOYEN-JANSEN (MOLT)  
 49265-14  
 14 cm, 5 1/2"

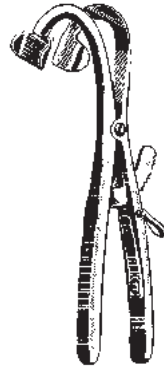

DENHART  
 49267-12  
 12 cm, 4 3/4"

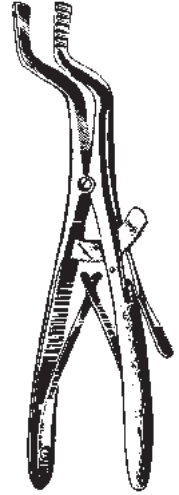

ROSER-KOENIG  
 49270-16 16 cm, 6 1/4"  
 49270-19 19 cm, 7 1/2"

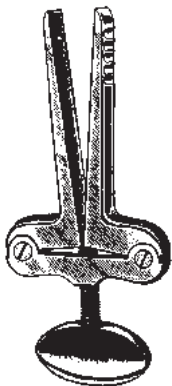

HEISTER  
 49272-13  
 13 cm, 5 1/8"

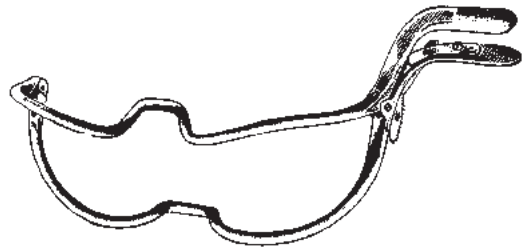

JENNINGS  
 49274-09 9 cm, 3 1/2"  
 49274-11 11 cm, 4 3/8"  
 49274-13 13 cm, 5 1/8"  
 49274-15 15 cm, 6"



Zungenspatel, Mundsperrer  
 Tongue depressor, Mouth Gags  
 Baja-lengua, Abrebocas  
 Abbassalingua, Apribocca



linke Seite  
 left side  
 izquierda  
 lato sinistro

rechte Seite  
 right side  
 derecha  
 lato destro

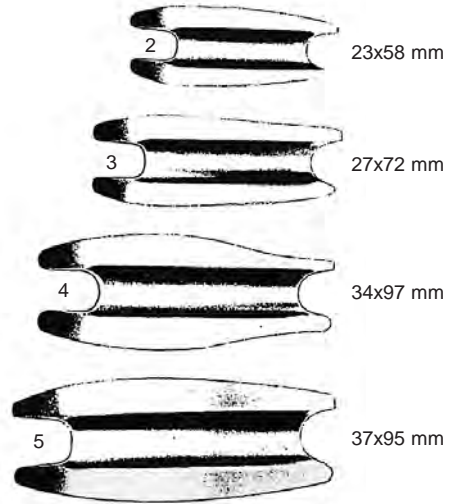

2 23x58 mm

3 27x72 mm

4 34x97 mm

5 37x95 mm

RING

- |          |        |          |
|----------|--------|----------|
| 49287-02 | Fig. 2 | 49288-02 |
| 49287-03 | Fig. 3 | 49288-03 |
| 49287-04 | Fig. 4 | 49288-04 |
| 49287-05 | Fig. 5 | 49288-05 |

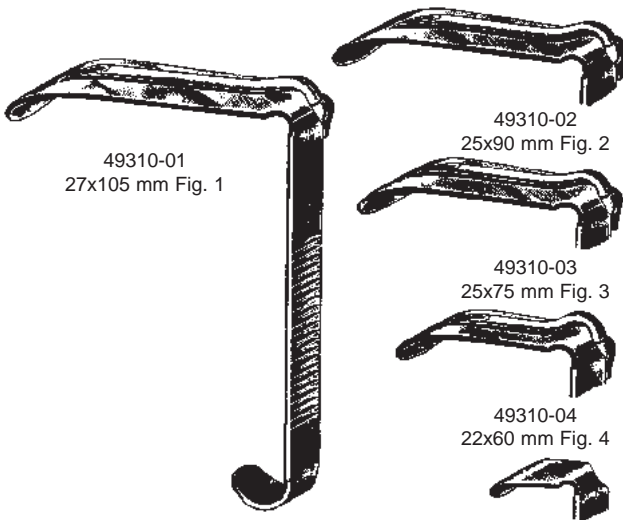

49310-01  
 27x105 mm Fig. 1

49310-02  
 25x90 mm Fig. 2

49310-03  
 25x75 mm Fig. 3

49310-04  
 22x60 mm Fig. 4

49310-05  
 20x25 mm Fig. 5

DAVIS-BOYLE  
 49310-00  
 compl.

49310-08 Silikoneinlagen/Silicone pads  
 inserto de silicona/inserto in silicone

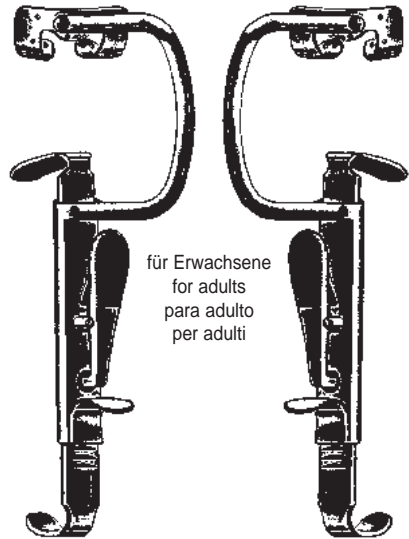

für Erwachsene  
 for adults  
 para adulto  
 per adulti

49310-10  
 Sperrer allein, links  
 Gag only, left  
 Abre-boca suelta, izquierda  
 Apribocca solo, sinistra

49310-12  
 Sperrer allein, rechts  
 Gag only, right  
 Abre-boca suelta, derecha  
 Apribocca solo, destra

Mundsperrer  
 Mouth Gags  
 Abre-Bocas  
 Apribocca

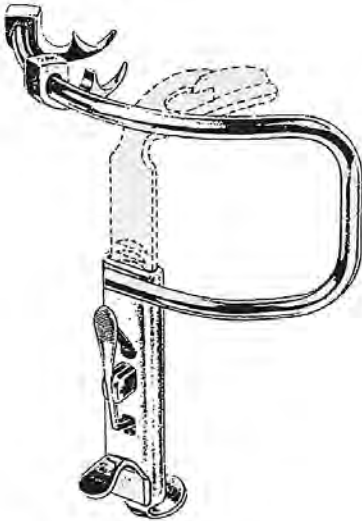

49315-10  
 Sperrer allein  
 Gag only  
 Abre-boca solo  
 Apribocca solo



49315-01  
 Fig. 1



49315-02  
 Fig. 2



49315-03  
 Fig. 3

**KILNER-DOUGHTY**  
 49315-00  
 compl.

**49317-00 DINGMANN, komplett**  
 mit 3 auswechselbaren Zungendrucker,  
 2 seitliche Wangenhaken und 2 Zahnhaken

with 3 interchangeable tongue depressors,  
 2 rotating cheek holders  
 2 movable tooth hooks and thread guide

con 3 baja lenguas intercambiables,  
 2 valvas giratorias p. los labios,  
 2 ganchos graduables

con 3 depressori intercambiabili,  
 2 valve laterali rotative  
 2 uncini a denti movibile



1 24x62 mm  
 49317-01



2 28x65 mm  
 49317-02

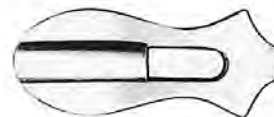

3 31x75 mm  
 49317-03

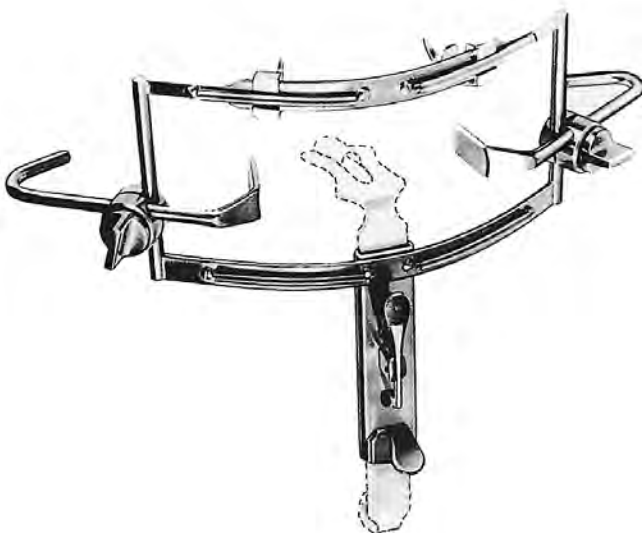

**DINGMANN**  
 49317-10  
 Sperrer allein, Gag only  
 Abre-boca solo, Apribocca solo

Mundsperrer  
 Mouth Gag  
 Abre-bocas  
 Apribocca

49320-20  
 Silikon-Schlauch  
 Silicon Tubing  
 tubo de silicona  
 tubo in silicone

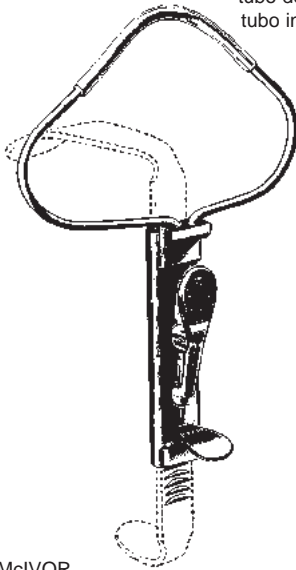

McIVOR  
 49320-00  
 compl.

49320-10



49320-01  
 27x95 mm Fig. 1



49320-02  
 22x85 mm Fig. 2



49320-03  
 22x70 mm Fig. 3



DAVIS-MEYER  
 49340-00



# MAST.SH-GERMANY

Zungenspatel  
Tongue blades  
Baja-lenguas  
Abbassalingua

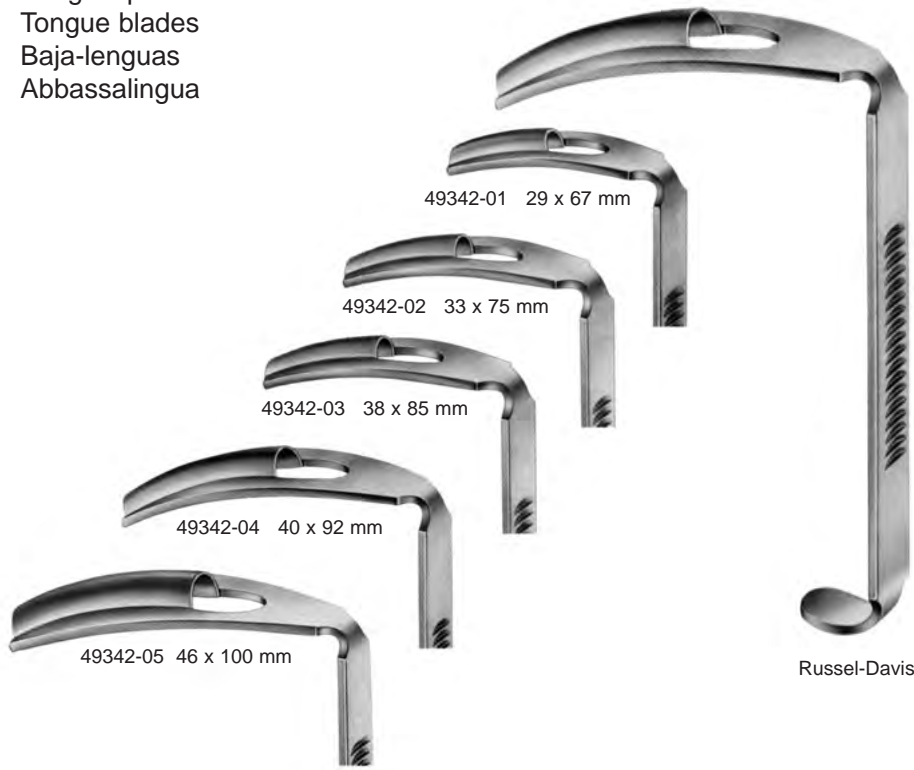

49342-01 29 x 67 mm

49342-02 33 x 75 mm

49342-03 38 x 85 mm

49342-04 40 x 92 mm

49342-05 46 x 100 mm

Russel-Davis

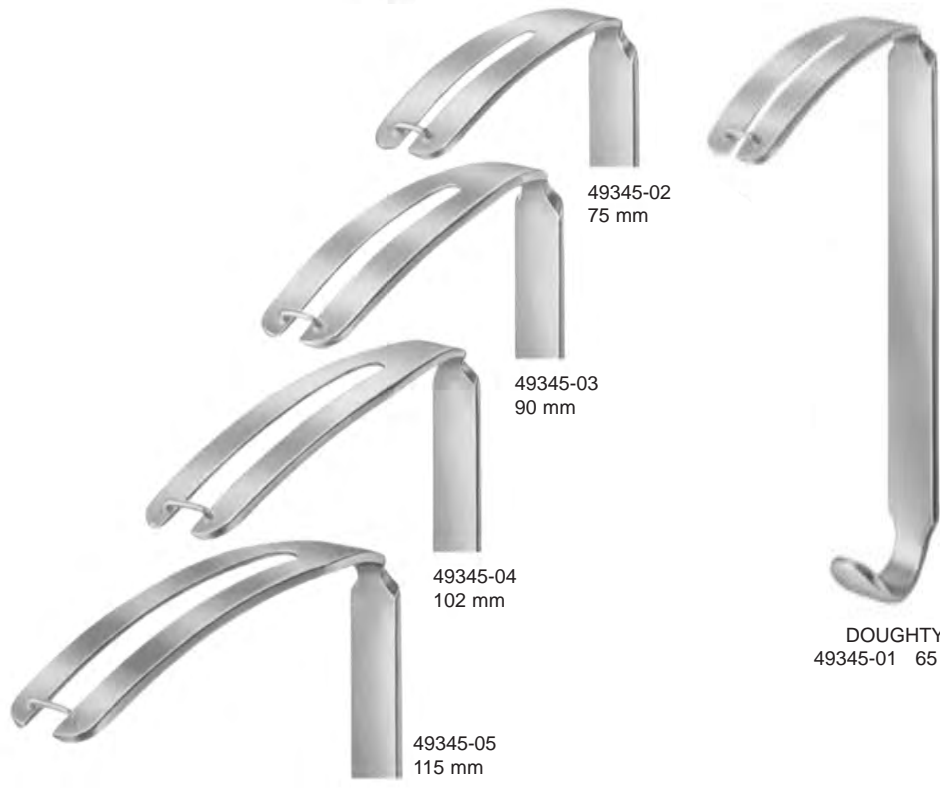

49345-02  
75 mm

49345-03  
90 mm

49345-04  
102 mm

49345-05  
115 mm

DOUGHTY  
49345-01 65 mm

Mundkeil, Repositionszangen, Bruststütze  
 Oral Wedges, Disimpaction Forceps, Chest Support  
 Pinzas para reposiciones, Soporte de pecho  
 Pinze per riposizione, Supporto per petto

Holz  
 wood  
 madera  
 legno



MAUNDER  
 49360-10



NEGUS  
 49400-01



links  
 left side  
 izquierda  
 lato sinistro

ROWE

49501-22 22,5 cm, 8.9"  
 49501-23 23,5 cm, 9 1/4"  
 49501-24 24,0 cm, 9 1/2"

Baby, baby, bebé, lattante  
 Kind, child, niño, bambino  
 Erwachs., adult, adulto



rechts  
 right side  
 derecha  
 lato destro

ROWE

49503-22 22,5 cm, 8.9"  
 49503-23 23,5 cm, 9 1/4"  
 49503-24 24,0 cm, 9 1/2"

Wundhaken für Mund-Kiefer-Gesicht  
 Retractors for Mouth-, Jaw- and Face Surgery  
 Separadores para cirugía plástica  
 Divaricatori per chirurgia plastica



49605-07  
25x7 mm

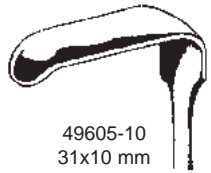

49605-10  
31x10 mm

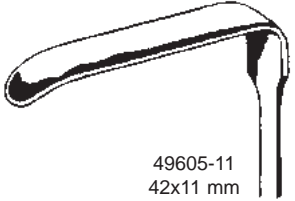

49605-11  
42x11 mm

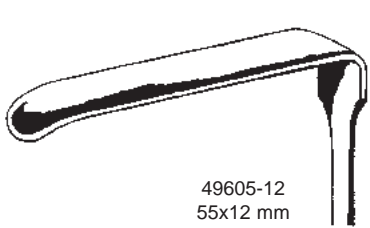

49605-12  
55x12 mm

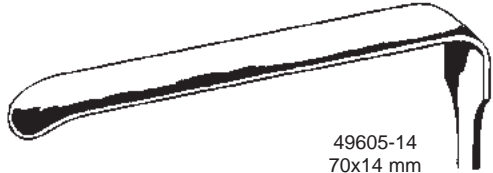

49605-14  
70x14 mm

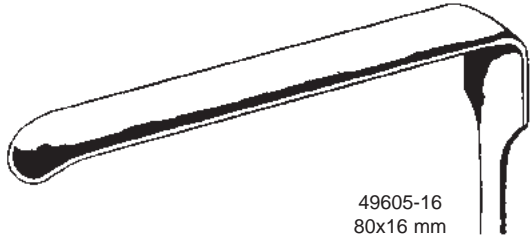

49605-16  
80x16 mm



OBWEGESER  
49605-07 - 49605-16  
22 cm, 8 3/4"

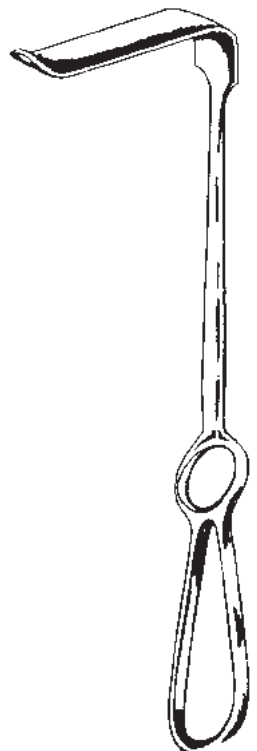

OBWEGESER  
49610-12 - 49610-16  
22 cm, 8 3/4"

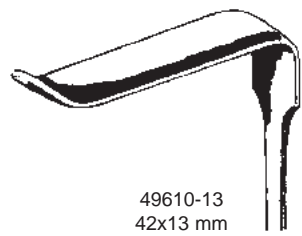

49610-13  
42x13 mm

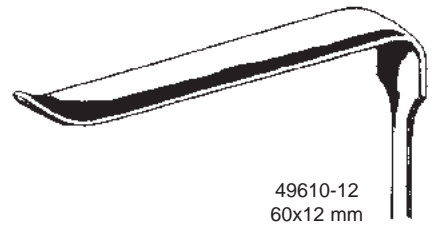

49610-12  
60x12 mm

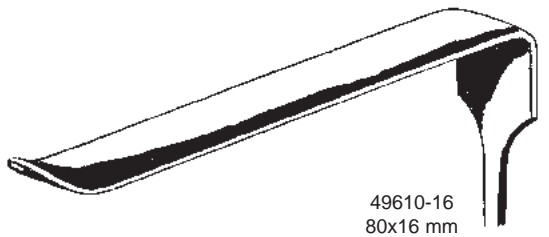

49610-16  
80x16 mm

Wundhaken für Mund-Kiefer-Gesicht  
 Retractors, Raspatories for Mouth-, Jaw- and Face Surgery  
 Separadores Periostótomos para cirugía plástica  
 Divaricatori, Periostotomi per chirurgia plastica

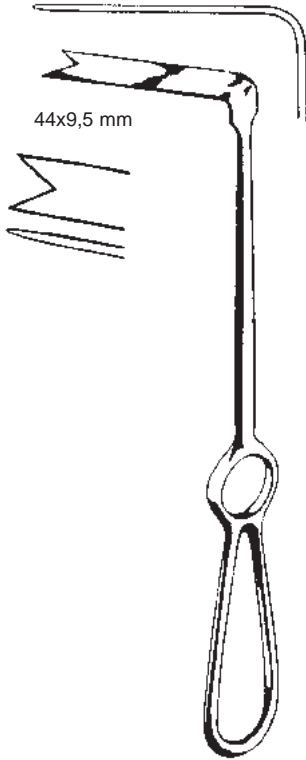

SPINA-NASALIS  
 49613-10  
 22 cm, 8 3/4"

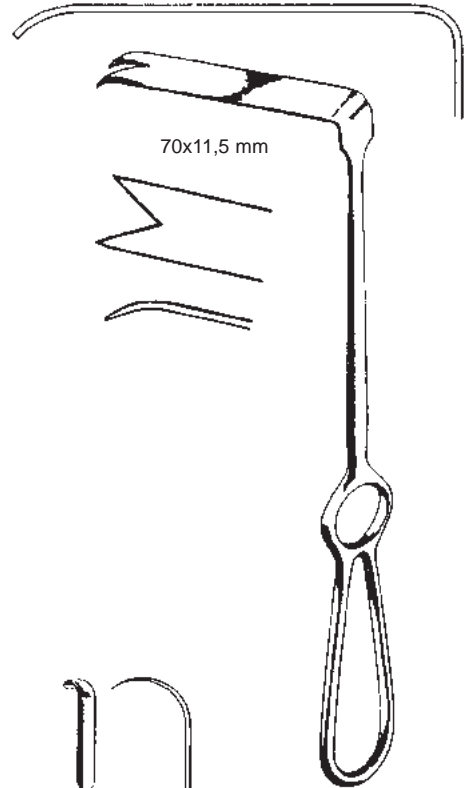

RAMUS  
 49615-12  
 22 cm, 8 3/4"



OBWEGESER  
 49620-15  
 15,5 cm, 6"

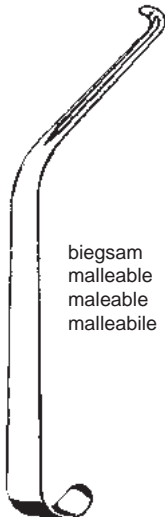

OBWEGESER  
 49623-16  
 16 cm, 6 1/4"



OBWEGESER  
 49627-01  
 21 cm, 8 1/4"

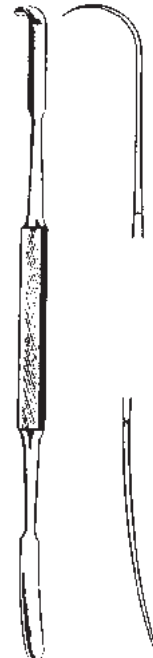

OBWEGESER  
 49630-02  
 20,5 cm, 8"

Raspatorien  
 Periosteal Elevators  
 Periostótomos  
 Periostotomi



OBWEGESER  
 49635-18  
 17,5 cm, 7"



OBWEGESER  
 49640-05 - 49640-09  
 20 cm, 8"

5 mm      7 mm      9 mm



49640-05



49640-07



49640-09



OBWEGESER  
 49650-06 - 49650-11  
 17,5 cm, 7"

6 mm



49650-06

7 mm



49650-07

9 mm



49650-09

11 mm



49650-11



Raspatorien, Osteotom, Unterkieferhaken, Ahle  
 Raspatories, Osteotome, Retractors for Mouth-, Jaw- and Face Surgery, Awls  
 Periostótomos, Osteotomos, Separadores para cirugía plástica, Agujas  
 Periostotomi, Osteotomo, Divaricatori per chirurgia plastica, Aghi

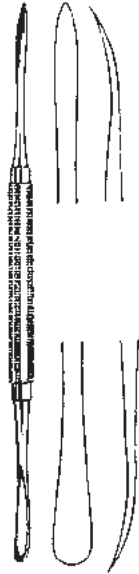

DINGMAN  
 49660-18  
 18 cm, 7"



OBWEGESER  
 49665-24  
 23,5 cm, 9 1/4"



HARGIS  
 49670-19  
 19 cm, 7 1/2"

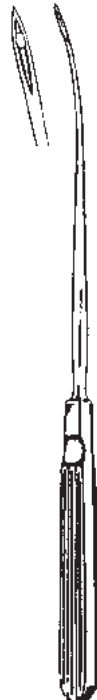
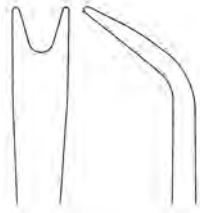

OBWEGESER  
 49670-23  
 23 cm, 9"

Intraorale Retraktoren  
 Intra Oral Retractors  
 Separadores intra orales  
 Retrattori intraorali

26,5 / 16 mm



49671-01  
 21 cm, 8 1/4"  
 rechts  
 right  
 droite  
 destra

26,5 / 16 mm



49671-02  
 21 cm, 8 1/4"  
 links  
 left  
 gauche  
 sinistra

26,5 / 16 mm



49671-01 CL  
 24,5 cm, 9 3/4"  
 rechts  
 right  
 droite  
 destra

26,5 / 16 mm



49671-02 CL  
 24,5 cm, 9 3/4"  
 links  
 left  
 gauche  
 sinistra

Raspatorien  
 Periosteal Elevators  
 Legras  
 Elevatori per periostio



HARGIS  
 23 cm, 9"



49673-01  
 6,5 mm  
 rechts  
 right  
 derecha  
 destra



49673-02  
 9 mm  
 rechts  
 right  
 derecha  
 destra



49673-03  
 6,5 mm  
 links  
 left  
 izquierda  
 sinistra

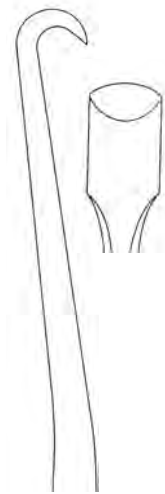

49673-04  
 9 mm  
 links  
 left  
 izquierda  
 sinistra



# MAST.SH-GERMANY

Raspatorien, Ahle, Haken  
 Raspatories, Awls, Retractors for Mouth-, Jaw- and Face Surgery  
 Periostótomos, Agujas, Separadores para cirugía plástica  
 Periostotomi, Aghi, Divaricatori per chirurgia plastica



OBWEGESER  
 49675-18  
 18 cm, 7"

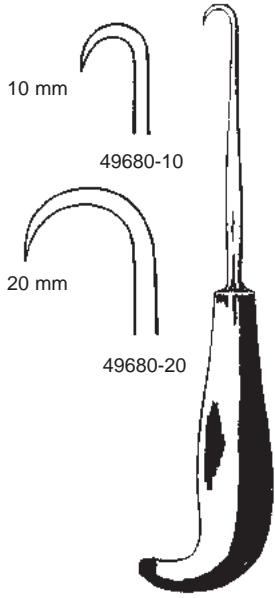

19 cm, 7 1/2"



DINGMAN  
 49685-21  
 21 cm, 8 1/4"

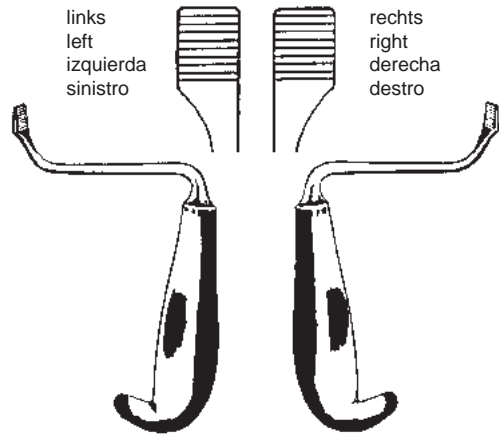

TESSIER  
 49691-15  
 15 cm, 6"

TESSIER  
 49692-15  
 15 cm, 6"

Intraorale Retraktoren  
Intra Oral Retractors  
Separadores intra orales  
Retrattori intraorali



Sagittalspreizer  
Sagittal Split Separators  
Separadores sagitales  
Separatori sagittali

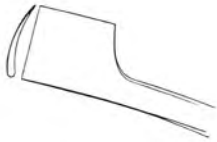

SMITH  
49695-01  
18,5 cm, 7 1/4"  
9 mm  
rechts  
right  
derecha  
destra



SMITH  
49695-02  
18,5 cm, 7 1/4"  
9 mm  
links  
left  
izquierda  
sinistra

Unterkieferkörperhaken  
Mandibular Body Retractor  
Separador para el cuerpo mandibular  
Separatore per il corpo mandibolare



HARGIS  
49696-18  
18 cm, 7"

Osteotome  
Osteotome  
Osteótomos  
Osteotomi



49700-01  
21,5 cm, 8 1/2"



49700-02  
21,5 cm, 8 1/2"



Blattosteotom  
Blade Osteotomes  
Osteótomos de hoja  
Osteotomo a lama



OBWEGESER  
22 cm, 8 3/4"



49705-08  
8 mm



49705-12  
12 mm



49705-16  
16 mm

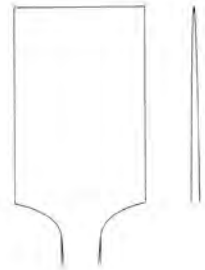

49705-20  
20 mm

Osteotome  
 Osteotome  
 Osteótomos  
 Osteotomi

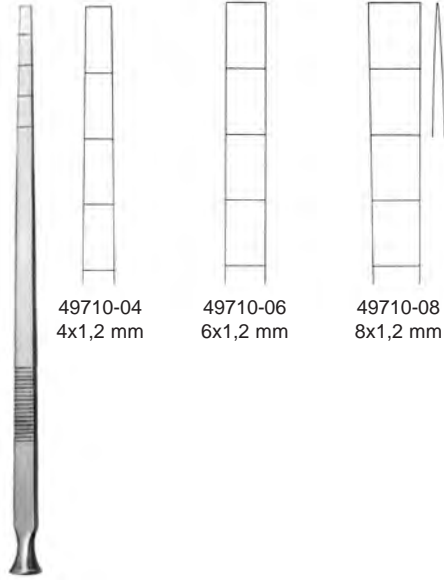

EPKER  
 18 cm, 7"

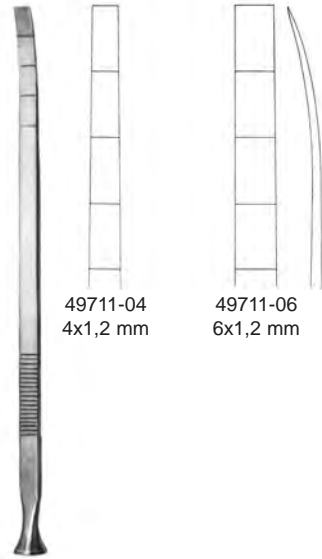

EPKER  
 18 cm, 7"

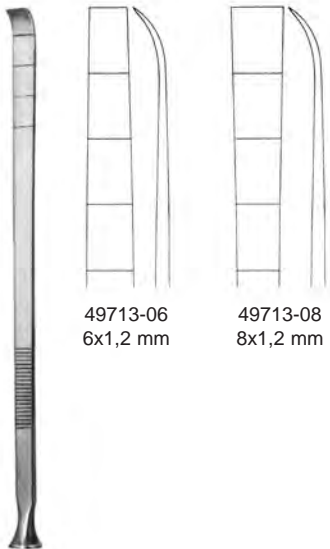

EPKER  
 18 cm, 7"

Wundhaken, Tonsillen-Elevatoren, Tamponstopfer  
 Retractors, Tonsil-Elevators, Gauze packer  
 Separadores, Elevadores para amígdalas, Tamponeador  
 Divaricatori, Elevatori, Tamponatore

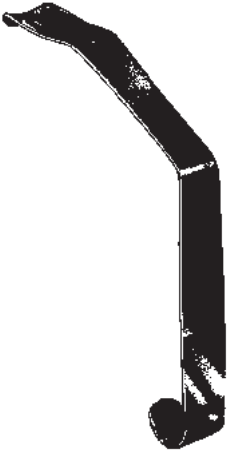

**LOVE** 15 cm, 6"  
 51103-18 18 mm  
 51103-20 20 mm  
 51103-22 22 mm



**HOFER**  
 51109-24  
 24 cm, 9 1/2"



**NAGER**  
 51111-23  
 23 cm, 9"



**HURD**  
 51131-22  
 22 cm, 8 1/4"



**LOPEZ-REINKE**  
 51133-23  
 23 cm, 9"



**YANKAUER**  
 51134-21  
 21 cm, 8 1/4"



51135-01



51135-02



**HENKE**  
 23 cm, 9"



**CARPENTER**  
 51139-25  
 25 cm, 10"



**CARPENTER**  
 51143-24  
 24 cm, 9 1/2"



**LUNIATSCHEK**  
 51151-19  
 19 cm, 7 1/2"



Tonsillen-Nadeln, Tonsillen-Messer

Tonsil Needles, Tonsil-Knives

Agujas para suturas de amígdalas, Bisturios para amígdalas

Aghi per tonsille, Coltelli per tonsille

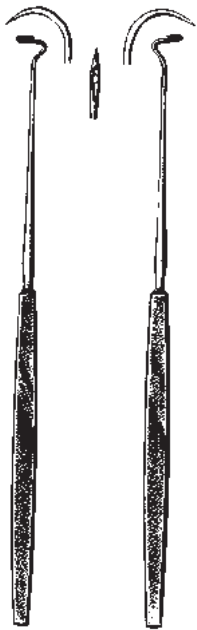

**DUPUY-WEISS**  
51165-22 51167-22  
22 cm, 8 3/4"



**CLAUS**  
51168-23  
23 cm, 9"



**CLAUS-EICKEN**  
51169-23  
23 cm, 9"



**NAGER**  
51170-24  
24 cm, 9 1/2"



**FISHER**  
51171-22  
22,5 , 9"



**ABRAHAM**  
51172-19  
19 cm, 7 1/2"



**ABRAHAM**  
51173-21  
21 cm, 8 1/4"



**CANFIELD**  
51174-21  
21 cm, 8 1/4"



**BRUENINGS**  
51177-23  
23 cm, 9"



**DOUGLAS**  
51178-21  
21 cm, 8 1/4"



**DOUGLAS**  
51179-17  
17 cm, 6 3/4"

Tonsillenzange  
 Tonsil Seizing Forceps  
 Pinzas para coger las amígdalas  
 Pinze per tonsille

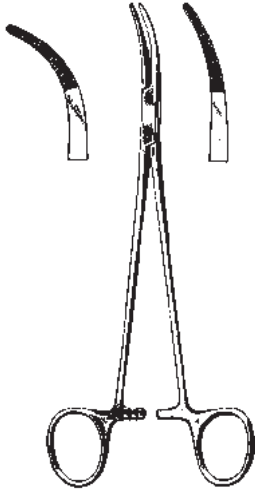

19 cm, 7 1/2"  
 SAWTELL    SCHNIDT  
 51181-19    51183-19

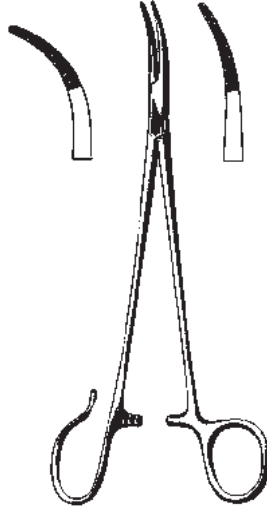

19 cm, 7 1/2"  
 SAWTELL    SCHNIDT  
 51185-19    51187-19

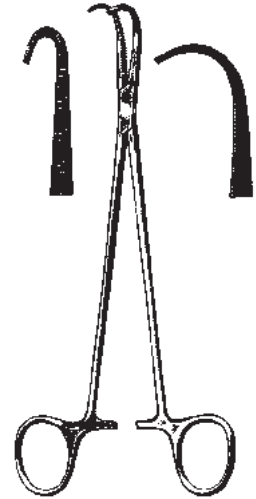

19 cm, 7 1/2"  
 NEGUS    NEGUS  
 51191-19    51193-19

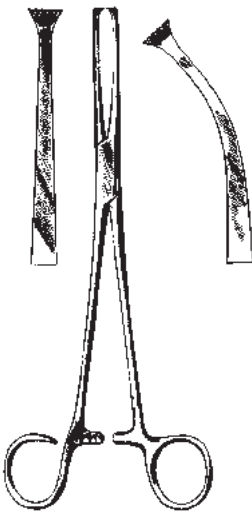

19 cm, 7 1/2"  
 COLVER  
 51202-19    51203-19

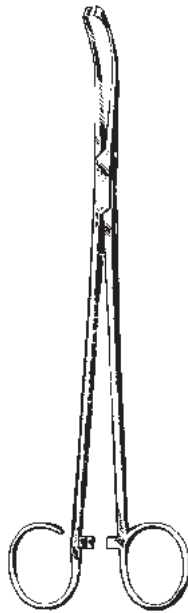

WHITE  
 51205-18    18 cm, 7"  
 51205-23    23 cm, 9"



BALLENGER  
 51207-21  
 21,5 cm, 8 1/2"

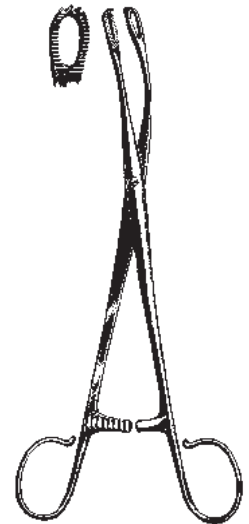

BLOHMKE  
 51209-20  
 20 cm, 8"

Tonsillen-Zangen u. -Pinzetten, Tonsillen-Kompressoren, Tonsillen-Schnürer  
 Tonsil-Forceps, Tonsil-Snares  
 Pinzas, Compresores para amígdalas, Cierra-nudos para amígdalas  
 Pinze, Compressori per tonsille, Serranodi per tonsille



ABRAHAM  
 51210-20  
 20 cm, 8"

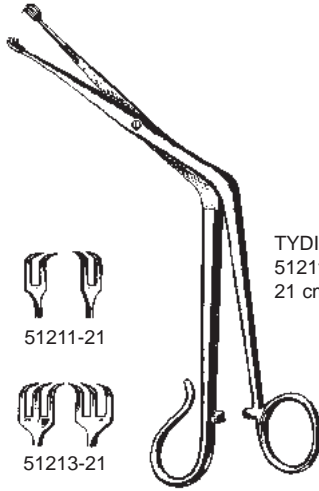

TYDING  
 51211-21 - 51213-21  
 21 cm, 8 1/4"



51211-21



51213-21



MARSCHIK  
 51219-22  
 22 cm, 8 3/4"



EVES  
 51250-28  
 28 cm, 11"



EVES  
 51252-28  
 28 cm, 11"



BRUENINGS  
 51256-28  
 28 cm, 11"



51257-40 40 mm  
 51257-50 50 mm  
 Pack of 100 pcs



51259-03 0,3 mm  
 51259-04 0,4 mm  
 51259-05 0,5 mm  
 Pack of 12 pcs

Tonsillotom  
Tonsillectomes  
Amigdalótomos  
Tonsillotomi

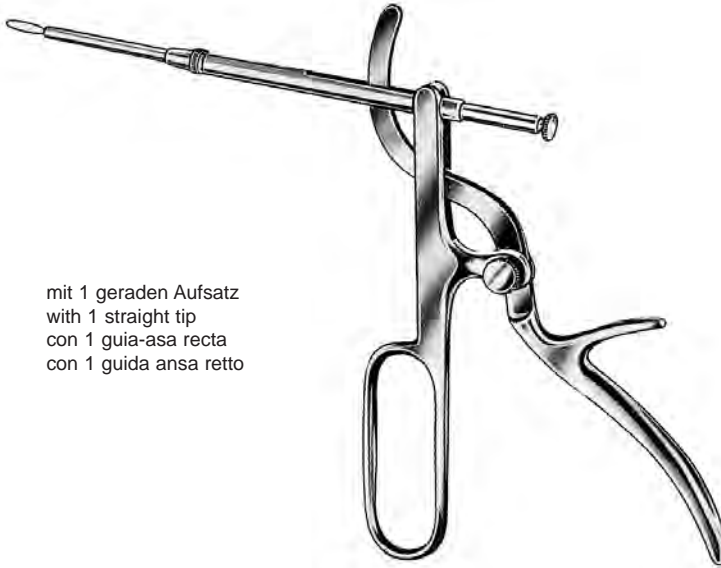

mit 1 geraden Aufsatz  
with 1 straight tip  
con 1 guida-asa recta  
con 1 guida ansa retto

TYDING  
51260-00

Tonsillotom, Spritzen, Septum Nadeln  
 Tonsillectomes, Syringes, Septum needles  
 Amigdalótomos, Jeringas, Septum aguja  
 Tonsillotomi, Siringhe, Septum aghi

Aufsatz allein  
 blade only  
 hoja sola  
 lama sola

51270-01



1

51270-02



2

51270-03



3

51270-04  
 Handgriff allein  
 Handle only  
 mango para  
 manipolo solo

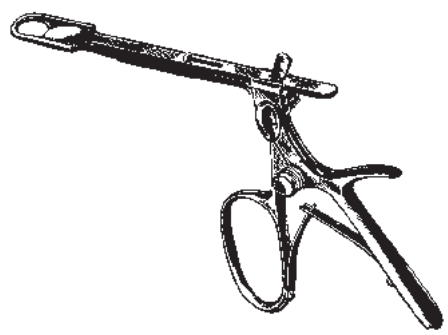

SLUDER-BALLENGER  
 51270-00  
 mit 3 Aufsätzen  
 with 3 blades  
 con 3 hojas  
 con 3 lame

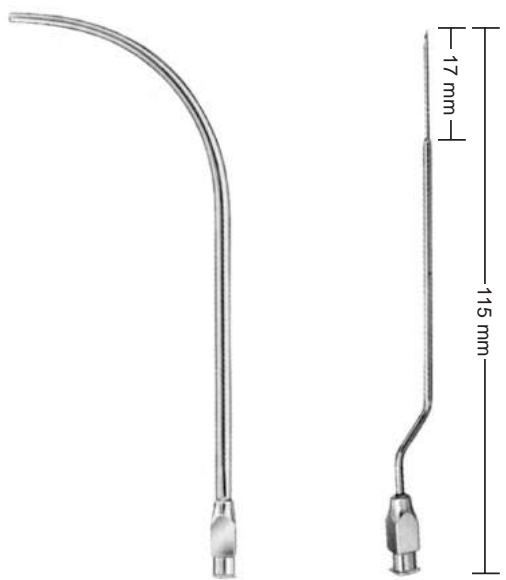

51291-00  
 2,5 mm Ø

51293-00  
 0,8 mm Ø

17 mm  
 115 mm

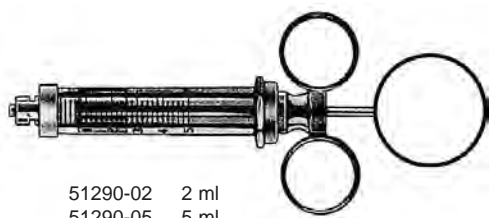

51290-02 2 ml  
 51290-05 5 ml  
 51290-10 10 ml  
 51290-20 20 ml



51292-00



51293-45  
 45°



51293-90  
 90°



Septum-Schere, Kehlkopfpolypenzangen, Deckelhalter  
 Septum-Scissors, Laryngeal Polypus Forceps, Epiglottis Retractor  
 Tijeras para septo, Pinzas para pólipos laríngeos, Depresor para epiglotis  
 Forbice per il setto nasale, Pinze per polipi laringei, Depressore per epiglottide



**KILLIAN**  
 53102-20  
 20 cm, 8"



53101-22



53103-22



**JACKSON**  
 53101-22 - 53103-22  
 22 cm, 8 3/4"

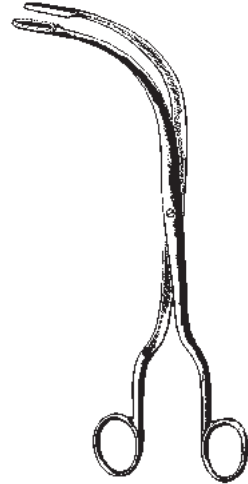

**FRAENKEL**  
 53111-18  
 18 cm, 7"

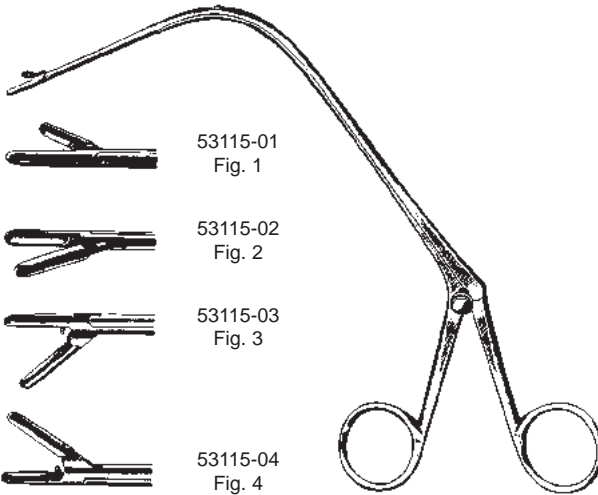

**JURASZ**  
 53115-01 - 53115-04  
 23 cm, 9"



53115-01  
 Fig. 1



53115-02  
 Fig. 2



53115-03  
 Fig. 3



53115-04  
 Fig. 4



**REICHERT**  
 53121-24  
 24 cm, 9 1/2"



# MAST.SH-GERMANY

Universalgriffe, Verlängerungsrohre, Aufsätze  
 Universal Handles, Interchangeable Tips, Tips  
 Mangos universales y Tubos de extension, Puntas  
 Manici universali e Tubi di prolungamento, Terminale laringeo

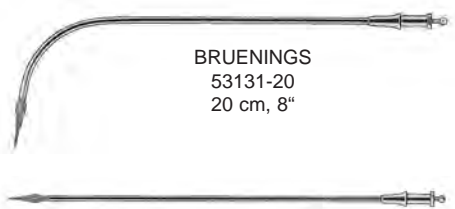

**BRUENINGS**  
 53131-20  
 20 cm, 8"



**BRUENINGS**  
 53132-20 20 cm, 8"    53132-50 50 cm, 19 3/4"  
 53132-30 30 cm, 11 3/4"    53132-60 60 cm, 23 1/2"  
 53132-40 40 cm, 15 3/4"



**HUBER**  
 53130-00



**FRAENKEL**  
 53150-00



**SEIFERT**  
 53152-00



**FRAENKEL**  
 53154-00



**SCHEINMANN**  
 53155-00



**SCHEINMANN**  
 53157-00



○ 53158-02  
 ○ 53158-03  
**BRUENINGS**  
 53158-02 - 53158-03

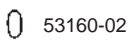

53160-02

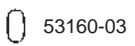

53160-03



**BRUENINGS**  
 53160-02 - 53160-03



**LANGE**  
 53162-00



53164-01



53164-02



**KRAUSE**  
 53164-01 - 53164-02



**KRAUSE**  
 53166-00



**SCHUMACHER**  
 53170-00



**BARACANI**  
 53175-00



53177-01



53177-02



**CORDES**  
 53177-01 - 53177-02



Broncho-Oesophagoskopiezangen, Kehlkopfspiegel, Griffe  
 Broncho-Esophoscopy Forceps, Laryngeal Mirrors, Handles  
 Pinzas para bronco-esofagoscopia, Espejos laringeos, Mangos  
 Pinze per bronco-esofagoscopia, Specchi laringei, Manici

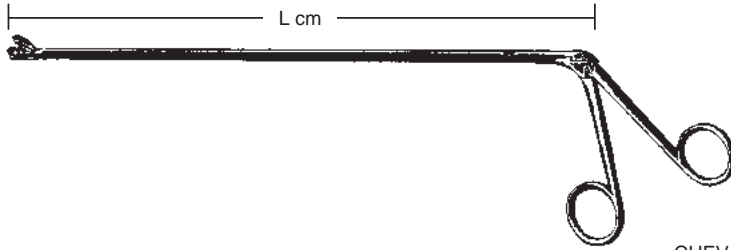

CHEVALIER-JACKSON  
 53230-01 - 53260-08



cm	Fig. 1	Fig. 2	Fig. 3	Fig. 4	Fig. 5	Fig. 6	Fig. 7	Fig. 8
30 / 11 3/4"	53230-01	53230-02	53230-03	53230-04	53230-05	53230-06	53230-07	53230-08
40 / 15 3/4"	53240-01	53240-02	53240-03	53240-04	53240-05	53240-06	53240-07	53240-08
50 / 19 3/4"	53250-01	53250-02	53250-03	53250-04	53250-05	53250-06	53250-07	53250-08
60 / 23 1/2"	53260-01	53260-02	53260-03	53260-04	53260-05	53260-06	53260-07	53260-08

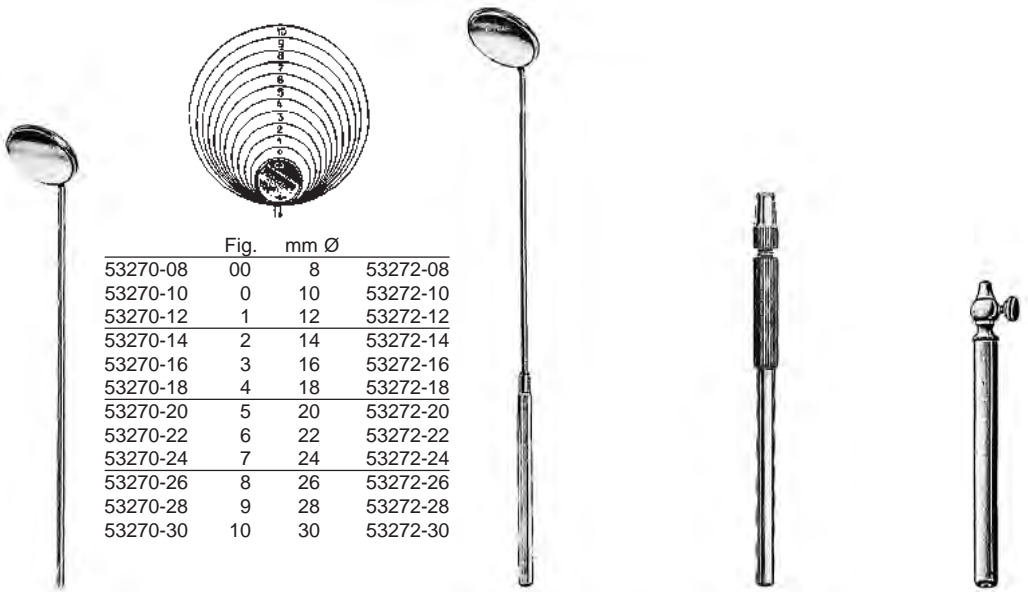

	Fig.	mm Ø	
53270-08	00	8	53272-08
53270-10	0	10	53272-10
53270-12	1	12	53272-12
53270-14	2	14	53272-14
53270-16	3	16	53272-16
53270-18	4	18	53272-18
53270-20	5	20	53272-20
53270-22	6	22	53272-22
53270-24	7	24	53272-24
53270-26	8	26	53272-26
53270-28	9	28	53272-28
53270-30	10	30	53272-30

53270-08 - 53270-30

53272-08 - 53272-30

53274-12

53276-10

Mikro-Rohrschaftzangen  
 Micro Laryngeal Forceps  
 Pinzas para la micro-cirugía de la laringe  
 Pinze ad asta tubolare per microchirurgia

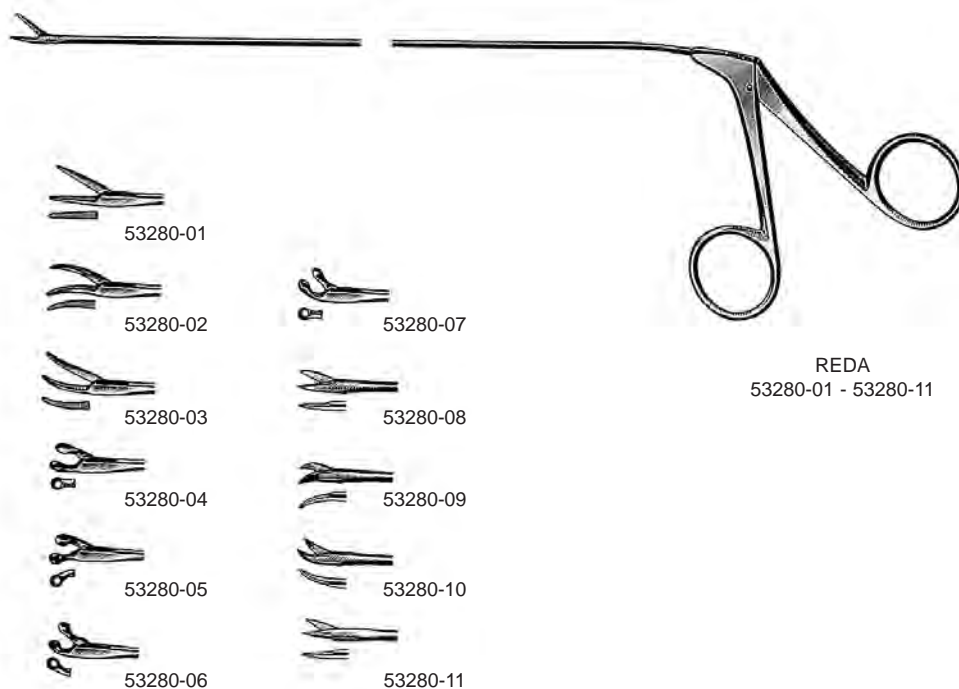

REDA  
 53280-01 - 53280-11

**REDA Mikro-Rohrschaftzangen 22 cm (8 3/4")**

- 53280-01 gerieftes Maul, gerade 1,5 x 10 mm
- 53280-02 gerieftes Maul, links gebogen 1,5 x 8,5 mm
- 53280-03 gerieftes Maul, rechts gebogen 1,5 x 8,5 mm
- 53280-04 Löffelmaul, gerade 2,5 mm
- 53280-05 Löffelmaul, links abgewinkelt 2,5 mm
- 53280-06 Löffelmaul, rechts abgewinkelt 2,5 mm
- 53280-07 Löffelmaul, aufwärts abgewinkelt 2,5 mm
- 53280-08 Schere, gerade, vertikal
- 53280-09 Schere, links gebogen
- 53280-10 Schere, rechts gebogen
- 53280-11 Schere, horizontal schneidend, gerade

**REDA Micro-Laryngeal Forceps 22 cm (8 3/4")**

- 53280-01 Grasping tip, straight, serrated, 1,5 x 10 mm
- 53280-02 Grasping tip, curved to left, serrated, 1,5 x 8,5 mm
- 53280-03 Grasping tip, curved to right, serrated, 1,5 x 8,5 mm
- 53280-04 Cup forceps, straight, 2,5 mm
- 53280-05 Cup forceps, angled to left, 2,5 mm
- 53280-06 Cup forceps, angled to right, 2,5 mm
- 53280-07 Cup forceps, angled up, 2,5 mm
- 53280-08 Scissors, straight, vertical
- 53280-09 Scissors, curved to left
- 53280-10 Scissors, curved to right
- 53280-11 Scissors, straight, horizontal

**REDA Pinza microlaringea 22 cm (8 3/4")**

- 53280-01 boca estriada recta 1,5 x 10 mm
- 53280-02 boca estriada curva a la izquierda 1,5 x 8,5 mm
- 53280-03 boca estriada curva a la derecha 1,5 x 8,5 mm
- 53280-04 boca redonda cortante recta 2,5 mm Ø
- 53280-05 boca redonda cortante angulada al la izquierda 2,5 mm Ø
- 53280-06 boca redonda cortante angulada a la derecha 2,5 mm Ø
- 53280-07 boca redonda cortante angulada hacia arriba 2,5 mm Ø
- 53280-08 Tijera recta corte vertical
- 53280-09 Tijera curva a la izquierda
- 53280-10 Tijera curva a la derecha
- 53280-11 Tijera recta corte horizontal

**REDA Pinze ad asta tubolare per microchirurgia 22 cm (8 3/4")**

- 53280-01 morsi zigrinati, retti, 1,5 x 10 mm
- 53280-02 morsi zigrinati, curvi a sinistra, 1,5 x 8,5 mm
- 53280-03 morsi zigrinati, curvi a destra, 1,5 x 8,5 mm
- 53280-04 morsi a forma di cucchiaio rotondo retto, 2,5 mm
- 53280-05 morsi a forma di cucchiaio rotondo angolati a sinistra, 2,5 mm
- 53280-06 morsi a forma di cucchiaio rotondo angolati a destra, 2,5 mm
- 53280-07 morsi a forma di cucchiaio rotondo angolati in alto, 2,5 mm
- 53280-08 forbici, rette, taglio verticale
- 53280-09 forbici, curve a sinistra
- 53280-10 forbici, curve a destra
- 53280-11 forbici, rette, taglio orizzontale



Instrumente für Tracheotomie  
Instruments for tracheotomy  
Instrumentos tracheotomia  
Strumenti per la tracheotomia

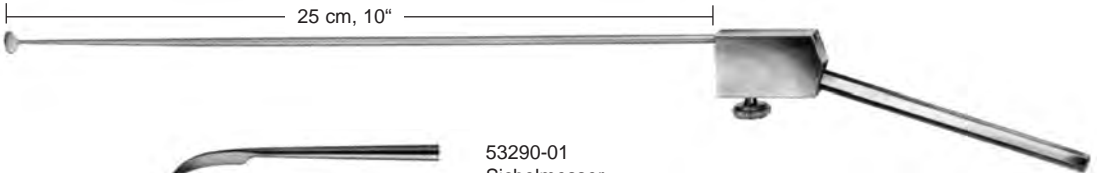

53290-01  
Sichelmesser  
micro-laryngeal sickle  
microlaringeo cuchillo de hoz  
Coltello falciato



53290-02  
Schälmesser, quer, oval  
micro-laryngeal separador oval, horizontal  
microlaringeo separador ovalado, horizontal  
Seperatore ovale verticale



53290-03  
Schälmesser, längs, oval  
micro-laryngeal separador oval, vertical  
microlaringeo separador ovalado, vertical  
Seperatore ovale orizzontale



53290-04  
Schälmesser, 45° abgewinkelt  
micro-laryngeal round cutting knife, 45° angled  
microlaringeo cuchillo para cortes redondos, 45° angulado  
Seperatore angolato 45°



53290-05  
Häkchen, 90° gebogen stumpf  
micro-laryngeal hook 90° angled, blunt  
microlaringeo ganchito 90° angulado, romo  
Uncino angolato 90° smusso



53290-06  
Häkchen, 30° retrograd gebogen  
micro-laryngeal probe, 30° backwards curved blunt with button  
microlaringeo ganchito, 30° curvo retrogrado  
Uncino angolato retrogrado 30°



53290-07  
Fadengabel  
micro-laryngeal ligatore adjuster  
microlaringeo horquilla de hilos  
Forchetta da sutura

53290-08  
Handgriff für Stabinstrumente  
Handle for microlaryngeal instruments  
Mango para microlaringeos instrumentos  
Manico per strumenti microlaringei



Tracheal Dilatatoren, Trachealhaken, Tracheal-Wundspreizer  
 Trachea Dilators, Trachea hooks, Trachel Retractors  
 Dilatadores para la tráquea, Ganchos para traqueotomía, Retractor traqueal  
 Dilatatori per tracheotomia, Ganci per tracheotomia, Divaricatori tracheali

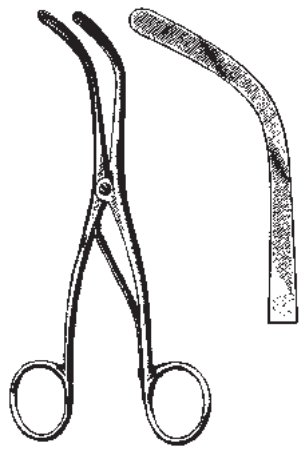

TROUSSEAU-BABY  
 55111-13 13 cm, 5 1/8"

TROUSSEAU  
 55111-14 14 cm, 5 1/2"

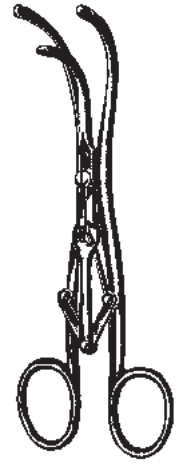

LABORDE  
 55113-14  
 14 cm, 5 1/2"



BOSE  
 55115-07  
 7 cm, 2 3/4"



JACKSON  
 55116-15  
 15 cm, 6"



JACKSON  
 55117-17  
 17 cm, 6 3/4"

Trachealhaken, Kanüle  
 Trachea Hooks, Tubes  
 Ganchos para traqueotomía, Cánula  
 Ganci per tracheotomia, Cannule



**ITERSON**  
 55118-16 - 55119-16  
 16 cm, 6 1/4"



**NEWS**  
 55120-15  
 15 cm, 6"

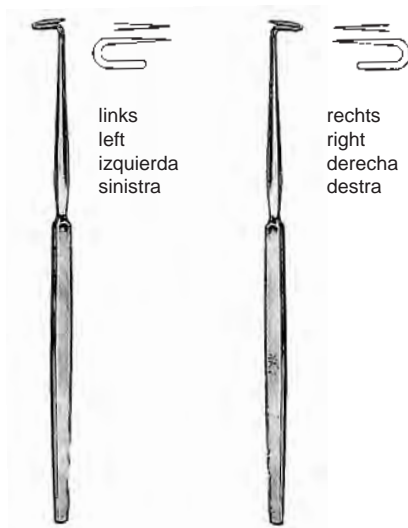

**BOSE**  
 55122-16  
 16 cm, 6 1/4"

**BOSE**  
 55124-16  
 16 cm, 6 1/4"



**WAGENER-MOSHER**  
 55151-05 5 mm  
 55151-07 7 mm  
 55151-09 9 mm

Tracheotomie-Besteck  
Tracheotomy Set  
Estuche para Traqueotomía  
Set per Tracheotomia

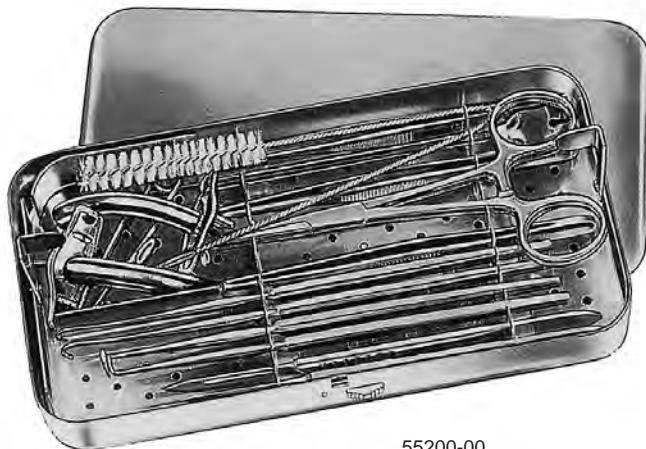

55200-00

**Tracheotomie-Besteck**

in Metall-Etui, bestehend aus:

- 1 Griff und 1 Klinge, Fig. 20
- 1 Griff und 1 Klinge, Fig. 23
- 1 anat. Pinzette, 13 cm (5 1/8")
- 2 chir. Pinzetten, 13 cm (5 1/8"), 1x2 Zähne
- 2 Pean-Klemmen, 13 cm (5 1/8")
- 1 Hohlsonde, 13 cm (5 1/8")
- 1 Trachealdilatator
- 2 Trachealhäkchen Iterson stumpf
- 1 Trachealhäkchen Bose scharf, links
- 1 Trachealhäkchen Bose scharf, rechts
- 1 Trachealkanüle Luer Standard, Fig. 3
- 1 Trachealkanüle Luer Standard, Fig. 4
- 1 Reinigungsbürste

**Estuche para Traqueotomía**

en estuche de metal, compuesto de:

- 1 Mango con 1 hoja fig. 20
- 1 Mango con 1 hoja fig. 23
- 1 Pinza de disección, 13 cm (5 1/8")
- 1 Pinza de disección, con 1x2 dientes de ratón, 13 cm (5 1/8")
- 2 Pinzas hemostáticas Pean, 13 cm (5 1/8")
- 1 Sonda acanalada, 13 cm (5 1/8")
- 1 Dilatador traqueal
- 2 Iterson separadores traqueales, romos
- 1 Bose separador traqueal, agudo, lado izquierdo
- 1 idem, lado derecho
- 1 Luer Cánula traqueal, modelo standard, Fig. 3
- 1 idem, Fig. 4
- 1 Cepillo de limpieza

**Tracheotomy Set**

in metal case, consisting of:

- 1 Handle with 1 blade, Fig. 20
- 1 Handle with 1 blade, Fig. 23
- 1 Thumb Forceps, 13 cm (5 1/8")
- 1 Tissue Forceps, 13 cm (5 1/8"), 1x2 teeth
- 2 Pean Artery Forceps, 13 cm (5 1/8")
- 1 Grooved Director, 13 cm (5 1/8")
- 1 Trachea Dilator
- 1 Iterson Trachea Retractors, blunt
- 1 Bose Trachea Retractor, sharp, left hand side
- 1 ditto, right hand side
- 1 Luer Trachea Tube, Standard, Fig. 3
- 1 ditto, Fig. 4
- 1 Cleaning Brush

**Set per tracheotomia**

in scatola di metallo, composto da:

- 1 Manico di bisturi con 1 lama fig. 20
- 1 Manico di bisturi con 1 lama fig. 23
- 1 Pinza per dissezione, cm 13 (5 1/8")
- 1 Pinza per dissezione con denti 1x2, cm 13 (5 1/8")
- 2 Pinze emostatiche Pean, cm 13 (5 1/8")
- 1 Sonda scanalata, cm 13 (5 1/8")
- 1 Dilatatore traqueale
- 2 Uncini tracheali Iterson, smussi
- 1 Uncino tracheale Bose, acuto, lato sinistro
- 1 item, lato destro
- 1 Cannula tracheale Luer standard, Fig. 3
- 1 item, Fig. 4
- 1 Spazzolino per pulire



Tracheal-Kanülen, Schilddrüsenhaken, Sonde, Kropffabzange, Muskelklemme  
 Tracheal Tubes, Thyroid Gland Retractor, Directors-Enucleators, Goitre Seizing Forceps, Muscular Clamp  
 Cánulas traqueales, Separador para la glándula tiroidea, Sondas acanaladas,  
 Pinza para coger el bocio, Pinza-clamp para músculos  
 Cannule tracheali, Divaricatori per la tiroide, Sonde, Pinze per gozzo, Pinza muscolare



**LUER**

Neusilber  
 German silver  
 alpaca  
 argentone  
 45-90 mm  
 55220-04  
 55220-05  
 55220-06  
 55220-07  
 55220-08  
 55220-09  
 55220-10  
 55220-11  
 55220-12  
 55220-13

**CHEVALIER-JACKSON**

Neusilber  
 German silver  
 alpaca  
 argentone  
 45-90 mm  
 55240-04  
 55240-05  
 55240-06  
 55240-07  
 55240-08  
 55240-09  
 55240-10  
 55240-11  
 55240-12  
 55240-13

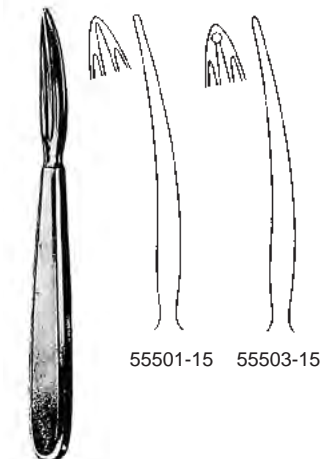
Fig.	Ø mm	Länge des Außenrohrs Length of outer tube Largo de la cánula exterior Lunghezza del tubo esterno
0	4	45
1	5	50
2	6	55
3	7	60
4	8	65
5	9	70
6	10	75
7	11	80
8	12	85
9	13	90



**KOCHER**  
 55501-15 - 55503-15  
 15 cm, 6"



**SCHOENBORN**  
 55511-21  
 21 cm, 8 1/4"



**LAHEY**  
 55520-15 15 cm, 6"  
 55520-20 20 cm, 8"

**MASTIN**  
 55523-17  
 17 cm, 6 3/4"

Rippenscheren, Sternummeißel  
 Rib Shears  
 Costótomos  
 Costotomi



57102-23  
 23 cm, 9"



57105-22  
 22 cm, 8 3/4"



mit ziehendem Schnitt  
 with eccentric sliding blade  
 con hoja de retroacción  
 con lama di retroazione

GLUCK  
 57107-22  
 22 cm, 8 3/4"



STILLE  
 57111-21  
 21 cm, 8 1/4"



CORYLLOS  
 57125-35  
 35 cm, 13 3/4"

CORYLLOS  
 57123-35  
 35 cm, 13 3/4"

Rippenscheren, Sternumscheren  
 Rib Shears, Sternum Scissors  
 Costótomos, Tijeras de esternón  
 Costotomi, Forbici per sterno



**BETHUNE**  
 57126-34  
 34 cm, 13 1/2"



**SAUERBRUCH**  
 57131-26  
 26 cm, 10 1/4"



**GIERTZ-STILLE**  
 57137-27  
 27 cm, 10 1/2"



**SCHUMACHER**  
 57138-21  
 21 cm, 8 1/4"



**SAUERBRUCH-FREY**  
 57141-36  
 36 cm, 14.2"

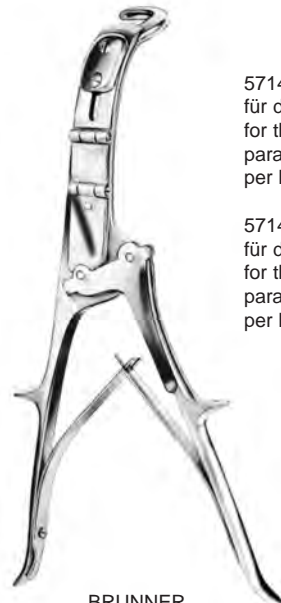

**BRUNNER**  
 57146-28 - 57147-28  
 28 cm, 11"

57146-28  
 für die rechte Hand  
 for the right hand  
 para la mano derecha  
 per la mano destra

57147-28  
 für die linke Hand  
 for the left hand  
 para la mano izquierda  
 per la mano sinistra

Rippensperrer  
 Rib Spreaders  
 Separadores costales  
 Divaricatori costali

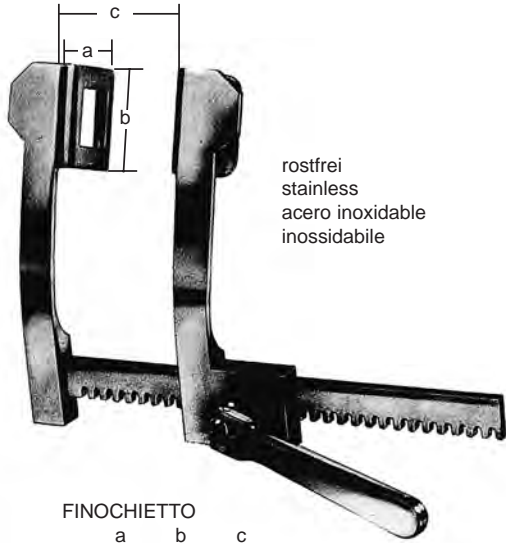

rostfrei  
 stainless  
 acero inoxidable  
 inossidabile

FINOCHIETTO

	a	b	c
	mm	mm	mm
57210-16	38	44	160
57210-20	52	62	200
57210-25	65	85	250

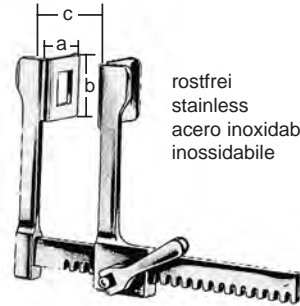

rostfrei  
 stainless  
 acero inoxidable  
 inossidabile

FINOCHIETTO-BABY

	a	b	c
	mm	mm	mm
57214-75	18	20	75

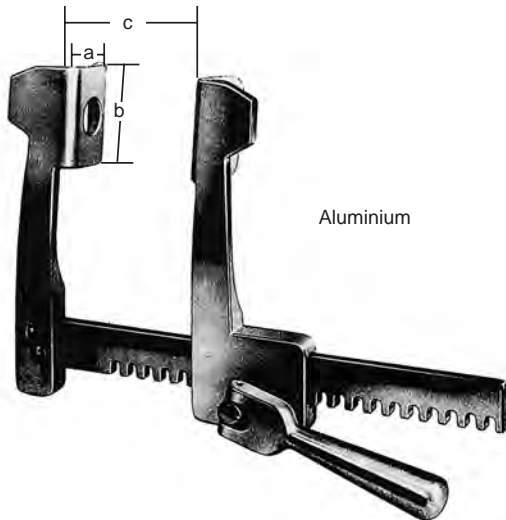

Aluminium

FINOCHIETTO

	a	b	c
	mm	mm	mm
57230-13	38	44	135
57230-17	52	62	175
57230-18	85	65	175

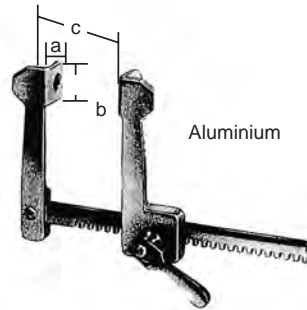

Aluminium

FINOCHIETTO-BABY

	a	b	c
	mm	mm	mm
57234-75	15	15	75

Rippensperrer  
 Rib Spreaders  
 Separadores costales  
 Divaricatori costali

**FINOCHIETTO-BURFORD**

	a	b	c
	mm	mm	mm
57236-20	65	62	200
	47	62	
57236-25	65	62	250
	47	62	
57236-30	65	62	300
	47	52	



rostfrei  
 stainless  
 acero inoxidable  
 inossidabile

Erwachsene  
 Adult Size  
 para adultos  
 per adulti

**FINOCHIETTO-BURFORD**

	a	b	c
	mm	mm	mm
57242-20	47	62	200
	65	62	
57242-25	47	62	250
	65	62	
57242-30	47	62	300
	65	62	



Aluminium

Kinder  
 Child Size  
 para niños  
 per bambini

**FINOCHIETTO-BURFORD**

	a	b	c
	mm	mm	mm
57244-13	34	42	135
	48	42	



Aluminium



# MAST.SH-GERMANY

Rippensperrer  
Rib Spreaders  
Separadores costales  
Divaricatori costali

FINOCHIETTO

	a	b	c
	mm	mm	mm
57245-13	14	14	120

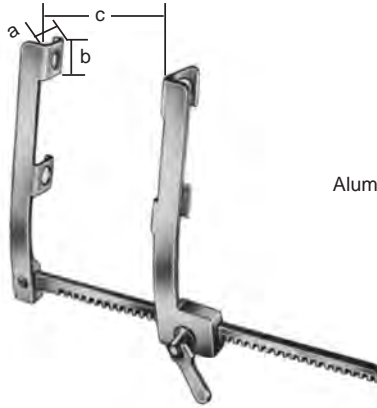

Aluminium

MORSE

	a	b	c
	mm	mm	mm
57246-16	17	22	160

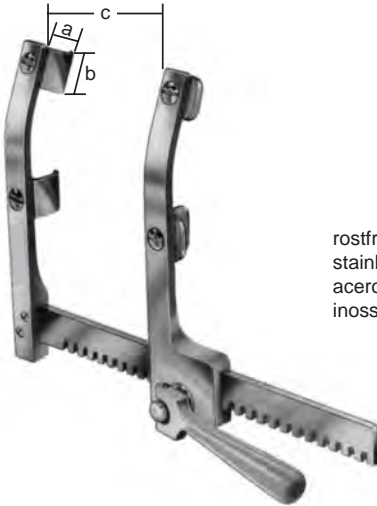

rostfrei  
stainless  
acero inoxidable  
inossidabile

MORSE-FAVALORO

	a	b	c
	mm	mm	mm
57246-21	19	27	210



rostfrei  
stainless  
acero inoxidable  
inossidabile

Rippensperrer  
Rib Spreaders  
Separadores costales  
Divaricatori costali

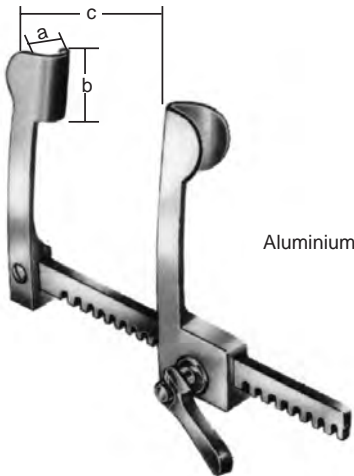

Aluminium

COOLEY-NEONATAL

	a	b	c
	mm	mm	mm
57247-95	12	16	95

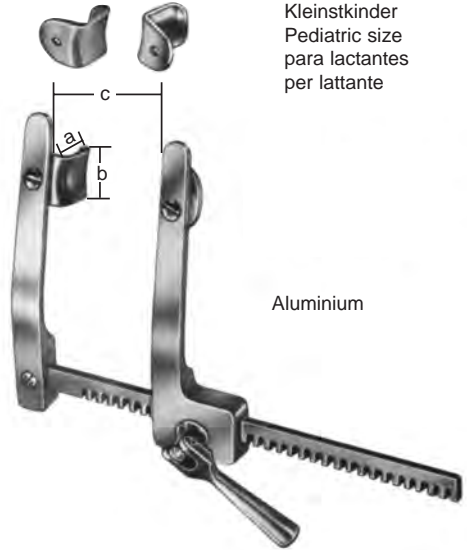

Aluminium

Kleinstkinder  
Pediatric size  
para lactantes  
per lattante

COOLEY

	a	b	c
	mm	mm	mm
57249-01	10	14	90

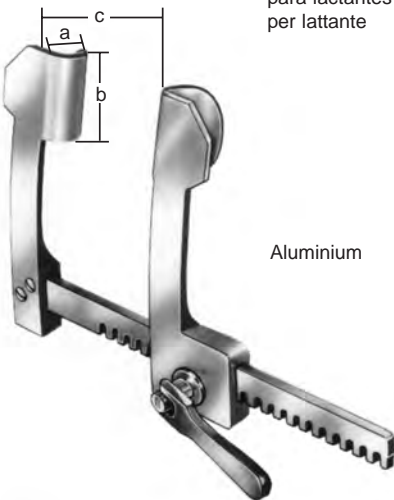

Aluminium

Kleinstkinder  
Pediatric size  
para lactantes  
per lattante

COOLEY

	a	b	c
	mm	mm	mm
57248-14	15	30	140

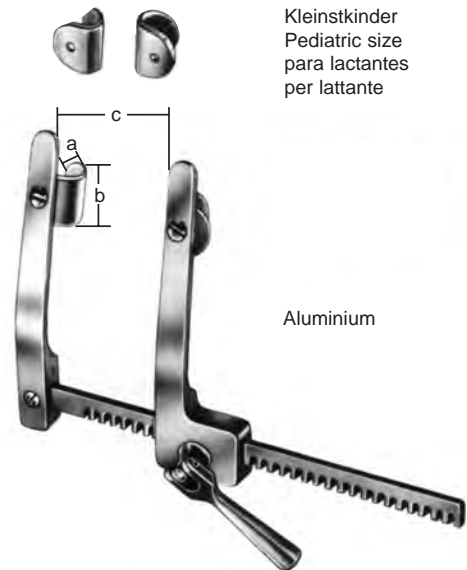

Aluminium

Kleinstkinder  
Pediatric size  
para lactantes  
per lattante

COOLEY

	a	b	c
	mm	mm	mm
57249-02	10	14	90

Rippensperrer rostfrei  
 Rib Spreaders stainless  
 Separadores costales acero inoxidable  
 Divaricatori costali inossidabile

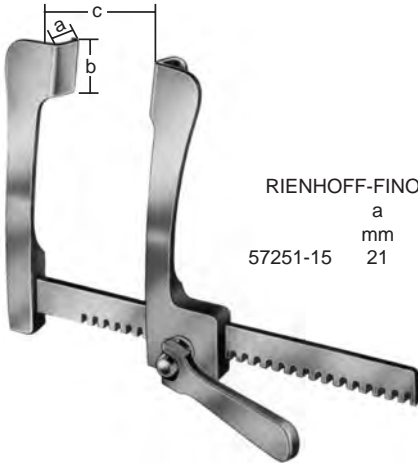

RIENHOFF-FINOCHIETTO

	a	b	c
	mm	mm	mm
57251-15	21	26	150

rostfrei  
 stainless  
 acero inoxidable  
 inossidabile



DE BOER

	a	b	c
	mm	mm	mm
57252-19	27	100	190

rostfrei  
 stainless  
 acero inoxidable  
 inossidabile



Rippensperrer rostfrei  
 Rib Spreaders stainless  
 Separadores costales acero inoxidable  
 Divaricatori costali inossidabile

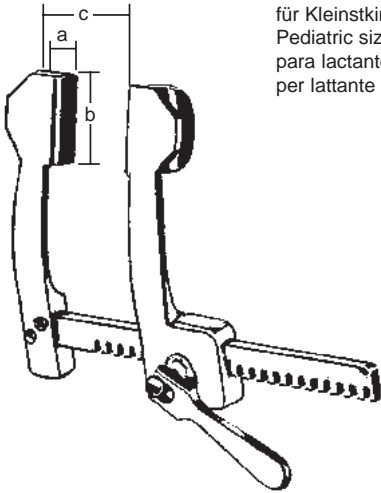

für Kleinstkinder  
 Pediatric size  
 para lactantes  
 per lattante

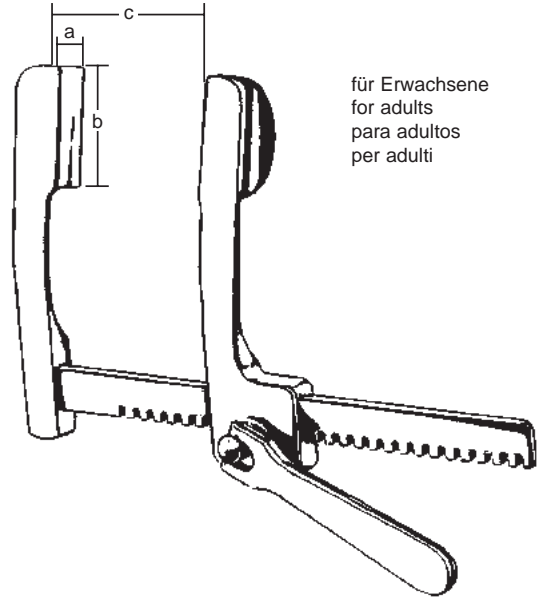

für Erwachsene  
 for adults  
 para adultos  
 per adulti

**COOLEY**

	a	b	c
	mm	mm	mm
57260-02	16	30	105
57260-03	21	44	150

**COOLEY**

	a	b	c
	mm	mm	mm
57260-04	37	49	200



**HAIGHT**

	a	b	c	h
	mm	mm	mm	mm
57260-06	30	30	90	65
57260-09	30	30	90	90



**TUFFIER**

	a	b	c
	mm	mm	mm
57264-16	50	45	165

Laminektomie-Sperrer  
Laminectomy-Retractor  
Separadores para laminectomía  
Divaricatori Laminectomia

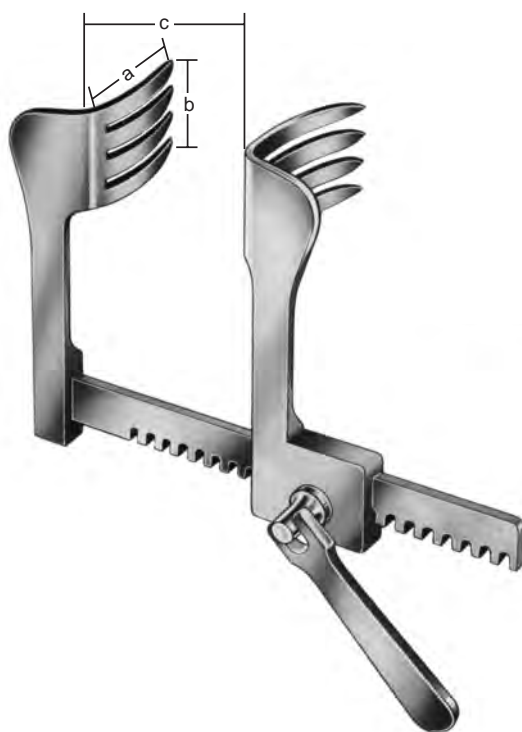

CHERRY

	a	b	c
	mm	mm	mm
57266-13	44	70	135

Thoraxsperrer, Rippenkontraktoren, Lungen spatel  
 Thoracic retractor, Rib Contractors, Lung Spatulas  
 Separador torácico, Aproximadores para costillas, Espátulas pulmonares  
 Divaricatore per il torace, Approssimatori costali, Spatole per polmone



57270-80  
 Sperrer allein  
 Retractor only  
 Separador solo  
 Divaricatore solo

MERCEDES compl.  
 57270-00

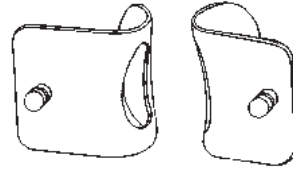

57270-65  
 42x65 mm

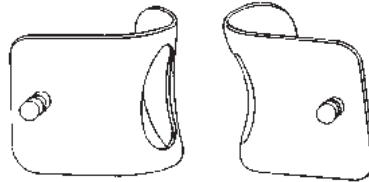

57270-75  
 75x75 mm

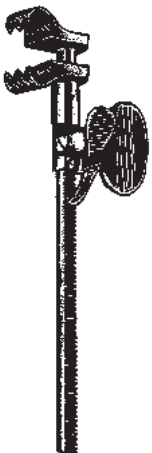

BAILEY-BABY  
 57283-14  
 14 cm, 5 1/2"



BAILEY  
 57284-16  
 16 cm, 6 1/4"



BAILEY-GIBBON  
 57286-16  
 16 cm, 6 1/4"



57288-30  
 30 cm, 11 3/4"



ALLISON  
 57289-32  
 32 cm, 12 3/4"

Lungenfaßzange, Bronchusklemmen  
 Lung Grasping Forceps, Bronchus Forceps  
 Pinzas para coger el pulmón, Pinzas clamps bronquiales  
 Pinze per afferrare il polmone, Pinze per bronchi



LOVELACE  
 57290-20  
 20 cm, 8"

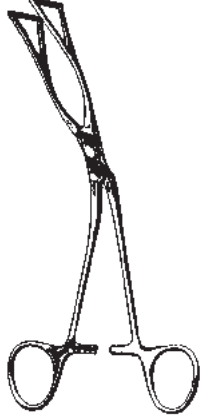

LOVELACE  
 57291-20  
 20 cm, 8"

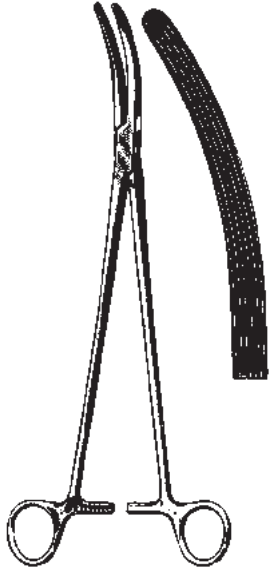

HARRINGTON  
 57301-30  
 30,5 cm, 12"

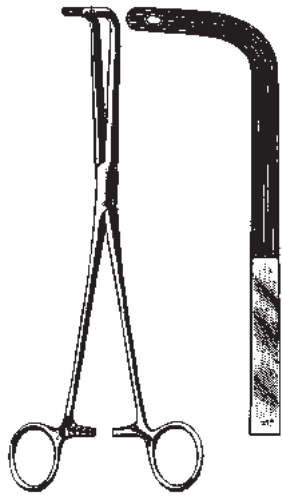

FINOCIETTO  
 57307-24  
 24 cm, 9 1/2"

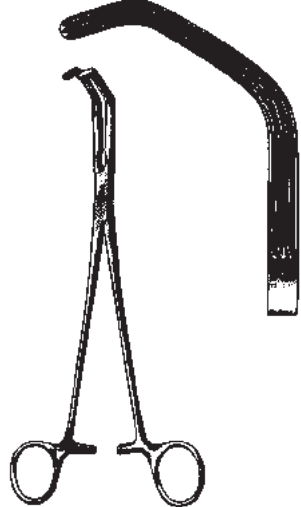

PRICE-THOMAS  
 57309-22  
 22 cm, 8 3/4"

Zähne links  
 tooth left  
 dientes izquierda  
 denti sinistro  
 57311-22



PRICE-THOMAS  
 22 cm, 8 3/4"

rechts  
 right  
 derecha  
 destro  
 57313-22

Bronchusklemmen, Gefäßklemmen  
 Bronchus Forceps, Blood Vessel Clamps  
 Pinzas clamps bronquiales, Pinzas-clamps para vasos  
 Pinze per bronchi, Pinze cardiovascolari



57321-23

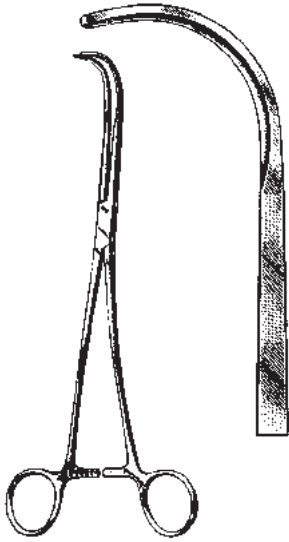

SEMB  
 23 cm, 9"

57323-23

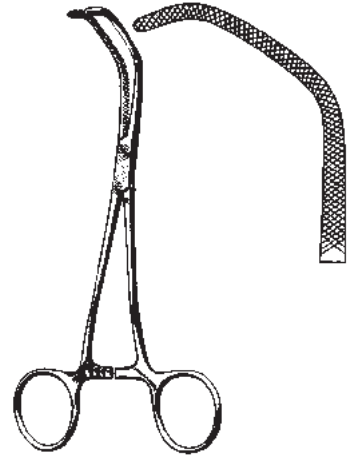

SATINSKY  
 57325-15  
 15 cm, 6"



SATINSKY  
 57327-26 - 57329-26  
 26 cm, 10 1/4"

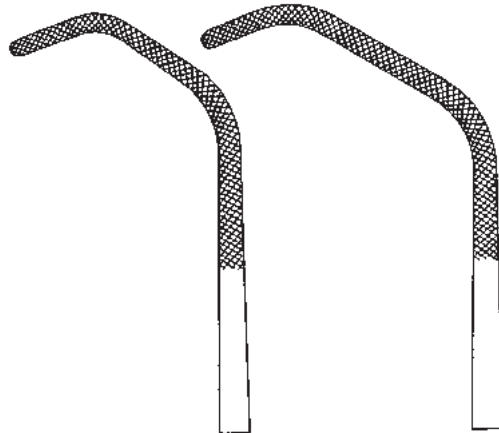

Fig. 1 57327-26

Fig. 2 57329-26



# MAST.SH-GERMANY

Coarctations-Klemmen  
 Coarctation clamps  
 Pinzas clamps para coartación  
 Pinza per coartazione

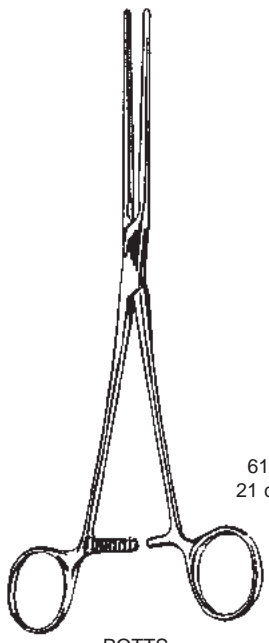

POTTS  
 61000-21 - 61000-22

61000-21  
 21 cm, 8 1/4"



61000-22  
 22 cm, 8 3/4"

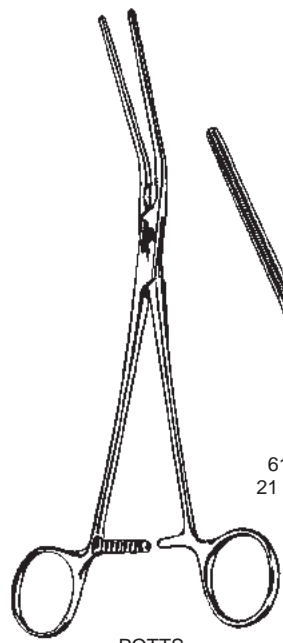

POTTS  
 61001-21 - 61001-22

61001-21  
 21 cm, 8 1/4"



61001-22  
 22 cm, 8 3/4"

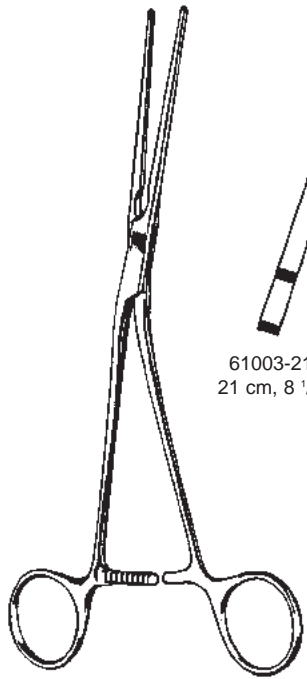

POTTS  
 61003-21 - 61003-22

61003-21  
 21 cm, 8 1/4"



61003-22  
 22 cm, 8 3/4"



Anastomosen-Klemmen, Präparier- und Ligaturklemmen  
 Anastomosis clamps, Dissecting and ligature forceps  
 Pinzas clamps para anastomosis, Pinzas para preparaciones y ligaduras  
 Pinze per anastomosi, Pinze per preparazioni e legature

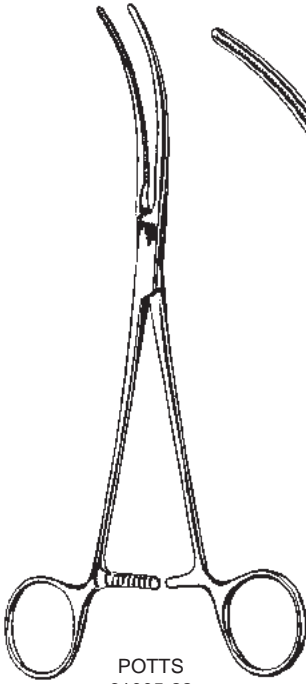

POTTS  
 61005-22  
 22 cm, 8 3/4"

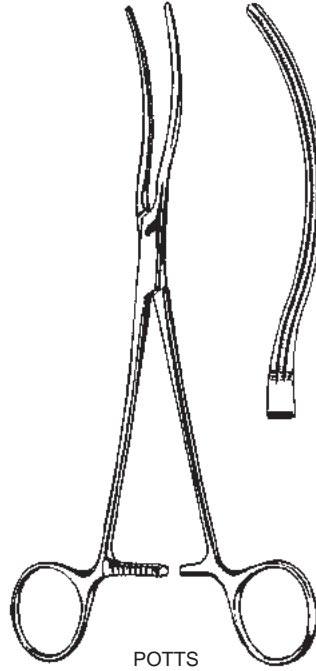

POTTS  
 61007-22  
 22 cm, 8 3/4"

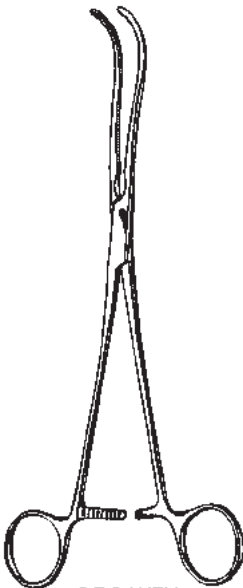

DE BAKEY61008-19 - 61008-23



61008-19  
 19 cm, 7 1/2"



61008-23  
 23 cm, 9"



# MAST.SH-GERMANY

Peripheral-Gefäßklemmen  
 Peripheral vascular clamps  
 Pinzas-clamps para vasos periféricos  
 Pinze vascolari periferici

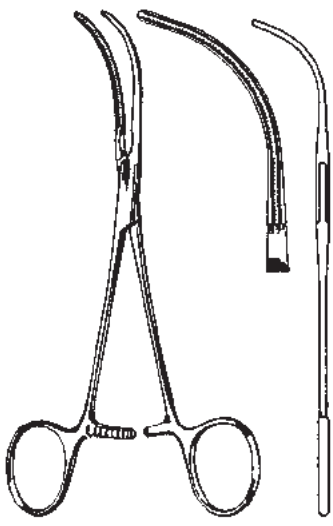

DE BAKEY  
 61009-16  
 16 cm, 6 1/4"

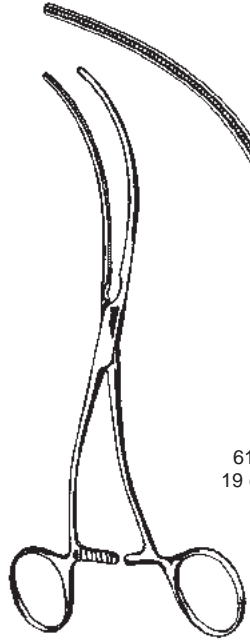

61011-19  
 19 cm, 7 1/2"

DE BAKEY  
 61011-19 - 61011-20

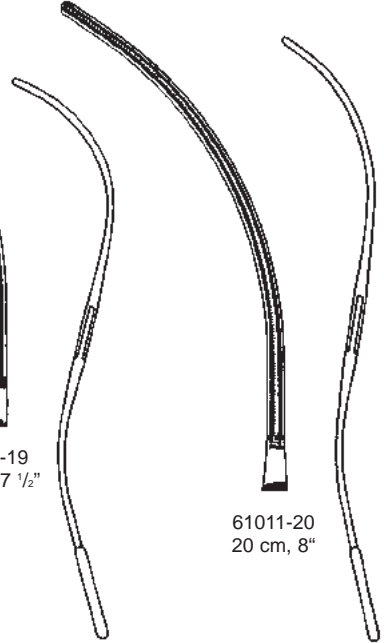

61011-20  
 20 cm, 8"

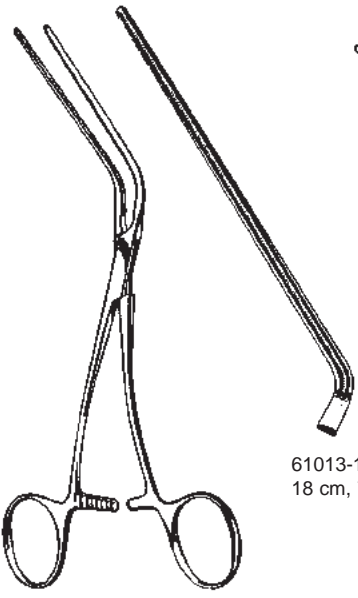

61013-18  
 18 cm, 7"

LELAND-JONES  
 61013-18 - 61013-20

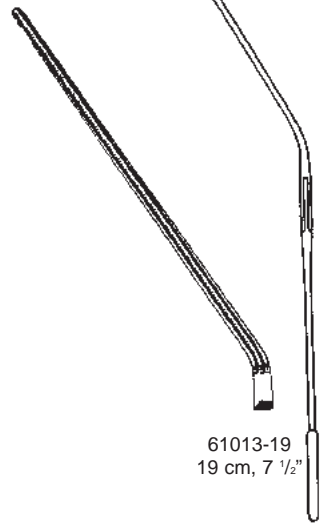

61013-19  
 19 cm, 7 1/2"

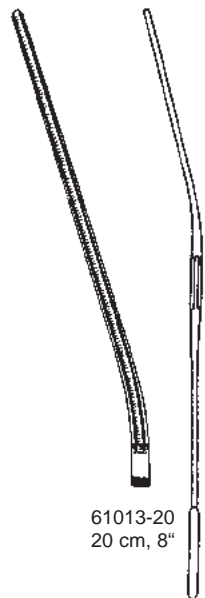

61013-20  
 20 cm, 8"





**MAST.SH-GERMANY**

Mehrzweck-Gefäßklemme  
Multi purpose Vascular Clamps  
Pinzas vasculares de usos multiples  
Pinze vascolari universali

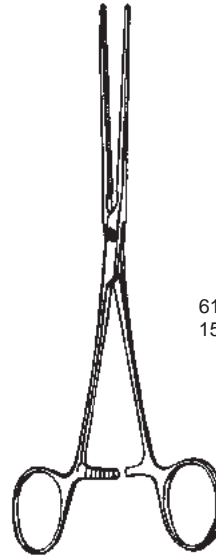

61014-15  
15 cm, 6"



61014-18  
18 cm, 7"

BAINBRIDGE  
61014-15 - 61014-18

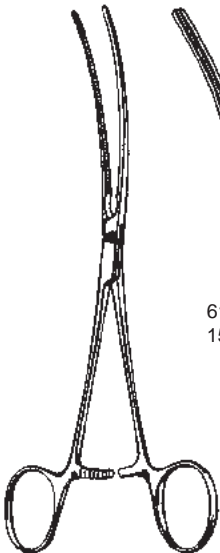

61015-15  
15 cm, 6"

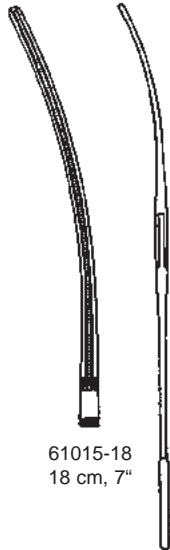

61015-18  
18 cm, 7"

BAINBRIDGE  
61015-15 - 61015-18

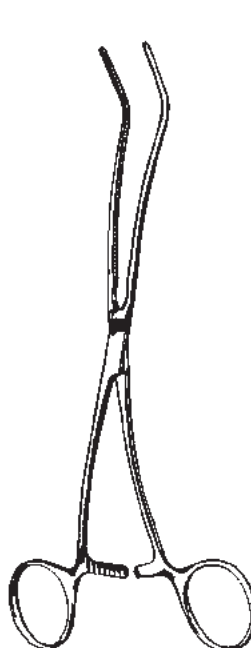

DE BAKEY  
61016-20  
20 cm, 8"





# MAST.SH-GERMANY

Aorta-Aneurysmaklemmen  
Aortic aneurysm clamps  
Pinzas-clamps para aneurisma de la aorta  
Pinze per aneurisma aorta

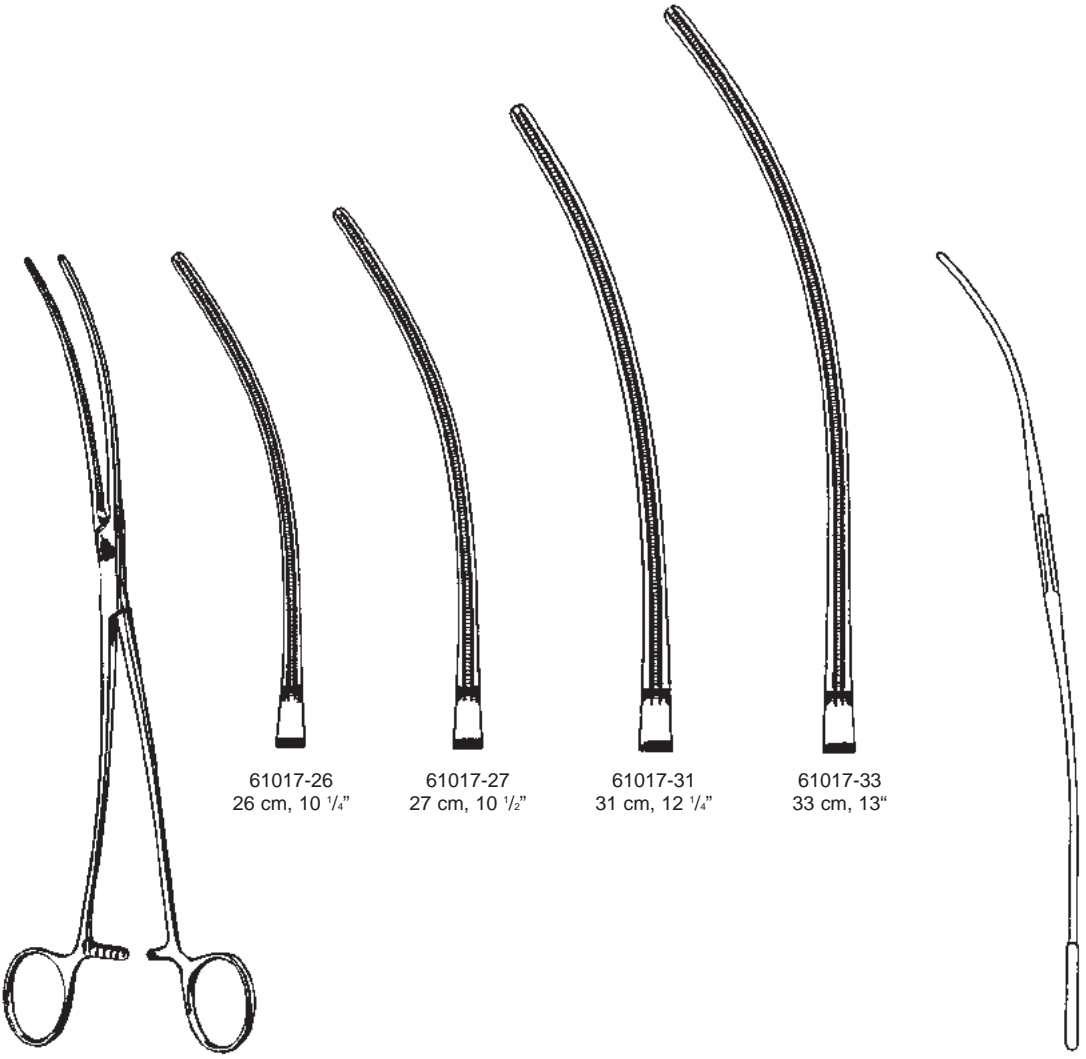

61017-26  
26 cm, 10 1/4"

61017-27  
27 cm, 10 1/2"

61017-31  
31 cm, 12 1/4"

61017-33  
33 cm, 13"

DE BAKEY  
61017-26 - 61017-33



**MAST.SH-GERMANY**

Aorta-Aneurysmaklemmen  
Aortic aneurysm clamps  
Pinzas-clamps para aneurisma de la aorta  
Pinze per aneurisma aorta



DE BAKEY  
61018-28  
28 cm, 11"



# MAST.SH-GERMANY

Aorta-Aneurysmaklemmen  
Aortic aneurysm clamps  
Pinzas-clamps para aneurisma de la aorta  
Pinze per aneurisma aorta

Draufsicht  
Top view  
Vista de arriba  
Vista da vicino

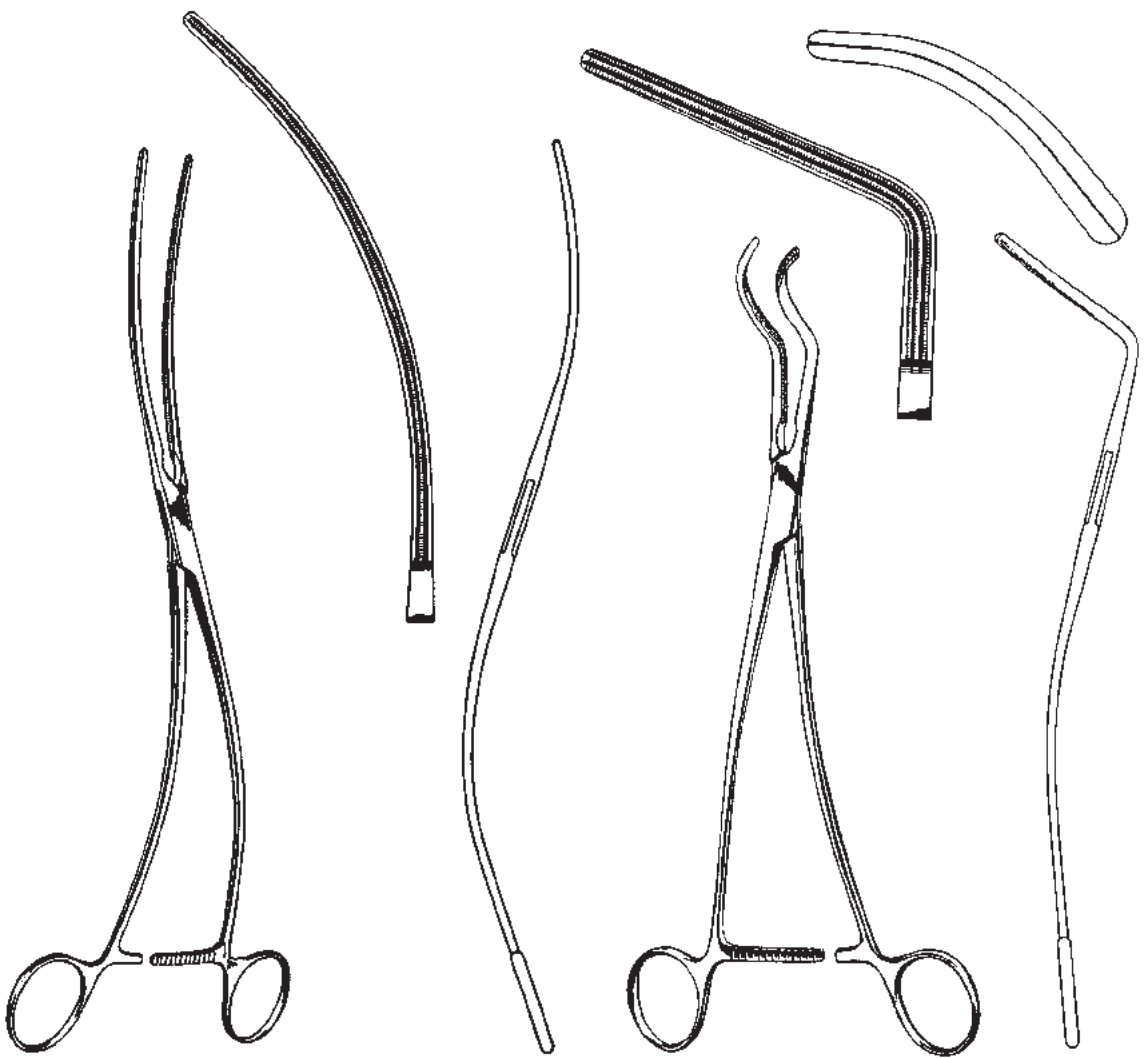

DE BAKEY  
61019-30  
30 cm, 11 3/4"

DE BAKEY  
61020-27  
27 cm, 10 1/2"



**MAST.SH-GERMANY**

Ligaturklemmen, Aortaklemme  
Ligature clamps, Aortic clamp  
Pinzas clamps para ligaduras y la aorta  
Pinze per legature e aorta

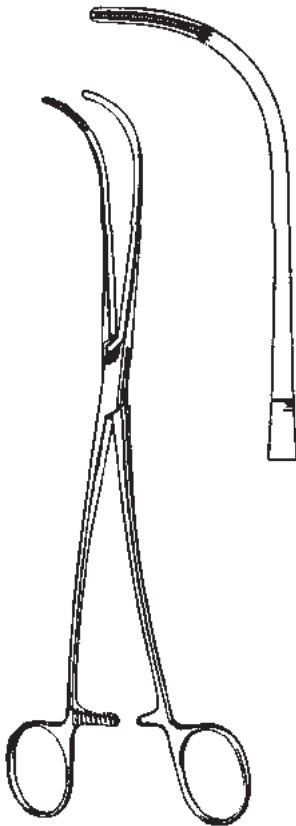

DE BAKEY-SEMB  
61021-24  
24 cm, 9 1/2"

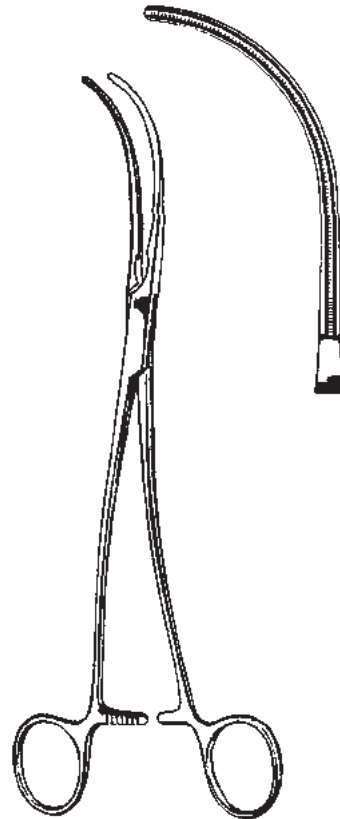

DE BAKEY  
61022-24  
24 cm, 9 1/2"



Ligaturklemme, Aortaklemme  
Ligature clamp, Aortic clamp  
Pinzas clamps para ligaduras y la aorta  
Pinze per legature e aorta

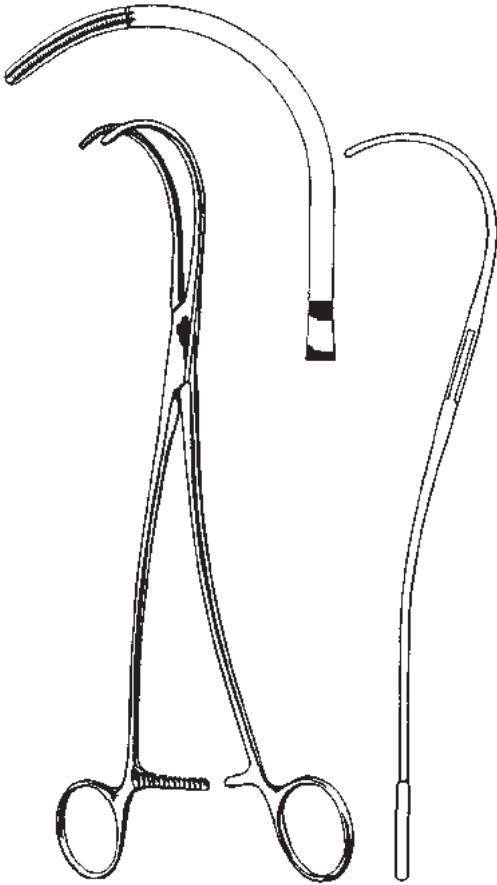

DE BAKEY  
61023-25  
25 cm, 10"

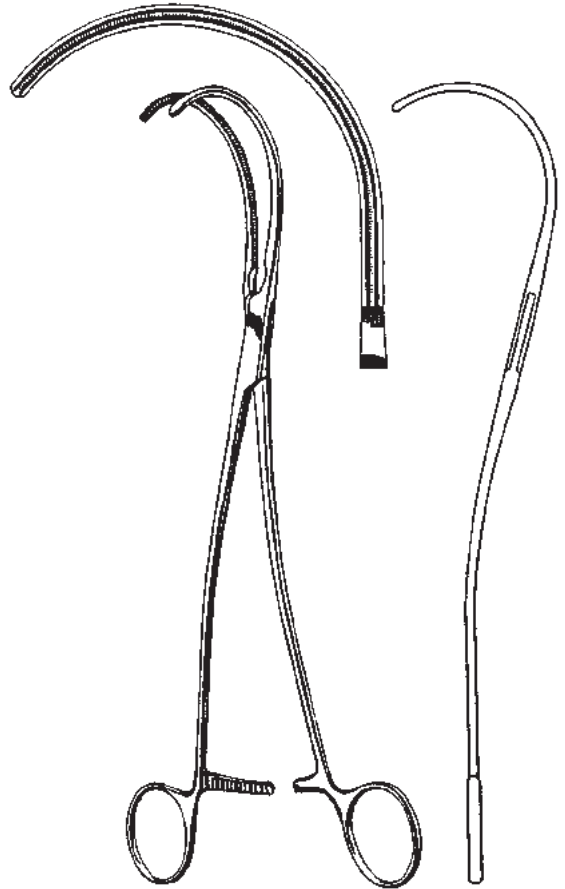

DE BAKEY  
61023-26  
26 cm, 10 1/4"

Aortaklemmen  
Aortic clamps  
Pinzas-clamps para la aorta  
Pinze per aorta

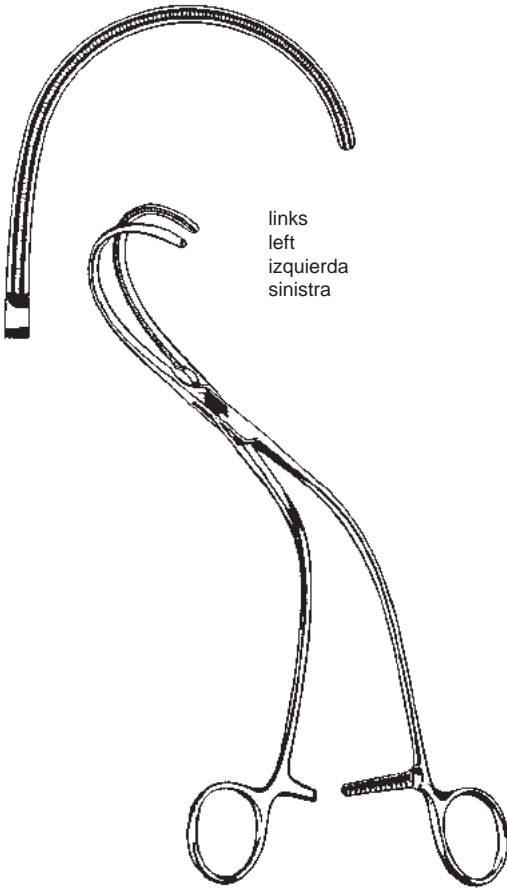

links  
left  
izquierda  
sinistra

WEBER  
61024-01  
26 cm, 10 1/4"

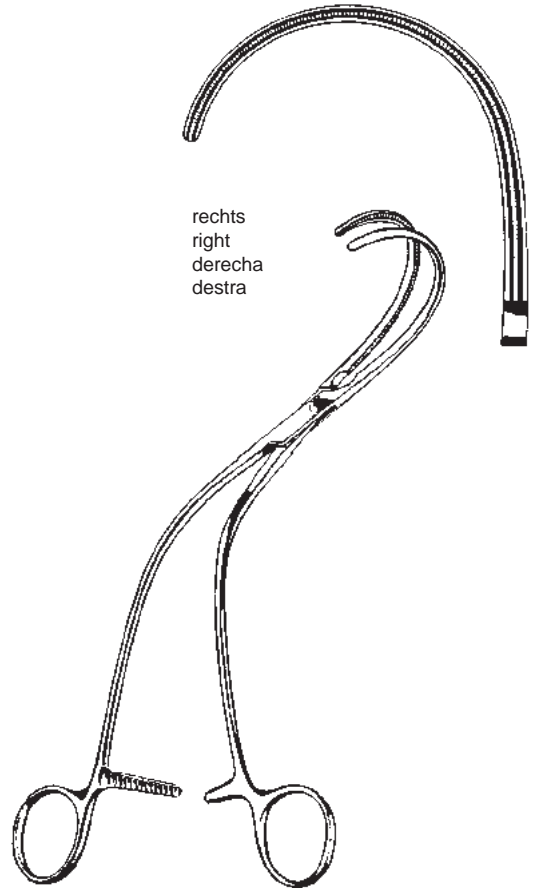

rechts  
right  
derecha  
destra

WEBER  
61024-02  
26 cm, 10 1/4"

Tangentialklemmen  
 Tangential occlusion clamps  
 Pinzas-clamps para oclusión tangencial  
 Pinze per occlusione tangenziale

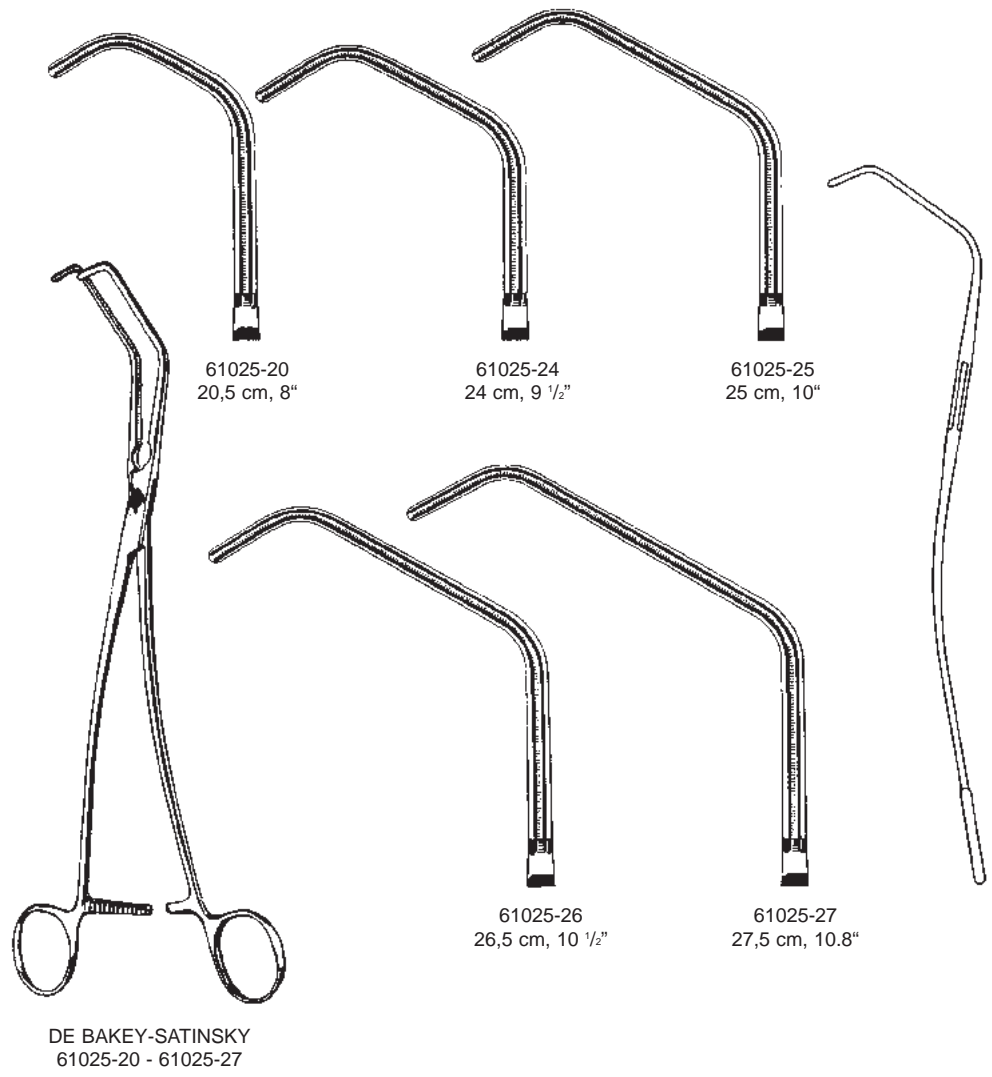



Aurikelklemmen  
 Auricle clamps  
 Pinza-clamps auriculares  
 Pinza auricula



HARKEN  
 61026-01 - 61026-04



61026-01  
 24 cm, 9 1/2"



61026-02  
 24 cm, 9 1/2"

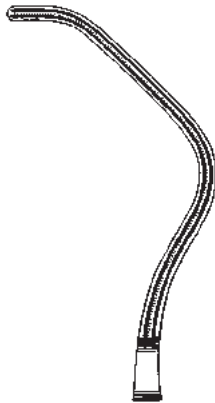

61026-03  
 24 cm, 9 1/2"



61026-04  
 24 cm, 9 1/2"

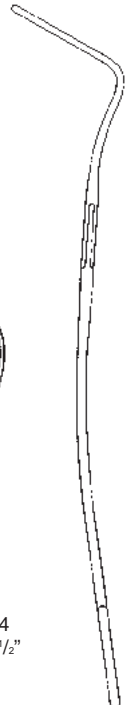

Bronchusklemmen  
Bronchus clamp  
Pinzas-clamps bronquiales  
Pinze per bronchi

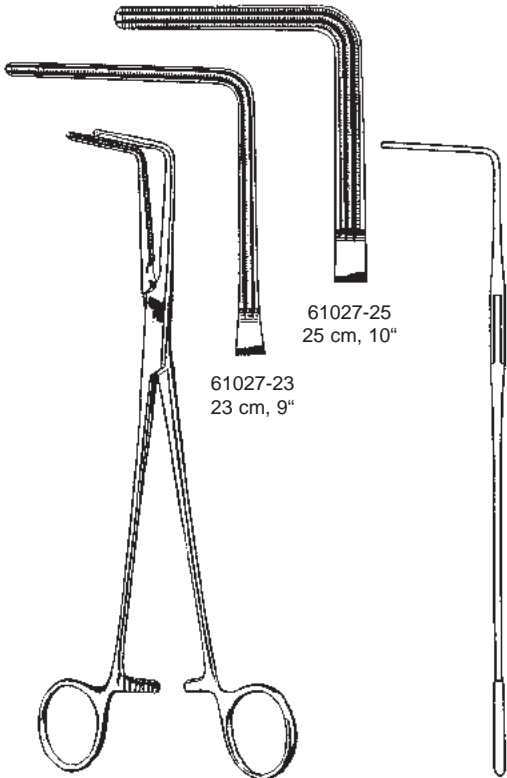

LEES  
61027-23 - 61027-25

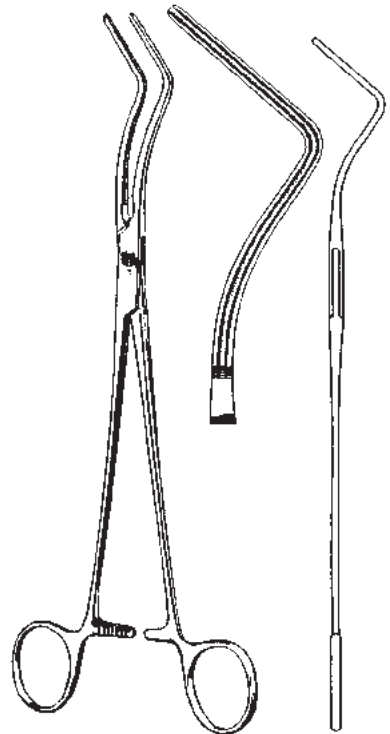

LEES  
61029-25  
25 cm, 10"



**MAST.SH-GERMANY**

Aorta-Anastomosenklemmen  
Aortic anastomosis clamps  
Pinzas-clamps para anastomosis  
Pinze anastomosi aorta

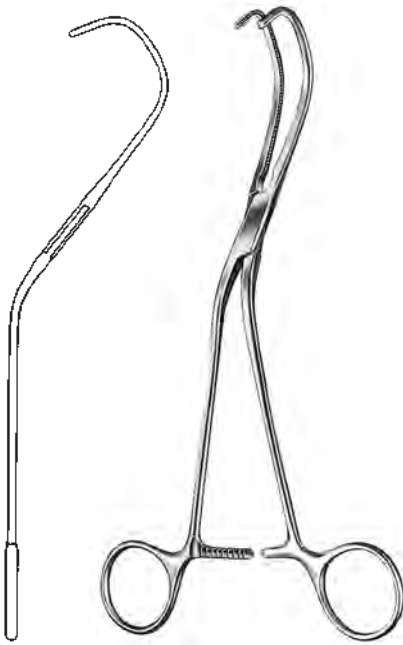

LAMBERT-KAY  
21 cm, 8 1/4"  
61030-21 - 61030-22

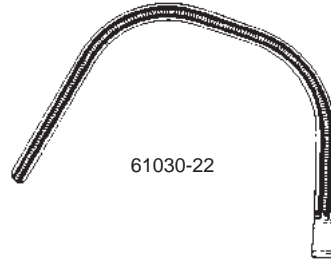

61030-22

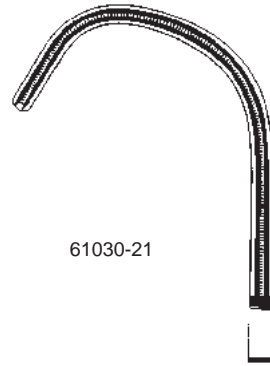

61030-21



DE BAKEY 61031-1717 cm, 6 3/4"



# MAST.SH-GERMANY

Aorta - und Aneurysmaklemme  
Aortic- and Aneurysm clamps  
Pinzas aórticas y para aneurisma  
Pinze per aorta e per aneurisma

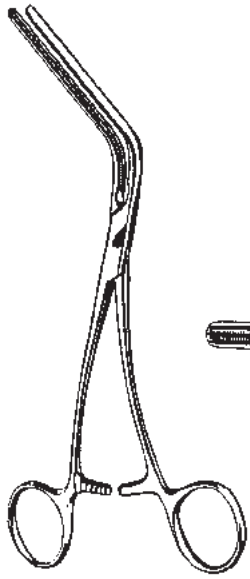

MORRIS-DE BAKEY  
61032-18 - 61032-25

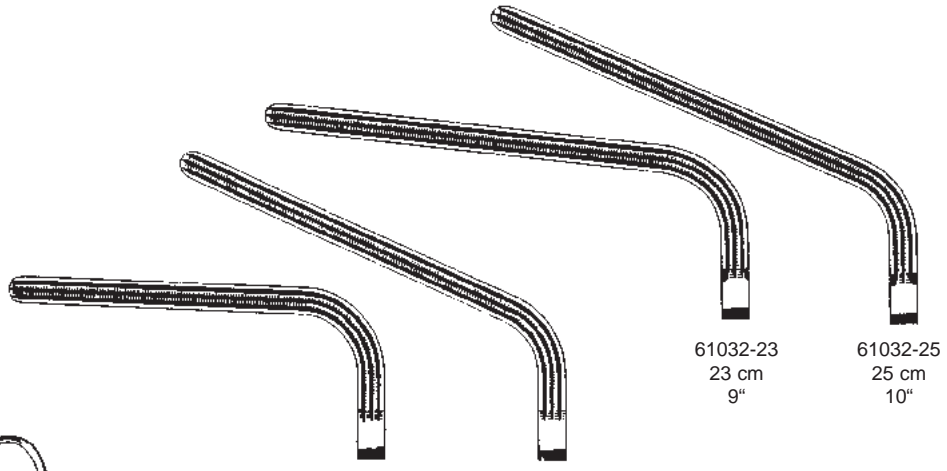

61032-18  
18 cm  
7"

61032-20  
20 cm  
8"

61032-23  
23 cm  
9"

61032-25  
25 cm  
10"

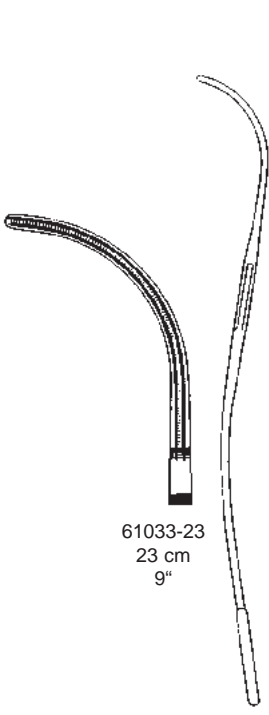

61033-23  
23 cm  
9"

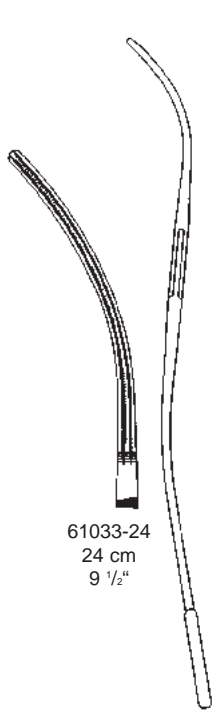

61033-24  
24 cm  
9 1/2"

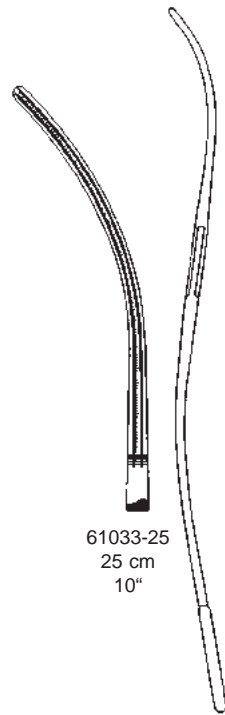

61033-25  
25 cm  
10"

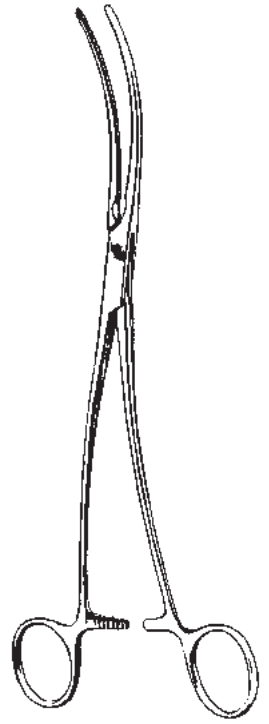

DE BAKEY-BAHNSON  
61033-23 - 61033-25

Coarctations-Klemmen  
 Coarctation clamps  
 Pinzas-clamps para coartación  
 Pinze per coartazione



DE BAKEY  
 61034-21 - 61034-31



61034-21  
 21,5 cm  
 8 1/2"



61034-23  
 23 cm  
 9"



61034-27  
 27 cm  
 10 1/2"



61034-31  
 31,5 cm  
 12 1/2"

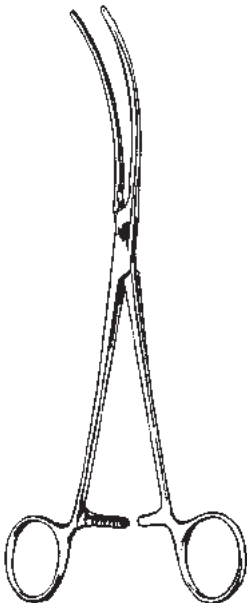

DE BAKEY  
 61035-21 - 61035-31



61035-21  
 21,5 cm  
 8 1/2"



61035-23  
 23 cm  
 9"



61035-27  
 27 cm  
 10 1/2"



61035-31  
 31 cm  
 12 1/4"



# MAST.SH-GERMANY

Mehrzweckklemmen  
 Multi purpose clamps  
 Pinzas-clamps para usos varios  
 Pinze per usi multipli

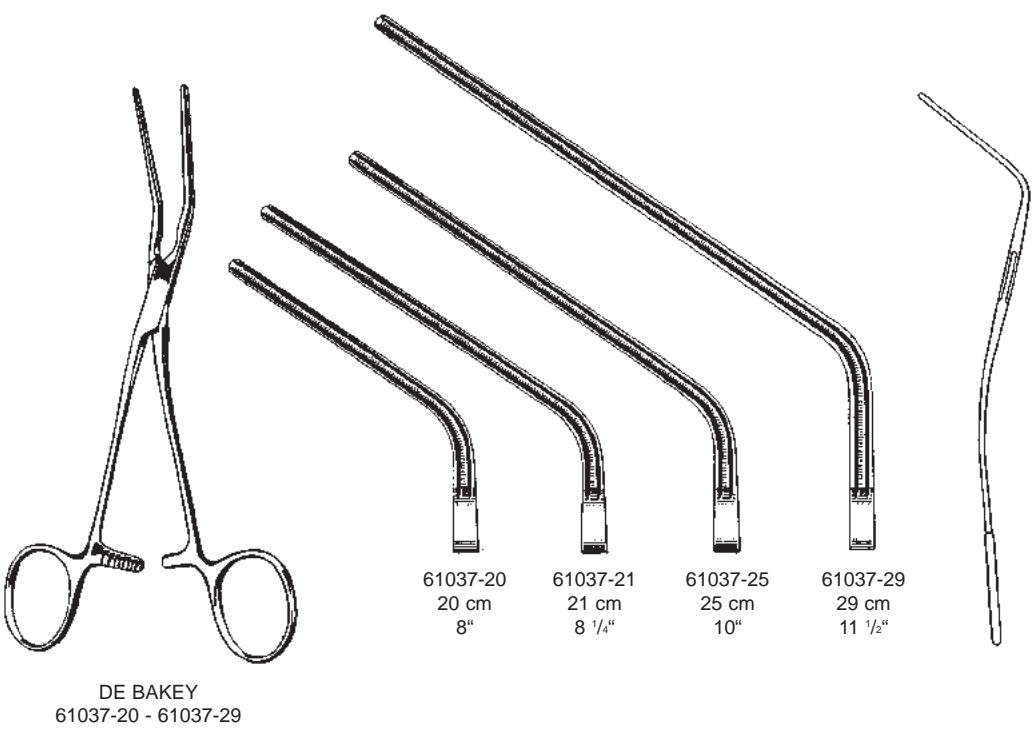
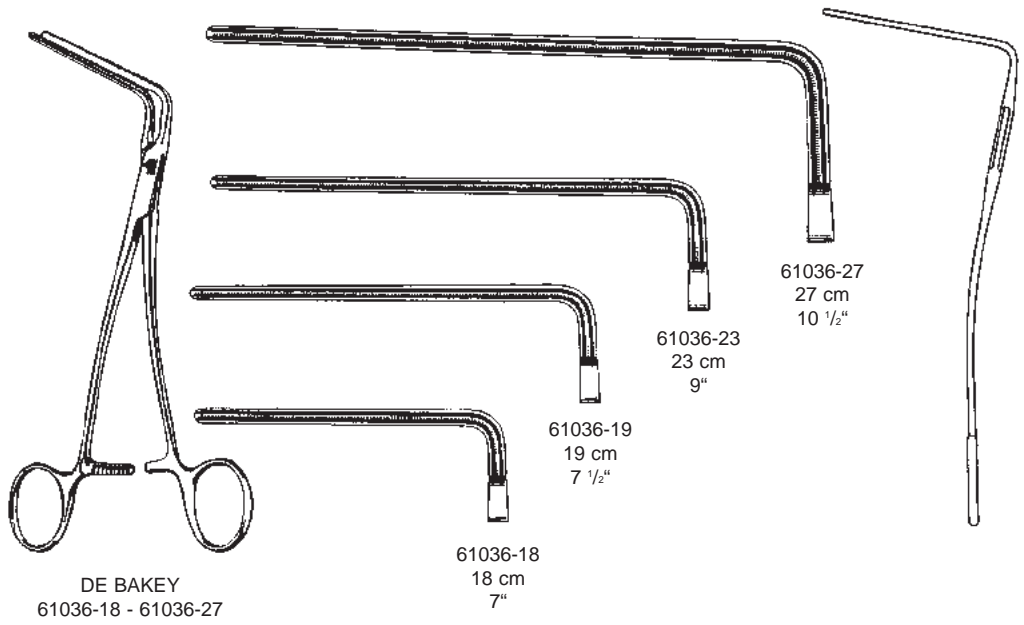



**MAST.SH-GERMANY**

Atrauma-Arterienklemmen  
Atrauma hemostatic forceps  
Pinzas hemostáticas atraumáticas  
Pinze emostatiche Atrauma

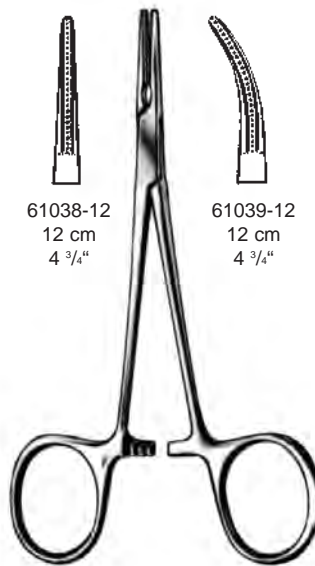

61038-12  
12 cm  
4 3/4"

61039-12  
12 cm  
4 3/4"

DE BAKEY-MOSQUITO  
61038-12 - 61039-12

Aortaklemme, Katheterklemme  
 Aortic clamps, Catheter clamps  
 Pinzas-clamps para aorta, Pinzas para catéteres  
 Pinze per aorta, Pinze per cateteri

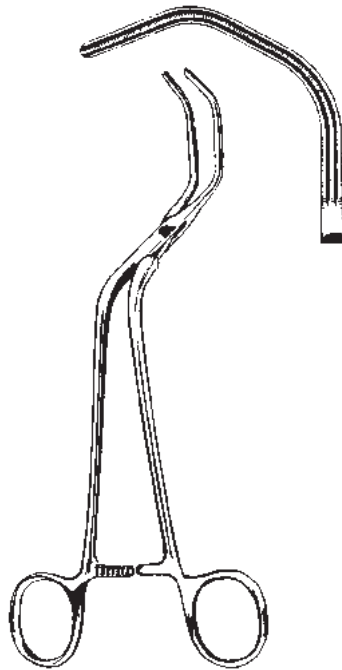

DIETRICH  
 61040-21 21 cm, 8 1/4"

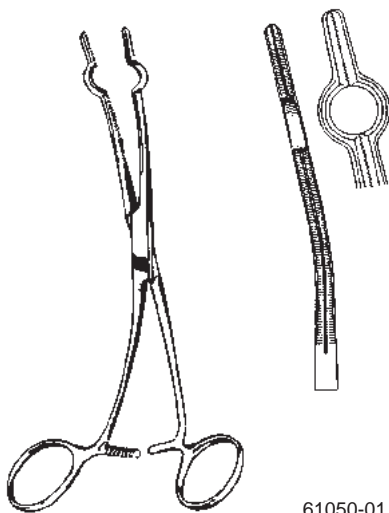

COOLEY  
 61050-01 - 61050-07

Charrière (French)	Länge Length Largo Lungo cm		
24	16	6 1/4"	61050-01
26	16	6 1/4"	61050-02
28	20	8"	61050-03
30	20	8"	61050-04
32	20	8"	61050-05
36	20	8"	61050-07

61050-01 - 61050-02  
 für Kinder  
 for children  
 para niños  
 per bambini

61050-03 - 61050-07  
 für Erwachsene  
 for adults  
 para adultos  
 per adulti





**MAST.SH-GERMANY**

Carotis-Shuntklemmen  
Carotid Shunt Clamps  
Pinzas para shunt carótido  
Pinze per carotide



JAVID  
61045-18  
17,5 cm, 6.9"



JAVID  
61046-19  
18 cm, 7"

Atrauma Cardiovascular-Klemmen  
Atrauma Cardiovascular Forceps  
Pinzas-clamps cardiovasculares  
Pinze per chirurgia vascolare

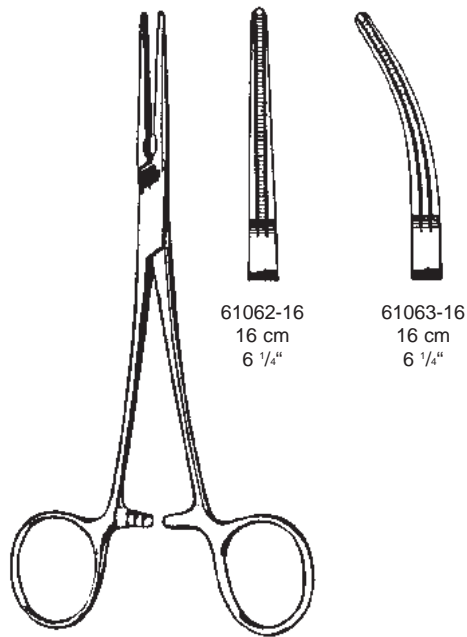

DE BAKEY-RANKIN  
61062-16 - 61063-16

Atrauma Cardiovascular-Klemmen  
 Atrauma Cardiovascular Forceps  
 Pinzas-clamps cardiovasculares  
 Pinze per chirurgia vascolare

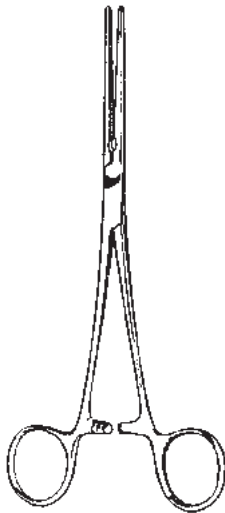

DE BAKEY-PEAN  
 61138-14 - 61138-20



61138-14  
 14 cm  
 5 1/2"



61138-16  
 16 cm  
 6 1/4"



61138-18  
 18 cm  
 7"



61138-20  
 20 cm  
 8"

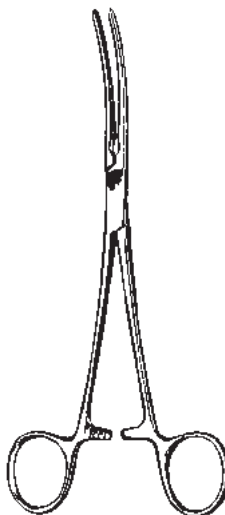

DE BAKEY-PEAN  
 61139-14 - 61139-20



61139-14  
 14 cm  
 5 1/2"



61139-16  
 16 cm  
 6 1/4"



61139-18  
 18 cm  
 7"



61139-20  
 20 cm  
 8"

Atrauma Cardiovascular-Klemmen  
 Atrauma Cardiovascular Forceps  
 Pinzas-clamps cardiovasculares  
 Pinze per chirurgia vascolare

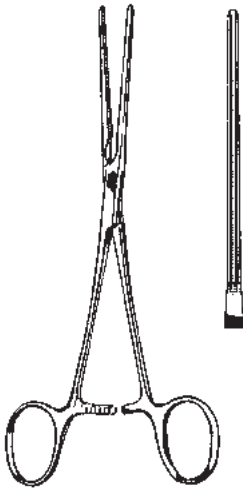

DE BAKEY  
 61140-17  
 17 cm, 6 3/4"

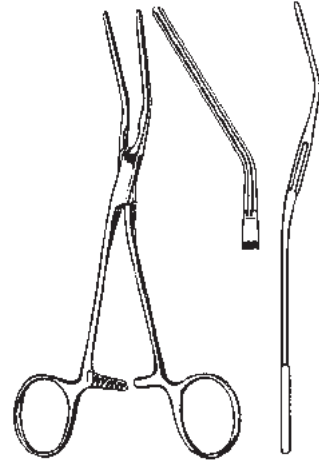

DE BAKEY  
 61141-16  
 16 cm, 6 1/4"

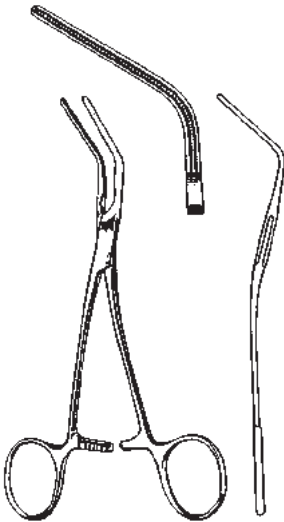

DE BAKEY  
 61143-15  
 15 cm, 6"

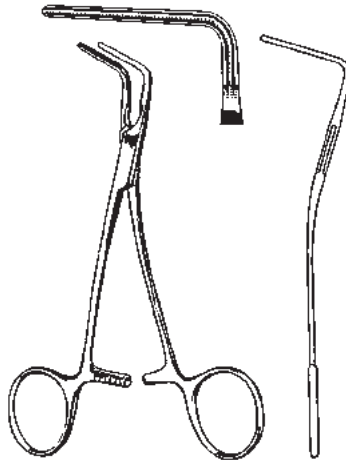

DE BAKEY  
 61145-15  
 15 cm, 6"

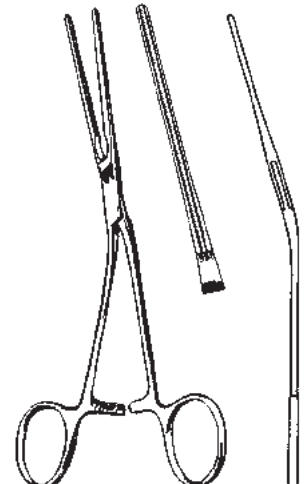

DE BAKEY  
 61147-17  
 17 cm, 6 3/4"

Atrauma Cardiovascular-Klemmen  
 Atrauma Cardiovascular Forceps  
 Pinzas-clamps cardiovasculares atraumáticas  
 Pinze cardiovascolari atraumatiche

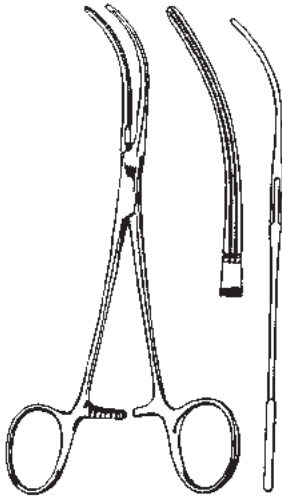

GLOVER  
 61149-17  
 17 cm, 6 3/4"

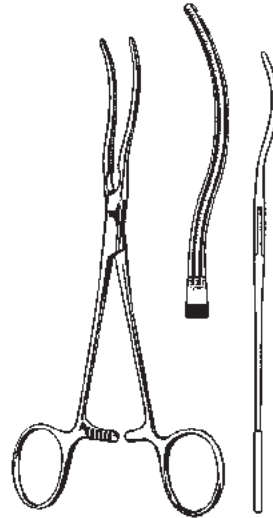

DE BAKEY  
 61151-17  
 17 cm, 6 3/4"

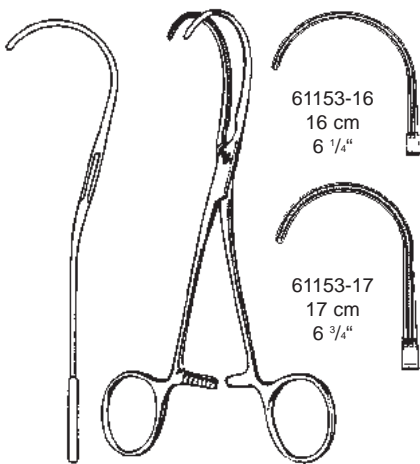

61153-16  
 16 cm  
 6 1/4"

61153-17  
 17 cm  
 6 3/4"

DE BAKEY  
 61153-16 - 61153-17

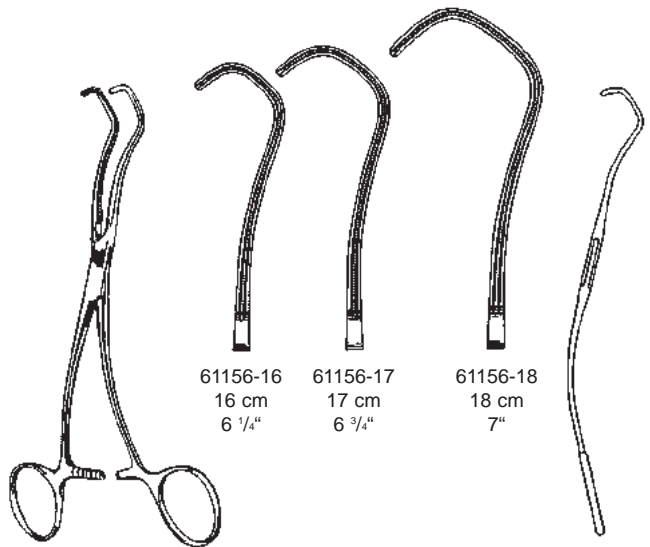

61156-16  
 16 cm  
 6 1/4"

61156-17  
 17 cm  
 6 3/4"

61156-18  
 18 cm  
 7"

DERRA  
 61156-16 - 61156-18

Atrauma Cardiovascular-Klemmen  
 Atrauma Cardiovascular Forceps  
 Pinzas-clamps cardiovasculares atraumáticas  
 Pinze atraumatiche per chirurgia vascolare

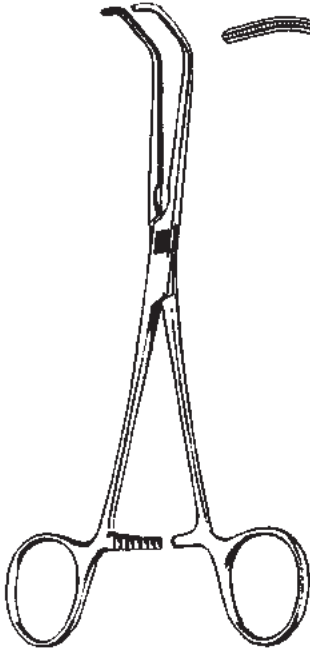

BECK  
 61157-17 17 cm, 6 <sup>3</sup>/<sub>4</sub>"

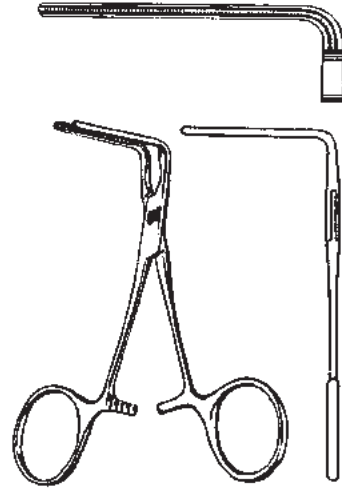

DE BAKEY  
 61158-10 10 cm, 4"

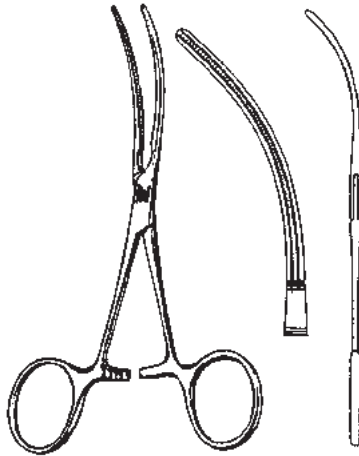

DE BAKEY

Atrauma Cardiovascular-Klemmen  
 Atrauma Cardiovascular Forceps  
 Pinzas-clamps cardiovasculares atraumáticas  
 Pinze atraumatiche per chirurgia vascolare

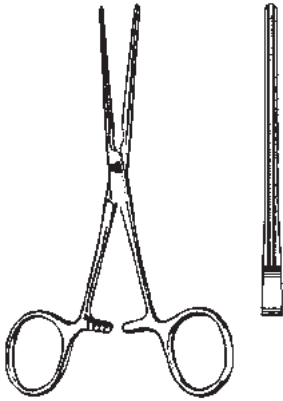

DE BAKEY  
 61158-12 12 cm, 4 3/4"

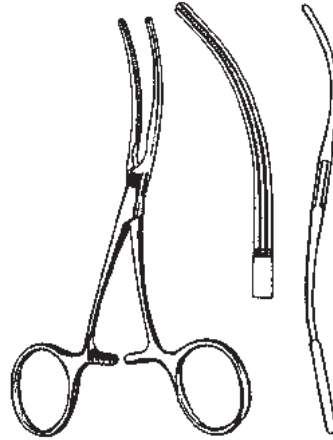

DE BAKEY  
 61159-12 11,5 cm, 4 1/2"

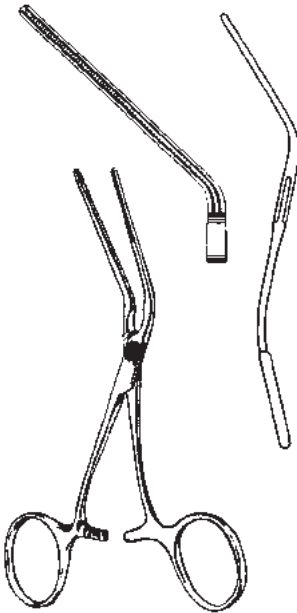

DE BAKEY  
 61159-13 13 cm, 5 1/8"

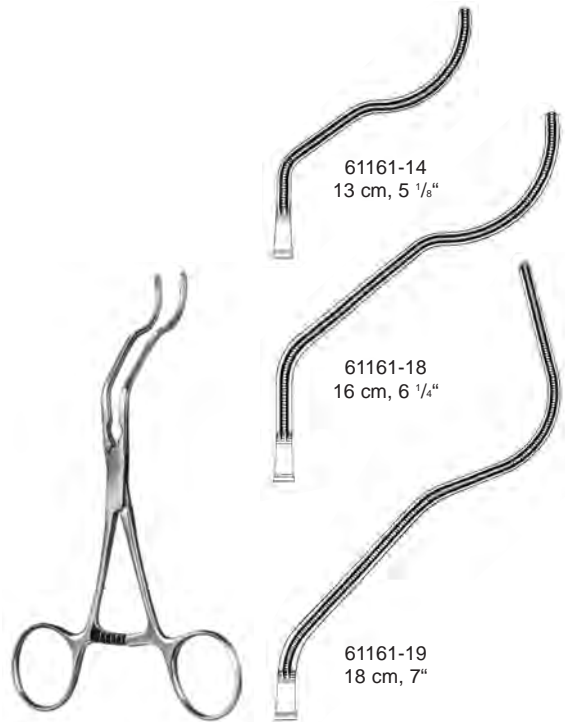

61161-14  
 13 cm, 5 1/8"

61161-18  
 16 cm, 6 1/4"

61161-19  
 18 cm, 7"

GREGORY

Atrauma Cardiovascular-Klemmen  
 Atrauma Cardiovascular Forceps  
 Pinzas-clamps cardiovasculares atraumáticas  
 Pinze atraumatiche per chirurgia vascolare

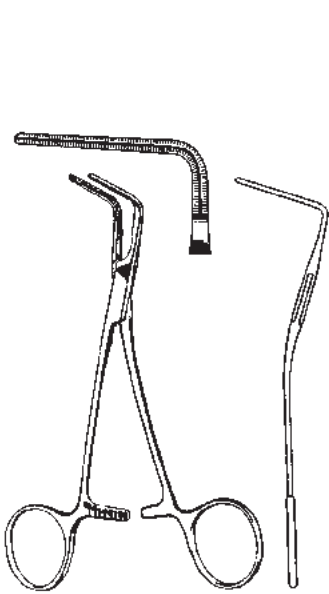

COOLEY  
 61172-15  
 15 cm, 6"

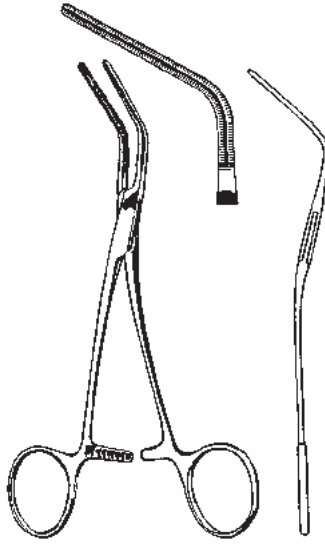

COOLEY  
 61173-16  
 15,5 cm, 6"

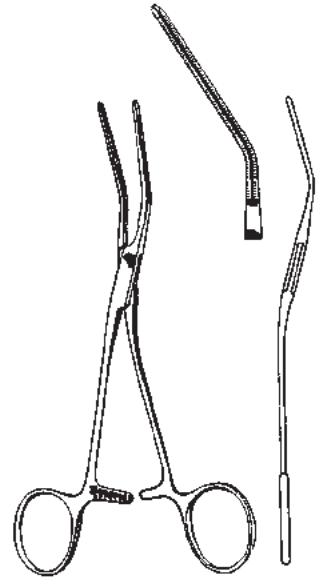

COOLEY  
 61174-17  
 17 cm, 6 3/4"

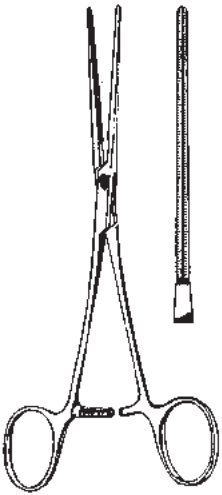

COOLEY  
 61175-17  
 17 cm, 6 3/4"

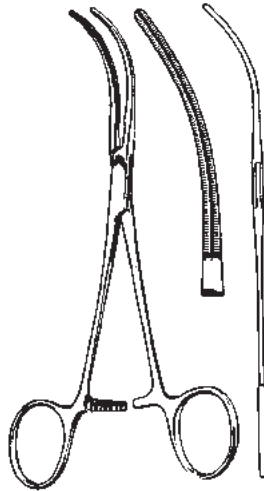

COOLEY  
 61176-17  
 17 cm, 6 3/4"

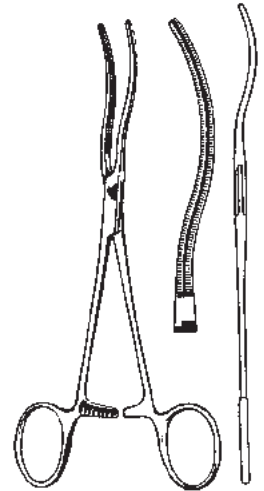

COOLEY  
 61177-17  
 17 cm, 6 3/4"



Atrauma Cardiovascular-Klemmen  
 Atrauma Cardiovascular Forceps  
 Pinzas-clamps cardiovasculares atraumáticas  
 Pinze atraumatiche per chirurgia vascolare

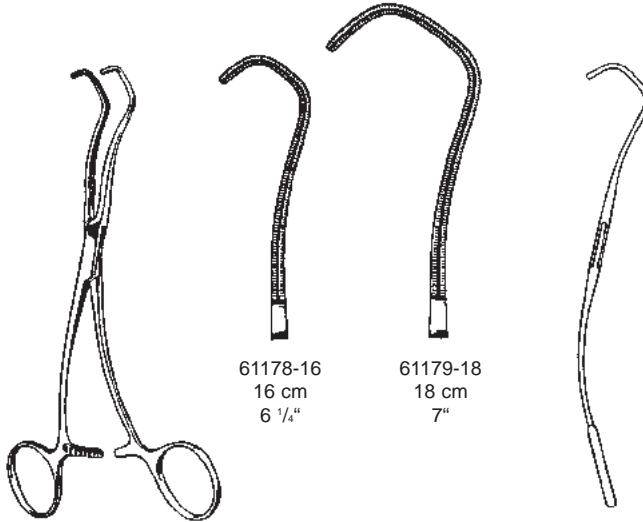

COOLEY-DERRA  
 61178-16 - 61179-18

61178-16  
 16 cm  
 6 1/4"

61179-18  
 18 cm  
 7"

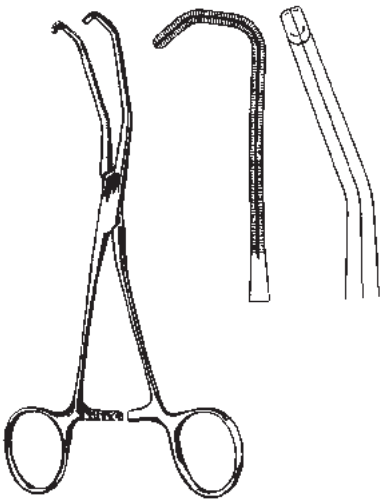

COOLEY  
 61180-17  
 17 cm, 6 3/4"

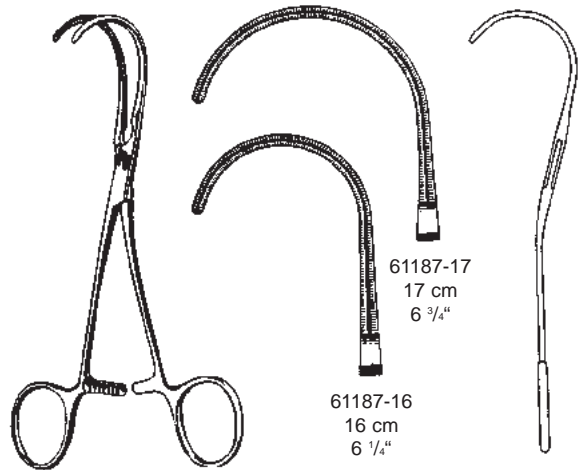

COOLEY  
 61187-16 - 61187-17

61187-17  
 17 cm  
 6 3/4"

61187-16  
 16 cm  
 6 1/4"



# MAST.SH-GERMANY

Anastomosenklemmen, Mehrzweck-Gefäßklemme  
 Anastomosis clamp, Multi purpose Vascular Clamps  
 Pinza clamp para iliac y anastomosis, Pinzas vasculares de usos multiples  
 Pinze anastomosi, Pinze vascolari universali

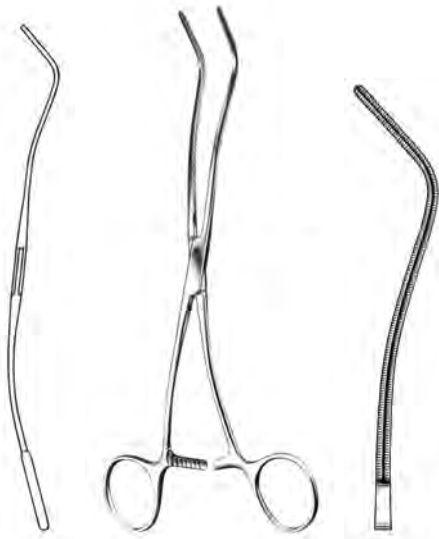

COOLEY  
 61188-20 20 cm, 8"

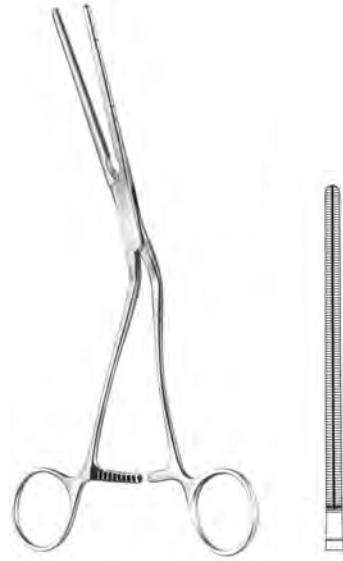

COOLEY  
 61189-21 21 cm, 8 1/4"



BECK  
 61190-17  
 17 cm, 6 3/4"

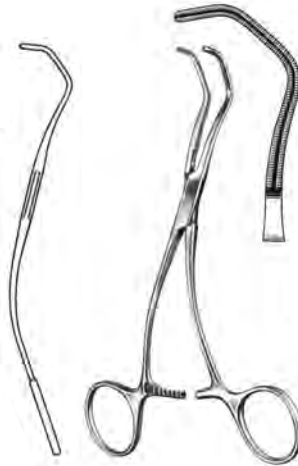

COOLEY  
 61191-16  
 16 cm, 6 1/4"



COOLEY  
 61192-17  
 17 cm, 6 3/4"

Kinder-Aortaklemme  
 Pediatric Aortic Clamps  
 Pinza aórticas pediátricas  
 Pinze per aorta pediatriche

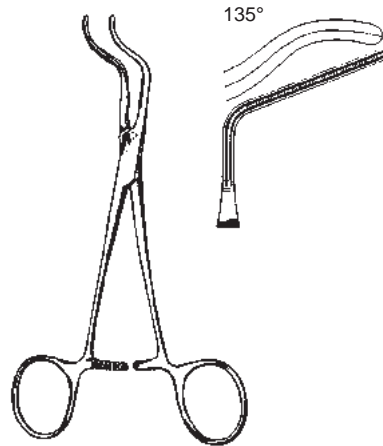

SUBRAMANIAN-MINIATURE  
 61259-15 15,5 cm, 6"

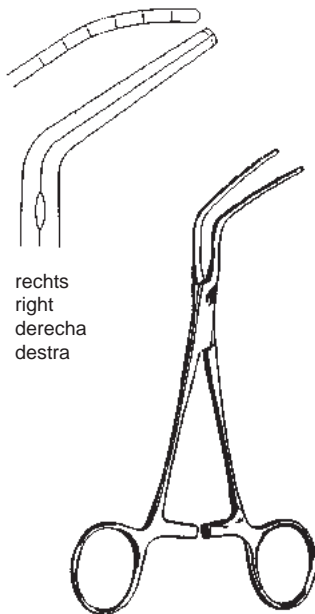

rechts  
 right  
 derecha  
 destra

SUBRAMANIAN  
 61261-16 16 cm, 6 1/4"

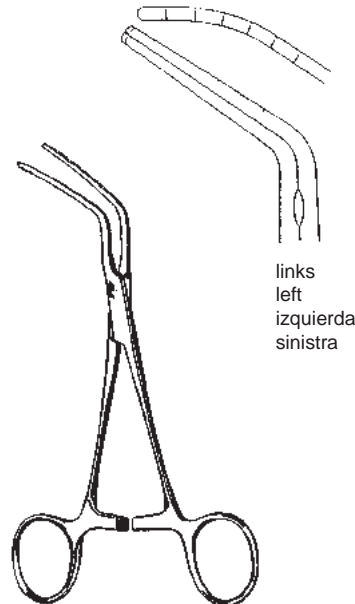

links  
 left  
 izquierda  
 sinistra

SUBRAMANIAN  
 61263-16 16 cm, 6 1/4"

Atrauma Neonatal- und Kinderklemmen, extra feine Modelle

Atrauma and Pediatric clamps, delicate Patterns

Pinzas-clamps para recién nacidos y pediátricos, modelos muy delicados, atraumáticos

Pinze Atrauma per neonati e bambini, modelli estremamente fini

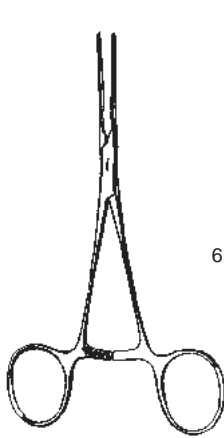

61266-01  
14 cm  
5 1/2"



61266-02  
14 cm  
5 1/2"

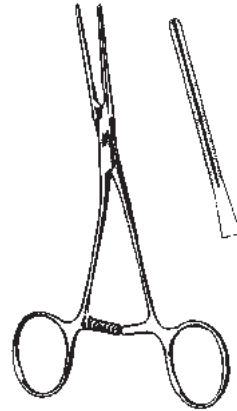

COOLEY  
61266-03 14 cm, 5 1/2"

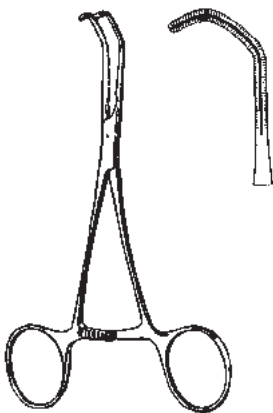

COOLEY  
61266-04 14 cm, 5 1/2"

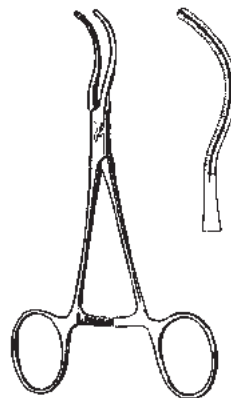

COOLEY  
61266-05 14 cm, 5 1/2"

Atrauma Neonatal- und Kinderklemmen  
 Neonatal and Pediatric Clamps  
 Pinzas-clamps pediátricas y para recién-nacidos, atraumáticas  
 Pinze per neonati e bambini

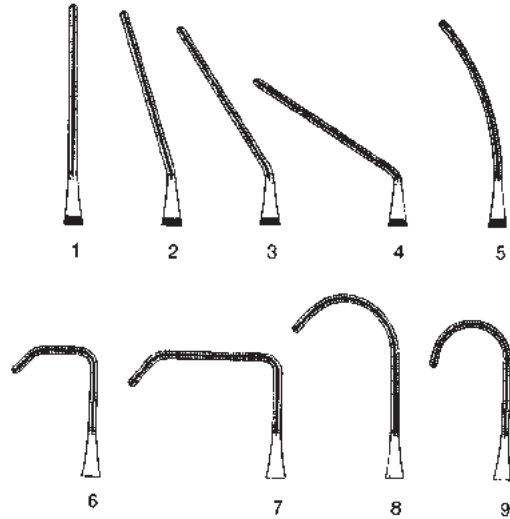
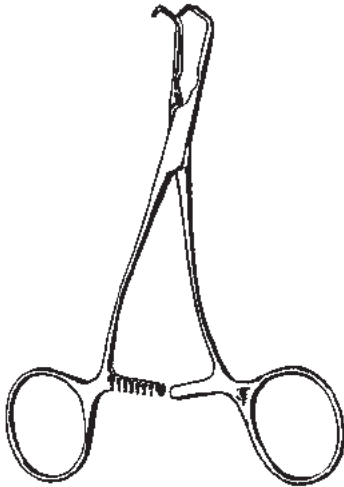



Fig.	gerade straight rectas rette	
1	61372-01 14 cm, 5 1/2"	
2	61372-02 14 cm, 5 1/2"	
3	61372-03 14 cm, 5 1/2"	
4	61372-04 13 cm, 5 1/8"	
5	61372-05 14 cm, 5 1/2"	
6	61372-06 13 cm, 5 1/8"	
7	61372-07 13 cm, 5 1/8"	
8	61372-08 14 cm, 5 1/2"	
9	61372-09 13,5 cm, 5 1/4"	



Fig.	stark abgewinkelt strongly angled ramas anguladas forte angolata	
1	61373-01 14 cm, 5 1/2"	
2	61373-02 14 cm, 5 1/2"	
3	61373-03 14 cm, 5 1/2"	
4	61373-04 13 cm, 5 1/8"	
5	61373-05 14 cm, 5 1/2"	
6	61373-06 13 cm, 5 1/8"	
7	61373-07 13 cm, 5 1/8"	
8	61373-08 14 cm, 5 1/2"	
9	61373-09 13,5 cm, 5 1/4"	

Fig.	abgewinkelt angled acodadas angolate	
1	61374-01 14 cm, 5 1/2"	
2	61374-02 14 cm, 5 1/2"	
3	61374-03 14 cm, 5 1/2"	
4	61374-04 13 cm, 5 1/8"	
5	61374-05 14 cm, 5 1/2"	
6	61374-06 13 cm, 5 1/8"	
7	61374-07 13 cm, 5 1/8"	
8	61374-08 14 cm, 5 1/2"	
9	61374-09 13,5 cm, 5 1/4"	

Clipanlagezangen für die offene Chirurgie 25° aufgebogen  
 Clip Appliers for open Surgery 25° upcurved  
 Pinza aplicadora de clips para cirugía abierta con ángulo de 25°  
 Pinza applicatore clips per chirurgia aperto, curvo in alto 25°



15 cm, 6"

**Horizon**

61460-15 Small gelb / yellow / jaune/ amarillo/ giallo  
 61461-15 Medium blau / blue / bleu / azul / blu

**SLS Clips**

61464-15 Micro weiss / white / blanc / blanco / bianco  
 61465-15 Small gelb / yellow / jaune/ amarillo/ giallo  
 61466-15 Small medium lila / lilac / lilas / lila / lilla  
 61467-15 Medium blau / blue / bleu / azul / blu

**Ethicon**

61470-15 Small blau / blue / bleu / azul / blu  
 61471-15 Medium weiss / white / blanc / blanco / bianco

**Pilling**

61481-15 Small gelb / yellow / jaune / amarillo / giallo  
 61482-15 Medium blau / blue / bleu / azul / blu

**Horizon**

61460-19 Small gelb / yellow / jaune / amarillo / giallo  
 61461-19 Medium blau / blue / bleu / azul / blu  
 61462-19 Medium Large grün / green / verde / verde  
 61463-19 Large orange / naranja / arancione

**SLS Clips**

61464-19 Micro weiss / white / blanc / blanco / bianco  
 61465-19 Small gelb / yellow/ jaune / amarillo / giallo  
 61466-19 Small medium lila / lilac / lilas / lila / lilla  
 61467-19 Medium blau / blue / bleu / azul / blu  
 61468-19 Medium Large grün / green / verde / verde  
 61469-19 Large orange / naranja / arancione

**Ethicon**

61470-19 Small blau / blue / bleu / azul / blu  
 61471-19 Medium weiss / white / blanc / blanco / bianco  
 61472-19 Medium Large grün / green / verde / verde  
 61473-19 Large gelb / yellow / jaune / amarillo / giallo

**Pilling**

61481-19 Small gelb / yellow / jaune / amarillo / giallo  
 61482-19 Medium blau / blue / bleu / azul / blu  
 61484-19 Medium Large grün / green / verde / verde  
 61483-19 Large orange / naranja / arancione



19 cm, 7 1/2"



Clipanlegezangen für die offene Chirurgie 25° aufgebogen  
Clip Appliers for open Surgery 25° upcurved  
Pinza aplicadora de clips para cirugía abierta con ángulo de 25°  
Pinza applicatore clips per chirurgia aperto, curvo in alto 25°

**Horizon**

61461-28 Medium blau / blue / bleu / azul / blu  
61462-28 Medium Large grün / green / verde / verde  
61463-28 Large orange / naranja / arancione

**SLS Clips**

61464-28 Micro weiss / white / blanco / bianco  
61465-28 Small gelb / yellow / jaune / amarillo / giallo  
61466-28 Small medium lila / lilac / lilas / lila / lilla  
61467-28 Medium blau / blue / bleu / azul / blu  
61468-28 Medium Large grün / green / verde / verde  
61469-28 Large orange / naranja / arancione

**Ethicon**

61471-28 Medium weiss / white / blanco / bianco  
61472-28 Medium Large grün / green / verde / verde  
61473-28 Large gelb / yellow / jaune / amarillo / giallo

**Pilling**

61482-28 Medium blau / blue / bleu / azul / blu  
61484-28 Medium Large grün / green / verde / verde  
61483-28 Large orange / naranja / arancione



28 cm, 11"

Atrauma Cardiovascular-Klemmen, extra feine Modelle  
 Atrauma Cardiovascular Forceps, extra delicate Patterns  
 Pinzas-clamps cardiovasculares, modelos muy delicados, atraumáticos  
 Pinze atraumatiche per chirurgia vascolare, modelli delicati

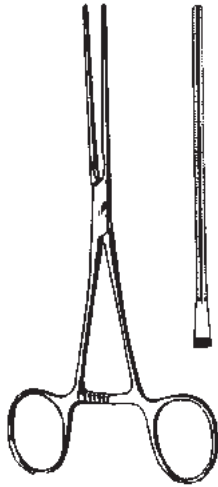

61488-16  
 16,5 cm, 6 1/2"



61489-16  
 16 cm, 6 1/4"

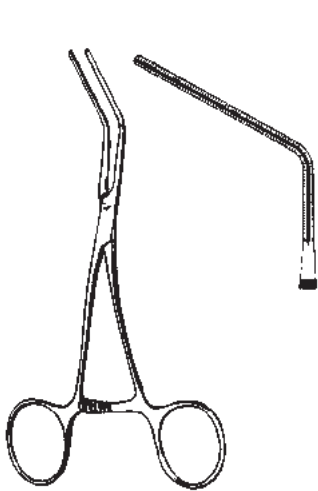

61490-15  
 15 cm, 6"

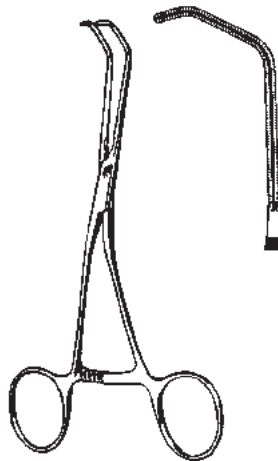

61491-15  
 15 cm, 6"

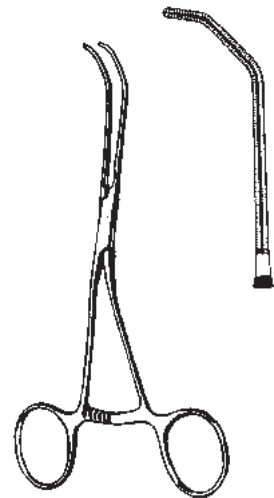

61492-16  
 15,5 cm, 6"





**MAST.SH-GERMANY**

Neonatal-Klemmen  
Neonatal-Clamps  
Pinzas-clamps para recién-nacidos  
Pinze per neonati

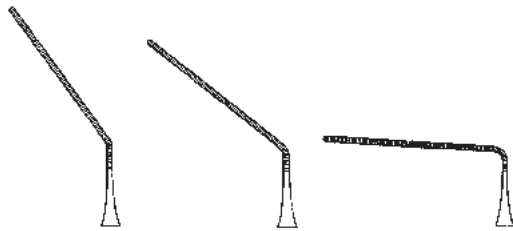

61493-01  
13 cm  
5 1/8"

61493-02  
13 cm  
5 1/8"

61493-03  
11 cm  
4 3/8"

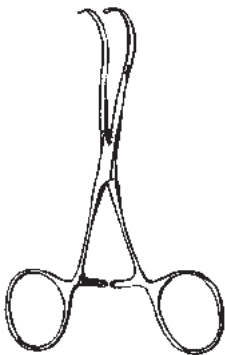

CASTANEDA  
61493-01 - 61495-04



61495-01  
12 cm  
4 3/4"



61495-02  
12 cm  
4 3/4"



61495-03  
12 cm  
4 3/4"



61495-04  
12 cm  
4 3/4"



# MAST.SH-GERMANY

Aorta Dilatoren, Tourniquets  
 Aortic Dilators, Tourniquets  
 Diladores de aorta, Tourniquets  
 Dilatori vascolari, Tornichetti

Spreizweite von 8 - 42 mm  
 Blade opening from 8 to 42 mm  
 Abertura de 8 a 42 mm  
 Apertura da 8 a 42 mm

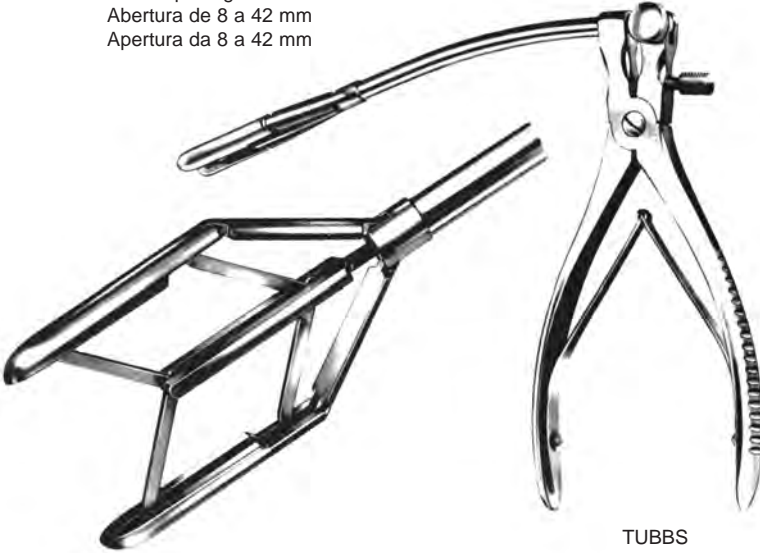

TUBBS  
61500-00

Spreizweite von 8 - 15 mm  
 Blade opening from 8 to 15 mm  
 Abertura de 8 a 15 mm  
 Apertura da 8 a 15 mm



COOLEY  
61506-00



RUMEL-BELMONT  
 61700-33 3,2 mm Ø  
 61710-33 6,4 mm Ø  
 33 cm, 13"  
 flexibel, flexible,  
 flexible, flessibile

61700-01  
 61710-01  
 Mandrin alleine  
 Guide only  
 Guida sola



**MAST.SH-GERMANY**

Gefäß-Dilatatoren  
Vascular Dilators  
Dilatadores vasculares  
Dilatatori vascolari

biegsam  
malleable  
maleables  
malleabili

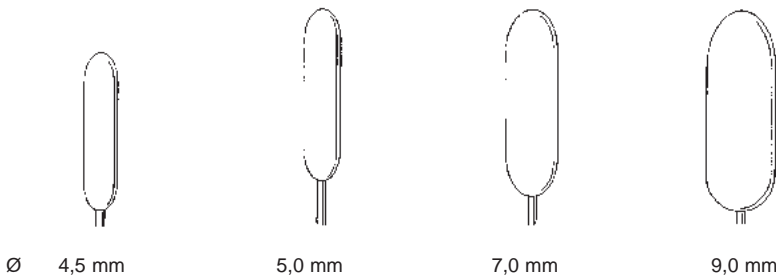
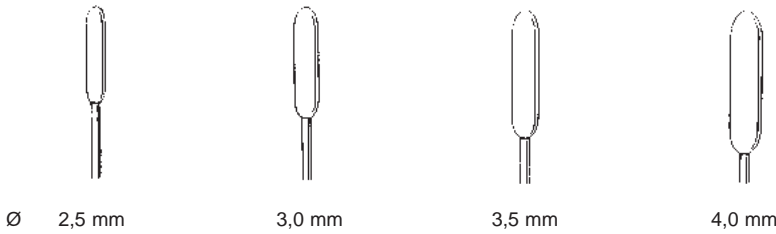
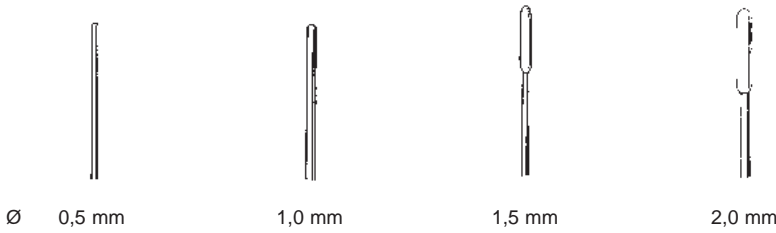

DE BAKEY

19 cm, 7 1/2"	Ø mm	35 cm, 13 3/4"
61810-05	0,5	61820-05
61810-10	1,0	61820-10
61810-15	1,5	61820-15
61810-20	2,0	61820-20
61810-25	2,5	61820-25
61810-30	3,0	61820-30
61810-35	3,5	61820-35
61810-40	4,0	61820-40
61810-45	4,5	61820-45
61810-50	5,0	61820-50
61810-70	7,0	61820-70
61810-90	9,0	61820-90

Spatel, Gefäßdissektoren  
 Spatula, vascular Dissectors  
 Espátulas, Disecadores vasculares  
 Spatola, Dissettori vascolari

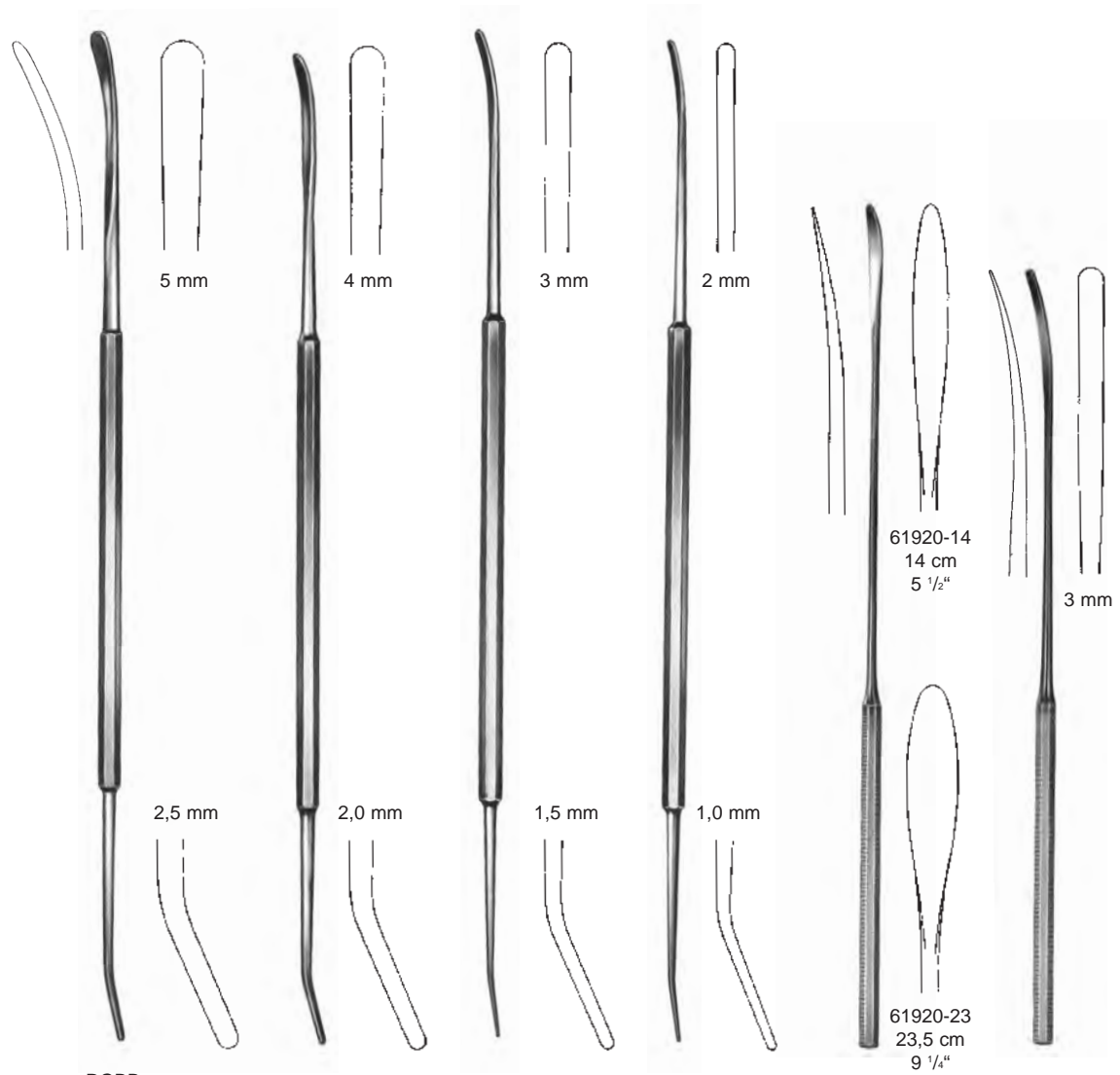

ROBB  
 24 cm  
 9 1/2"

Fig. 1  
 61910-01

Fig. 2  
 61910-02

Fig. 3  
 61910-03

Fig. 4  
 61910-04

stumpf  
 blunt  
 roma  
 smussa

61930-18  
 18,5 cm, 7 1/4"

61930-21  
 21,5 cm, 8 1/2"

stumpf  
 blunt  
 roma  
 smussa

Gallensteinzangen  
 Gall Stone Forceps  
 Pinzas para cálculos biliares  
 Pinze per calcoli biliari



Fig. 1  
 63101-23



Fig. 2  
 63103-23

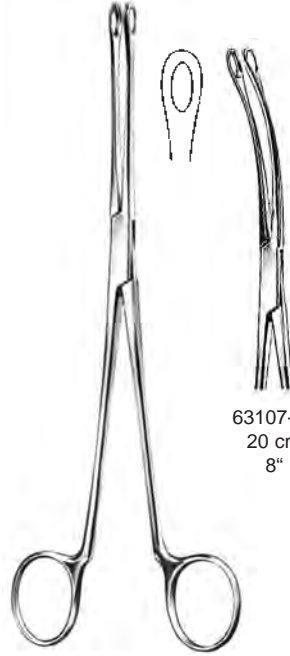

63107-20  
 20 cm  
 8"

DESJARDINS  
 23 cm, 9"

BLAKE  
 63106-20 20 cm, 8"



MAYO-BLAKE  
 63110-20 20 cm, 8"



MAYO-BLAKE  
 63111-20 20 cm, 8"



MIXTER  
 63117-22 22 cm, 8 3/4"



# MAST.SH-GERMANY

Gallensteinsonden, Gallengangdilatoren

Gall Stone Probes, Bile duct dilators

Exploradores para cálculos biliares, Dilatadores para conductos biliares

Sonde per calcoli biliari, Dilatatori per condotti biliari

Ø 5,8 cm



Gallensteiniöffel  
Gall Stone Scoops  
Cucharillas para cálculos biliares  
Cucchiai per calcoli biliari

MOOR  
63125-28  
28 cm, 11"

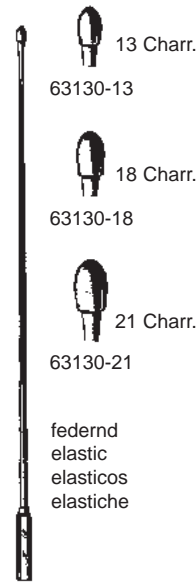

13 Charr.  
63130-13  
18 Charr.  
63130-18  
21 Charr.  
63130-21

federnd  
elastic  
elásticos  
elastiche

DESJARDINS  
63130-13 - 63130-21  
28 cm, 11"



MOYNIHAN  
63142-34 34 cm, 13 1/2"



Ø mm 1 63150-01 2 -02 3 -03 4 -04 5 -05 6 -06 7 -07

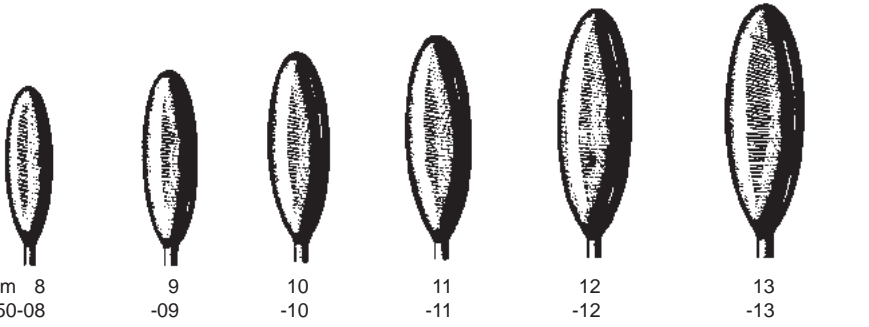

Ø mm 8 63150-08 9 -09 10 -10 11 -11 12 -12 13 -13

biegsam  
malleable  
maleable  
malleabili

BAKES  
63150-01 - 63150-13  
30 cm, 11 3/4"

63150-00 = Satz à 9 St. / set of 9 size 3 to 11  
juego de 9 fig. 3-11 / serie di 9 pezzi



Gallensteinlöffel  
Gall Stone Scoops  
Cucharillas para cálculos biliares  
Cucchiai per calcoli biliari

biegsam  
malleable  
maleables  
malleabili

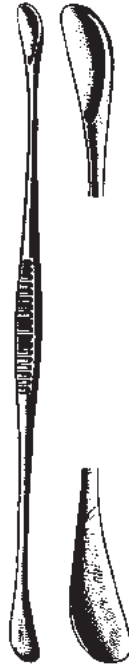
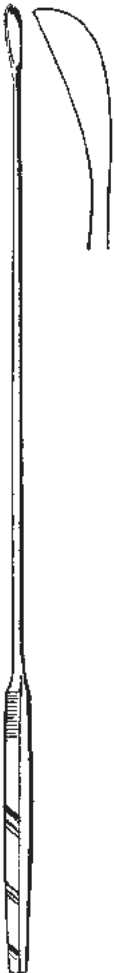

**FERGUSSON**  
63170-21 - 63170-23

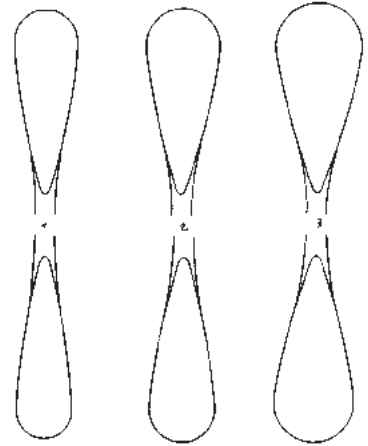

63170-21  
21,5 cm  
8 1/2"

63170-22  
22 cm  
8 3/4"

63170-23  
23,5 cm  
9 1/4"



2,5 mm

Fig. 000  
63173-01



3,2 mm

Fig. 00  
63173-02

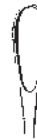

3,6 mm

Fig. 0  
63173-03



5,5 mm

Fig. 1  
63173-04



6,7 mm

Fig. 2  
63173-05



8,0 mm

Fig. 3  
63173-06



11 mm

Fig. 4  
63173-07



15 mm

Fig. 5  
63173-08

LUER-KOERTE 63173-01 - 63173-08 32 cm, 12 3/4"



# MAST.SH-GERMANY

Gallensteinlöffel  
Gall Stone Scoops  
Cucharillas para cálculos biliares  
Cucchiai per calcoli biliari



MAYO  
63175-27  
27 cm, 10 1/2"

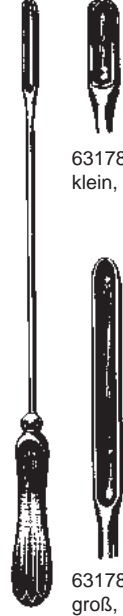

63178-01  
Klein, small, pequeña, piccola

63178-03  
groß, large, grande

MAYO  
63178-01 - 63178-03  
27 cm, 10 1/2"

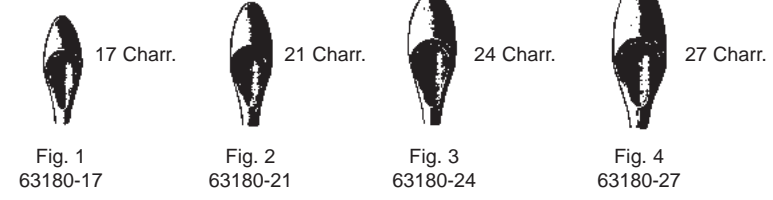

Fig. 1  
63180-17

Fig. 2  
63180-21

Fig. 3  
63180-24

Fig. 4  
63180-27

federnd  
elastic  
elásticas  
elastiche

DESJARDINS  
63180-17 - 63180-27  
30 cm, 11 3/4"



MAYO  
63210-32  
32 cm, 12 3/4"





Nierensteinzange, Nierenfistelzange  
Kidney Stone Forceps, Nephrostomy Forceps  
Pinzas para cálculos renales, Pinza para nefrostomía  
Pinze per calcoli renali, Pinze per nefrostomia



**RANDALL**

- Fig. 1 63231-01 23 cm, 9"
- Fig. 2 63231-02 22 cm, 8 3/4"
- Fig. 3 63231-03 22 cm, 8 3/4"
- Fig. 4 63231-04 22 cm, 8 3/4"
- Fig. 5 63231-05 19 cm, 7 1/2"
- Fig. 6 63231-06 19 cm, 7 1/2"

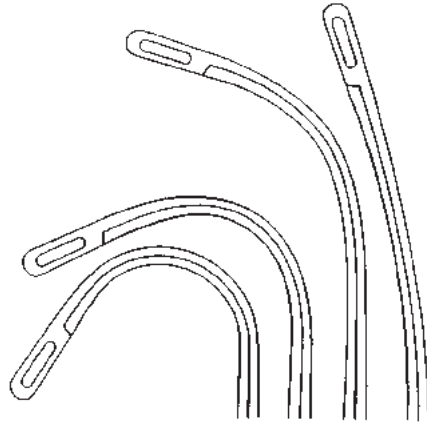

Fig. 4 Fig. 3 Fig. 2 Fig. 1

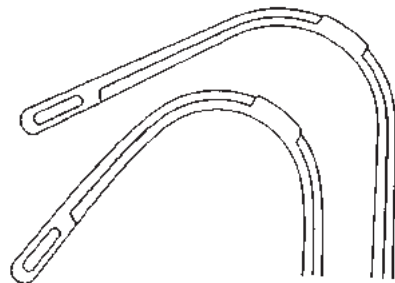

Fig. 6 Fig. 5



# MAST.SH-GERMANY

Nierensteinzange  
Kidney Stone Forceps  
Pinzas para cálculos renales  
Pinze per calcoli renali



HEIMING

für Kinder  
for children  
para niños  
per bambini



63232-01  
17 cm, 6 3/4"



63232-02  
16 cm, 6 1/4"



Darm-Organfaßzangen  
Bowel and Tissue Grasping Forceps  
Pinzas para coger intestinos y tejidos  
Pinze per afferrare intestini e tessuti

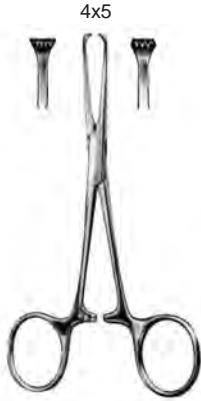

**ALLIS-BABY**  
65102-12 12 cm, 4 3/4"  
65102-14 14 cm, 5 1/2"

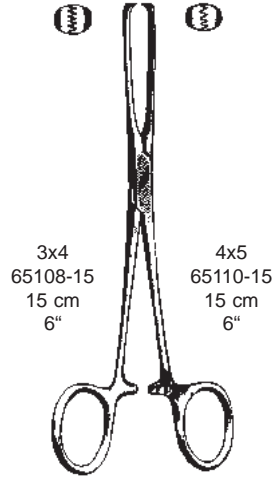

**ALLIS**

3x4		4x5
65108-15		65110-15
15 cm		15 cm
6"		6"
15 cm	6"	65120-15
19 cm	7 1/2"	65120-19
22 cm	8 3/4"	65120-22
24 cm	9 1/2"	65120-24



atrauma  
atraumatic  
atraumática  
atraumatica

**ALLIS**  
65124-16 16 cm, 6 1/4"  
65124-20 20 cm, 8"  
65124-22 22 cm, 8 3/4"  
65124-25 25 cm, 10"  
65124-30 30 cm, 11 3/4"

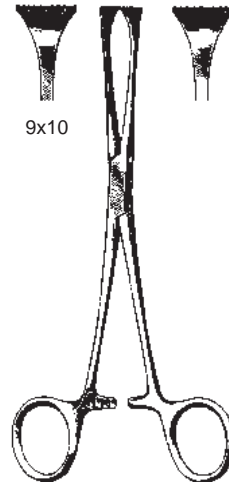

**ALLIS-ADAIR**  
65130-15  
15,5 cm, 6"



# MAST.SH-GERMANY

Darm-Organfaßzangen  
Bowel and Tissue Grasping Forceps  
Pinzas para coger intestinos y tejidos  
Pinze per afferrare intestini e tessuti

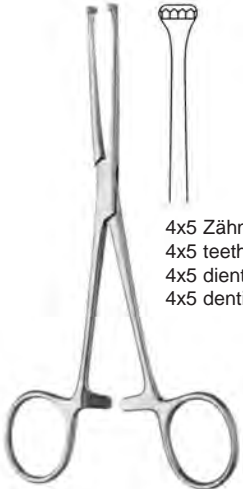

4x5 Zähne  
4x5 teeth  
4x5 dientes  
4x5 denti

LOCKWOOD-ALLIS  
65132-16 16 cm, 6 1/4"  
65132-20 20 cm, 8"

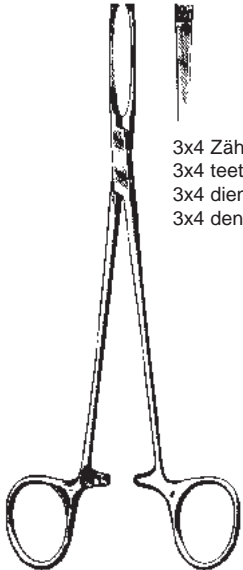

3x4 Zähne  
3x4 teeth  
3x4 dientes  
3x4 denti

JUDD-ALLIS  
65140-15 15 cm, 6"  
65140-19 19 cm, 7 1/2"



5x6 Zähne  
5x6 teeth  
5x6 dientes  
5x6 denti

BOYS-ALLIS  
65145-15 15 cm, 6"

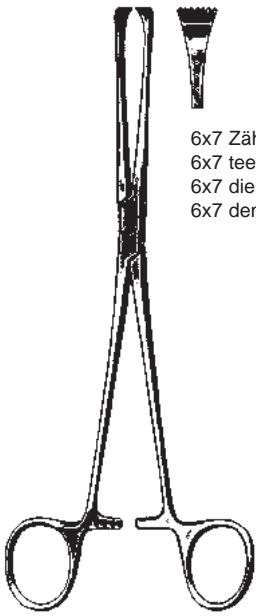

6x7 Zähne  
6x7 teeth  
6x7 dientes  
6x7 denti

THOMS-ALLIS  
65150-20 20 cm, 8"



2x3 Zähne  
2x3 teeth  
2x3 dientes  
2x3 denti

LITTLEWOOD  
65154-18 18,5 cm, 7 1/4"

Darmfaßzangen  
 Intestinal Forceps  
 Pinzas para coger tejidos e intestinos  
 Pinze per afferrare tessuti ed organi

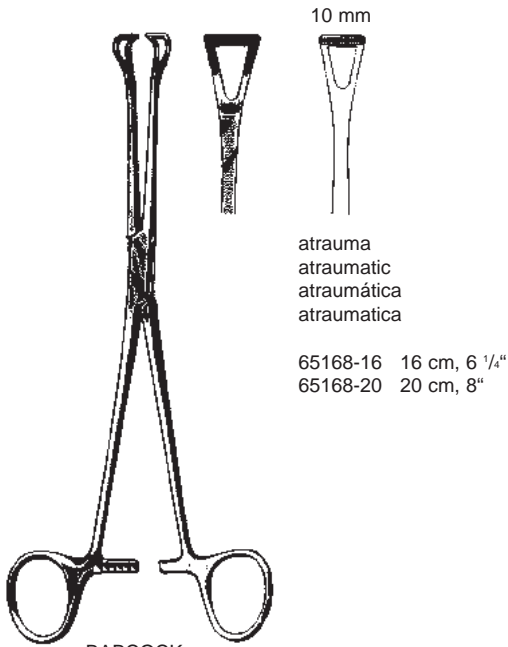

10 mm

atrauma  
 atraumatic  
 atraumática  
 atraumatica

65168-16 16 cm, 6 1/4"  
 65168-20 20 cm, 8"

**BABCOCK**  
 65160-14 14 cm, 5 1/2"  
 65160-16 16 cm, 6 1/4" **65164-16 TC 16 cm**  
 65160-18 18 cm, 7"  
 65160-20 20 cm, 8" **65164-20 TC 20 cm**  
 65160-24 24 cm, 9 1/2"

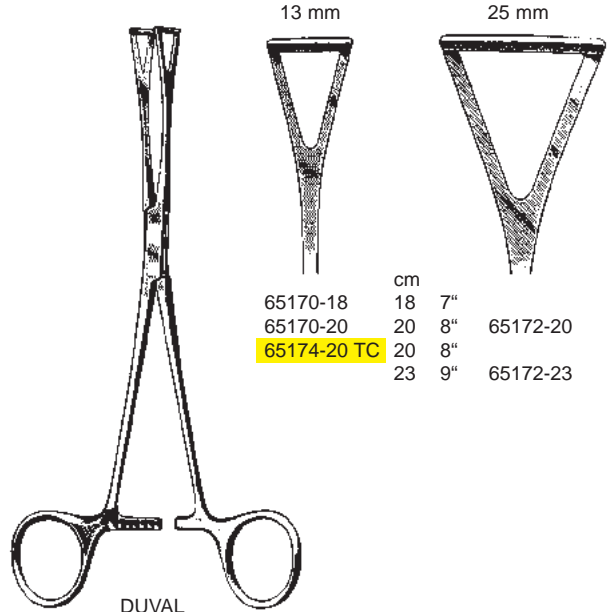

13 mm

25 mm

65170-18	18	7"	
65170-20	20	8"	65172-20
<b>65174-20 TC</b>	20	8"	
	23	9"	65172-23

**DUVAL**  
 65170-18 - 65172-23

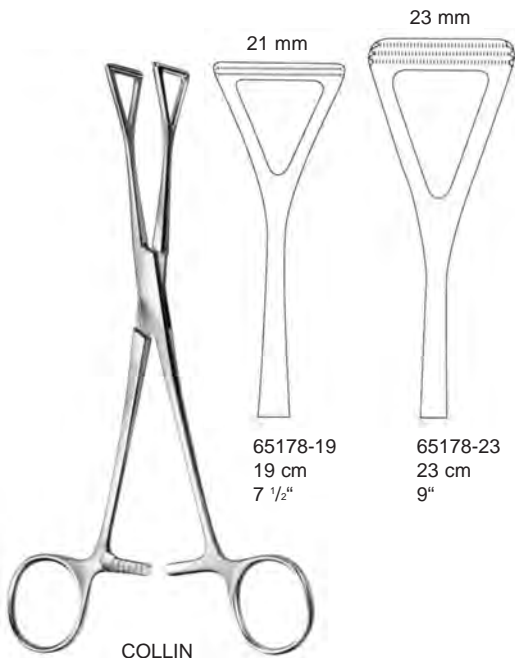

21 mm

23 mm

65178-19  
 19 cm  
 7 1/2"

65178-23  
 23 cm  
 9"

**COLLIN**



**WILLIAMS**  
 65180-16 16,5 cm, 6 1/2"



# MAST.SH-GERMANY

Darmklemmen  
 Intestinal Forceps  
 Pinzas intestinales  
 Pinze intestinali

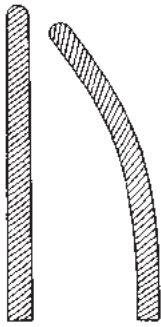
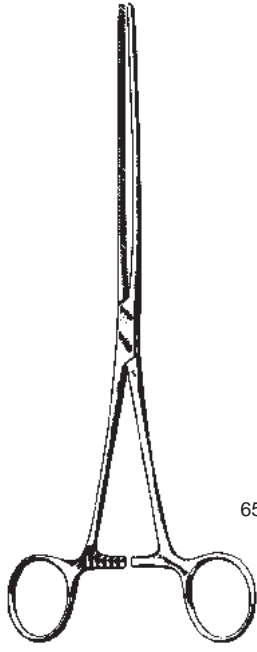

**DOYEN-BABY**  
 65210-18 65211-18  
 18 cm, 7"

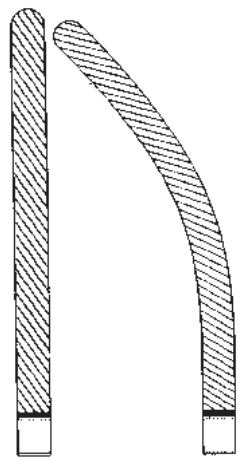

**DOYEN**  
 65210-21 21 cm, 8 1/4" 65211-21  
 65210-23 23 cm, 9" 65211-23

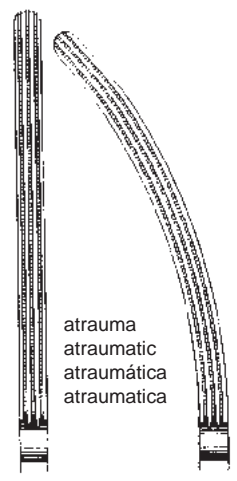

atrauma  
 atraumatic  
 atraumática  
 atraumatica

**DOYEN**  
 65216-13 13 cm, 5 1/8" 65217-13  
 65216-16 16 cm, 6 1/4" 65217-16  
 65216-18 18 cm, 7" 65217-18  
 65216-21 21 cm, 8 1/4" 65217-21  
 65216-23 23 cm, 9" 65217-23

**DOYEN**  
 65210-18 - 65217-23

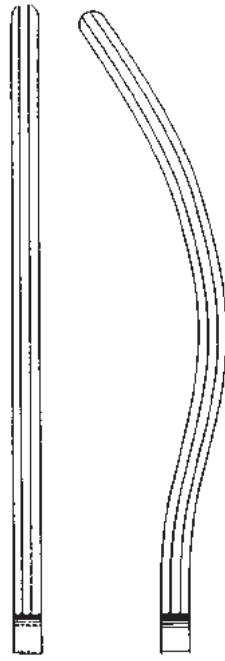
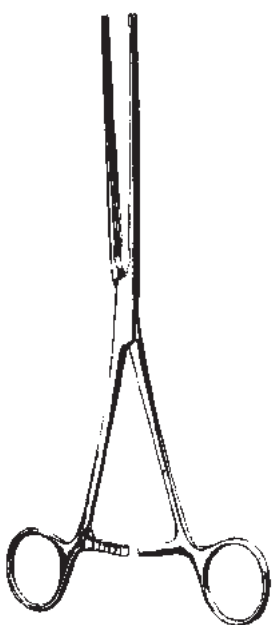

65220-13 13 cm, 5 1/8" 65221-13 **BABY-KOCHER**  
 65220-22 22 cm, 8 3/4" 65221-22  
 65220-25 25 cm, 10" 65221-25  
 65220-28 28 cm, 11" 65221-28

**KOCHER**  
 65220-22 - 65227-28

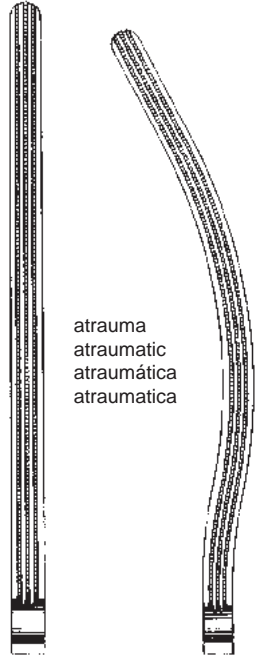

atrauma  
 atraumatic  
 atraumática  
 atraumatica

65226-22 22 cm, 8 3/4" 65227-22  
 65226-25 25 cm, 10" 65227-25  
 65226-28 28 cm, 11" 65227-28



Darmklemmen  
Intestinal Forceps  
Pinzas intestinales  
Pinze intestinali

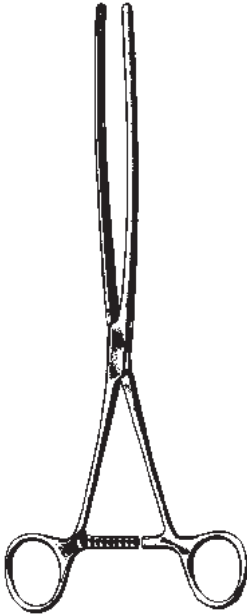

MAYO-ROBSON  
65230-21 - 65237-25  
21 - 25 cm  
8 1/4" - 10"

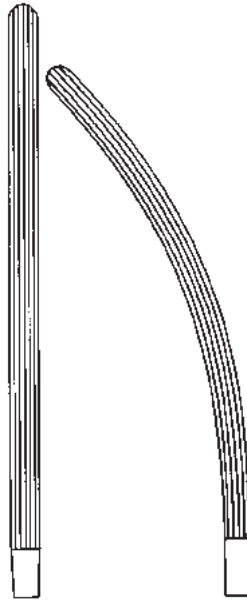

65230-21  
65230-23  
65230-25

65231-21  
65231-23  
65231-25

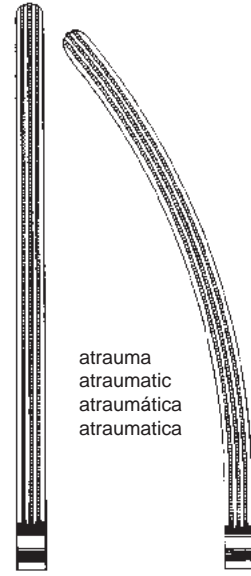

atrauma  
atraumatic  
atraumática  
atraumatica

65236-25

65237-25



SCUDDER  
65238-33  
33 cm  
13"

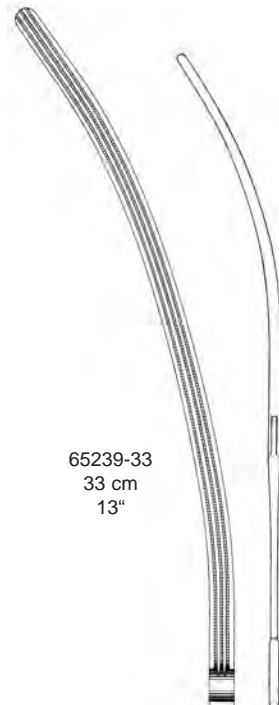

65239-33  
33 cm  
13"

Darmklemmen  
Intestinal Forceps  
Pinzas intestinales  
Pinze intestinali



FEHLAND  
65241-23  
23,5 cm 9 1/4"



RESANO  
65242-30  
30 cm, 11 3/4"



Magen-Darmklemmen  
 Intestinal and Stomach Clamps  
 Pinzas-clamps intestinales y estomacales  
 Pinze intestinali e stomacali

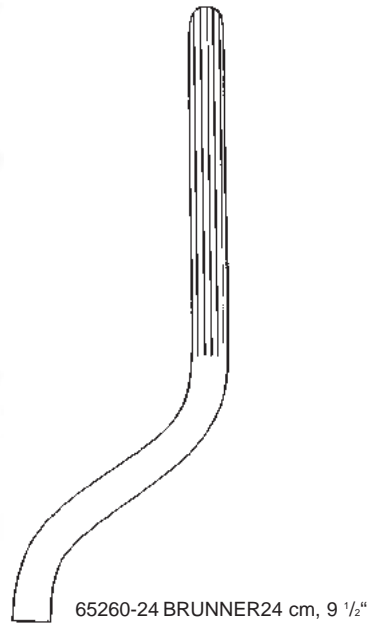
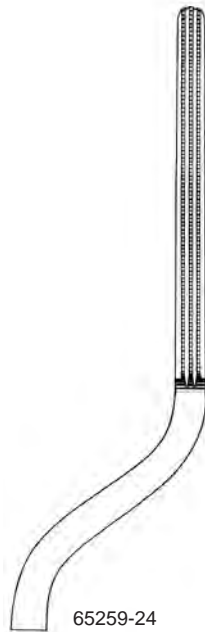
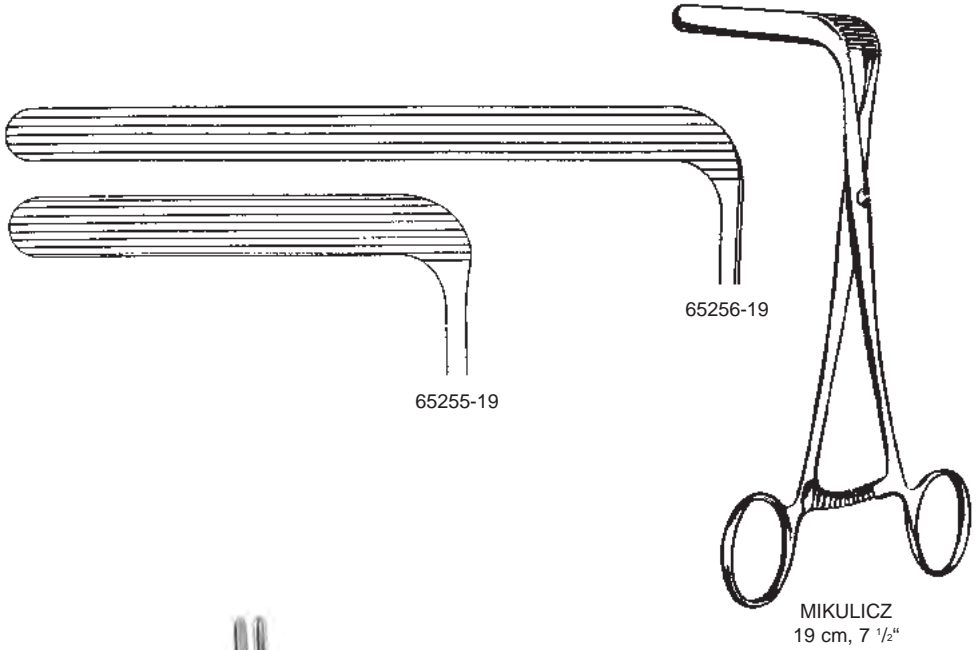



# MAST.SH-GERMANY

Pylorusspreizer, Blinddarmklemmen  
Pylorus spreader, Blindgut forceps  
Separador para píloro, Pinzas para apéndice  
Divaricatori per piloro, Pinza per appendice



BENSON  
65261-15  
15,5 cm, 6"

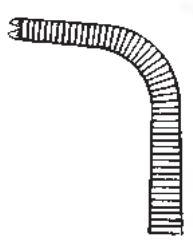

KLEINSCHMIDT  
65262-12  
12 cm, 4 3/4"

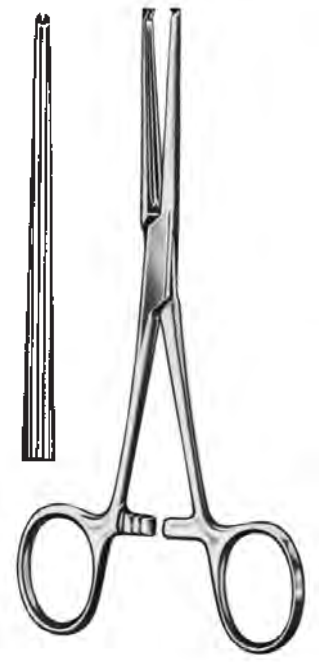

ALLEN  
65263-15 15 cm, 6"  
65263-20 20 cm, 8"



Atrauma Rektum-Anastomosenklemmen, Anastomosenklemmen  
Atrauma Sigmoid Anastomosis Forceps, Anastomosis Clamp Forceps  
Pinzas para anastomosis del recto atraumáticas, Pinzas clamps para anastomosis  
Pinze atrauma per anastomosi del retto, Pinze per anastomosi



**HAYES**  
65265-26 26 cm, 10 1/4"  
65265-28 28 cm, 11"

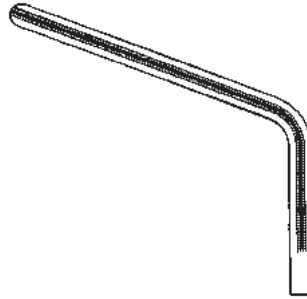

65265-26  
26 cm, 10 1/4"

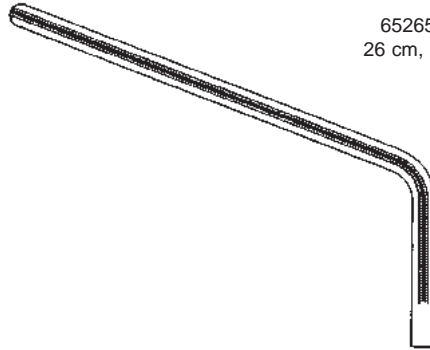

65265-28  
28 cm, 11"

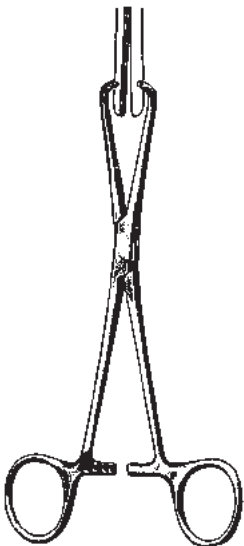

**STONE**  
65270-15  
15,5 cm, 6"



**STONE-WATT**  
65272-07 7,5 cm, 3"  
65272-10 10,0 cm, 4"



**STONE-WATT**  
65274-00

Magenquetschklemme  
Stomach Clamps  
Pinzas-clamps estomacales  
Pinze stomacali

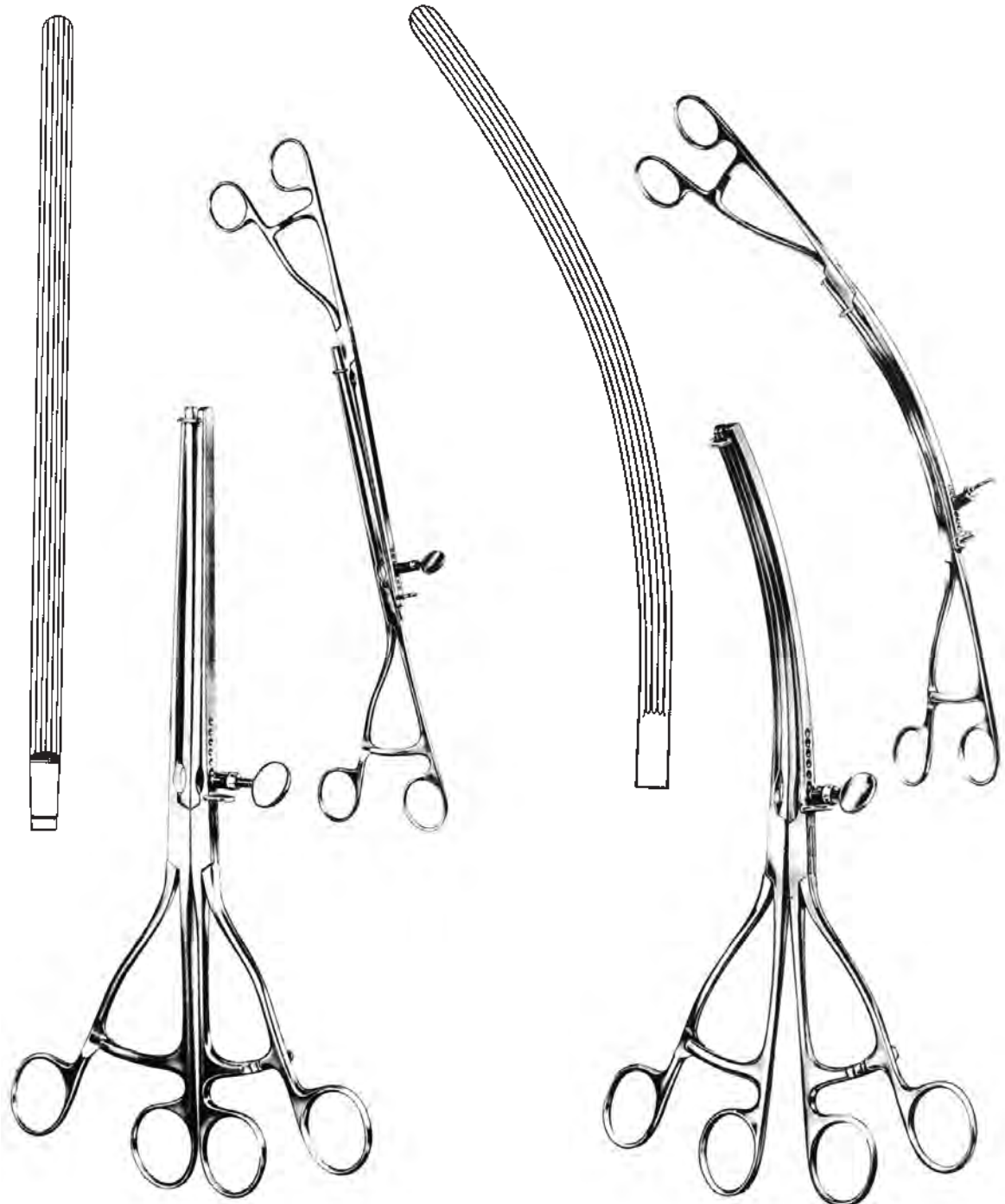

LANE  
65290-30 30 cm, 11 3/4"

LANE65291-30 30 cm, 11 3/4"

Darm- und Magenquetschklemmen  
 Intestinal and Stomach clamps  
 Pinzas-clamps intestinales y estomacales  
 Pinze e Schiacciatori per l'intestino e lo stomaco

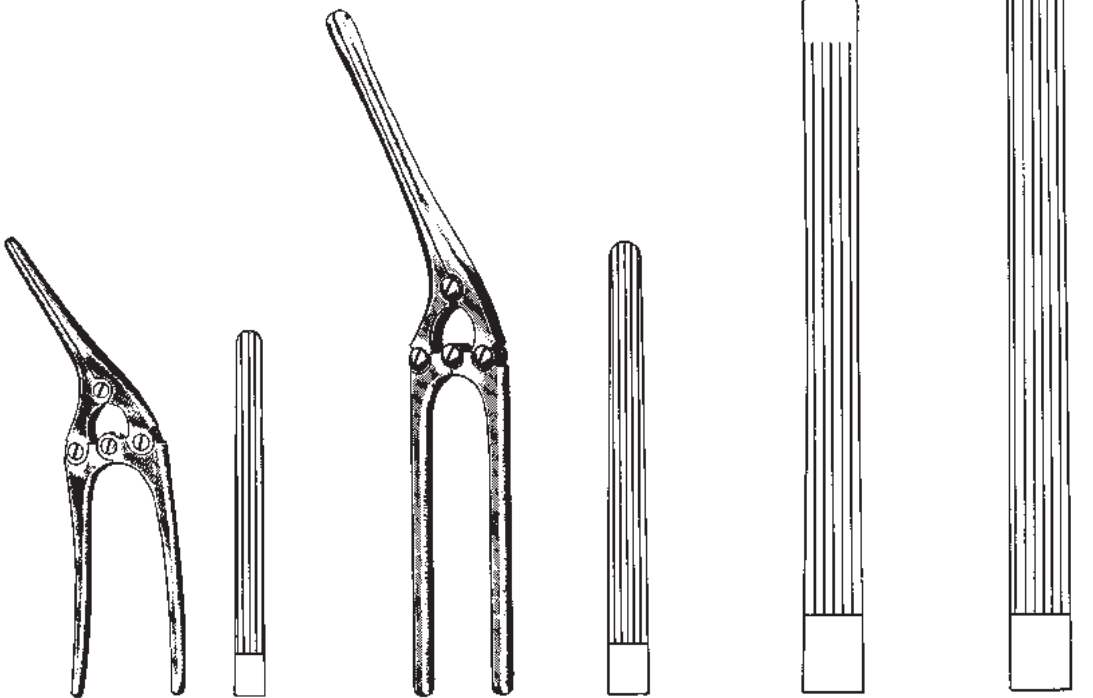

PAYR-BABY  
 65310-15  
 15 cm, 6"

PAYR

65310-21  
 21 cm, 8 1/4"

65310-29  
 29 cm, 11 1/2"

65310-35  
 35 cm, 14"

Prostatahaken, Kapselfaßzange, Prostatafaßzangen  
 Prostatic Retractors, Grasping Forceps for the capsule - Anterior Lobe - and Ligature Carrier  
 Separadores, Pinza para la próstata, para la cápsula, para lobo anterior, Porta-ligaduras  
 Divaricatori, Pinza per afferrare la prostata - per la capsula, per lobo anteriore

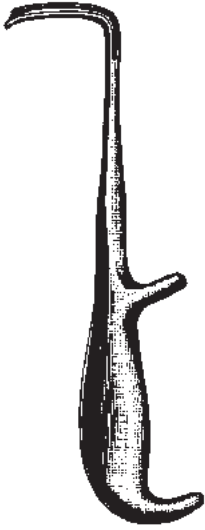

YOUNG  
67101-21  
21 cm, 8 1/4"



YOUNG  
67103-22  
22 cm, 8 3/4"



YOUNG  
67105-21  
21 cm, 8 1/4"



YOUNG  
67105-22  
22 cm, 8 3/4"

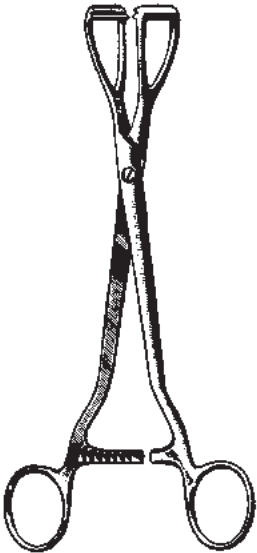

YOUNG  
67106-20  
20 cm, 8"



MILLIN  
67110-23  
23,5 cm, 9 1/4"

atrauma  
atraumatic  
atraumática  
atraumatica

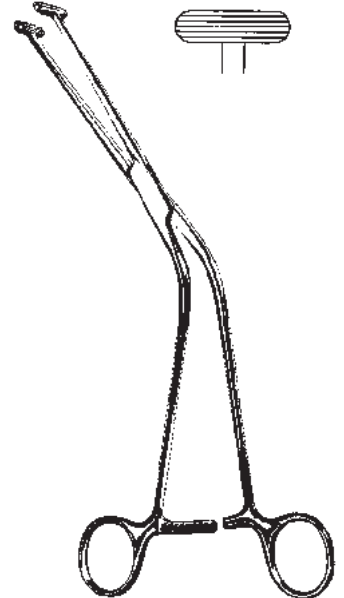

MILLIN  
67111-23  
23 cm, 9"

Kapselfaßzange, Prostatafaßzangen

Grasping Forceps for the capsule - Anterior Lobe - and Ligature Carrier

Pinza para la próstata, para la cápsula, para lobo anterior, Porta-ligaduras

Pinza per afferrare la prostata - per la capsula, per lobo anteriore, Portafilo

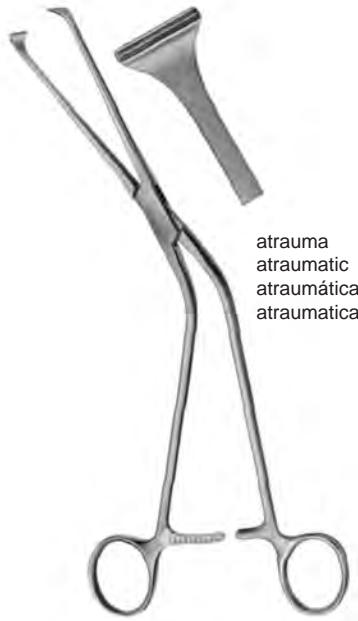

atrauma  
atraumatic  
atraumática  
atraumatica

MILLIN  
67122-23  
24,5 cm, 9 3/4"

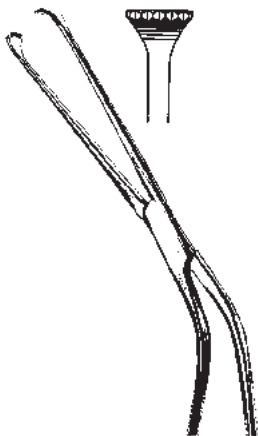

MILLIN  
67123-23  
23 cm, 9"

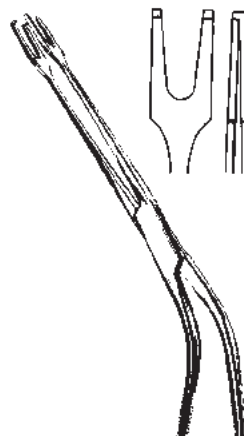

MILLIN  
67125-24  
24 cm, 9 1/2"



# MAST.SH-GERMANY

Prostatahaken, Blasenwundspreizer, Blasenspatel  
 Prostatic Retractors, Bladder Retractors  
 Separadores vesicales  
 Divaricatori vescicali, Spatoli vescicali

- 67130-01 2 Valven, 2 blades, 2 valvas, 2 valve 57 mm x 25 mm
- 67130-02 2 Valven, 2 blades, 2 valvas, 2 valve 80 mm x 25 mm
- 67130-03 1 Valven, 1 blade, 1 valva, 1 valve 120 mm x 45 mm



- 67130-00 ohne Kaltlicht
- 67132-00 Kaltlichtaufsatz für 67130-00
- 67130-00 without fiber optic
- 67132-00 fiber optic light carrier for 67130-00
- 67130-00 sin soporte de luz fría
- 67132-00 soporte de luz fría para 67130-00
- 67130-00 senza fibre ottiche
- 67132-00 supporto per luce fredda per 67130-00



LEGUEU 67147-27      KOCHER 67149-27



JUDD-MASSON

- 67150-00 mit Mittelvalve, with Central Blade  
con valva central, con valva centrale
- 67155-00 ohne Mittelvalve, without Central Blade  
sin valva central, senza valva centr.



THOMSON-WALKER 67160-00





**MAST.SH-GERMANY**

Blasenwundspreizer, Blasenhalssperrer, Urethrotome  
Bladder Retractors, Bladder Neck Spreader, Urethrotomes  
Separadores vesicales, Uretrótomos  
Divaricatori vescicali, Divaricatore del collo vescicale, Uretrotomi



LEGUEU  
67163-00



MILLIN  
67165-00

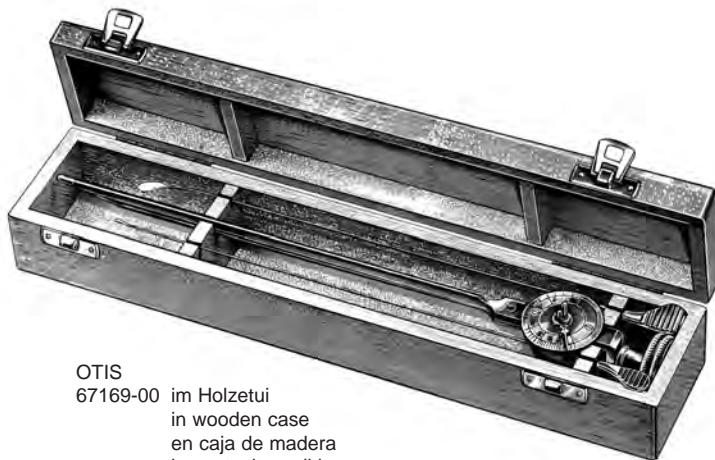

OTIS  
67169-00 im Holzetui  
in wooden case  
en caja de madera  
in contenitore di legno

67169-01 Ersatzblatt alleine  
Blade only  
Hoja de repuesto  
Lame di ricambio

Fremdkörperzange, Penisklemmen  
Foreign Body Forceps, Penis Seizing Forceps  
Pinzas para cuerpos extraños, Compresores uretrales  
Pinze per corpi estranei, Serrapene



MATHIEU  
67172-20 20 cm, 8"  
67172-28 28 cm, 11"



STOCKMANN  
67175-08  
8 cm, 3 1/8"



STRAUSS  
67177-11  
11 cm, 4 3/8"

Vasektomie-Klemme  
Vasectomy Forceps  
Pinza para vasectomia  
Pinza per vasectomia



67178-12  
12 cm, 4 <sup>3</sup>/<sub>4</sub>"

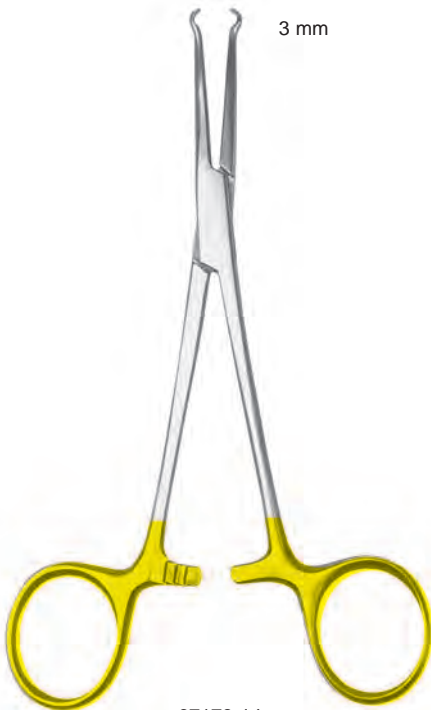

67178-14  
14 cm, 5 <sup>1</sup>/<sub>2</sub>"



67179-14 14,5 cm, 5 <sup>3</sup>/<sub>4</sub>"



# MAST.SH-GERMANY

Kathetereinführungsinstrumente, Dilatationsbougies  
 Catheter Introducer, Dilating Bougies  
 Introducator de catéteres, Bujías dilatadoras  
 Mandrini per sonda uretrali, Candelette dilatatrici



67185-35  
 35 cm, 13 3/4"

GUYON  
 67184-39  
 39 cm, 15 1/2"

Charr.	28 cm (11") VAN BUREN	25 cm (10") GUYON	28 cm (11") DITTEL	30 cm (11 3/4") DITTEL
8	67201-08	67205-08	67206-08	67207-08
9			67206-09	67207-09
10	67201-10	67205-10	67206-10	67207-10
11			67206-11	67207-11
12	67201-12	67205-12	67206-12	67207-12
13			67206-13	67207-13
14	67201-14	67205-14	67206-14	67207-14
15			67206-15	67207-15
16	67201-16	67205-16	67206-16	67207-16
17			67206-17	67207-17
18	67201-18	67205-18	67206-18	67207-18
19			67206-19	67207-19
20	67201-20	67205-20	67206-20	67207-20
21			67206-21	67207-21
22	67201-22	67205-22	67206-22	67207-22
23			67206-23	67207-23
24	67201-24	67205-24	67206-24	67207-24
25			67206-25	67207-25
26	67201-26	67205-26	67206-26	67207-26
27			67206-27	67207-27
28	67201-28	67205-28	67206-28	67207-28
29			67206-29	67207-29
30	67201-30	67205-30	67206-30	67207-30
32	67201-32	67205-32		
34	67201-34	67205-34		
36	67201-36	67205-36		
38		67205-38		
40		67205-40		



**MAST.SH-GERMANY**

Metallkatheter  
Metal Catheters  
Sondas metálicas  
Sonde metalliche

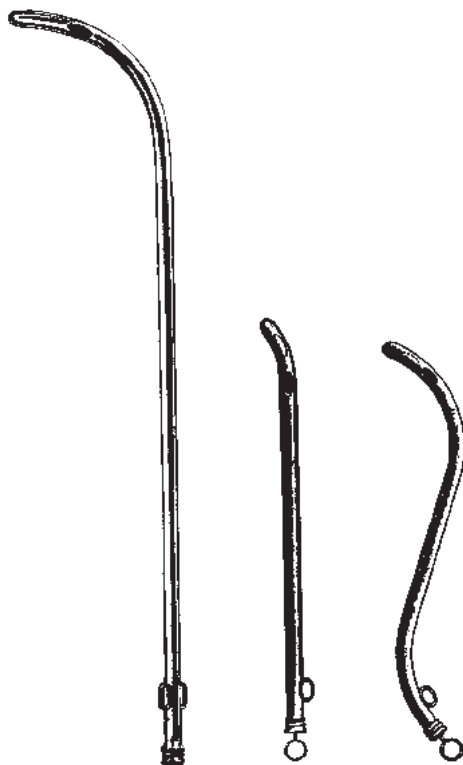

29 cm  
11 1/2"

15 cm  
6"

COXETER

Charr.  
FG

6	67211-06	67213-06	
8	67211-08	67213-08	67219-08
10	67211-10	67213-10	67219-10
12	67211-12	67213-12	67219-12
14	67211-14	67213-14	67219-14
16	67211-16	67213-16	67219-16
18	67211-18	67213-18	67219-18
20	67211-20	67213-20	67219-20
22	67211-22	67213-22	67219-22
24	67211-24	67213-24	67219-24



# MAST.SH-GERMANY

Beschneidungsinstrument  
Circumcision Instrument  
Instrumentos para circuncisión  
Strumenti per circoncisione

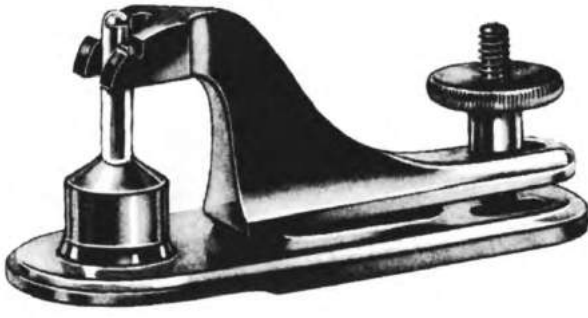

- 67240-08 8 mm Ø
- 67240-11 11 mm Ø
- 67240-13 13 mm Ø
- 67240-16 16 mm Ø
- 67240-21 21 mm Ø
- 67240-26 26 mm Ø
- 67240-32 32 mm Ø

67240-08 - 67240-32



### MOGEN

- 67250-07 7,5 cm (3") 2,5 mm
  - 67251-07 7,5 cm (3") 1,5 mm
- für Kinder  
for children  
para niños  
per bambini



**MAST.SH-GERMANY**

Mastdarm-Spekula  
Rectal Specula  
Espéculos rectales  
Specoli rettali



CZERNY  
69105-22  
22 cm, 8 3/4"



SIMS  
69110-15  
15 cm, 6"



BODENHAMMER  
69115-15  
15 cm, 6"

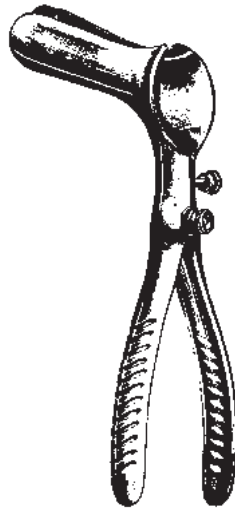

PRATT  
69121-00  
19 cm, 7 1/2"

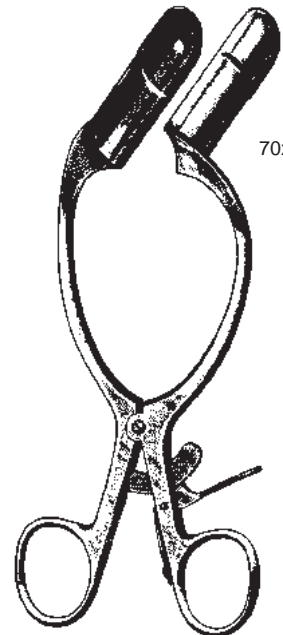

BARR  
69125-17  
17 cm, 6 3/4"

70x22 mm



# MAST.SH-GERMANY

Mastdarm-Spekula  
Rectal Specula  
Espécúlos rectales  
Specoli rettali



HILL-FERGUSON, 20 cm, 8"  
69126-01 6,4x2,2 cm 2 1/2" x 7/8"  
69126-02 7,6x3,0 cm 3" x 1 3/16"  
69126-03 7,6x3,6 cm 3" x 1 7/16"



SAWYER, 25 cm, 9 3/4"  
69127-01 6,4x2,2 cm 2 1/2" x 7/8"  
69127-02 7,6x2,9 cm 3" x 1 1/8"  
69127-03 8,9x3,8 cm 3 1/2" x 1 1/2"



MATHIEU  
69130-19  
19,5 cm, 7 3/4"



SCHULZE-BERGMANN

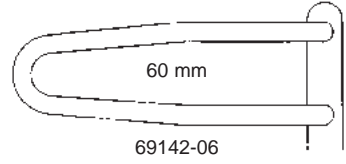

69142-06

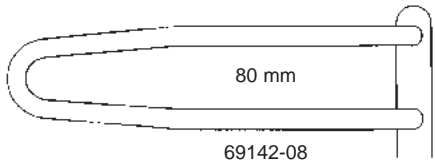

69142-08

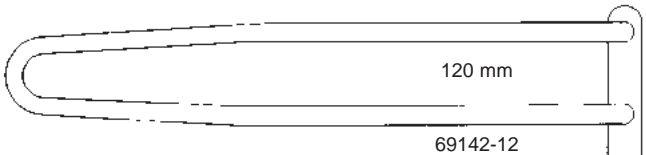

69142-12





**MAST.SH-GERMANY**

Analpreizer  
Anal Retractors  
Separadores rectales  
Dilatatori per l'ano e il retto

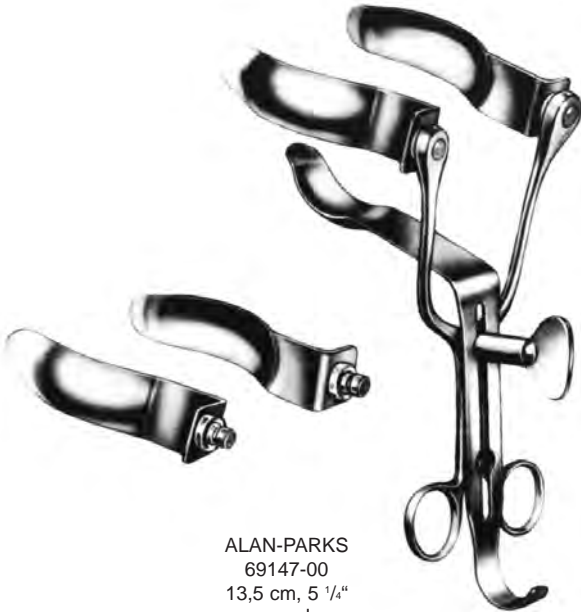

ALAN-PARKS  
69147-00  
13,5 cm, 5 1/4"  
compl.

69148-00  
Kaltlicht Zubehör für 69147-00  
Cold Light Attachment for 69147-00  
Adaptador para luz fría 69147-00  
Adattatore luce fredda per 69147-00

69147-02 Mittelblatt allein  
Center blade, only  
Valva central, solo  
Valva centrale, sola

69147-03 Blatt allein 75 mm, 3"  
Blade only 75 mm, 3"  
Valva sola 75 mm, 3"  
Valva sola 75 mm, 3"

69147-04 Blatt allein 95 mm, 3 3/4"  
Blade only 95 mm, 3 3/4"  
Valva sola 95 mm, 3 3/4"  
Valva sola 95 mm, 3 3/4"

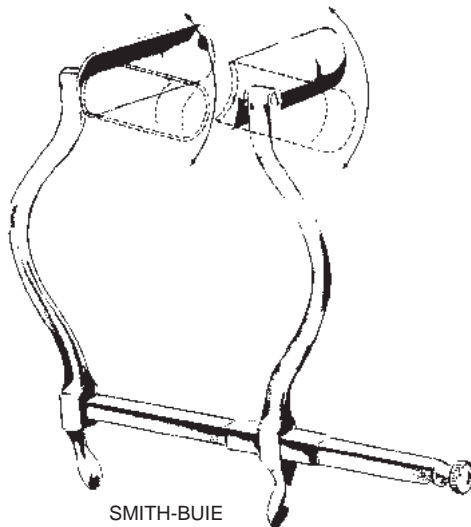

SMITH-BUIE  
69150-15  
15 cm, 6"  
75x23 mm



# MAST.SH-GERMANY

Anuskope, Proktoskope  
Anoscopes, Proctoscopes  
Anoscopios, Proctoscopios  
Anoscopi, Protoscopi

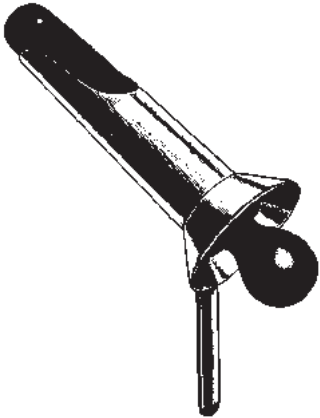

IVES-FANSLER  
69210-22 22 mm Ø  
L = 80 mm



Ø mm    HIRSCHMANN  
16        69212-16  
19        69212-19  
22        69212-22  
L = 65 mm



mm  
ØxL        KELLY  
22x 50     69220-05  
22x100    69220-10  
22x140    69220-14  
22x200    69220-20



Anuskope, Proktoskope, Fistelsonde  
Anoscopes, Proctoscopes, Fistula Probe  
Anoscopios, Proctoscopios, Sondas para fistulas  
Anoscopi, Protoscopi, Sonde per fistole



Ø mm KELLY  
21 69224-21  
27 69224-27  
L = 50 mm, 2"

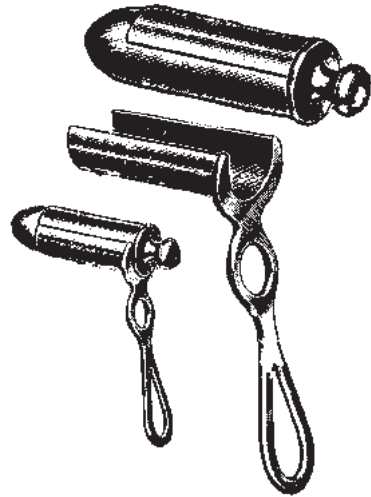

Ø mm CHELSEA-EATON  
22 x 65 69225-22  
30 x 65 69225-30



Fig. 1  
69251-01

Fig. 2  
69251-02

Fig. 3  
69251-03

PRATT  
21 cm, 8 1/4"  
69251-01 - 69251-03



# MAST.SH-GERMANY

Proktoskope  
Proctoscopes  
Proctoscopios  
Protoscopi

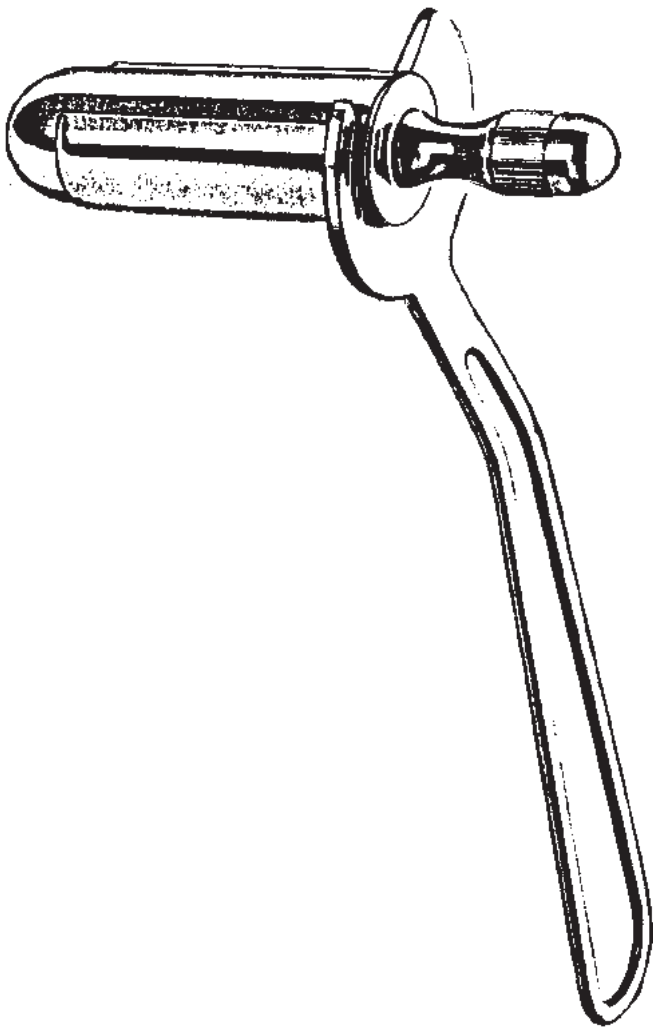

Ø	FANSLER, 24 cm, 9 1/2"
65 x 25 mm	69226-25
65 x 29 mm	69226-29
70 x 38 mm	69226-38



**MAST.SH-GERMANY**

Proktoskope  
Proctoscopes  
Proctoscopios  
Protoscopi



**MORGAN**

69227-01	17 mm Ø	L=65 mm
69227-02	17 mm Ø	L=80 mm
69227-03	20 mm Ø	L=65 mm
69227-04	20 mm Ø	L=80 mm
69227-05	24 mm Ø	L=65 mm
69227-06	24 mm Ø	L=80 mm

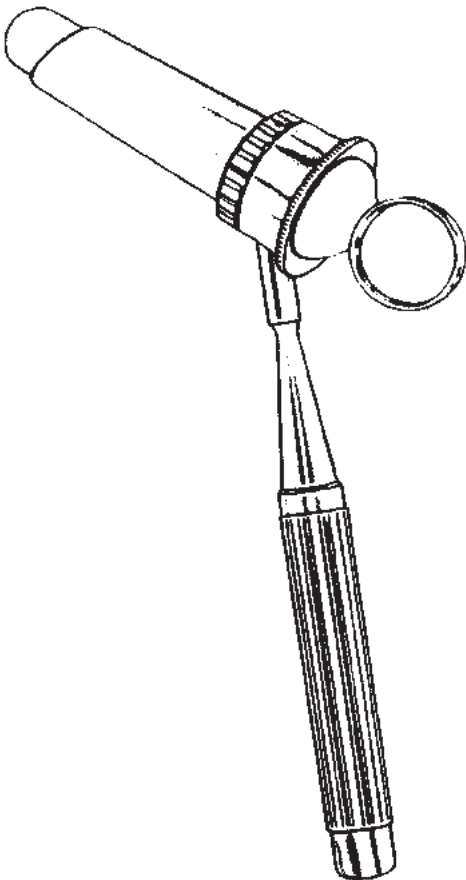

69228-01

Beleuchtungsstab für Morgan  
Illumination attachment for Morgan  
Mango con iluminación para Morgan  
Dispositivo Illuminativo per Morgan

**BENSAUDE**

69229-01	19 mm Ø	L=70 mm
69229-02	22 mm Ø	L=70 mm



# MAST.SH-GERMANY

Rektal Absaugrohr, Rektalschnürer, Mastdarmbiopsiezangen  
 Rectal aspiration cannula, Rectal snare, Rectal Biopsy Specimen Forceps  
 Cánula de aspiración rectal, Cierra-nudo rectal, Pinzas para biopsia rectal  
 Cannula d'aspirazione rettale, Serranodi, Pinze taglianti per biopsia rettale



BUIE  
 69261-41  
 41 cm, 16"

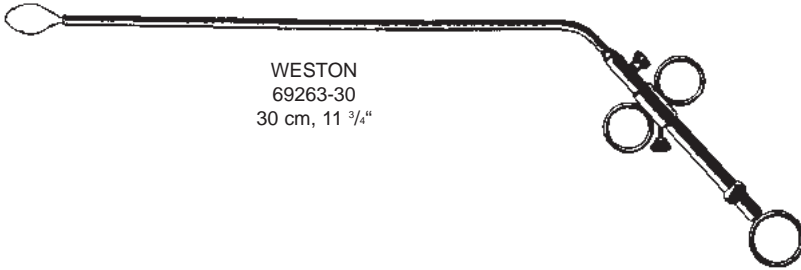

WESTON  
 69263-30  
 30 cm, 11 3/4"

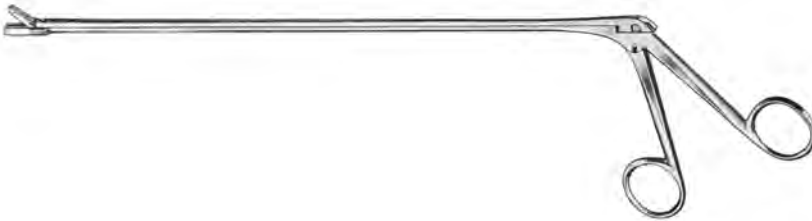

YEOMAN  
 69301-28 - 69304-42

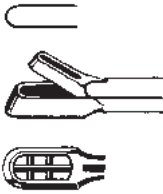

Fig. 1  
 69301-28 28 cm, 11"  
 69301-35 35 cm, 13 3/4"  
 69301-42 42 cm, 16 1/2"

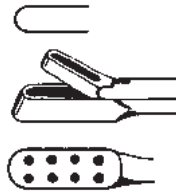

Fig. 2  
 69302-28 28 cm, 11"  
 69302-35 35 cm, 13 3/4"  
 69302-42 42 cm, 16 1/2"

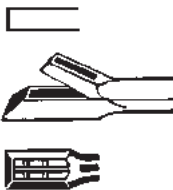

Fig. 3  
 69303-28 28 cm, 11"  
 69303-35 35 cm, 13 3/4"  
 69303-42 42 cm, 16 1/2"

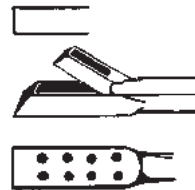
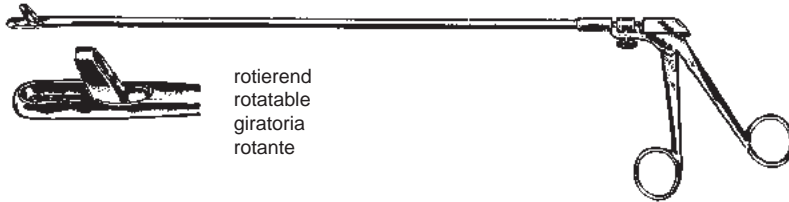

Fig. 4  
 69304-28 28 cm, 11"  
 69304-35 35 cm, 13 3/4"  
 69304-42 42 cm, 16 1/2"

Mastdarm-Biopsiezangen rotierend, Hämorrhoidalzange  
 Rectal Biopsy Specimen Forceps rotatable, Haemorrhoidal Forceps  
 Pinzas para biopsia rectal, giratoria, Pinzas-clamps hemorroidales  
 Pinze taglianti per biopsia rettale, rotante, Pinze per emorroidi



rotierend  
 rotatable  
 giratoria  
 rotante

YEOMANN

69311-23 23 cm, 9"  
 69311-33 33 cm, 13"  
 69311-40 40 cm, 15 3/4"

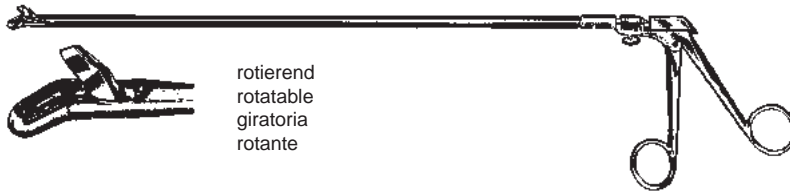

rotierend  
 rotatable  
 giratoria  
 rotante

TURREL

69321-23 23 cm, 9"  
 69321-33 33 cm, 13"  
 69321-40 40 cm, 15 3/4"

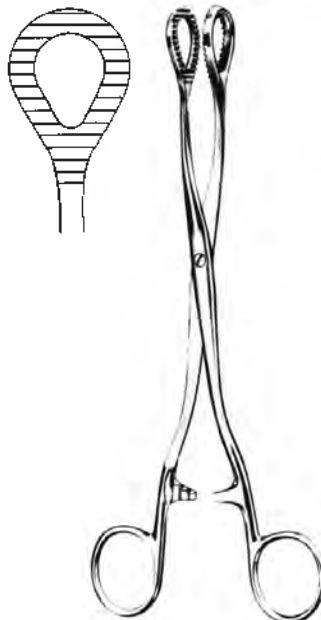

HEYWOOD-SMITH

69402-21 21 cm, 8 1/4"  
 69402-25 25 cm, 10"



# MAST.SH-GERMANY

Hämorrhoidal-Ligatoren, Hämorrhoidalzangen  
 Haemorrhoidal Ligators, Haemorrhoidal Forceps  
 Ligadores para hemorroides, Pinzas-clamps para hemorroides  
 Legatori emorroidali, Pinze per emorroidi

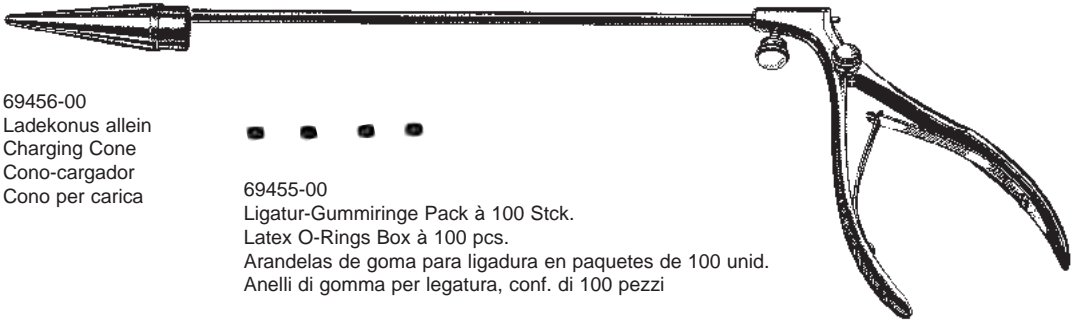

69456-00  
 Ladekonus allein  
 Charging Cone  
 Cono-cargador  
 Cono per carica



69455-00  
 Ligatur-Gummiringe Pack à 100 Stck.  
 Latex O-Rings Box à 100 pcs.  
 Arandelas de goma para ligadura en paquetes de 100 unid.  
 Anelli di gomma per legatura, conf. di 100 pezzi

MC GIVNEY  
 LI GATOR  
 69450-18  
 18 cm, 7"

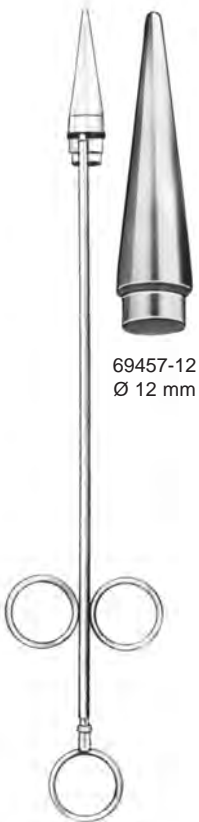

69457-12  
 Ø 12 mm

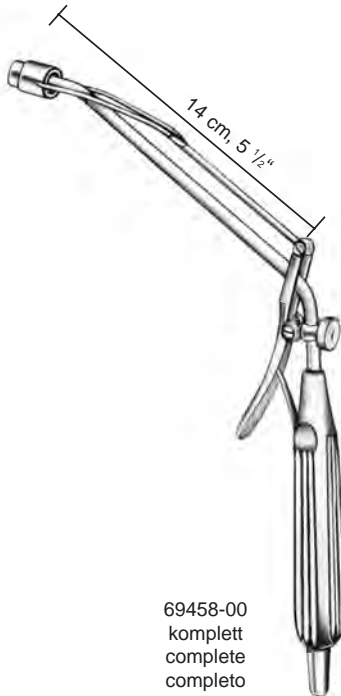

69458-00  
 komplett  
 complete  
 completo



Ø 10 mm  
 69458-10  
 Ladekonus  
 Charging cone  
 Cono-cargador  
 Cono per carica



Ø 10 mm  
 69458-11 11 mm  
 69458-16 16 mm  
 Saugkopf  
 Aspiration tip  
 Cabeza de aspiración  
 Testa d'aspirazione

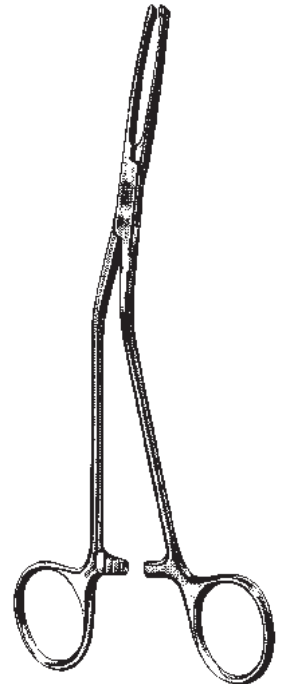

MC GIVNEY  
 69460-00  
 19 cm, 7 1/2"

RUDD  
 69457-31  
 31,5 cm, 12 1/2"  
 kplt./cplt.





**MAST.SH-GERMANY**

Lateral-Scheidenspekula  
Lateral Vaginal Retractor  
Espéculos vaginales  
Specoli vaginali



71100-00

Lateralspreizer allein  
Vaginal retractor lateral only  
Espéculo vaginal solo  
Specolo vaginale laterale, solo

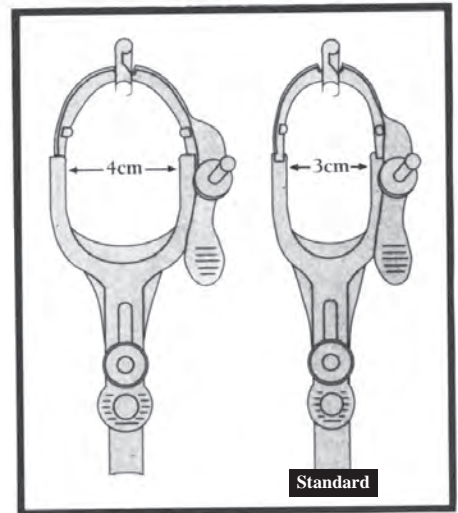

**VU-MORE**

Fig.	mm	
2	95x35	71115-02
3	115x35	71115-03



# MAST.SH-GERMANY

Scheidenspekula  
Vaginal Specula  
Espéculos vaginales  
Specoli vaginali

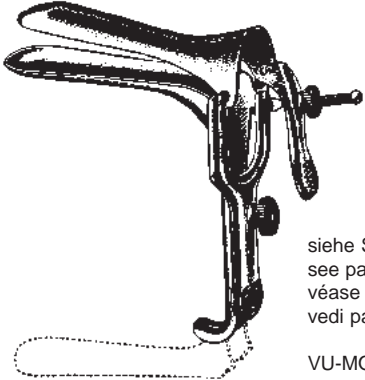

siehe Seite 569  
see page no. 569  
véase pagina no. 569  
vedi pagina nr. 569

VU-MORE

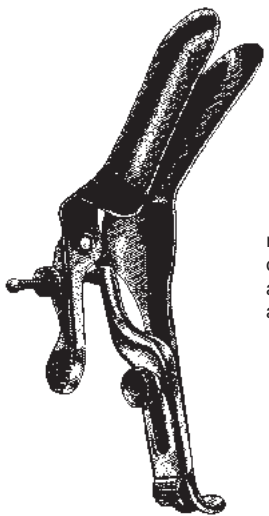

rechts offen  
open right-side  
abierto a la derecha  
aperta a destra

GRAVE  
71116-02

mittel, medium, mediano, medio  
101x35 mm

GRAVE

Fig.	mm	Standard
1	75x20	71110-01
2	95x35	71110-02
3	115x35	71110-03

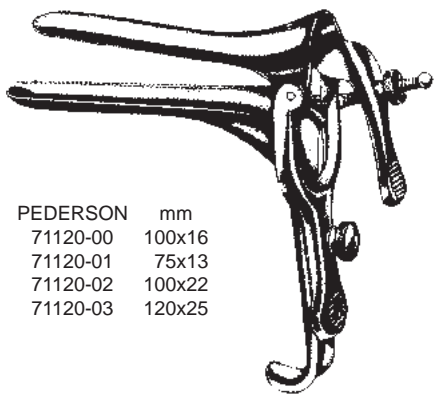

Fig.	PEDERSON	mm
	71120-00	100x16
1	71120-01	75x13
2	71120-02	100x22
3	71120-03	120x25

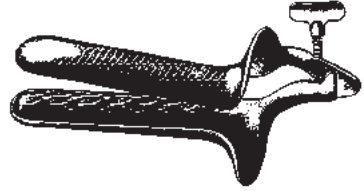
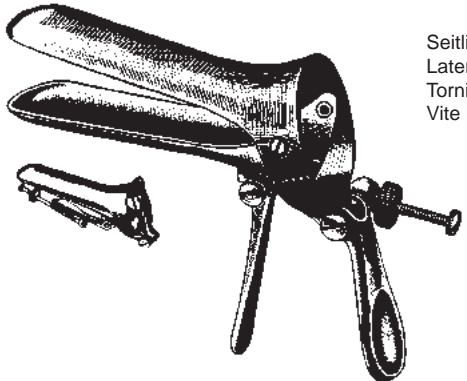
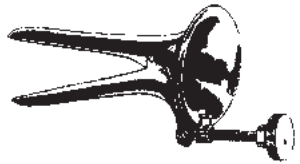

Fig.	COLLIN	mm
1	71130-01	85x30
2	71130-02	100x35
3	71130-03	110x40



Seitliche Schraube  
Lateral Screw  
Tornillo lateral  
Vite laterale

Fig.	mm	Standard
1	75x32	71140-01
2	85x35	71140-02
3	100x35	71140-03
4	75x17	71142-04



COLLIN  
71132-00  
65x10 mm

für Jungfrauen  
for virgins  
para vírgenes  
per vergini



**MAST.SH-GERMANY**

Scheidenspekula  
Vaginal Specula  
Espécules vaginales  
Specoli vaginali

Mittelschraube  
Central Screw  
Tornillo central  
Vite centrale

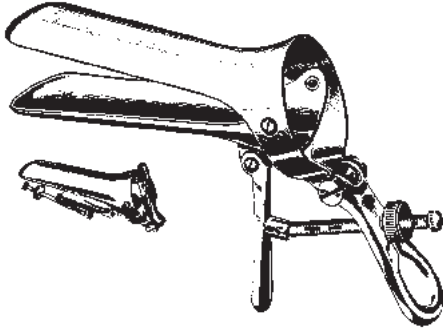

Fig.	CUSCO	mm
1	71150-01	75x32
2	71150-02	85x35
3	71150-03	100x37

Schweizer Modell  
Swiss Pattern  
Modelo suizo  
Modello svizzero

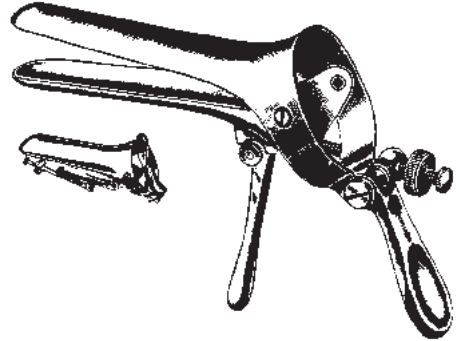

Fig.	CUSCO	mm
1	71160-01	90x23-25
2	71160-02	100x25-27
3	71160-03	110x27-30



	SEMM	mm
71161-17	100 x 17 - 20 mm	
71161-25	100 x 25 - 30 mm	

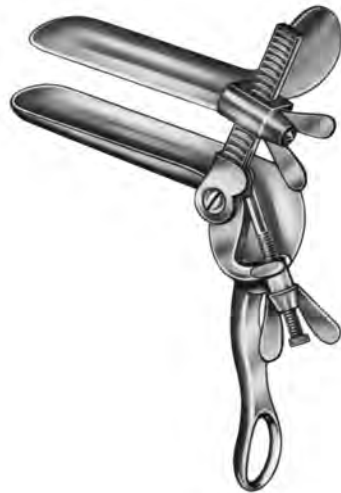

Fig.	TRÉLAT	mm
1	71170-01	85x33
2	71170-02	95x35
3	71170-03	115x43



Scheidenspekula  
 Vaginal Specula  
 Espéculos vaginales  
 Specoli vaginali

Satz bestehend aus je 1 Spekula und 1 Halter  
 Set consisting of 1 specula and 1 retractor  
 Juego de 1 espéculo y 1 valva  
 Serie da 1 specolo e 1 valva

Spekula  
 Speculum  
 Espéculo  
 Specolo

Halter  
 Retractor  
 Valva  
 Valve



Fig. KRISTELLER  
 1 71210-01  
 2 71210-02  
 3 71210-03



Fig. KRISTELLER mm  
 1 71211-01 70x27  
 2 71211-02 80x30  
 3 71211-03 90x36



Fig. KRISTELLER mm  
 1 71212-01 75x23  
 2 71212-02 85x26  
 3 71212-03 100x32

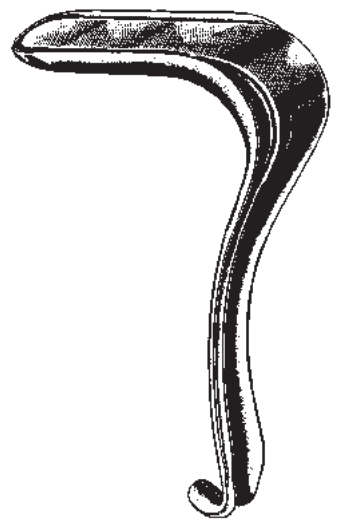

Fig. KRISTELLER  
 00 71240-00  
 0 71240-10  
 1 71240-01  
 2 71240-02  
 3 71240-03

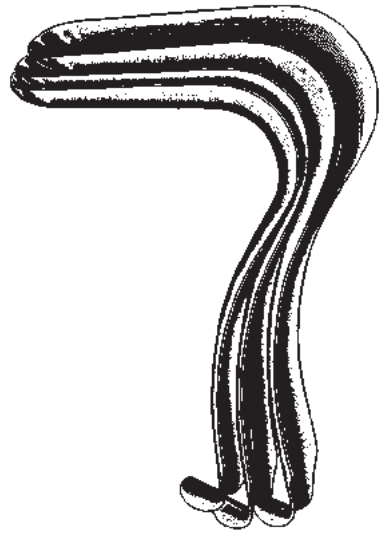

Fig. KRISTELLER mm  
 00 71241-00 110x18  
 0 71241-10 110x21  
 1 71241-01 110x27  
 2 71241-02 110x30  
 3 71241-03 110x36

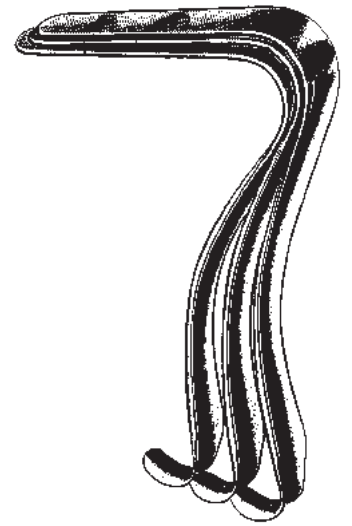
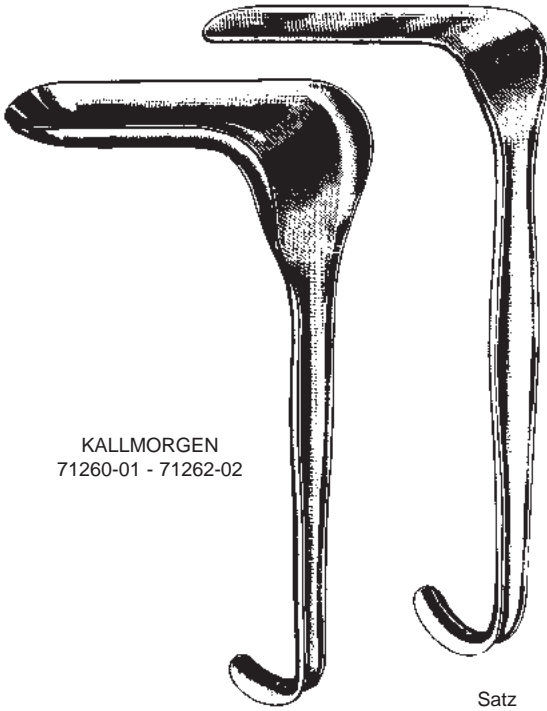

Fig. KRISTELLER mm  
 00 71242-00 115x14  
 0 71242-10 115x17  
 1 71242-01 115x23  
 2 71242-02 115x26  
 3 71242-03 115x32



**MAST.SH-GERMANY**

Scheidenspekula  
Vaginal Specula  
Espéculos vaginales  
Specoli vaginali



KALLMORGEN  
71260-01 - 71262-02

Fig.	Serie	Spekula Speculum Espéculo Specolo	Halter Retractor Valva	mm	Valve	mm
1	71260-01	71261-01	70x40	71262-01	70x33	
2	71260-02	71261-02	90x40	71262-02	90x33	



Fig.	JACKSON	mm
1	71271-01	75x38
2	71271-02	90x38
3	71271-03	100x38



Fig.	SIMS	mm
1	71281-01	63x32
2	71281-02	76x32
3	71281-03	89x38

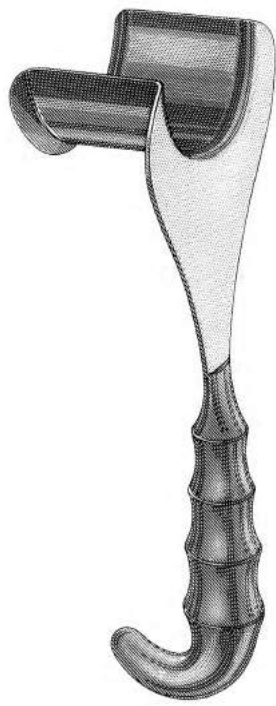

Fig.	SIMS	mm
1	71291-01	60x25+30
2	71291-02	70x30+35
3	71291-03	80x35+40
Set	71291-00	(Fig. 1,2,3)



# MAST.SH-GERMANY

Scheidenspekula  
 Vaginal Specula  
 Espécúlos vaginales  
 Specoli vaginali



DELEE  
 71300-01  
 23,5 cm, 9 1/4"

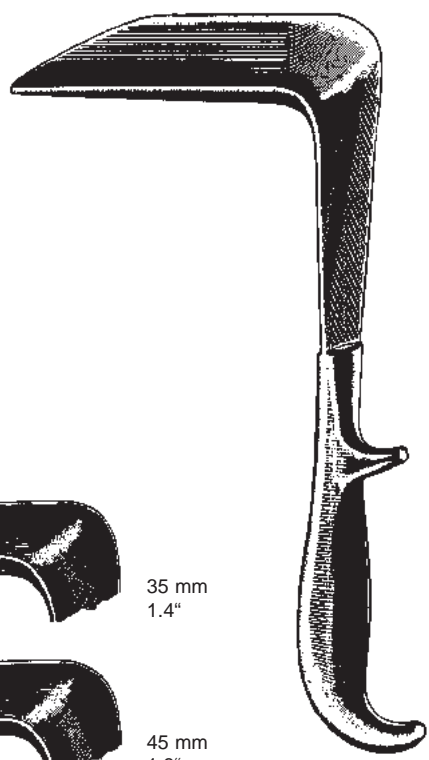

DOYEN  
 24 cm, 9 1/2"

leicht hohl  
 slightly concave  
 ligeramente concavos  
 leggermente concavi

Fig.		mm
1	71301-01	55x35
2	71301-02	85x35
3	71301-03	115x35



35 mm  
 1.4"

Fig.		mm
1	71303-01	55x45
2	71303-02	85x45
3	71303-03	115x45
4	71303-04	160x45
5	71303-05	180x45



45 mm  
 1.8"

Fig.		mm
1	71305-01	55x60
2	71305-02	85x60
3	71305-03	115x60
4	71305-04	160x60
5	71305-05	180x60



60 mm  
 2.4"

Scheidenspekula  
 Vaginal Specula  
 Espécúlos vaginales  
 Specoli vaginali

71306-01  
 80 x 30 mm

71306-02  
 85 x 35 mm

71306-03  
 90 x 40 mm



71306-01 - 71306-03

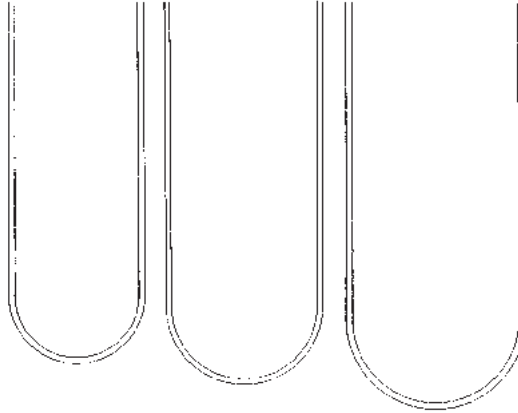

71306-04  
 Gewicht 400 gr  
 weight 400 grs  
 peso 400 grs  
 peso 400 grs

71306-05  
 Gewicht 800 gr  
 weight 800 grs  
 peso 800 grs  
 peso 800 grs

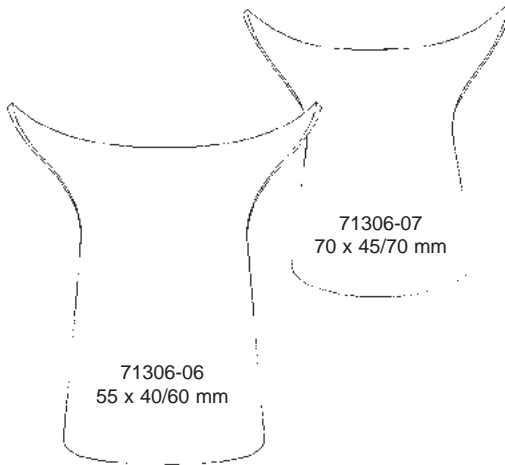

71306-07  
 70 x 45/70 mm

71306-06  
 55 x 40/60 mm

SCHERBAK  
 71306-00  
 Set komplett  
 complete set  
 juego completo  
 set completo



71306-08  
 Griff, handle,  
 mango, manico



# MAST.SH-GERMANY

Scheidenspekula  
 Vaginal Specula  
 Espéculos vaginales  
 Specoli vaginali



O'SULLIVAN-O'CONNOR  
 71308-00



Fig. 1 = 45 x 17 mm 71308-01  
 Fig. 2 = 90 x 37 mm 71308-02  
 Fig. 3 = 90 x 45 mm 71308-03

71308-00

komplett bestehend aus:

1 Rahmen mit 2 beweglichen Seitenvälven  
 3 austauschbare Mittelvälven Fig. 1-3

1 frame with 2 mobile lateral blades  
 3 interchangeable blades Fig. 1-3

1 Marco con 2 separadores móviles laterales  
 3 separadores centrales intercambiables fig. 1-3

1 telaio regolabile con 2 valve laterali mobili  
 3 valve intercambiabili fig. 1-3

71308-04  
 Rahmen allein  
 Frame only  
 Marco solo  
 Telaio solo

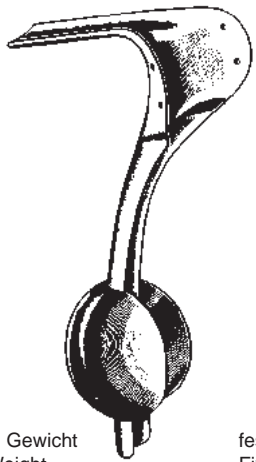

abnehmbares Gewicht  
 Detachable Weight  
 Peso desmontable  
 Peso smontabile

71307-00  
 1,4 kg  
 75 x 38 mm

AUVARD  
 24 cm, 9 1/2"

festes Gewicht  
 Fixed Weight  
 Peso fijo  
 Peso fisso

71309-00  
 1,4 kg  
 105 x 38 mm





Scheidenspekula, Endospekula  
 Vaginal Specula, Endospecula  
 Espéculos vaginales, Endo-espéculos  
 Specoli vaginali, Endospecoli



mm	BREISKY	
100x20	71310-20	28 cm, 11"
100x25	71310-25	28 cm, 11"
100x30	71310-30	28 cm, 11"
100x35	71310-35	28 cm, 11"
100x40	71310-40	28 cm, 11"
130x20	71313-20	33 cm, 13"
130x25	71313-25	33 cm, 13"
130x30	71313-30	33 cm, 13"
130x35	71313-35	33 cm, 13"
130x40	71313-40	33 cm, 13"
155x40	71315-40	35 cm, 13 3/4"



mm	LANDAU	
100x28	71319-28	29 cm, 11 1/2"
100x38	71319-38	29 cm, 11 1/2"

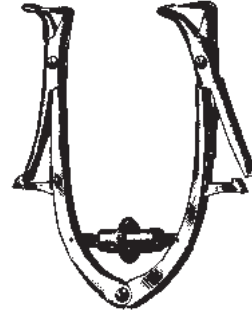

FRIEDMANN	
71351-15	15 cm, 6"



KOGAN		
71360-24	3 mm	24 cm, 9 1/2"
71361-24	4 mm	24 cm, 9 1/2"
71362-24	5 mm	24 cm, 9 1/2"



KOGAN		
71363-24	3 mm	24 cm, 9 1/2"
71364-24	4 mm	24 cm, 9 1/2"
71365-24	5 mm	24 cm, 9 1/2"



# MAST.SH-GERMANY

Uterus Dilatoren  
 Uterine Dilators  
 Dilatadores uterinos  
 Dilatatori uterini

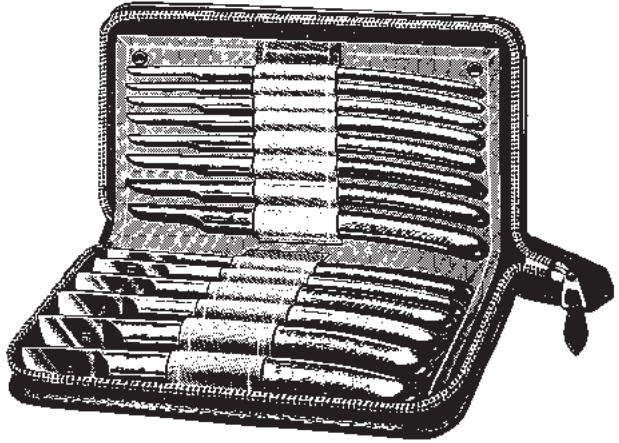

mm Ø	HEGAR		mm Ø
1	71410-01	71415-01	1,5
2	71410-02	71415-02	2,5
3	71410-03	71415-03	3,5
4	71410-04	71415-04	4,5
5	71410-05	71415-05	5,5
6	71410-06	71415-06	6,5
7	71410-07	71415-07	7,5
8	71410-08	71415-08	8,5
9	71410-09	71415-09	9,5
10	71410-10	71415-10	10,5
11	71410-11	71415-11	11,5
12	71410-12	71415-12	12,5
13	71410-13	71415-13	13,5
14	71410-14	71415-14	14,5
15	71410-15	71415-15	15,5
16	71410-16	71415-16	16,5
17	71410-17	71415-17	17,5
18	71410-18	71415-18	18,5
19	71410-19	71415-19	19,5
20	71410-20		
21	71410-21		
22	71410-22		
23	71410-23		
24	71410-24		
25	71410-25		
26	71410-26		
27	71410-27		
28	71410-28		
29	71410-29		
30	71410-30		

HEGAR  
 71405-14 4-17 mm  
 14 St./pces./pzas./pezzi

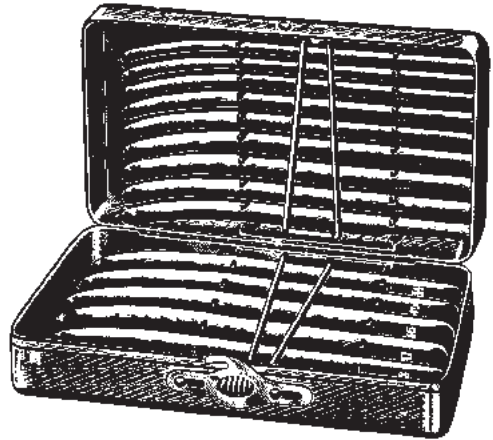

mm HEGAR  
 4-17 71406-14 14 St./pces./pzas./pezzi  
 1-26 71406-26 26 St./pces./pzas./pezzi

71404-14 Satz/Set/Juego/Set  
 71410-04 - 71410-17 = 14  
 71404-26 Satz/Set/Juego/Set  
 71410-01 - 71410-26 = 26

in Metalletui, in metal case,  
 en estuche de metal, in astuccio metallico



**MAST.SH-GERMANY**

Uterus Dilatoren  
Uterine Dilators  
Dilatadores uterinos  
Dilatatori uterini



mm	HEGAR
1/ 2	71420-01
3/ 4	71420-03
5/ 6	71420-05
7/ 8	71420-07
9/10	71420-09
11/12	71420-11
13/14	71420-13
15/16	71420-15
17/18	71420-17
19/20	71420-19
21/22	71420-21
23/24	71420-23
25/26	71420-25

71424-08	Satz/Set/Juego/Set 71420-03 - 71420-17 = 8 3/4 - 17/18 mm
71424-13	Satz/Set/Juego/Set 71420-01 - 71420-25 = 13 1/2 - 25/26 mm

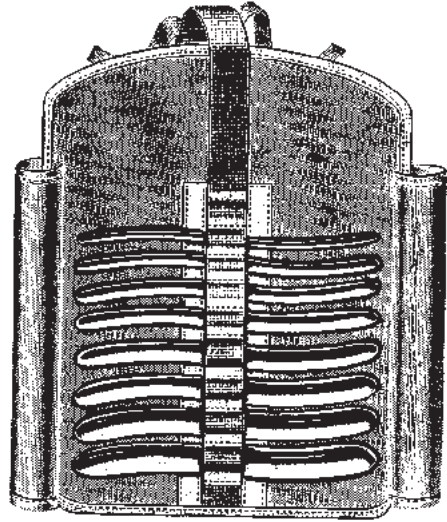

mm	HEGAR	
3/4 - 17/18	71425-08	8 St./pces./pzas./pezzi

in Stofftasche, in khaki roll,  
en bolsa de tela, in borsa di tela

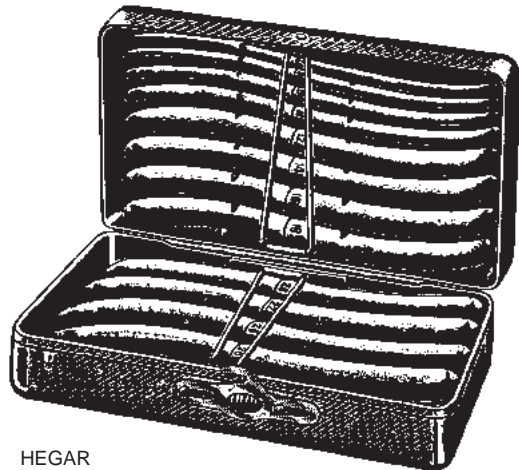

mm	HEGAR	
3-4 - 17/18	71426-08	8 St./pces./pzas./pezzi
1/2 - 25/26	71426-13	13 St./pces./pzas./pezzi

in Metalletui, in metal case,  
en estuche de metal, in astuccio metallico



# MAST.SH-GERMANY

Uterus Dilatatore  
Uterine Dilators  
Dilatadores uterinos  
Dilatatori uterini

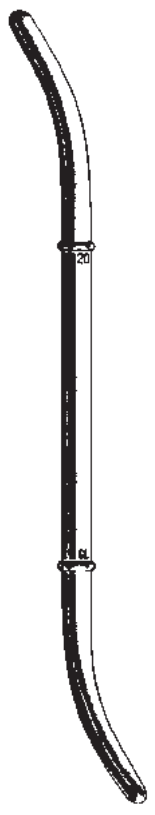

in Stofftasche  
in khaki roll  
en bolsa de tela  
in borsa di tela

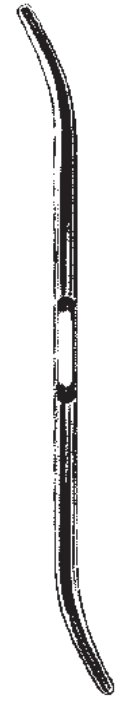
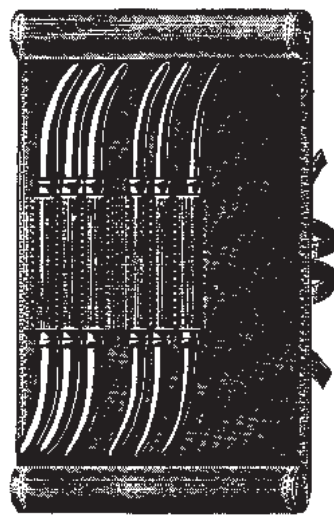

mm	HANK	Fig./U.S.
4,5/ 5	71430-10	9/10
5,5/ 6	71430-12	11/12
6,5/ 7	71430-14	13/14
7,5/ 8	71430-16	15/16
8,5/ 9	71430-18	17/18
9,5/10	71430-20	19/20

71435-06 Satz, Set, Juego, Serie = 6

HANK  
71436-08  
Satz, Set, Juego, Serie = 6

PRATT		
71438-13 - 71438-41		
71438-00		
Satz, Set, Juego, Set = 8		
size	mm	
71438-13	13-15	4,5/ 5,0
71438-17	17-19	5,6/ 6,3
71438-21	21-23	7,0/ 7,6
71438-25	25-27	8,3/ 9,0
71438-29	29-32	9,6/10,3
71438-33	33-35	11,0/11,6
71438-37	37-39	12,3/13,0
71438-41	41-43	13,6/14,3

Uterus Dilatoren  
Uterine Dilators  
Dilatadores uterinos  
Dilatatori uterini

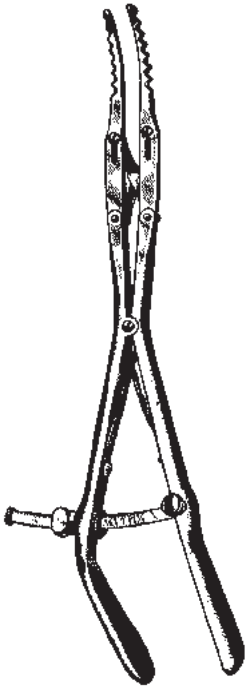

GOODELL  
71441-34  
34 cm, 13 1/2"

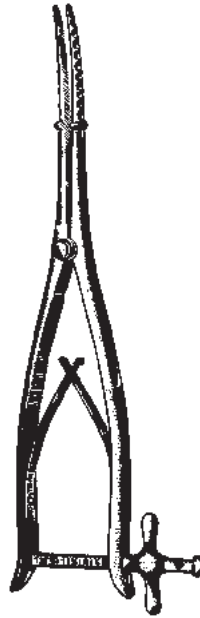

WYLIE  
71443-29  
29 cm, 11 1/2"



SIMS  
71445-29  
29 cm, 11 1/2"



Hakenzangen  
Tenaculum Forceps  
Pinzas para coger el cuello del útero  
Pinze per abbassare il collo dell'utero

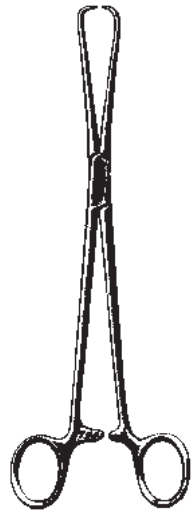

SCHRÖDER (POZZI)  
71502-25  
25 cm, 10"

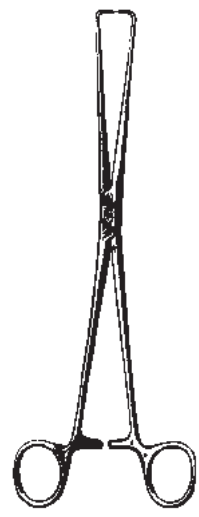

BRAUN  
71504-25  
25 cm, 10"



SKENE  
71505-24  
24 cm, 9 1/2"

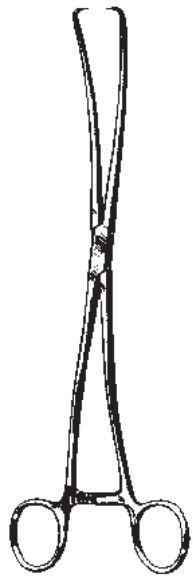

DUPLAY  
71507-28  
28 cm, 11"

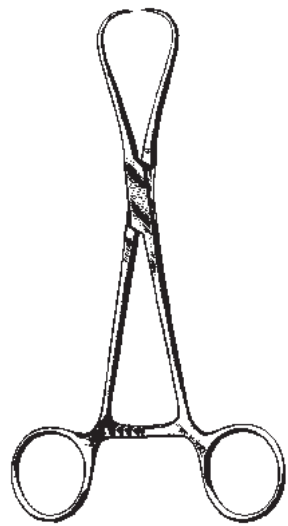

STAUDE-MOORE  
71508-17  
17 cm, 6 3/4"

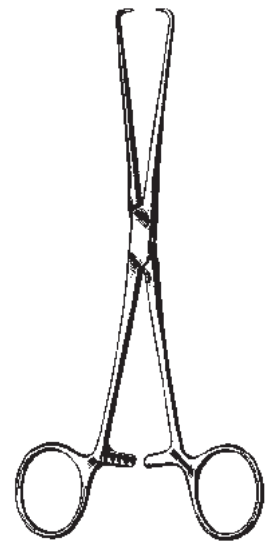

BARRETT  
71510-18  
18 cm, 7"



Hakenzangen  
Tenaculum Forceps, Vulsellum Forceps  
Pinzas para coger el cuello del útero  
Pinze per abbassare il collo dell'utero

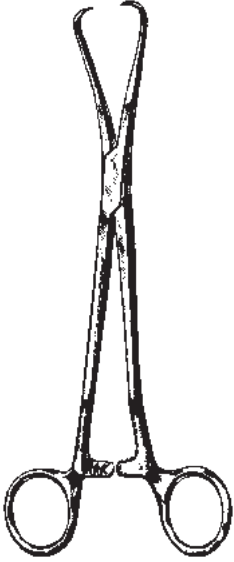

JARCHO  
71512-20  
20 cm, 8"

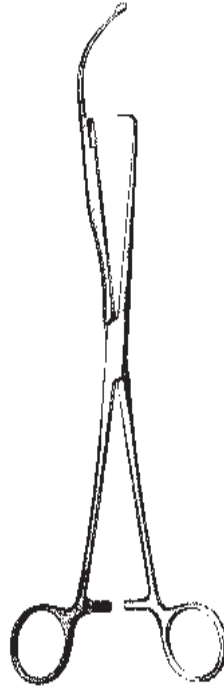

HULKA  
71512-28  
28 cm, 11"

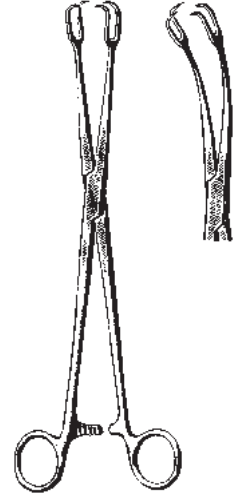

SCHRÖDER  
71514-24 71515-24  
24 cm, 9 1/2"

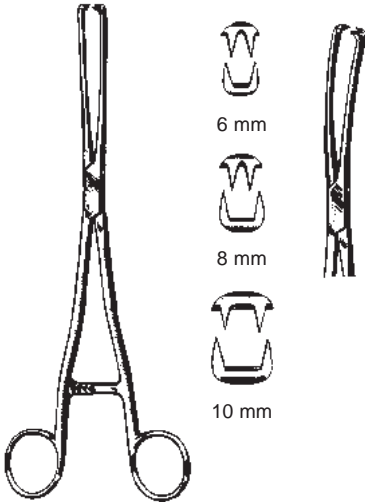

MUSEUX  
71524-06 6 mm 71525-06  
71524-08 8 mm 71525-08  
71524-10 10 mm 71525-10  
24 cm, 9 1/2"

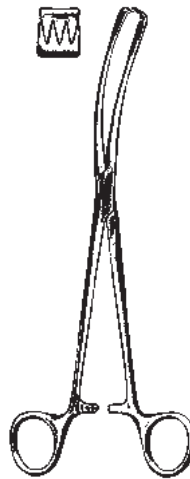

TEALE  
71531-23  
23 cm, 9"

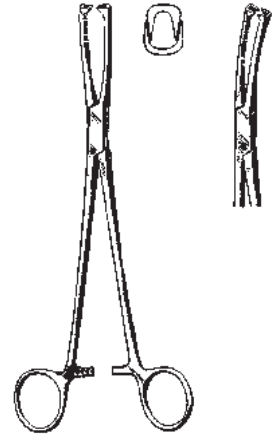

JACOBS  
71532-21 71533-21  
21 cm, 8 1/4"



Hakenzangen  
 Tenaculum Forceps, Vulsellum Forceps  
 Pinzas para coger el cuello del útero  
 Pinze per abbassare il collo dell'utero

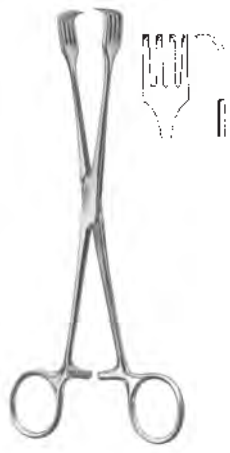

**CZERNY**  
 71536-21  
 20 cm, 8"



**PRATT**  
 71536-28  
 28 cm, 11"



**SCHRÖDER**  
 71537-27  
 27 cm, 10 1/2"



**IOWA**  
 71539-26  
 26 cm, 10 1/4"





Uterus Polypenzangen, Uterus-Faßzangen  
Uterine Polypus Forceps, Uterine Elevating Forceps  
Pinzas para pólipos uterinos, Pinzas para el útero  
Pinze per polipi uterini, Pinze per afferrare l'utero

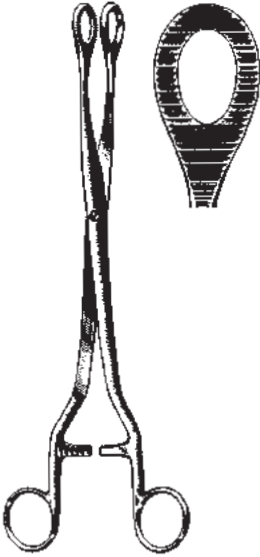

NOTO  
71540-27  
27 cm, 10 1/2"



DOYEN  
71542-20  
20 cm, 8"

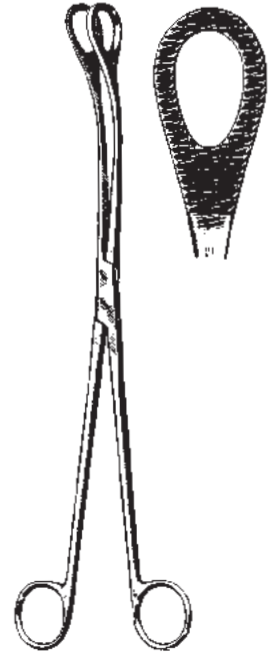

KELLY  
71543-32  
32 cm, 12 3/4"



DARTIGUES  
71545-27  
27 cm, 10 1/2"

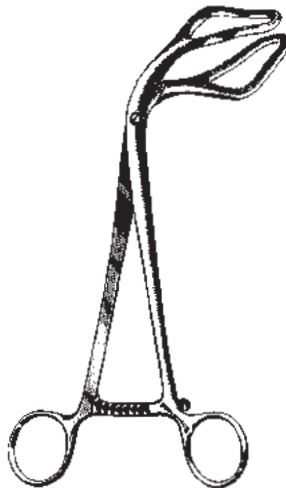

SOMER  
71547-23  
23 cm, 9"

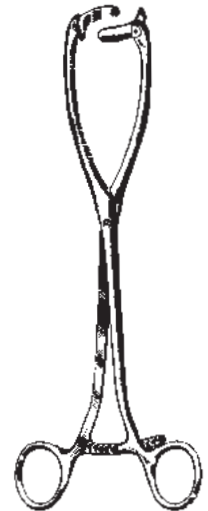

COLLIN  
71549-25  
25 cm, 10"



# MAST.SH-GERMANY

Amniotom, Uterus Depressoren, Uterus-Sonden  
Amniotome, Uterine Depressors, Uterine Sounds  
Amniótomo, Depresores uterinos, Histerómetros  
Amniotomo, Depressori uterini, Isterometri



BEACHAM  
71559-26  
26 cm, 10 1/4"



BRAUN  
71565-28  
28 cm, 11"



SIMS  
71567-26  
26 cm, 10 1/4"



fest  
rigid  
rigido  
rigida  
71580-32  
32 cm, 12 3/4"

biegsam  
malleable  
maleable  
malleabile  
71581-32

SIMS



fest  
rigid  
rigido  
rigida  
71582-32  
32 cm, 12 3/4"

biegsam  
malleable  
maleable  
malleabile  
71583-32

MARTIN



COLLIN  
71584-28  
28 cm, 11"



VALLEIX  
71585-25  
25 cm, 10"

Biopsie-Küretten  
 Uterine Biopsy Aspirating Curettes  
 Curetas aspiradoras p. la biopsia uterina  
 Curette per biopsia

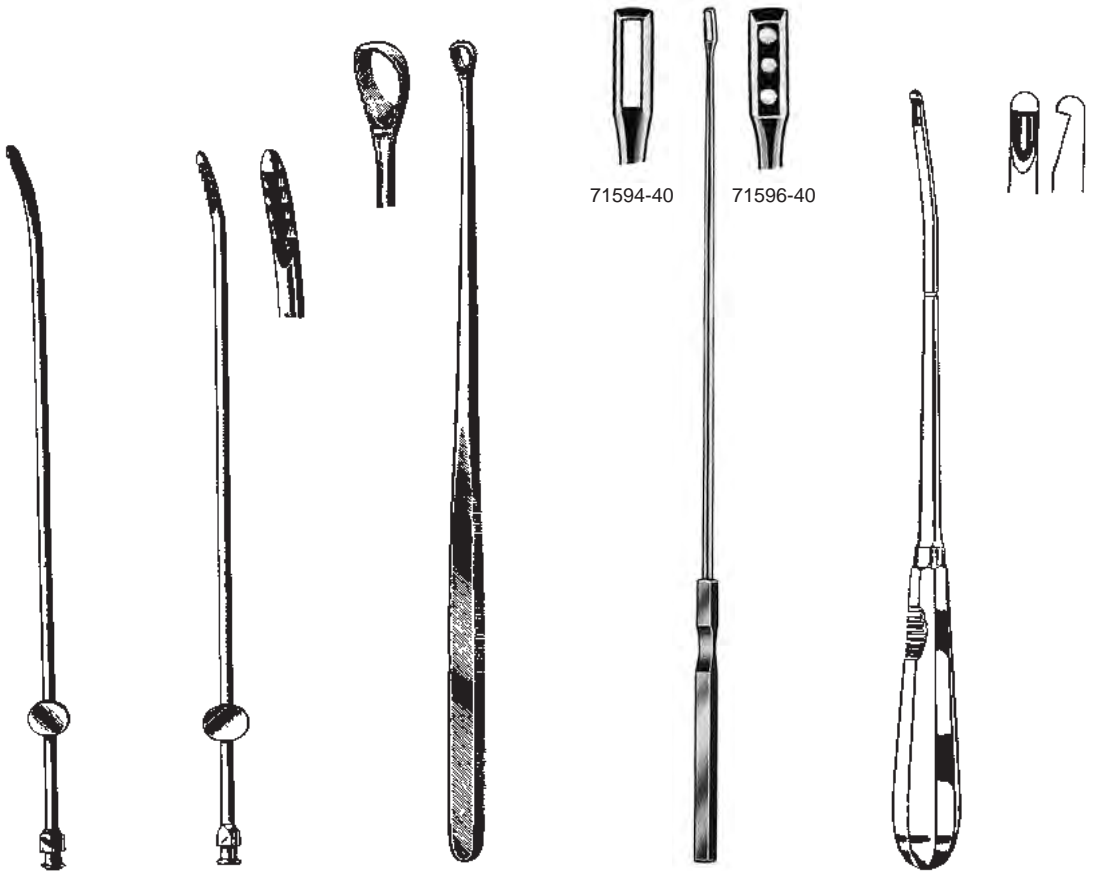

**RANDALL**  
 71590-04  
 24 cm, 9 1/2"  
 Ø 4 mm

**NOVAK**  
 71592-01 1 mm  
 71592-02 2 mm  
 71592-03 3 mm  
 71592-04 4 mm

**HEANY**  
 71593-00  
 22,5 cm, 9"

**KEVORKIAN**  
 4,0 mm  
 30 cm, 11 3/4"

**MOD. MUENCHEN**  
 71598-27  
 27 cm, 10 1/2"  
 ohne Korb  
 without basket  
 sin cesta  
 senza cestello  
 71594-40

mit Korb  
 with basket  
 con cesta  
 con cestello  
 71596-40



# MAST.SH-GERMANY

Biopsiezangen  
 Biopsy Forceps  
 Pinzas para biopsia  
 Pinze taglienti per biopsia

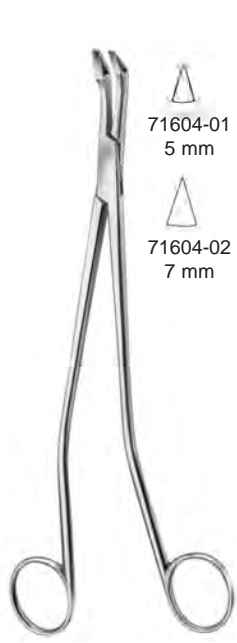

71604-01  
5 mm

71604-02  
7 mm

SCHUMACHER  
24 cm, 9 1/2"



SCHUBERT  
71604-21 21 cm, 8 1/4"  
71604-28 28 cm, 11"

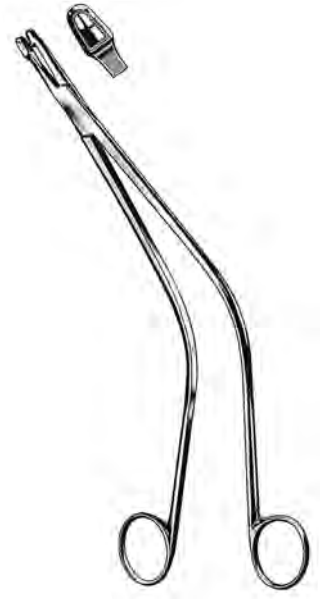

SCHUBERT  
71605-26  
26 cm, 10 1/4"



THOMAS-GAYLOR  
71606-24  
24 cm, 9 1/2"



van DOREN  
71611-25  
25 cm, 10"



FAURE  
71612-21  
21 cm, 8 1/4"



**MAST.SH-GERMANY**

Uterus Biopsiezangen  
Biopsy Specimen Forceps  
Pinzas para biopsia  
Pinze per biopsia

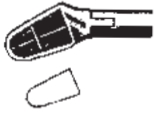

20 cm, 8"

ALEXANDER  
71613-28  
28 cm, 11"

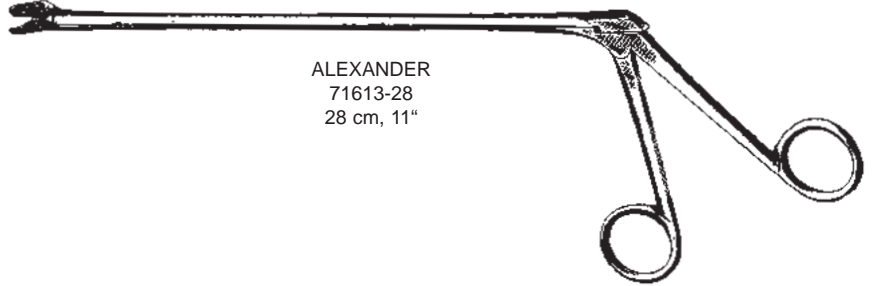

24 cm, 9 1/2"

71615-01  
4 mm

SCHUMACHER  
71615-01 - 71615-02  
24 cm, 9 1/2"

71615-02  
6 mm

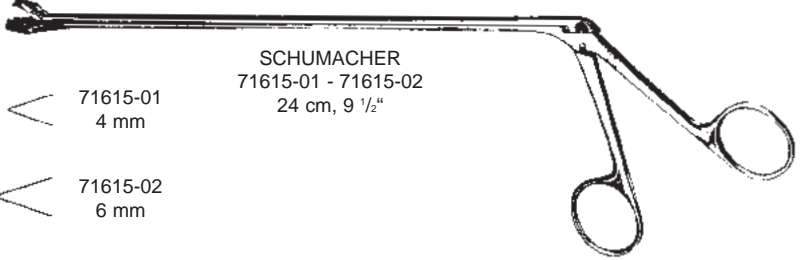

24 cm, 9 1/2"

3x9.7 mm

KEVORKIAN  
71617-04  
24,5 cm, 9 3/4"

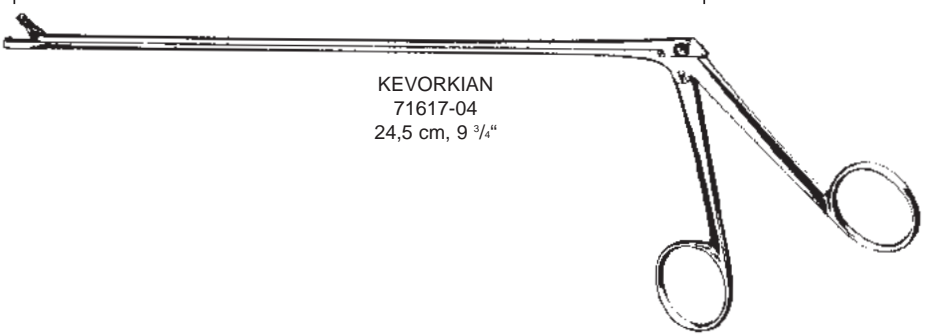

23 cm, 9"

WITTNER  
71618-23 71619-23  
23 cm, 9"

4x8 mm

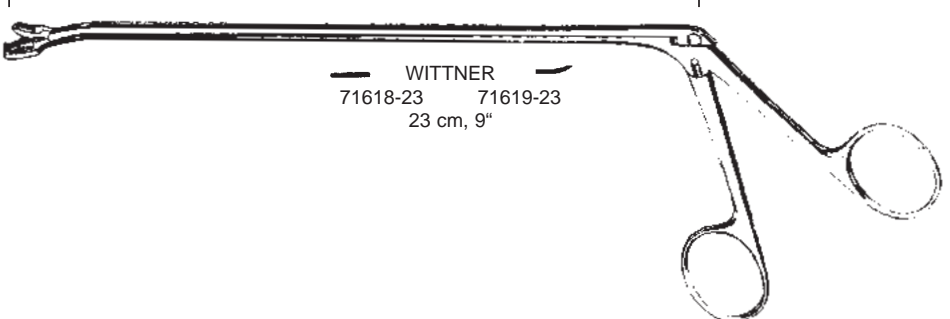



# MAST.SH-GERMANY

Uterus Biopsiezangen  
 Biopsy Specimen Forceps  
 Pinzas sacabocado p. biopsia  
 Pinze per biopsia

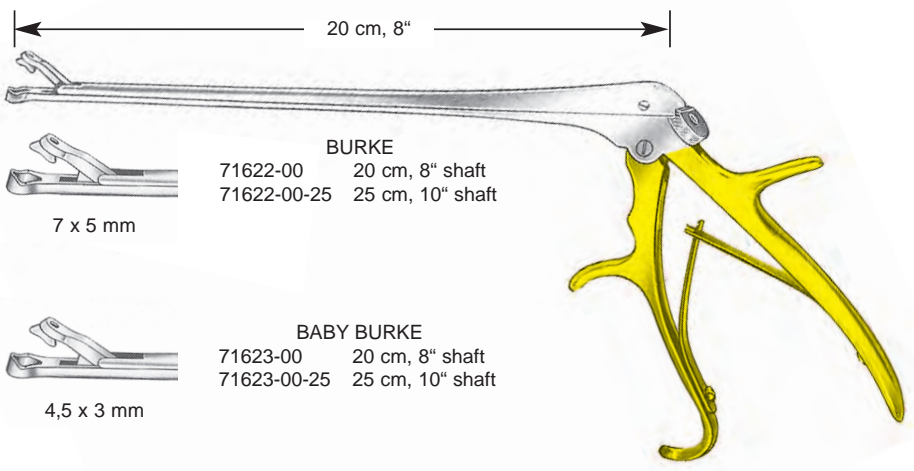
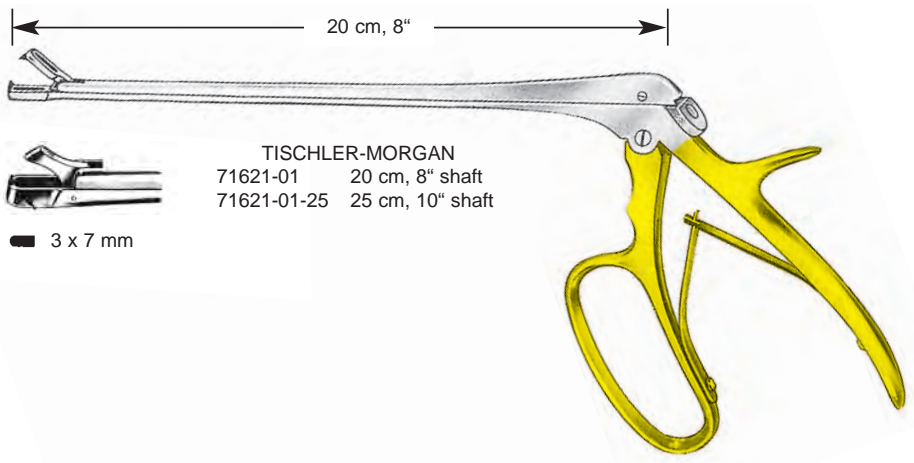
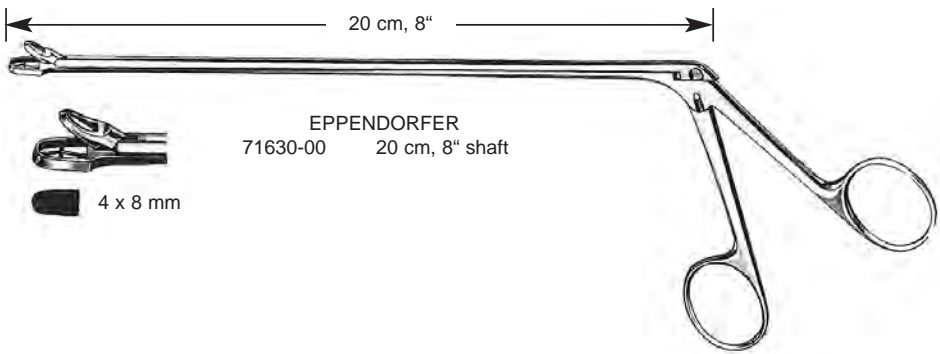



**MAST.SH-GERMANY**

Uterus Biopsiezangen  
 Biopsy Specimen Forceps  
 Pinzas sacabocado p. biopsia  
 Pinze per biopsia

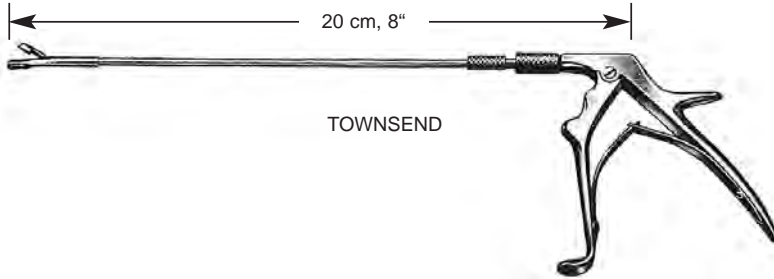

TOWNSEND

71624-10  
 Griff allein  
 Handle only  
 Mango solo  
 Manico solo



Fig. 1

TISCHLER-Morgan



Fig. 6

TISCHLER-UP



Fig. 3

oval ● 3,7x5 mm



Fig. 7

TISCHLER-DOWN



Fig. 4

KEVORKIAN



Fig. 8

MINI-TOWNSEND-UP



Fig. 5

mini



Fig. 9

MINI-TOWNSEND-DOWN

Fig.	Strumento completo	Asta operativa sola
1	71624-01	71624-11
3	71624-03	71624-13
4	71624-04	71624-14
5	71624-05	71624-15
6	71624-06	71624-16
7	71624-07	71624-17
8	71624-08	71624-18
9	71624-09	71624-19

komplett  
 compl. instr.  
 Instrum. compl.

Aufsatz allein  
 Tip only  
 Punta sola

Uterus Biopsiezangen  
 Biopsy Specimen Forceps  
 Pinzas sacabocado p. biopsia  
 Pinze per biopsia

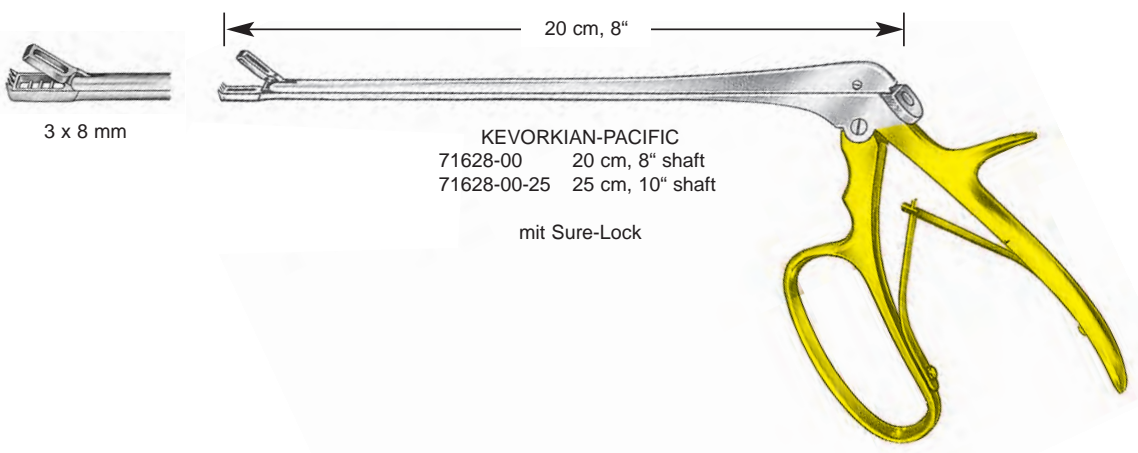
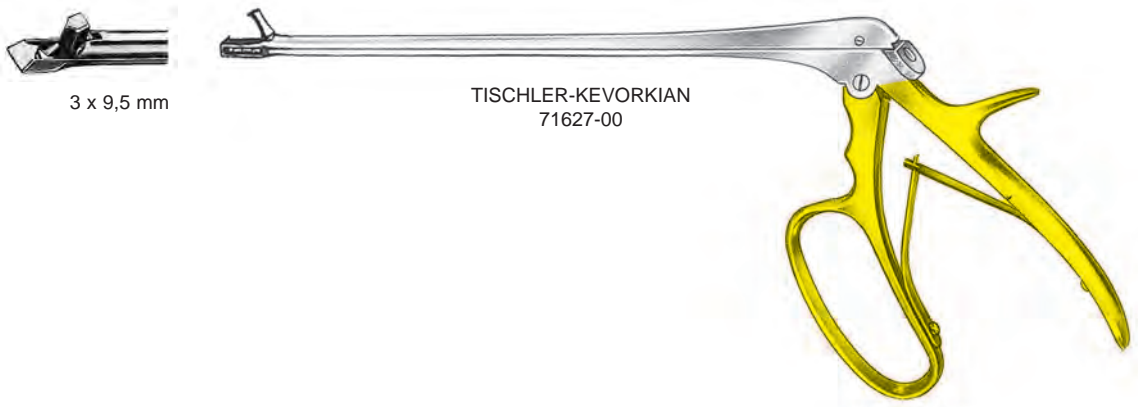
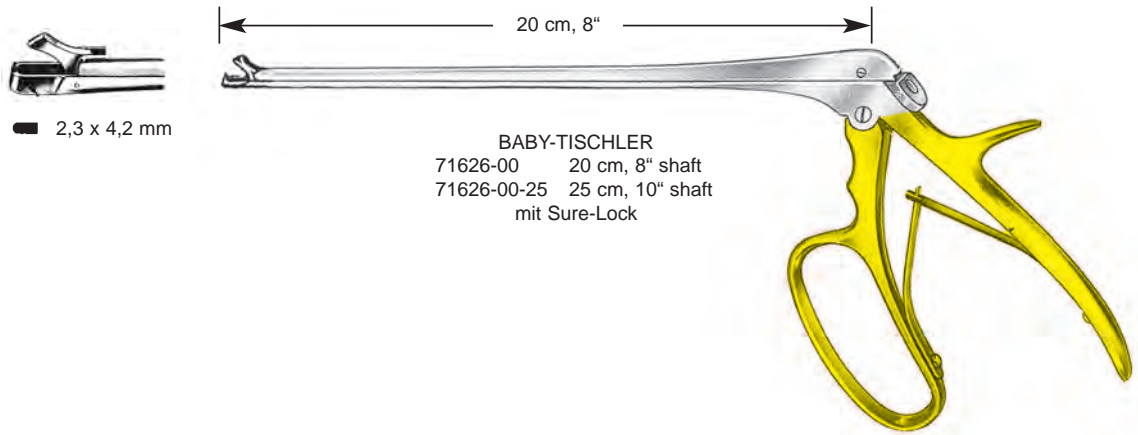





**MAST.SH-GERMANY**

Uterus Biopsiezangen  
Biopsy Specimen Forceps  
Pinzas sacabocado p. biopsia  
Pinze per biopsia

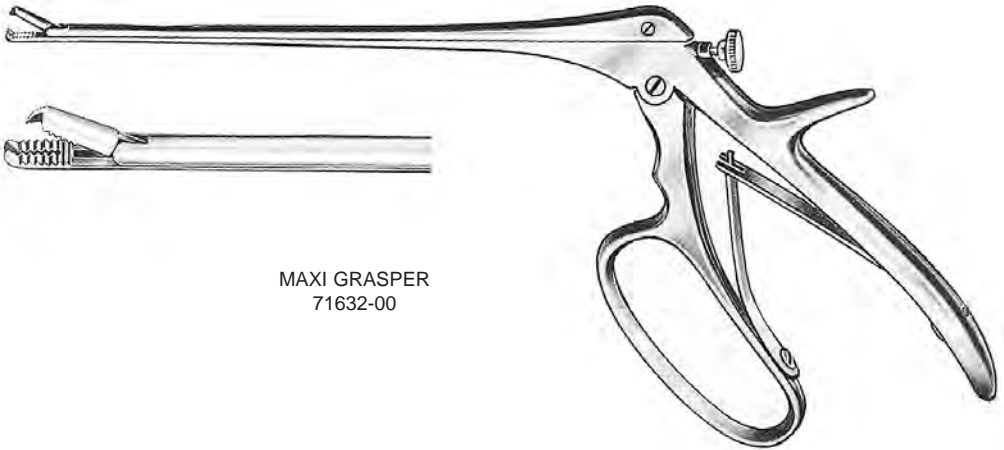

MAXI GRASPER  
71632-00

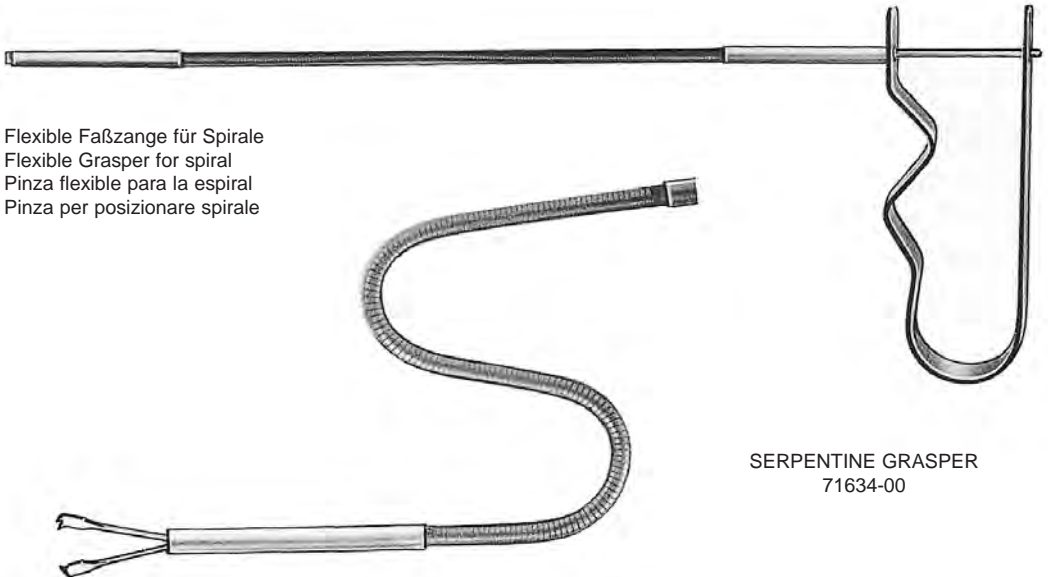

Flexible Faßzange für Spirale  
Flexible Grasper for spiral  
Pinza flexible para la espiral  
Pinza per posizionare spirale

SERPENTINE GRASPER  
71634-00



I.U.D.  
Extractor Hook  
71635-26  
26 cm, 10 1/4"



# MAST.SH-GERMANY

Myomheber, Myommesser, Fistelhäkchen, Meßinstrumente, Uteruslöffel  
 Myoma Screw, Myoma Knife, Fistula Hook, Measuring Instruments, Uterine Curettes  
 Tirabuzón para fibromas, Bisturi para fibromas, Ganchos para fistulas, Instrumental para medir, Curetas uterinas  
 Tiramiomi, Bisturi per fibromi, Uncini per fistole, Strumenti per misure, Curette uterine



**DOYEN**  
 71641-17  
 17 cm, 6 3/4"

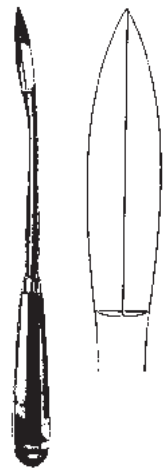

**SEGOND**  
 71643-27  
 27 cm, 10 1/2"

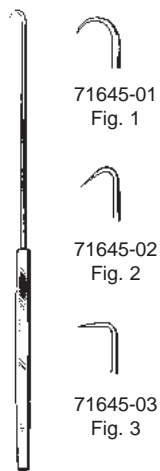

**EMMET**  
 71645-01 - 71645-03  
 22 cm, 8 3/4"

- 71645-01  
Fig. 1
- 71645-02  
Fig. 2
- 71645-03  
Fig. 3

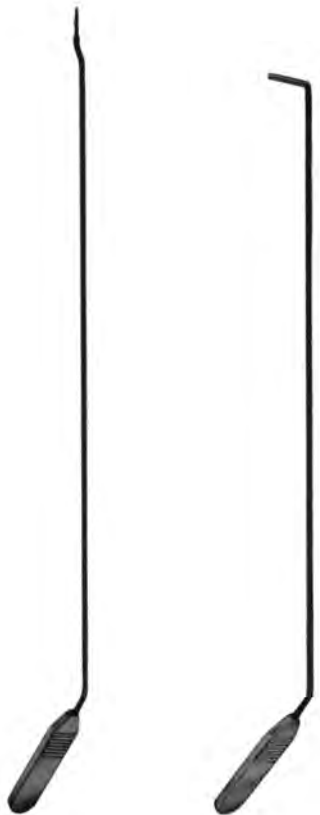

71646-01

71646-02

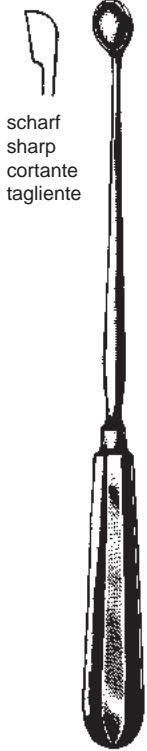

scharf  
 sharp  
 cortante  
 tagliente

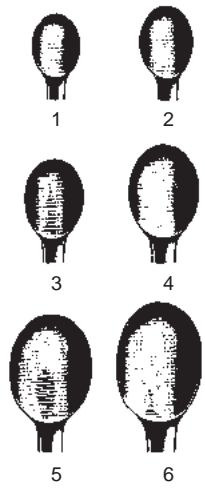

- Fig. SIMON
- |   |          |         |
|---|----------|---------|
| 1 | 71702-01 | 6,8 mm  |
| 2 | 71702-02 | 8,5 mm  |
| 3 | 71702-03 | 10,0 mm |
| 4 | 71702-04 | 11,5 mm |
| 5 | 71702-05 | 13,0 mm |
| 6 | 71702-06 | 14,5 mm |
- 25 cm, 10"



Uterus-Küretten  
Uterine Curettes  
Curetas uterinas  
Curette uterine



SCHRÖDER  
31 cm, 12 1/4"



71703-01  
6,8 mm



71703-02  
8,5 mm



71703-03  
10 mm



71703-04  
11,5 mm



71703-05  
13 mm



71703-06  
14,5 mm

scharf/stumpf  
sharp/blunt  
cortante/roma  
tagliente/smussa

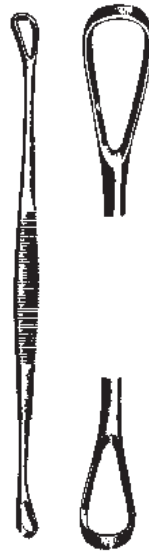

BLAKE  
71704-27  
27 cm, 10 1/2"

Uterus-Küretten  
 Uterine Curettes  
 Curetas uterinas  
 Curette Uterine



**SIMS**  
 71710-05 - 71717-14  
 28 cm, 11"

	scharf sharp cort. tagl.	Fig.	mm	stumpf blunt roma smussa
fest	71710-05	00	5,0	71715-05
rig.	71710-06	0	6,0	71715-06
	71710-07	1	7,5	71715-07
	71710-08	2	8,5	71715-08
	71710-09	3	10,0	71715-09
	71710-11	4	11,5	71715-11
	71710-12	5	13,5	71715-12
	71710-14	6	14,5	71715-14



**RECAMIER**  
 71720-05 - 71727-20  
 31 cm, 12 1/4"

	scharf sharp cort. tagl.	Fig.	mm	stumpf blunt roma smussa
fest	71720-05	00	5	71725-05
rig.	71720-06	0	6	71725-06
	71720-07	1	7	71725-07
	71720-08	2	8	71725-08
	71720-09	3	9	71725-09
	71720-11	4	11	71725-11
	71720-12	5	12	71725-12
	71720-14	6	14	71725-14
	71720-15	7	15	71725-15
	71720-16	8	16	71725-16
	71720-19	9	19	71725-19
	71720-20	10	20	71725-20

flexibel	71712-05	00	5,0	71717-05
flexible	71712-06	0	6,0	71717-06
fless.	71712-07	1	7,5	71717-07
	71712-08	2	8,5	71717-08
	71712-09	3	10,0	71717-09
	71712-11	4	11,5	71717-11
	71712-12	5	13,5	71717-12
	71712-14	6	14,5	71717-14



**BUMM**  
 71730-30 - 71737-40  
 28 cm, 11"

	scharf sharp cort. tagl.	Fig.	stumpf blunt roma smussa
fest	71730-30	14	71735-30
rig.	71730-35	15	71735-35
	71730-40	16	71735-40

flexibel	71732-30	14	71737-30
flexible	71732-35	15	71737-35
fless.	71732-40	16	71737-40

Uterus-Küretten  
 Uterine Curettes  
 Curetas uterinas  
 Curette uterine

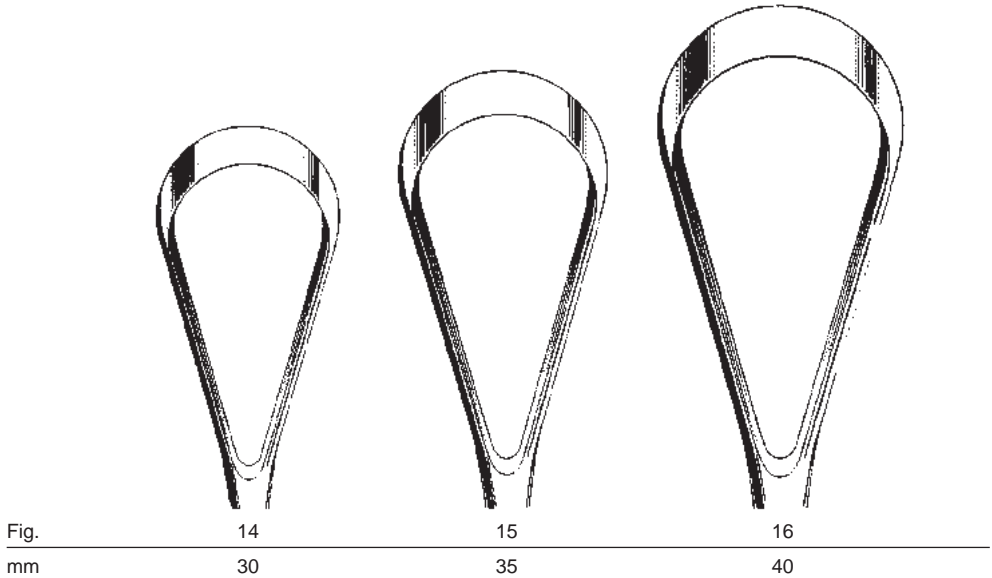
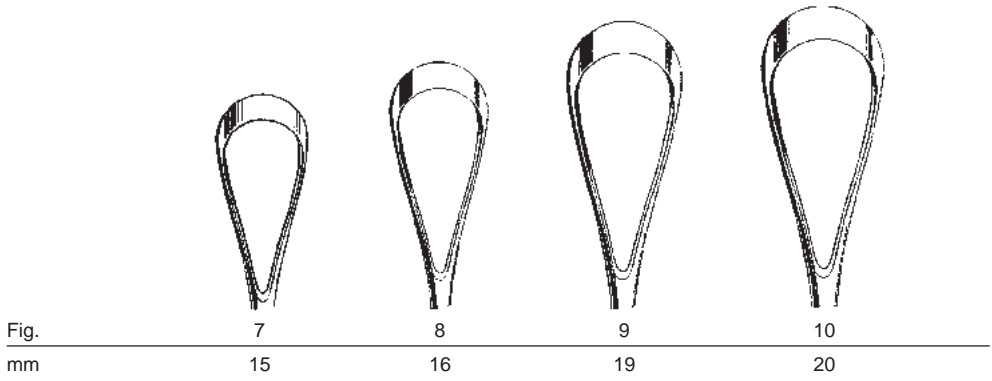
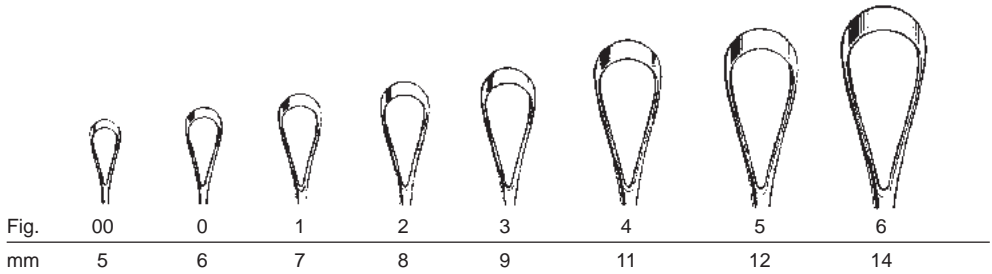

SIMS  
 RECAMIER  
 BUMM  
 71710-05 - 71735-28



Uterus-Küretten  
Uterine Curettes  
Curetas uterinas  
Curette uterine



THOMAS  
28 cm, 11"  
stumpf  
blunt  
roma  
smussa

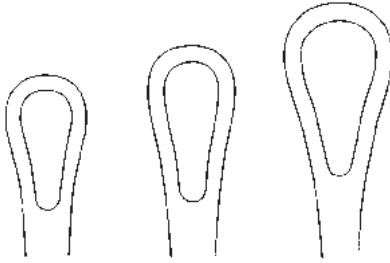

Fig.0  
6 mm  
71736-00

Fig.1  
7 mm  
71736-07

Fig.2  
8 mm  
71736-08



Fig.3  
9 mm  
71736-09



Fig. 4  
10 mm  
71736-10

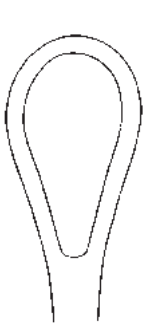

Fig. 5  
11 mm  
71736-11



Fig. 6  
12 mm  
71736-12



GOURDET  
28 cm, 11"



6 mm  
71737-06



8 mm  
71737-08



10 mm  
71737-10



12 mm  
71737-12



14 mm  
71737-14

Biopsie- und Absaugküretten, Schlauch-Verbindungsstück  
 Specimen and Aspirating Curettes, Hose connecting piece  
 Curetas para biopsia y aspiración, Pieza conexión para tubos  
 Curette di aspirazione per biopsia, Raccordo di connessione per tubi

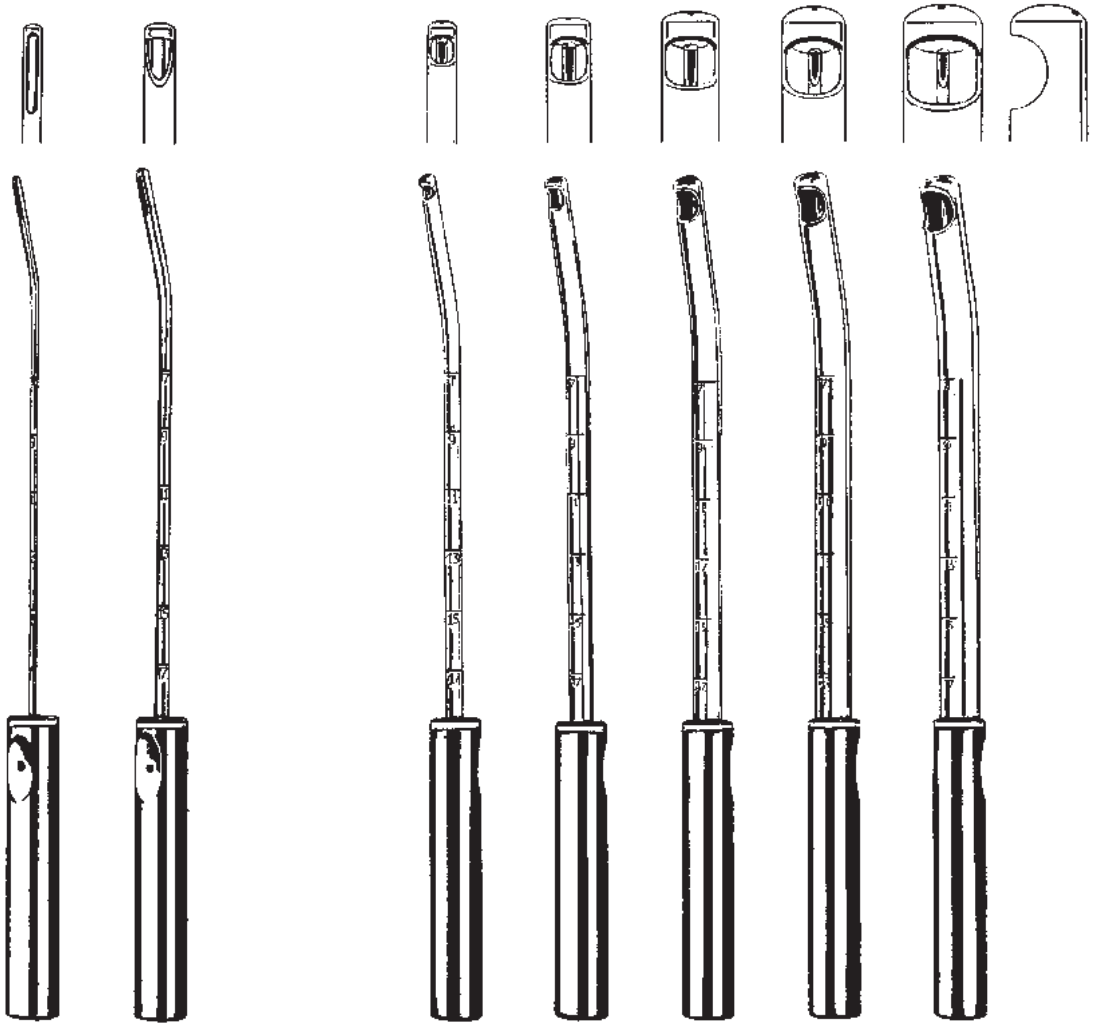

71803-03  
3 mm Ø

71803-04  
4,5 mm Ø

71803-06  
6 mm Ø

71803-08  
8 mm Ø

71803-10  
10 mm Ø

71803-12  
12 mm Ø

71803-14  
14 mm Ø



71803-15

Geburtszangen  
 Obstetrical Forceps  
 Forceps obstétricos  
 Forcipi



WRIGLEY  
 73101-23  
 23 cm, 9"



SIMPSON  
 73102-30  
 30 cm, 11 3/4"

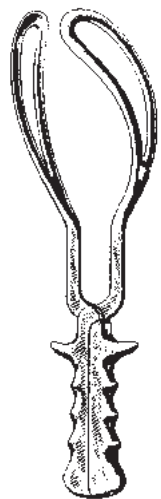

SIMPSON-BRAUN  
 73105-33 33 cm, 13"  
 73105-36 36 cm, 14"



De LEE  
 73107-30  
 30 cm, 11 3/4"



De LEE  
 73108-36 36 cm, 14"  
 73108-39 39 cm, 15 1/2"



KIELLAND  
 73110-41  
 41 cm, 16"



ELLIOT  
 73115-32 32 cm, 12 3/4"  
 73115-38 38 cm, 15"

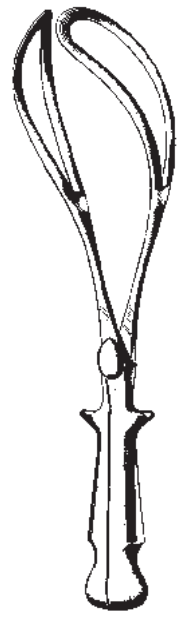

NAEGELE  
 73119-36 36 cm, 14"  
 73119-40 40 cm, 15 3/4"





Geburtszangen  
Obstetrical Forceps  
Forceps obstétricos  
Forcipi

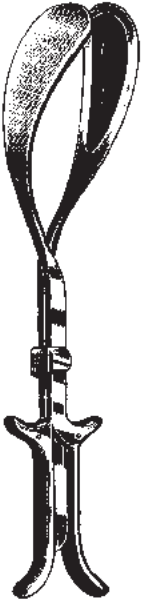

LUIKART  
73125-40  
40 cm, 15 3/4"

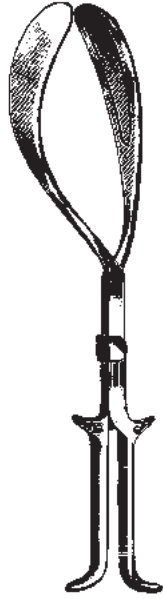

KIELLAND-LUIKART  
73127-40  
40 cm, 15 3/4"



SIMPSON-LUIKART  
73135-36  
36 cm, 14"

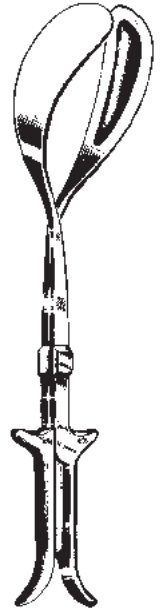

McLEAN-TUCKER-LUIKART  
73139-40  
40 cm, 15 3/4"

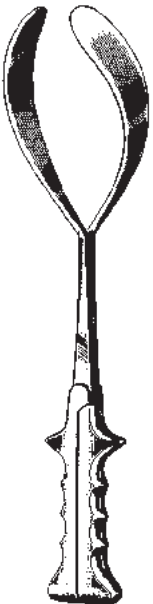

McLEAN-TUCKER  
73141-39  
39 cm, 15 1/2"



McLEAN-LUIKART  
73143-39  
39 cm, 15 1/2"



McLEAN  
73145-36  
36 cm, 14"

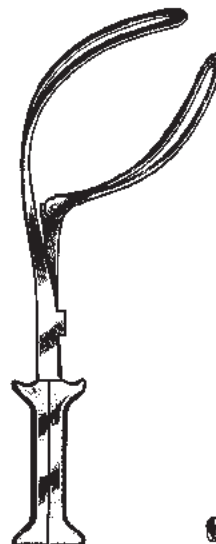

BARTON  
73147-36  
36 cm, 14"

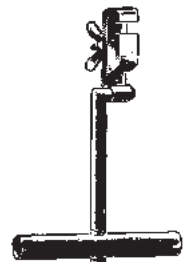

BARTON  
73148-17  
17 cm, 6 3/4"

Geburtszangen, Zughebel  
 Obstetrical Forceps, Traction handles  
 Forceps obstétricos, Dispositivos de tracción  
 Forcipi, Leve per trazione

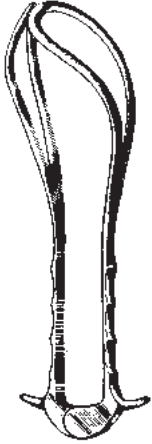

BOERMA  
 73151-29  
 29 cm, 11 1/2"

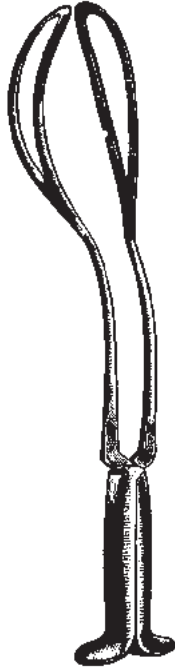

PIPER  
 73155-44  
 44 cm, 17 1/4"

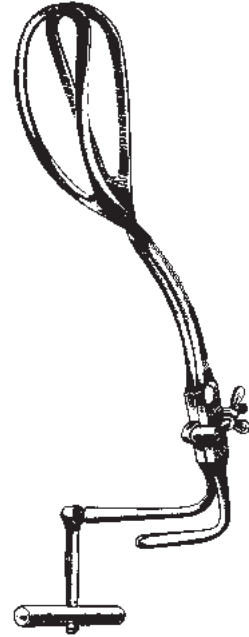

PIPER  
 73157-40  
 40 cm, 15 3/4"

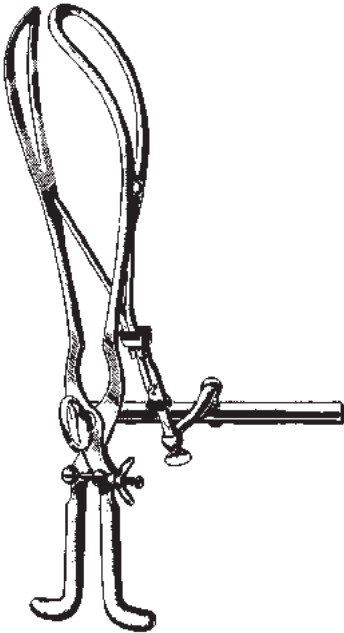

TARNIER  
 40

73162-40  
 cm, 15 3/4"



BILL  
 73170-00  
 21 cm, 8 1/4"

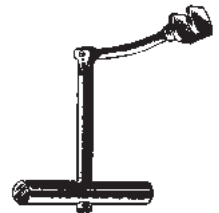

LUIKART-BILL  
 73171-21  
 21 cm, 8 1/4"

Haken, Kopfschwartzangen, Uterus-Klemmzange, Nabelschnurklemmen, Beckenzirkel  
 Scalp flap forceps, Uterine haemostatic forceps, Umbilical cord clamps, Pelvimeters  
 Pinzas para cuero cabelludo, Pinzas-clamps uterinas para hemóstasis, Clamp umbilical, Pelvímetros  
 Pinza per il cuoio capelluto, Pinza uterina, Pinza ombelicale, Pelvimetri



**SPELLIE**  
 73181-33  
 33 cm, 13"

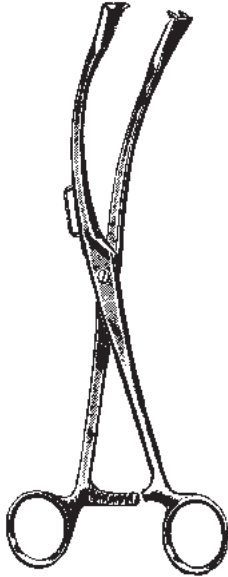

**GAUSS**  
 73183-27  
 27 cm, 10 1/2"

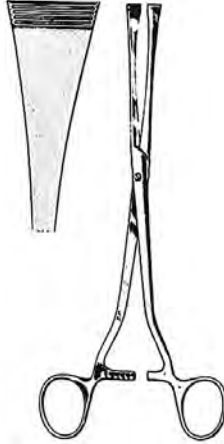

**GREEN-ARMYTAGE**  
 73184-21  
 21 cm, 8 1/4"



**COLLIN**  
 73187-09  
 9 cm, 3 1/2"

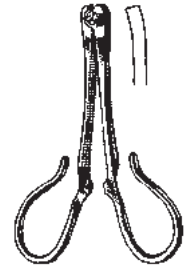

**KANE**  
 73189-09  
 8,5 cm, 3 1/4"

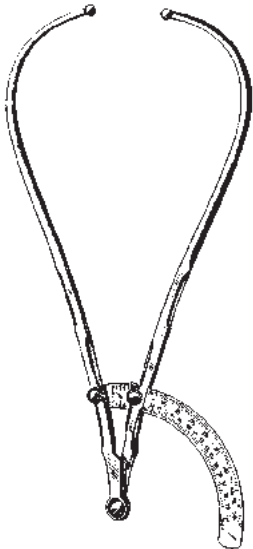

**MARTIN**  
 73191-34  
 34 cm, 13 1/2"

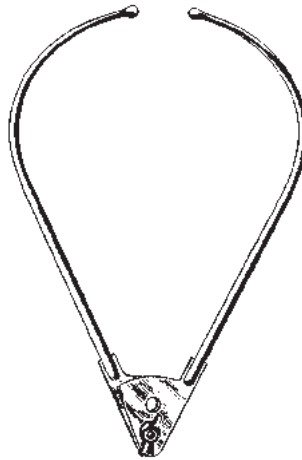

**COLLIER**  
 73193-30  
 30 cm, 11 3/4"

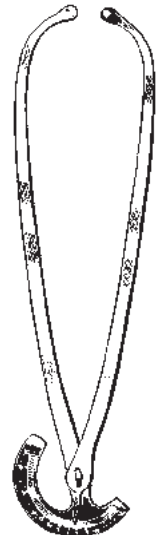

**COLLIN**  
 73195-35  
 35 cm, 14"



# MAST.SH-GERMANY

Abortuszangen, Abortuslöffel  
Ovum Forceps, Abortion Scoops  
Pinzas para aborto, Cucharillas para aborto  
Ostetricia, Curette per aborto



SAENGER  
73242-27 73243-27  
27 cm, 10 1/2"

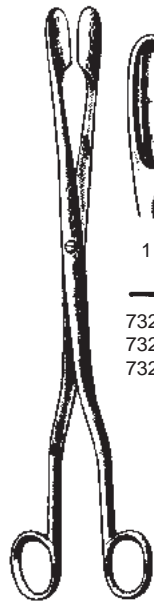

WINTER  
73244-01 - 73245-03  
28 cm, 11"

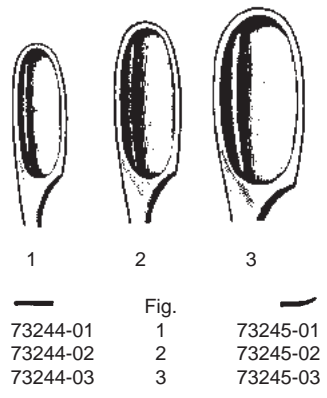
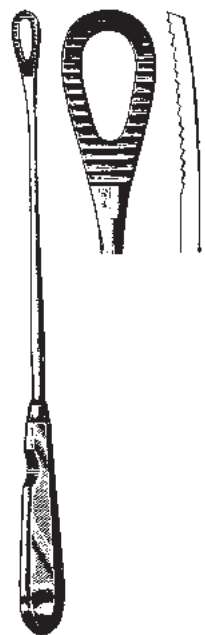

Fig.  
1 73245-01  
2 73245-02  
3 73245-03



PESTALOZZA  
73252-30  
30 cm, 11 3/4"



CUZZI  
73254-14 - 73254-21  
30 cm, 11 3/4"



73254-14  
14,5 mm



73254-18  
18 mm



73254-21  
21 mm

Abortuslöffel, Geburtslöffel, Kranioklast, Basiotrip, Perforatorie, Dekapitationshaken  
 Abortion Scoops, Elevating Spoon, Cranioclast, Basiotribe, Perforators, Decapitating hook  
 Cucharillas para aborto, Separador obstetrico, Craneoclasto, Basiotribo, Perforacráneos, Gancho para decapitación  
 Curette per aborto, Cucchiaio Ostetrico, cranioclasto, Basiotribo, spezzacrani, Uncino per decapitazione



stumpf  
blunt  
roma  
smussa



WALLICH  
73256-42  
42 cm, 16 1/2"



SELLHEIM  
73259-28  
28 cm, 11"

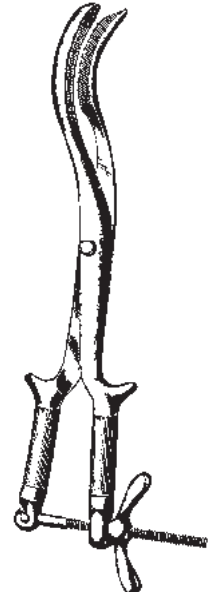

BRAUN  
73302-42  
42 cm, 16 1/2"

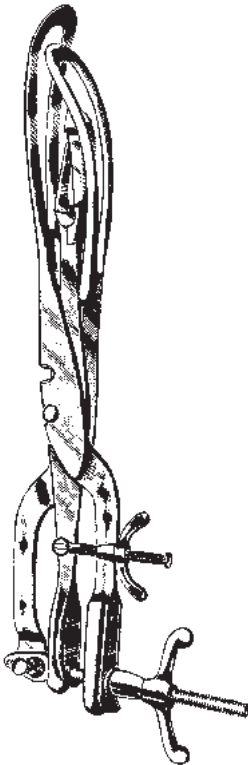

TARNIER  
73304-46  
46 cm, 18"

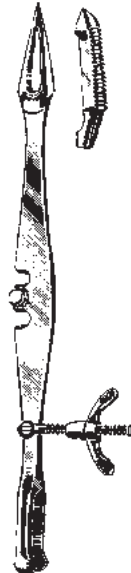

SMELLIE  
73306-25  
25 cm, 10"



BRAUN  
73309-30  
30 cm, 11 3/4"



# MAST.SH-GERMANY

Hauthäkchen, Komedonenquetscher, Lupusküretten, Hautküretten, Haut-Trephinen  
 Skin hooks, Comedone extractors, Lupus curettes, Skin curettes, Cutaneous punches  
 Ganchos cutáneos, Saca comedones, Curetas para lupus, Curetas cutáneas, Trépanos cutáneos  
 Uncini cutanei, Schiaccia comedoni, Curette per lupus, Curette cutanee, Trefine cutanee



**KILNER**  
75103-15  
15 cm, 6"



**SCHAMBERG**  
75111-10  
10 cm, 4"



**UNNA**  
75113-14  
14 cm, 5 1/2"



**UNNA**  
75115-14  
14 cm, 5 1/2"



**WALTON**  
75118-14  
14 cm, 5 1/2"



**SAALFELD**  
75121-10  
10 cm, 4"

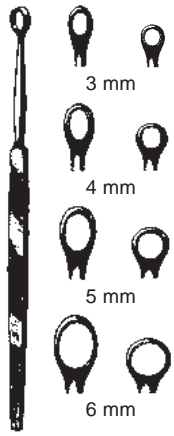

14 cm, 5 1/2"

FOX		FOX	
75128-01	1 mm	75129-01	1 mm
75128-02	2 mm	75129-02	2 mm
75128-03	3 mm	75129-03	3 mm
75128-04	4 mm	75129-04	4 mm
75128-05	5 mm	75129-05	5 mm
75128-06	6 mm	75129-06	6 mm



**PIFFARD**  
14,5 cm, 5 3/4"  
75130-01 Fig. 1  
75130-02 Fig. 2  
75130-03 Fig. 3

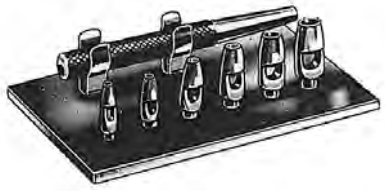

**75138-00**  
Satz komplett mit 6 Aufsätzen  
Set complete with 6 tips  
Juego con 6 puntas  
Serie completa con 6 trefini



**KEYES**  
10 cm, 4"  
75140-02 2 mm  
75140-03 3 mm  
75140-04 4 mm  
75140-05 5 mm  
75140-06 6 mm  
75140-07 7 mm  
75140-08 8 mm

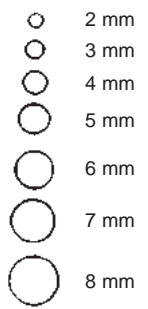



**MAST.SH-GERMANY**

Nagelzangen, -Scheren  
Nail Nippers, Scissors  
Alicates corta-uñas  
Tronchesini forbici per unghie



75301-10

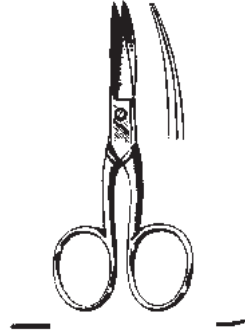

75304-10 10 cm, 4" 75305-10



75331-14  
14 cm, 5 1/2"  
stainless



TURNBULL  
75341-11 11,5 cm, 4 1/2"  
75341-13 13,5 cm, 5 1/4"  
stainless

Nagelhautzangen, Hautscheren, Nagelfeilen  
 Cuticle Nippers, Cuticle Scissors, Nail Files  
 Pinzas y Tjeras cuticulares, Limas para uñas  
 Tronchesine per unghie e pelle, Limette per le unghie



75373-10  
 10,5 cm, 4"



75378-10  
 10 cm, 4"

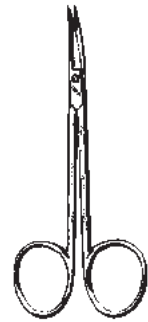

75379-10  
 10 cm, 4"



75382-16



75386-10 10 cm, 4"  
 75386-12 12 cm, 4 3/4"





Hygiene  
Hygiene  
Higiene  
Igiene



PROBE AND PACKER  
75450-00  
14,5 cm, 5 3/4"



SPATULA AND PACKER  
75440-00  
14,5 cm, 5 3/4"



mit Loch, with hole,  
con agujero, con foro

75430-12 = 1,5 mm + 2 mm  
75430-13 = 1,5 mm + 2,5 mm  
14,5 cm, 5 3/4"



14,5 cm, 5 3/4"  
ohne Loch, without hole,  
sin agujero, senza foro

75400-01 = 1 mm  
75400-02 = 1,5 mm  
75400-03 = 2 mm  
75400-04 = 2,5 mm

mit Loch, with hole,  
con agujero, con foro

75410-01 = 1 mm  
75410-02 = 1,5 mm  
75410-03 = 2 mm  
75410-04 = 2,5 mm

Hygiene  
Hygiene  
Higiene  
Igiene

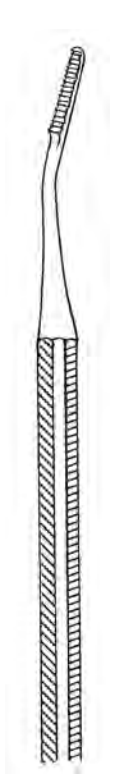

75420-15  
15 cm, 6"

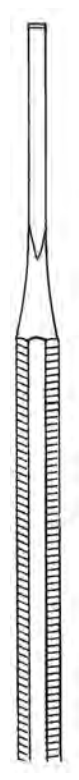

75430-01  
12,5 cm, 5"

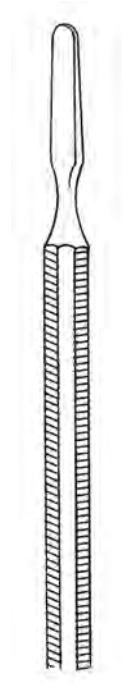

75440-11  
11,5 cm, 4 1/2"

Nagelzangen  
 Nail Nippers  
 Alicates corta-uñas  
 Tronchesini per unghie

stainless steel

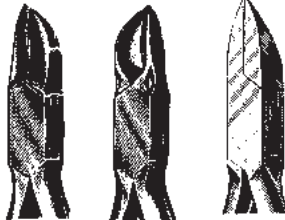

75450-13  
 concave

75460-13  
 gerade  
 straight  
 recto  
 retta



75450-13 - 75460-13  
 13 cm, 5 1/8"

stainless steel



75470-11  
 10 cm  
 4"



75475-11  
 11,5 cm  
 4 1/2"



75480-13  
 12,5 cm  
 5"



fine  
 75485-13  
 12,5 cm  
 5"



75490-15  
 15 cm  
 6"



fine  
 75500-15  
 15 cm  
 6"

Nagelzangen  
 Nail Nippers  
 Alicates corta-uñas  
 Tronchesini per unghie

stainless steel

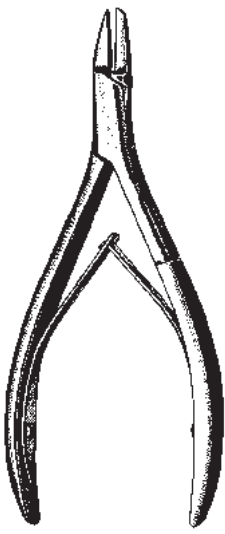

ANVIL  
 75550-13  
 13 cm, 5 1/8"

stainless steel

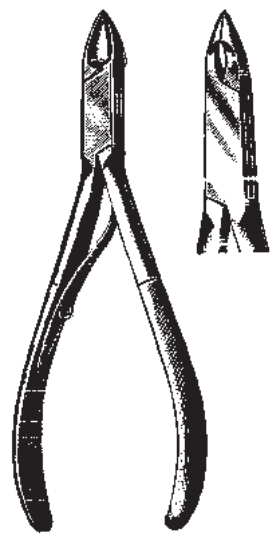

75600-10  
 10 cm, 4"

stainless steel



75618-15  
 15,2 cm, 6"

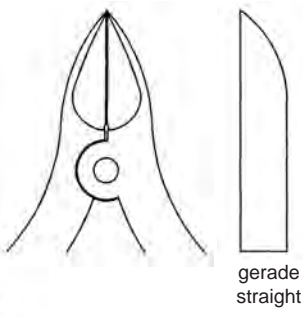

stainless steel

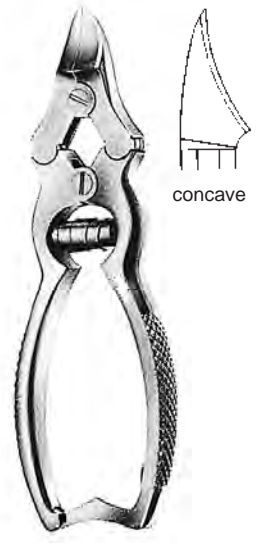

75620-15  
 15,5 cm, 6"



Nagelzangen, Nagelscheren  
Nail Nippers, Nail scissors  
Alicates corta-uñas, Tijeras para uñas  
Tronchesini per unghie, Forbici per unghie



75630-12  
12 cm, 4<sup>3</sup>/<sub>4</sub>"



75640-15  
15 cm, 6"

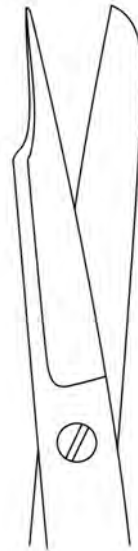

Nagelspaltscheren  
Nail splitting scissors  
Tijeras para hender uñas  
Forbici per staccare unghie



Nadel-Sterilisierkästen, Kappenzangen  
Needle Sterilizing cases, Sterilizing Forceps  
Estuches para esterilizar agujas, Combinacion tapa-pinza  
Scatole per sterilizzare aghi, Pinza coperchio

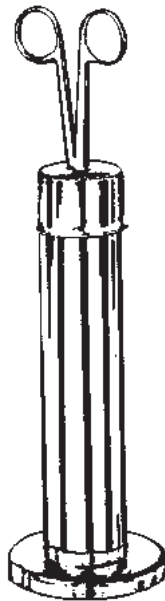

89111-25 25 cm, 10"  
89111-32 32 cm, 12 3/4"



89112-65  
65 x 15 mm



89113-65



89114-00  
150 x 95 x 13 mm



89115-50 50 x 25 x 4,5 mm  
89115-65 65 x 42 x 8,0 mm  
89115-75 75 x 25 x 4,5 mm



89116-50 50 x 25 x 4,5 mm  
89116-65 65 x 42 x 8,0 mm  
89116-75 75 x 25 x 4,5 mm

Sterilisierkästen  
Sterilizing Cases  
Cajas para esterilización  
Scatole per sterilizzazione



89117-20 200 x 100 x 25 mm  
89117-23 230 x 130 x 25 mm  
89117-27 275 x 230 x 25 mm

Sterilisier-Behälter mit Silikonmatte  
Micro instrument tray with silicone mat  
Caja para instrumental micro-quirurgico con alfombrilla de silicona  
Scatola per sterilizzazione con stuoia in silicone

89118-20  
89118-23  
89118-27

Silikonmatte  
Silicone mat  
Alfombrilla de silicona  
Stuoia in silicone

Instrumentenkästen  
Instrument Boxes  
Cajas para instrumentos  
Scatole per strumenti



Abmessungen in mm Sizes in mm tamaños en mm misura in mm	ohne Knopfdeckel lid without knob tapa sin botón coperchio senza bottone
l x b x h mm	
165x 85x35	89122-16
200x100x50	89122-21
260x150x50	89122-26
310x200x50	89122-30



Sterilisierkästen  
 Sterilizing Cases  
 Cajas para esterilización  
 Scatole per sterilizzazione

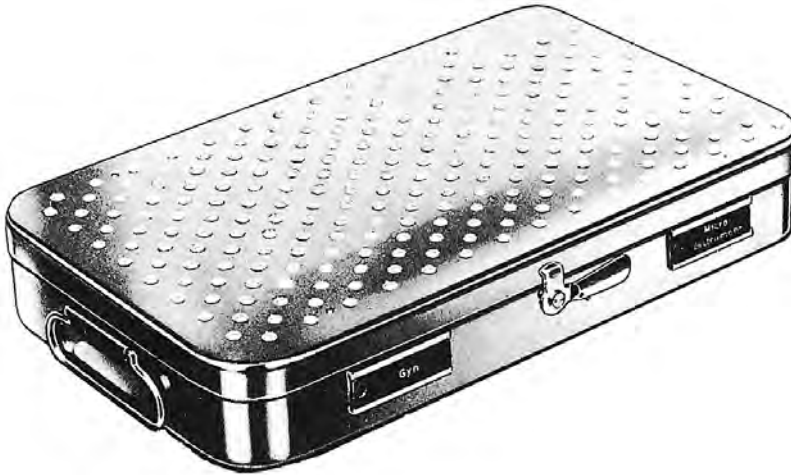

Abmessungen in mm (l x b x h)

Sizes in mm (l x b x h)

tamaños en mm (l x f x a)

misura in mm (l x l x a)

230 x 130 x 50

260 x 150 x 50

275 x 235 x 50

300 x 200 x 50

325 x 275 x 50

420 x 175 x 50

230 x 130 x 75

260 x 150 x 75

300 x 200 x 75

325 x 275 x 75

420 x 175 x 75

Behälter

Containers

Recipientes

Recipienti

89124-23

89124-26

89124-27

89124-30

89124-32

89124-42

89125-23

89125-26

89125-30

89125-32

89125-42

Satz Spezialfilter (5 Paar)

Set of spezial filters (5 pairs)

Juego de filtros especiales (5 pares)

Set die 5 paia di filtri speciali

89126-23

89126-26

89126-27

89126-30

89126-32

89126-42

89127-23

89127-26

89127-30

89127-32

89127-42



Schalen  
Trays  
Bandejas  
Bacinelle

18/10  
Stainless Steel  
Acero inoxidable  
Acciajo inossidabile

matt  
satin finish  
pulidas mate  
opaco



Abmessungen in mm sizes in mm Tamaños en mm misura in mm Ø x h	Inhalt capacity capacidad capacità l	
40x19	0,05	89127-04
61x30	0,07	89127-06
80x40	0,14	89127-08
116x50	0,35	89127-11
128x55	0,45	89127-12
147x65	0,70	89127-14
167x75	1,10	89127-16
187x85	1,60	89127-18



Abmessungen in mm sizes in mm Tamaños en mm misura in mm Ø x h	Inhalt capacity capacidad capacità l	
110x28	0,15	89129-11



	mm x mm	l
89133-16	165 x 60	0,75
89133-17	175 x 70	1,00
89133-22	220 x 80	2,00
89133-24	240 x 110	3,00
89133-25	255 x 115	4,00
89133-31	310 x 120	6,00
89133-34	345 x 125	8,50
89133-38	380 x 130	11,00



89139-17	170 x 100 x 35 mm	0,50 l
89139-25	250 x 140 x 40 mm	1,25 l
89139-27	275 x 150 x 45 mm	2,25 l

Meßbecher, Dose, Standgefäß, Mehrzweckschalen  
 Graduated Measures, Box, Jars, Universal Trays  
 Copas graduadas, Recipientes, Tarros, Bandejas para instrumentos  
 Bicchieri graduati, Recipienti, Recipienti cilindrici, Bacinelle per strumenti

18/10  
 Stainless Steel  
 Acero inoxidable  
 Acciajo inossidabile

matt  
 satin finish  
 pulidas mate  
 opaco



l	
0,25	89140-02
0,5	89140-05
1,0	89140-10
2,0	89140-20



89141-10  
 100 x 20 mm



	mmxmm
89142-01	30x 90
89142-02	50x100
89142-03	50x130
89142-04	50x175
89142-05	75x100
89142-06	75x130
89142-07	75x175



89147-21 - 89147-42

	l x b x h
89147-21	210x160x10 mm
89147-24	240x180x10 mm
89147-30	310x150x10 mm
89147-31	310x210x10 mm
89147-35	350x240x10 mm
89147-40	400x270x20 mm
89147-42	420x280x10 mm



89145-23 - 89145-40

	l x b x h
89145-23	230x155x30 mm
89145-30	300x175x30 mm
89145-31	300x175x40 mm
89145-35	350x240x36 mm

Medizinlöffel, -becher, Tablettenschale, Sputumbecher, Stechbecken, Plazentabecken  
 Medicine Spoon and Cups, Trays for tablets, Sputum Cup, Bed Pan, Placenta Pan  
 Cuchara graduada, Vasos graduados, Platos para tabletas, Escupidera, Silleta, Cubeta para placenta  
 Cucchiaino per medicinali, bicchieri per medicinali, Bacinelle per compresse, Sputacchiera, Padella, bacinella per placenta



89146-20 20 cc  
110 x 20 mm



89147-10 100 cc  
89147-25 250 cc



89148-25 25 cc  
89148-50 50 cc



89148-31  
ø 310 mm



89148-32



89148-35  
350 x 290 x 90 mm



89149-13 110 x 13 mm  
89149-20 95 x 20 mm



89150-30  
90 x 80 mm

Verbandstofftrommel, Sterilisiersiebschalen  
 Sterilizing Drums, Sterilization Trays  
 Tambores p. esterilización, Cestas de esterilización  
 Tamburi p. sterilizzazione, Cestelli per sterilizzazione



SCHIMMELBUSCH

	Ø
	mmxmm
89152-08	125x 80
89152-10	125x100
89152-12	125x125
89155-08	150x 80
89155-10	150x100
89155-13	150x130
89155-15	150x150
89155-19	150x190
89159-14	190x145
89159-16	190x165
89159-19	190x190
89159-24	190x240
89164-14	240x145
89164-16	240x165
89164-19	240x190
89164-24	240x240
89164-29	240x290
89164-34	240x340
89164-39	240x390
89169-14	290x145
89169-16	290x165
89169-19	290x190
89169-24	290x240
89169-29	290x290
89169-34	290x340
89169-39	290x390
89174-14	340x145
89174-16	340x165
89174-19	340x190
89174-24	340x240
89174-29	340x290
89174-34	340x340
89174-39	340x390
89179-14	390x145
89179-16	390x165
89179-19	390x190
89179-24	390x240
89179-29	390x290
89179-34	390x340
89179-39	390x390
89179-49	390x490
89179-59	390x590

18/10  
 Stainless Steel  
 Acero inoxidable  
 Acciajo inossidabile  
 Acciaio inossidabile

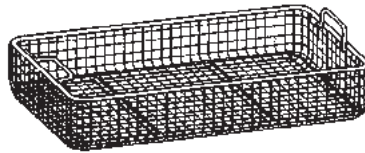

R390.03	255x245x 30 mm
R390.05	255x245x 50 mm
R390.07	255x245x 70 mm
R390.10	255x245x100 mm
R190.03	485x255x 30 mm
R190.05	485x255x 50 mm
R190.07	485x255x 70 mm
R190.10	485x255x100 mm
R191.03	540x255x 30 mm
R191.05	540x255x 50 mm
R191.07	540x255x 70 mm
R191.10	540x255x100 mm

Siebschalen, Endoskopiekorb  
 Trays  
 Bandejas  
 Cestelli

Aus perforiertem Blech  
 From Perforated Sheet Metal  
 De chapa de acero perforada  
 In acciaio perforato

18/10  
 Stainless Steel  
 Acero inoxidable  
 Acciaio inossidabile



	cmxcmxcm
89250-10	24x24x 5
89250-20	24x24x 8
89250-30	24x24x10
89250-40	48x26x 5
89250-50	52x26x 8
89250-60	52x26x10

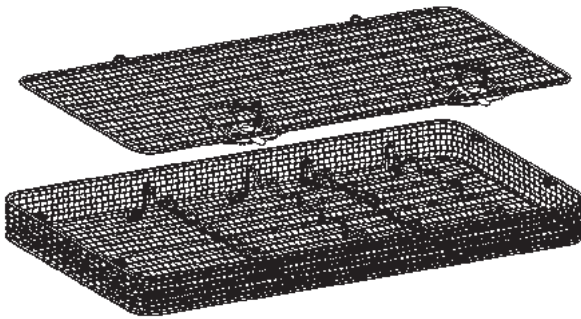

für Lichtleiterkabel  
 for cold light cables  
 para cables de luz fría  
 per cavi a fibre/ottiche  
 89255-60 420x250x60 mm

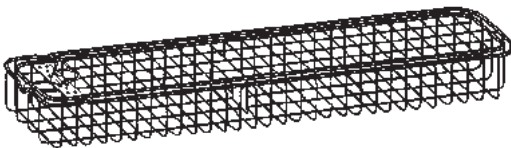

für 1 Endoskop, for 1 endoscope,  
 para 1 endoscopio, per 1 endoscopio  
 89256-29 290x80x52 mm  
 89256-46 460x80x52 mm  
 89256-67 670x80x52 mm

für 2 Endoskope, for 2 endoscopes,  
 para 2 endoscopios, per 2 endoscopi rigidi  
 89257-46 460x80x52 mm



**MAST.SH-GERMANY**

Schlauchklemmen, Messgerät, Sterilisierklammern  
Tubing Clamp, Decimal spring caliper, Safety pins  
Pinzas para tubos, calibrador decimal, Cadres de esterilizacion  
Morsetti serratubi, compasso, pinze per sterilizzazione

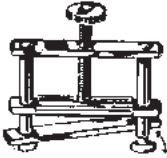

HOFFMANN

89260-13 13 mm  
89260-17 17 mm  
89260-20 20 mm  
89260-25 25 mm  
89260-30 30 mm  
89260-40 40 mm

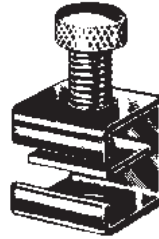

SIMPLEX

89265-12

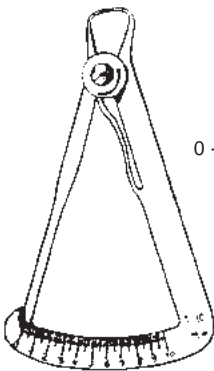

0 - 10 mm

IWANSON  
89270-15



BUNT  
29150-12  
12 cm, 4<sup>3</sup>/<sub>4</sub>"

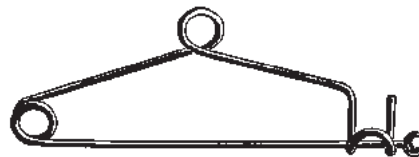

MAYO  
29152-14  
14 cm, 5<sup>1</sup>/<sub>2</sub>"



# MAST.SH-GERMANY

Hochfrequenz-Chirurgie  
High Frequency Surgery  
Electrocirugía  
Elettrochirurgia

Mindestbestellmenge 10  
Minimum order quantity 10  
Cantidad minima 10  
Minimo di quantitativo 10

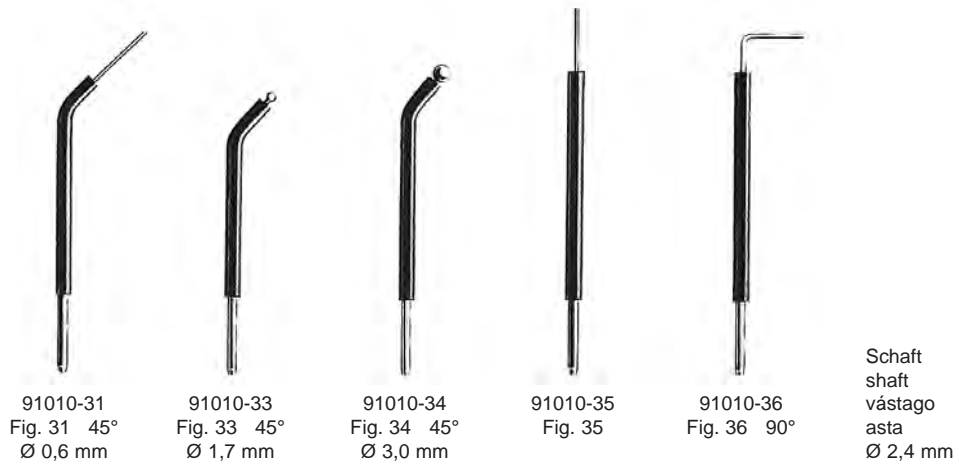
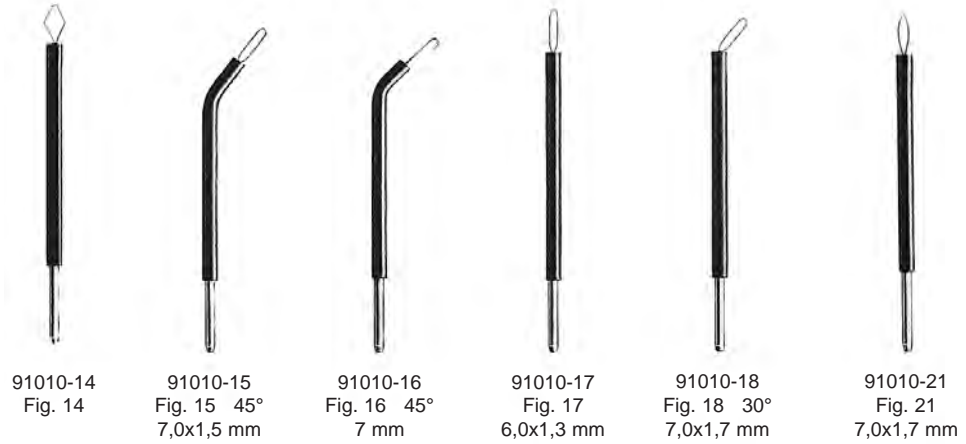





Mindestbestellmenge 10  
 Minimum order quantity 10  
 Cantidad minima 10  
 Minimo di quantitativo 10



91011-51  
 Fig. 51 45°  
 Ø 3 mm



91011-52  
 Fig. 52 45°  
 7,0x1,7 mm



91011-53  
 Fig. 53 45°



91011-54  
 Fig. 54



91011-55  
 Fig. 55



91011-56  
 Fig. 56 45°  
 Ø 5 mm



91011-61  
 Fig. 61 45°



91011-62  
 Fig. 62 90°

Schaft  
 shaft  
 vástago  
 asta  
 Ø 2,4 mm

**Serie STANDARD**



91020-01



91020-02

Schaft  
 shaft  
 vástago  
 asta  
 Ø 4 mm



91020-03



91020-04



Ø mm  
 5 91022-05  
 10 91022-10  
 20 91022-20



Ø mm  
 10 91024-10  
 15 91024-15  
 20 91024-20



Ø mm  
 2 91030-02  
 4 91030-04  
 6 91030-06

Schaft  
 shaft  
 vástago  
 asta  
 Ø 4 mm



# MAST.SH-GERMANY

Bipolare Koagulation  
Bipolar Coagulation  
Coagulación bipolar  
Coagulazione bipolare

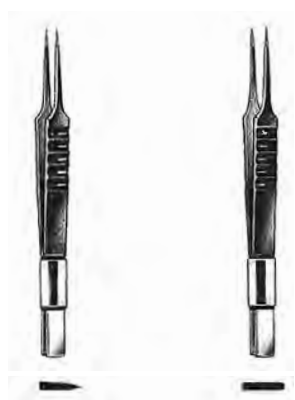

91102-11  
11 cm, 4 3/8"

91104-11  
11 cm, 4 3/8"

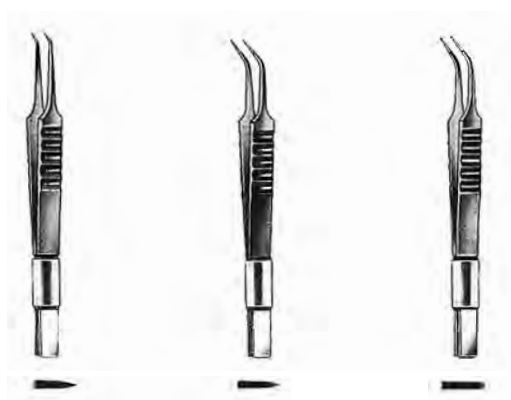

91109-11  
11 cm, 4 3/8"  
45°

91113-11  
11 cm, 4 3/8"  
45°

91115-11  
11 cm, 4 3/8"  
45°



91122-16  
16,5 cm, 6 1/2"

91123-16  
16,5 cm, 6 1/2"



91124-16  
16,5 cm, 6 1/2"  
1 mm



91125-16  
16,5 cm, 6 1/2"



91127-16  
16,5 cm, 6 1/2"  
1 mm

Bipolare Koagulation  
 Bipolar Coagulation  
 Coagulación bipolar  
 Coagulazione bipolare



91142-16  
 16,5 cm, 6 1/2"



91144-16  
 16,5 cm, 6 1/2"



91146-16  
 16,5 cm, 6 1/2"  
 1 mm



91152-19  
 19,5 cm, 7 3/4"



91154-19  
 19,5 cm, 7 3/4"  
 1 mm



91157-19  
 19,5 cm, 7 3/4"  
 1 mm



91159-19  
 19,5 cm, 7 3/4"  
 " 2 mm



# MAST.SH-GERMANY

Bipolare Koagulation  
Bipolar Coagulation  
Coagulación bipolar  
Coagulazione bipolare



91162-19  
19,5 cm, 7 3/4"



91164-19  
19,5 cm, 7 3/4"  
1 mm



91166-19  
19,5 cm, 7 3/4"  
2 mm



91167-19  
19,5 cm, 7 3/4"  
1 mm



91169-19  
19,5 cm, 7 3/4"  
1 mm



91172-03 - 91172-12  
22,5 cm, 8,9"



91172-03  
0,3 mm



91172-07  
0,7 mm



91172-12  
1,2 mm

Bipolare Koagulation  
 Bipolar Coagulation  
 Coagulación bipolar  
 Coagulazione bipolare

Verbindungskabel  
 Connection Cords  
 Cables de conexión  
 Cavi da connessione



	ERBE SELECT		AESCULAP	USA Mod.	MARTIN
3 m	118"	91190-30	91191-30	91192-30	91193-30
5 m	197"	91190-50		91192-50	91193-50

für Elektro-Chirurgie-Einheiten  
 for Electrosurgery Equipment  
 para Electrobisturías  
 per Elettrobisturi



Anlegezange, OLIVECRONA-TOENNIS .....	326	anatomische Pinzette, POTTS-SMITH.....	81	Arterienklemme, MAYO-GUYON.....	122
Abfallzange, SAUERBRUCH .....	227	anatomische Pinzette, SEMKEN.....	86	Arterienklemme, MEEKER.....	119
Abortuskürette, PESTALOZZA .....	606	anatomische Pinzette, TAYLOR.....	87	Arterienklemme, Micro-HARTMANN .....	104
Abortuslöffel, CUZZI.....	606	anatomische Pinzette, TC .....	81	Arterienklemme, MIXTER .....	119/1
Abortuslöffel, WALLICH.....	607	anatomische Pinzette, STILLE .....	81	Arterienklemme, MIXTER-BABY .....	119/1
Abortuszange, SAEGER .....	606	ANDERSON-ADSON, Wundspreizer .....	172	Arterienklemme, MOYNIHAN .....	120
Abortuszange, WINTER.....	606	ANDERSON, Wundhaken .....	198	Arterienklemme, O'SHAUGNESSY .....	119/2
ABRAHAM, Tonsillenfaßzange .....	468	ANDREW, Zungendrücker .....	452	Arterienklemme, OVERHOLT .....	114
ABRAHAM, Tonsillennmesser .....	466	ANDREW-PYNCHON, Saugrohr .....	28	Arterienklemme, PEAN .....	108, 110
Absaugküretten .....	600	Anesthophon .....	23	Arterienklemme, PENNINGTON .....	109
Absaugrohr, BUIE .....	566	Aneurysmaklemme, DeBAKEY-BAHNSON .....	506	Arterienklemme, PROVIDENCE-HOSPITAL .....	106
ADLERKREUTZ, Gefäßpinzette.....	84	Anlegepinzette, MEHDORN .....	362	Arterienklemme, ROBERTS .....	117
ADSON, anatomische Pinzette .....	81/2	Anlegezange .....	357 - 360	Arterienklemme, ROCHESTER-CARMALT .....	109
ADSON, Arterienklemme .....	112	Anlegezange, JOHNS-HOPKINS .....	104	Arterienklemme, ROCHESTER-OCHSNER .....	108
ADSON-BABY, Arterienklemme .....	113	Anlegezange, McKENZIE .....	326	Arterienklemme, ROCHESTER-PEAN .....	108
ADSON-BABY, Wundspreizer .....	173	Anlegezange, SMITHWICK.....	326	Arterienklemme, RUMEL .....	117
ADSON, chirurgische Pinzette .....	81/2	Anlegezange, SWEET .....	326	Arterienklemme, SAROT .....	118
ADSON, Durahaken.....	329	ANTRUM, Kürette.....	435	Arterienklemme, SPENCER-WELLS .....	109
ADSON, Halteklemme .....	298	Antrumkürette, COAKLEY .....	449	Arterienklemme, STILLE .....	122
ADSON, Hohlmeißelzange .....	236	Antrumraspel, WIENER .....	443	Arterienklemme, TOENNIS .....	117
ADSON, Hypophysepinzette .....	334	Antrumraspel, GALLAHER .....	446	Arterienklemme, WIKSTROEM .....	117
ADSON-Micro, anatomische Pinzette.....	81/2	Anuskop, HIRSCHMANN .....	562	Arterienklemme, ZENKER .....	118
ADSON-Micro, chirurgische Pinzette .....	82	Anuskop, IVES-FANSLER .....	562	Arterienklemme, OVERHOLT-BABY .....	114
ADSON, Nadelhalter.....	211	Anuskop, KELLY .....	562, 563	Arterienklemme, OVERHOLT-GEISSENDOERFER .....	114
ADSON, Raspator .....	282	ANVIL, Nagelspaltzange .....	613	Arterienklemme, OVERHOLT-MIXTER.....	115
ADSON, Saugrohr .....	337	Aorta-Aneurysmaklemme, DeBAKEY .....	496 - 498	ASCH, Septumrichtzange .....	449
ADSON, Wundspreizer .....	172 - 174	Aortadilatator, COOLEY .....	528	Atrauma-Arterienklemme, DeBAKEY-MOSQUITO .....	509
ADSON-BROWN, chirurgische Pinzette .....	82	Aortadilatator,TUBBS .....	528	Atrauma-Arterienklemme, DeBAKEY-PEAN.....	513
AEBLI, Ophthalmologie-Schere .....	58	Aortaklemme, DIETRICH .....	510	Atrauma-Arterienklemme, DeBAKEY-RANKIN .....	512
AESCULAP, Verbindungskabel .....	633	Aortaklemme, MORRIS-DeBAKEY .....	506	Atrauma-Bulldogklemme, DeBAKEY .....	103
Ahle, OBWEGESER .....	463, 463/3	Aortaklemme, DeBAKEY .....	499, 500	Atrauma-Bulldogklemme, GLOVER .....	103
AIR-INJECTION, Augenkannüle .....	394	Aortaklemme, WEBER.....	501	Atrauma-Darmfaßzange .....	539
ALAN-PARKS, Mastdarm-Spekula .....	561	Approximator, BIEMER .....	366	Atraumaklemmen.....	492 - 523, 526, 527
ALDERDYCE, Elevator .....	363	Approximator, BIEMER-MÜLLER .....	363	Atrauma-Neonatalklemme.....	523
ALEXANDER, Biopsiezange .....	589	Approximator, MÜLLER.....	364	Atrauma-Pinzette, DeBAKEY .....	98
ALEXANDER, Flachmeißel .....	259	ARCHER, Splitterzange .....	92	Atrauma-Pinzette, DeBAKEY TC .....	99
ALEXANDER, Hohlmeißel .....	259	ARLT, Starschlinge .....	378	Atrauma-Gefäßklemme, BECK .....	516
ALEXANDER, Raspator .....	276	Armsystem .....	188, 189	AUFRANC-COBRA, Knochenhebel .....	289
ALEXANDER, Uterus-Biopsiezange .....	589	ARRUGA, Extraktionshaken .....	375	AUFRANC-COBRA, Wundhaken .....	289
ALLEN, Blinddarmklemme .....	544	ARRUGA, Kapselpinzette .....	391	Aufreiber, KUENTSCHER .....	321
ALLIS, Darmfaßzange .....	537	ARRUGA, Lidsperrerr .....	370	AUFRIEHT, Nasenhaken .....	447
ALLIS-ADAIR, Darmfaßzange.....	537	ARRUGA, Nadelhalter .....	214	AUFRIEHT, Nasenraspel .....	443
ALLIS-BABY, Darmfaßzange .....	537	ARRUGA, Wundlöffel.....	378	Aufsatz allein f. Uterus-Biopsiezangen .....	591
ALLISON, Lungenspatel .....	489	Arterienklemme, BIRKETT .....	116	Aufsatz f. Reinigungspistole.....	626
ALM, Wundhaken .....	168	Arterienklemme, MIXTER .....	116	Aufsatz, BARACANI.....	472
ALU, Stimmgabeln .....	403	Arterienklemme, ADSON .....	112	Aufsatz, BRUENINGS .....	472
ALVIS, Fremdkörperkürette .....	374	Arterienklemme, ADSON-BABY .....	113	Aufsatz, CORDES.....	472
Amnioskop .....	601	Arterienklemme, BAINBRIDGE .....	119/2	Aufsatz, FRAENKEL .....	472
Amniotom, BEACHAM .....	586	Arterienklemme, BENGOLEA .....	112	Aufsatz, KRAUSE .....	472
Amputationsmesser, CATLIN.....	44	Arterienklemme, CRAFOORD .....	118	Aufsatz, LANGE .....	472
Amputationsmesser, LANGENBECK .....	44	Arterienklemme, CRAFOORD-SELLORS .....	119	Aufsatz, SCHEINMANN.....	472
Amputationsmesser, LISTON .....	44	Arterienklemme, CRILE .....	107	Aufsatz, SCHUMACHER .....	472
Amputationsmesser, REDA .....	44	Arterienklemme, CRILE-RANKIN .....	107	Aufsatz, SEIFERT .....	472
Amputationssäge, BIER .....	296	Arterienklemme, DANDY .....	109	Aufsätze f. SLUDER-BALLENGER .....	470
Amputationssäge, CHARRIERE .....	296	Arterienklemme, DESJARDINS .....	121	Augenkannüle, AIR-INJECTION .....	394
Amputationssäge, SATTERLEE .....	296	Arterienklemme, FUCHSIG.....	113	Augenkannüle, JENSEN .....	394
Analspreizer, SMITH-BUIE.....	561	Arterienklemme, GEMINI .....	115	Augenkannüle, LACRIMAL .....	394
Anastomosenklemme, BECK.....	516, 520	Arterienklemme, GRAY .....	121	Augenkannüle, McINTYRE .....	394
Anastomosenklemme, COOLEY-DERRA .....	519	Arterienklemme, GUYON .....	122	Augenkannüle, SHEETS.....	394/2
Anastomosenklemme, DE MARTEL-WOLFSON .....	546	Arterienklemme, HALSTED-MOSQUITO .....	105	Augenkannülen .....	394
Anastomosenklemme, DeBAKEY .....	505	Arterienklemme, HARTMANN .....	104	Augenmagnet, REDA .....	395
Anastomosenklemme, LAMBERT-KAY .....	505	Arterienklemme, HEISS.....	112	Augenschere, BARRAQUER .....	75
Anastomosenklemme, DERRA .....	515	Arterienklemme, JACOBSON .....	105	Augenschere, NOYES .....	75
Anastomosenklemme, POTTS .....	493	Arterienklemme, JOHNS-HOPKINS .....	120	Augenschere, VANNAS .....	79
anatomische Pinzette, BROPHY .....	84	Arterienklemme, KANTROWITZ .....	119/1	Augenschere, WECKER .....	75
anatomische Pinzette .....	81	Arterienklemme, KELLY .....	106	Augenschere, WESTCOTT .....	75
anatomische Pinzette, ADSON .....	81/2	Arterienklemme, KELLY-RANKIN .....	106	Aurikelklemme, HARKEN .....	503
anatomische Pinzette, ADSON-Micro.....	81/2	Arterienklemme, KOCHER .....	108	Autopsiesäge.....	231/1
anatomische Pinzette, BONNEY .....	88	Arterienklemme, LAHEY .....	119/2	AUVARD, Scheidenspekula .....	576
anatomische Pinzette, CUSHING .....	83	Arterienklemme, LAWRENCE .....	119	AXENFELD, Chlazonionskürette .....	377
anatomische Pinzette, GERALD .....	86, 87	Arterienklemme, LERICHE .....	111	AYER, Chlazonionspinzette .....	393
anatomische Pinzette, McINDOE .....	85	Arterienklemme, LOVEFACE .....	109		
anatomische Pinzette, USA .....	81	Arterienklemme, LOWER .....	120		



<b>B</b>	Bauchdeckenhalter, DE BAKEY .....	189/1	Biopsiezange, THOMAS-GAYLOR .....	588	
BABCOCK, Darmfaßzange .....	539	Bauchdeckenhalter, DOYEN .....	189/1	Biopsiezange, TISCHLER-DOWN .....	591
BABINSKI, Perkussionshammer .....	24	Bauchdeckenhalter, GELPI .....	189/1, 189/2	Biopsiezange, TISCHLER-MORGAN .....	591
BABY-BURKE, Uterus-Biopsiezange .....	590	Bauchdeckenhalter, RIGBY .....	189/2	Biopsiezange, TISCHLER-UP .....	591
BABY-GOSSET, Bauchdeckenhalter .....	181	Bauchdeckenhalter, JACKSON-BURROWS .....	189/2	Biopsiezange, TOWNSEND .....	591
BABY-KOCHER, Darmklemme .....	540	Bauchspatel .....	143	Biopsiezange, VAN DOREN .....	588
BABY-METZENBAUM, Supercutschere .....	71	Bauchspatel, KADER .....	143/1	Biopsiezange, WITNER .....	589
BABY-OLSEN-HEGAR, Nadelhalter .....	212	Bauchspatel, KÖRTE .....	143/1	Bipolare Koagulation .....	630 - 633
BABY-WEBSTER, Nadelhalter .....	208	Bauchspatel, KÜMMEL .....	143/2, 144	Bipolarkabel .....	633
BABY-YANKAUER, Saugrohr .....	27	Bauchspatel, LERICHE .....	143/2	Bipolarpinzette .....	630 - 632
BABYPHON, Blutdruckmeßgerät .....	10	BAUMGARTNER, Nadelhalter .....	208	BIRCHER-GANSKE, Knochenhaltezange .....	246
BABY-TISCHLER, Uterus-Biopsiezange .....	592	BEACHAM, Amniotom .....	586	BIRKETT, Arterienklemme .....	116
BACKHAUS, Tuchklemme .....	132	BECHERT, Linsenmanipulator .....	379	BISHOP-HARMAN, Irispinzette .....	386
BACKHAUS-CLIP, Tuchklemme .....	132	BECK, Anastomosenklemme .....	516, 520	BISHOP-HARMON, Spül- und Saugkanüle .....	394/1
BAILEY-BABY, Rippenkontraktor .....	489	Beckenzirkel, COLLIER .....	605	BLAKE, Gallensteinzange .....	531
BAILEY-GIBBON, Rippenkontraktor .....	489	Beckenzirkel, COLLIN .....	605	BLAKE, Uteruskürette .....	595
BAILEY, Rippenkontraktor .....	489	Beckenzirkel, MARTIN .....	605	Blasenhalssperrer, MILLIN .....	553
BAINBRIDGE, Arterienklemme .....	119/2	BECKER, Cystotom .....	375	Blasenspatel, KOCHER .....	552
BAINBRIDGE, Mehrzweck-Gefäßklemme .....	495	BECKMANN, Ringmesser .....	450	Blasenspatel, LEGUEU .....	552
BAKES, Gallengangdilator .....	532	BECKMANN, Wundspreizer .....	176	Blasenwundspreizer, LEGUEU .....	553
BALFOUR-BABY, Bauchdeckenhalter .....	182	BECKMANN-ADSON, Wundspreizer .....	175	Blasenwundspreizer, MILLIN .....	552
BALFOUR, Bauchdeckenhalter .....	182	BECKMANN-EATON, Wundspreizer .....	176	Blasenwundspreizer, THOMSON-WALKER .....	552
BALFOUR, Haken .....	193	BEEBEE, Kronenschere .....	68	Blasenwundspreizer, JUDD-MASSON .....	552
BALFOUR, Valve f. Bauchdeckenhalter .....	183	BEER, Cilienpinzette .....	395	Blattostotom, OBWEGESER .....	464/1
BALFOUR-US, Bauchdeckenhalter .....	184	BEESON, Gips spreizer .....	232	Bleihand .....	250
BALL AND SOCKET, Tuchklemme .....	133	Beinhautmesser .....	47	Blinddarmklemme, ALLEN .....	544
BALLENGER, Schwingmesser .....	436	Beleuchtungsstab f. MORGAN .....	565	Blinddarmklemme, KLEINSCHMIDT .....	544
BALLENGER, Septumelektor .....	439	BELLUCCI, Mikro-Ohrscherchen .....	413, 417	BLOHME, Tonsillenzange .....	467
BALLENGER, Tonsillenzange .....	467	BENDER, Einschläger .....	322	BLOUNT, Knochenhebel .....	288
Bandmaß .....	25	BENGOLEA, Arterienklemme .....	112	BLOUNT, Meniskusshaken .....	289
Bandscheibenstanze, FERRIS-SMITH-KERRISON .....	344, 344/2	BENNETT, Knochenhebel .....	283	BLUMENTHAL, Hohlmeißelzange .....	236
Bandscheibenstanze, COLCLOUGH .....	344/1	BENSAUDE, Proktoskop .....	565	Blutdruckmessgerät, BABYPHON .....	10
BANE-HARTMANN, Hohlmeißelzange .....	237	BENSON, Pylorus spreizer .....	544	Blutdruckmessgerät, DIPLOMAT .....	5
BANGERTER, Zykliodialysespatel .....	379	BERENS, Diszisionsmesser .....	372	Blutdruckmessgerät, EXACTA .....	8
BARACANI, Aufsatz .....	472	BERGMANN, Hammer .....	272	Blutdruckmessgerät, PRECISA .....	9
BARANY, Lämtrömmel .....	405	BERGMANN, Verbandschere .....	69/1	Blutschöpföffel .....	268
BARBARA, Häkchen .....	419	BERKE, Beckelpinzette .....	389	Blutstillungsmeißel, PASSOW .....	260
BARBARA, Nadel .....	419	BERLINER, Perkussionshammer .....	24	BODENHAMMER, Mastdarmspekula .....	559
BARKAN, Goniotomiemesser .....	373	BERNHARD, Tuchklemme .....	133	BOEHLER, Extensionsbügel .....	312
BARNHILL, Ringmesser .....	450	BERRY, Drahtzange .....	319	BOERMA, Geburtszange .....	604
BARON, Saugrohr .....	336	Beschaidungsgerät, MOGEN .....	556	BOETTCHE, Tonsillenschere .....	59
BARR, Mastdarmspekula .....	559	BETHUNE, Rippenschere .....	481	BÖHLER, Hohlmeißelzange .....	238
BARRAQUER, Augenschere .....	75	Biegehebel, LANE .....	325	BÖHLER, Knochen splitterzange .....	241
BARRAQUER, Cilienpinzette .....	395	BIEMER, Approximator .....	366	Bohrapparat, STILLE-SHERMAN .....	298
BARRAQUER, Fixationspinzette .....	390	BIEMER, Gefäßclip .....	361	Bohrdraht, KIRSCHNER .....	306, 307
BARRAQUER, Irispinzette .....	384	BIEMER-MÜLLER, Approximator .....	363	Bohrdrahtspender .....	305, 310
BARRAQUER, Keratoplastik-Messer .....	373	BIER, Amputationssäge .....	296	Bohrdrahtstütze .....	299
BARRAQUER, Lidsperrer .....	370	BILL, Zughebel .....	604	Bohrer .....	298, 302
BARRAQUER, Nadelhalter .....	216, 217	BILLEAU, Ohrschlinge .....	409	Bohrer, CRUTCHFIELD .....	327
BARRAQUER-KATZIN, Irispinzette .....	384	Biopsie- und Absaugkürette .....	600	Bohrer, ERRICO .....	299
BARRAQUER-TROUTMAN, Nadelhalter .....	216	Biopsiekannüle, MENGHINI .....	206	Bohrer, Mc KENZIE .....	299
BARRET, Hakenzange .....	582	Biopsiekürette, HEANY .....	587	BOIES, Elevator .....	277
BARTON, Geburtszange .....	603	Biopsiekürette, KEVORKIAN .....	587	Bolzenschneider .....	320
BARTON, Zughebel .....	603	Biopsiekürette, MOD. MÜNCHEN .....	587	BONACCOLTO, Strabismus pinzette .....	385
Batteriegriff f. Kaltlicht .....	33	Biopsiekürette, NOVAK .....	587	BONN, Irispinzette .....	387
Batteriegriff f. Warmlicht .....	32	Biopsiekürette, RANDALL .....	587	BONNEY, anatomische Pinzette .....	88
Bauch- u. Darmspatel, KÜMMEL .....	143/2	Biopsieküretten .....	600	BONNEY, chirurgische Pinzette .....	88
Bauchdeckenhalter, BABY-GOSSET .....	181	Biopsienadel, FRANKLIN-SILVERMANN .....	206	BOSE, Trachealhaken .....	477
Bauchdeckenhalter, BALFOUR .....	182	Biopsiezange, KEVORKIAN-PACIFIC .....	592	BOSE, Trachealspreizer .....	476
Bauchdeckenhalter, BALFOUR-BABY .....	182	Biopsiezange, TISCHLER-KEVORKIAN .....	592	BOUCHERON, Ohrspekula .....	399
Bauchdeckenhalter, BALFOUR-US .....	184	Biopsiezange, TISCHLER-MORGAN .....	590	BOWMAN, Diszionsmesser .....	372
Bauchdeckenhalter, CHARNELY .....	289	Biopsiezange, ALEXANDER .....	589	BOWMAN, Diszisionsnadel .....	374
Bauchdeckenhalter, COLLIN .....	190	Biopsiezange, BABY-TISCHLER .....	592	BOWMAN, Lidsperrer .....	370
Bauchdeckenhalter, COLLIN-LOKITE .....	191	Biopsiezange, BURKE .....	590	BOWMAN, Tränenkanalsonde .....	381
Bauchdeckenhalter, DENIS-BROWNE .....	185	Biopsiezange, BURKE-BABY .....	590	Box, PETRI .....	620
Bauchdeckenhalter, FRAZIER .....	181	Biopsiezange, EPPENDORFER .....	590	BOYNTON, Nadelhalter .....	214
Bauchdeckenhalter, GOSSET .....	181	Biopsiezange, FAURE .....	588	BOYS-ALLIS, Darmfaßzange .....	538
Bauchdeckenhalter, KIRSCHNER .....	185, 187, 187/1	Biopsiezange, KEVORKIAN .....	589, 591	BOZEMANN, Nadelhalter .....	211
Bauchdeckenhalter, O'SULLIVAN-O'CONNOR .....	181	Biopsiezange, MAXI GRASPER .....	593	BOZEMANN, Tamponzange .....	138
Bauchdeckenhalter, RICARD .....	181	Biopsiezange, MINI-TOWNSEND-DOWN .....	591	BOZEMANN-DOUGLAS, Tamponzange .....	138
Bauchdeckenhalter, ROCHARD .....	186	Biopsiezange, MINI-TOWNSEND-UP .....	591	BRAND, Sehnenfaßinstrument .....	293
Bauchdeckenhalter, COLLIN .....	190	Biopsiezange, SCHUBERT .....	588	BRAND, Sehenschäler .....	294
		Biopsiezange, SCHUMACHER .....	588, 589	BRAUN, Dekapitationsshaken .....	607





BRAUN, Hakenzange.....	582	CASPAR, Stössel.....	258	Circumcionsgerät.....	556
BRAUN, Kranioklast.....	607	CASPAR, Wundspreizer.....	179	CITELLI, Knochenstanze.....	430
BRAUN, Uterusdepressor.....	586	CASTANEDA, Neonatal-Gefäßklemme.....	527	CLAR, Stirnlampe.....	22
BRAUN-STADLER, Episotomie-Schere.....	64	CASTROVIEJO, Disziionsmesser.....	372	CLARK, Lidsperrer.....	370
BREAST, Wundhaken.....	198	CASTROVIEJO, Fixierpinzette.....	390	CLAUS, Tonsillennadel.....	466
BREISKY, Scheidenspekula.....	577	CASTROVIEJO, Hornhautschere.....	79	CLAUS-EICKEN, Tonsillennadel.....	466
Breiten-Messinstrument.....	594	CASTROVIEJO, Kapselpinzette.....	391	CLAYMAN, Hähchen.....	376
BRISTOW, Knochenhebel.....	290	CASTROVIEJO, Klingenbrecher.....	45	CLEVELAND, Hohlmeißelzange.....	235
BRODIE, Hohlsonde.....	199	CASTROVIEJO, Lidsperrer.....	371	Clipanlegezange, ETHICON.....	524, 525
Bronchoskopiezange, CHEVALIER-JACKSON.....	473	CASTROVIEJO, Meßzirkel.....	380	Clipanlegezange, HORIZON.....	524, 525
Bronchusklemme.....	126	CASTROVIEJO, Nadelhalter.....	215, 216	Clipanlegezange, PILLING.....	524, 525
Bronchusklemme, FINOCCHIETTO.....	490	CASTROVIEJO, Nahtpinzette.....	392	Clipanlegezange, SLS Clips.....	524, 525
Bronchusklemme, HARRINGTON.....	490	CASTROVIEJO, Tränenkanaldilatator.....	381	CLOWARD, Laminektomiezange.....	342
Bronchusklemme, LEES.....	504	CASTROVIEJO, Zyklolysespatel.....	379	CLOWARD, Wirbelkörperspreizer.....	339
Bronchusklemme, PRICE-THOMAS.....	490	CASTROVIEJO-Micro, Nadelhalter.....	215	CLOWARD, Wundsperrerr.....	178
Bronchusklemme, SEMB.....	491	CASTROVIEJO-STANDARD, Nadelhalter.....	216	COAKLEY, Antrumkürette.....	449
BROPHY, anatomische Pinzette.....	84	CATLIN, Amputationsmesser.....	44	COAKLEY, Kieferhöhentroker.....	204
BROPHY, chirurgische Pinzette.....	84	Cauter, WADSWORTH-TODD.....	378	Coarctationsklemme, DeBAKEY.....	507
BROWN, Gewebepinzette.....	83	CAWOOD-MINNESOTA, Wangenhalter.....	451	Coarctationsklemme, POTTS.....	492
BROWN, Nadelhalter.....	209	Chalazionskürette, AXENFELD.....	377	COBB, Hohlmeißel.....	262
BRUENINGS, Aufsatz.....	472	Chalazionskürette, HEBRA.....	377	COBB, Kürette.....	252
BRUENINGS, Ohrspekula.....	401	Chalazionskürette, MEYHOEFER.....	377	COBB, Raspator.....	280
BRUENINGS, Septumzange.....	425	Chalazionspinzette, AYER.....	393	COBB, scharfer Löffel.....	252
BRUENINGS, Tonsillennmesser.....	466	Chalazionspinzette, DESMARRES.....	393	COLCLOUGH, Bandscheibenstanze.....	344/1
BRUENINGS, Tonsillenschürer.....	468	Chalazionspinzette, LAMBERT.....	393	COLLER-CRILE, Arterienklemme.....	106
BRUENINGS, Verlängerungsrohr.....	472	CHANDLER, Elevator.....	282	COLLIER, Beckenzirkel.....	605
BRUENINGS, Zungenspatel.....	451	CHAPUT, Gewebefaßzange.....	110	COLLIER, Nadelhalter.....	208
BRUNETTI, Meißel.....	268	CHARNLEY, Bauchdeckenhalter.....	289	COLLIN, Bauchdeckenhalter.....	190
BRÜNINGS-LUCAS, Flachmeißel.....	260	CHARRIERE, Amputationssäge.....	296	COLLIN, Beckenzirkel.....	605
BRUNNER, Darmklemme.....	543	HEATLE, Sterilisierzange.....	227	COLLIN, Darmfaßzange.....	539
BRUNNER, Führungshohlsonde.....	221	CHELSEA-EATON, Proktoskop.....	563	COLLIN, Dynamometer.....	25
BRUNNER, Rippenschere.....	481	CHERON, Tupferzange.....	137	COLLIN, Gewebefaßzange.....	110
BRUNNER, Wundhaken.....	167	CHERRY, Laminektomiesperrer.....	488	COLLIN, Hammer.....	270
BRUNS, scharfer Löffel.....	251	CHEVALIER-JACKSON, Bronchoskopiezange.....	473	COLLIN-LOKTITE, Bauchdeckenhalter.....	191
BRUNS, Verbandschere.....	70	CHEVALIER-JACKSON, Trachealkanüle.....	479	COLLIN, Nabelschnurklemme.....	605
Bruststütze, KLEINSASSER.....	36	CHILDE, Wundklammerzange.....	224	COLLIN, Scheidenspekula.....	570
Bruststütze, NEGUS.....	459	chirurgische Nadel, KEITH.....	223	COLLIN, Sonde.....	586
BRYANT, Tupferzange.....	137	chirurgische Nadel, KOENIG.....	223	COLLIN, Tupferzange.....	137
BUCHWALD, Zungenspatel.....	451	chirurgische Nadeln.....	222	COLLIN, Uterus-Faßzange.....	585
BUCK, Fremdkörperhebel.....	412	chirurgische Pinzette.....	81/1	COLLIN, Uterus-Sonde.....	586
BUCK, Ohrkürette.....	407	chirurgische Pinzette, GERALD.....	87	COLLIN, Wundhaken.....	139
BUCK, Perkussionshammer.....	24	chirurgische Pinzette, POTTS-SMITH.....	81	COLLIN, Wundklammerzange.....	224
BUCK-GRAMCKO, Knochenhebel.....	285	chirurgische Pinzette, WAUGH.....	83	COLLIN, Zungenzange.....	453
BUJIE, Rektal-Absaugrohr.....	566	chirurgische Pinzette, ADSON.....	81/2, 82	COLLIN-DUVAL, Faßpinzette.....	85
Bulldogklemme, ATRAUMA.....	100	chirurgische Pinzette, ADSON-Micro.....	82	COLLIN-HARTMANN, Wundhaken.....	141
Bulldogklemme, DeBAKEY.....	103	chirurgische Pinzette, ADSON-BROWN.....	82	Columella-Pinzette, COTTLE.....	448
Bulldogklemme, GLOVER.....	103	chirurgische Pinzette, BONNEY.....	88	COLVER, Tonsillenfaßzange.....	467
Bulldogklemme, JOHNS-HOPKINS.....	104	chirurgische Pinzette, BROPHY.....	84	CONE, Schädelstanze.....	331
BÜLOW-GUNAR-HEY, Schlauchklemme.....	130	chirurgische Pinzette, CUSHING.....	83	CONNIN-AMSLER, Markierungsinstrument.....	380
BUMM, Uteruskürette.....	597, 598	chirurgische Pinzette, FERRIS-SMITH.....	85	CONVERSE, Nasenhaken.....	448
BUNELL, Handbohrapparat.....	299	chirurgische Pinzette, GILLIES.....	86	CONVERSE, Nasenmesser.....	435
BUNELL, Sehnenführer.....	294	chirurgische Pinzette, LANE.....	84	COOLEY, Aortadilatator.....	528
BUNELL, Sehenschäler.....	292	chirurgische Pinzette, USA.....	81/1	COOLEY, Katheterklemme.....	510
BUNGE, Exenterationslöffel.....	378	chirurgische Pinzette TC, OEHLER.....	81/1	COOLEY, Kinder-Gefäßklemmen.....	522
BUNT, Sterilisierklammer.....	227, 624	chirurgische Pinzette, SEMKEN.....	86	COOLEY, Mehrzweck-Gefäßklemme.....	520
BURCH, Fixiergabel.....	373	chirurgische Pinzette, STILLE.....	81/1	COOLEY, Rippensperrer.....	485, 487
BURKE, Uterus-Biopsiezange.....	590	chirurgische Pinzette, TAYLOR.....	87	COOLEY, Wundhaken.....	148
Bürstenspendler.....	611	chirurgische Schere, IRIS.....	54	COOLEY-DERRA, Anastomosenklemme.....	519
BUSCH, Schere.....	64	chirurgische Schere, JOSEPH.....	54	COOLEY-NEONATAL, Rippensperrer.....	485
BUSHE, scharfer Löffel.....	256	chirurgische Schere, KILNER.....	54	COOLY, Saugrohr.....	28
C.....		chirurgische Schere, REYNOLDS.....	54	COOPER, Unterbindungsnadel.....	219
CANFIELD, Tonsillennesser.....	466	chirurgische Schere, SANVENERO.....	54	CORDES, Aufsatz.....	472
CAPLAN, Nasenzange.....	428	chirurgische Schere, STANDARD.....	51	CORONAL-BROW, Wundhaken.....	198
Cardiovascular-Klemme.....	526	chirurgische Schere, FERGUSSON.....	66	CORWIN-HEGAR, Drahtzange.....	319
CARMALT, Splitterpinzette.....	91	chirurgische Schere, METZENBAUM S.....	54	CORYLLOS, Rippenschere.....	480
CAROLL, Sehnenfaßinstrument.....	293	chirurgische Schere, SYSTRUNK.....	66	CORYLLOS, Wundhaken.....	166
Carotis-Shuntklemme, JAVID.....	511	Cilienpinzette, BARRAQUER.....	395	COS, Mikro-Ohrzängchen.....	414
CARPENTER, Tonsillenelevator.....	465	Cilienpinzette, BEER.....	395	COTTLE, Columella-Pinzette.....	448
CARPENTER, Tonsillennesser.....	465	Cilienpinzette, DOUGLAS.....	395	COTTLE, Bulldogschere.....	56
Cartilageschere, MARTIN.....	65/1	Cilienpinzette, GRADLE.....	395	COTTLE, Fixierpinzette.....	410
CASPAR, Laminektomiespreizer.....	179, 180	Cilienpinzette, LITTAUER.....	395	COTTLE, Hammer.....	273
CASPAR, Spreizer.....	197	Cilienpinzette, REDA.....	395	COTTLE, Hauthäkchen.....	447/1, 448
		CINELLI, Septummeißel.....	441	COTTLE, Knorpelquetscher.....	440





COTTLE, Nasenhaken.....	447, 447/1	Darmquetschklemme, PAYR-BABY.....	548	DESJARDINS, Gallensteinlöffel.....	534
COTTLE, Nasenmesser.....	435	Darmschere.....	66	DESJARDINS, Gallensteinsonde.....	532
COTTLE, Nasenschere.....	59	Darmspatel.....	143	DESJARDINS, Gallensteinzange.....	531
COTTLE, Nasenspekula.....	423	Darmspatel, HABERER.....	143/1	DESMARRES, Chalazionspinzette.....	393
COTTLE, Osteotom.....	440	Darmspatel, KADER.....	143/1	DESMARRES, Wundhaken.....	151
COTTLE, Schere.....	56	Darmspatel, KÖRTE.....	143/1	DEUTSCHMANN, Starmesser.....	371
COTTLE, Septum elevator.....	439	Darmspatel, KÜMMEL.....	143/2	DeVILBISS, Schädelzange.....	332
COTTLE, Septummeißel.....	440	Darmspatel, LERICHE.....	143/2	Diagnostik-Besteck ECO "C".....	16
COTTLE-JOSEPH, Septum elevator.....	439	Darmspatel, REVERDIN.....	143/1	Diagnostik-Besteck ECO "T".....	16
COTTLE-KAZANJIAN, Knochensplitterzange.....	241	Darmspatel, RIBBON.....	143	Diagnostik-Besteck, RI-MINI.....	17
COTTLE-NEIVERT, Hauthäkchen.....	448	DARTIGUES, Uterusfaßzange.....	585	Diagnostik-Besteck, UNI III.....	15
COXETER, Metallkatheter.....	555	DASTOOR, Strabismuspinzette.....	386	DIEFFENBACH, Gefäßklemme.....	104
CRAFOOD-SELLORS, Arterienklemme.....	119	DAUBENSPECK, scharfer Löffel.....	255	DIETER, Mikro-Ohrzängchen.....	414
CRAFOOD, Arterienklemme.....	118	DAVIDSON (SCAPULA), Wundhaken.....	166	DIETRICH, Aortaklemme.....	510
CRAFOOD, Lungenschere.....	65/2	DAVIEL, Starlöffel.....	377	DIETRICH, Gefäßschere.....	60
CREGO, Elevator.....	282	DAVIS, Duradissektor.....	332	DIETRICH, Mini-Bulldogklemme.....	101
CRILE, Arterienklemme.....	107	DAVIS, Fremdkörpernadel.....	374	Dilatationsbougie, DITTEL.....	554
CRILE, Nadelhalter.....	213	DAVIS, Sterilisierpinzette.....	227	Dilatationsbougie, GUYON.....	554
CRILE, Nervhaken.....	328	DAVIS-BOYLE, Mundsperrer.....	455	Dilatationsbougie, VAN BUREN.....	554
CRILE, Wundhaken.....	140	DAVIS-BOYLE, Sperrer.....	455	Dilatator, HANK.....	580
CRILE-MURRAY, Nadelhalter.....	209	DAVIS-BOYLE, Zugendrücken.....	455	Dilatator, HEGAR.....	578, 579
CRILE-RANKIN, Arterienklemme.....	107	DAVIS-MEYER, Mundsperrer.....	457	Dilatator, PRATT.....	580
CRILE-WOOD, Nadelhalter.....	209	DAY, Häkchen.....	409	DINGMANN, Elevator.....	463/3
CRITCHETT, Lidsperrer.....	370	DeBAKEY, Aorta-Aneurysmaklemme.....	496-498	DINGMANN, Knochenhalte zange.....	246
CRUTCHFIELD, Bohrer.....	327	DeBAKEY, Aortaklemme.....	499, 500	DINGMANN, Mundsperrer.....	456
CRUTCHFIELD, Schädelhalter.....	327	DeBAKEY, Bauchdeckenhalter.....	189/1	DINGMANN, Raspator.....	463, 463/3
CULLER, Irisspatel.....	378	DeBAKEY, Gefäßdilator.....	529	DINGMANN, Sperrer.....	456
CUSCO, Scheidenspekula.....	570, 571	DeBAKEY, Gefäßklemme.....	494-496	DIPLOMAT, Blutdruckmeßgerät.....	5
Cushing (TAYLOR), Pinzette TC.....	87	DeBAKEY, Ligaturklemme.....	499, 500	Dissektor, FISCH.....	420
CUSHING, anatomische Pinzette.....	83	DeBAKEY, Mehrzweck-Gefäßklemme.....	495, 508, 514-517	Dissektor, GORNEY.....	277
CUSHING, chirurgische Pinzette.....	83	DeBAKEY, Nadelhalter.....	210	Dissektor, PENFIELD.....	333
CUSHING, Bohrer.....	299	DeBAKEY, Saugrohr.....	28	Disziionsmesser, BOWMAN.....	372
CUSHING, Hirnspatel.....	336, 369	DeBAKEY, Tangentialklemme.....	502	Disziionsmesser, BERENS.....	372
CUSHING, Laminektomie zange.....	340	DeBAKEY-SATINSKY, Tangentialklemme.....	502	Disziionsmesser, CASTROVIEJO.....	372
CUSHING, Nervenhaken.....	328	DE BOER, Rippensperrer.....	486	Disziionsmesser, GRAEFFE.....	372
CUSHING, Pinzette.....	87	DE LEE, Geburtszange.....	602	Disziionsmesser, WHEELER.....	373
CUSHING, Wundhaken.....	151, 152	DE MARTEL, Führungsinstrument.....	330	Disziionsmesser, ZIEGLER.....	373
CUZZI, Abortuslöffel.....	606	DE MARTEL-WOLFSON, Anastomosenklemme.....	546	Disziionsnadel.....	374
Cystotom, BECKER.....	375	DE MARTEL-WOLFSON, Darmklemme.....	546	Disziionsnadel, BOWMAN.....	374
Cystotom, GRAEFFE.....	375	DE MARTEL-WOLFSON, Klemmenhalterung.....	546	DITTEL, Dilatationsbougie.....	554
CZERNY, Hakenzange.....	584	DE MARTEL-WOLFSON, Klemmenschießzange.....	546	DIX, Fremdkörperflachmeißel.....	374
CZERNY, Mastdarm-Spekula.....	559	DEAN, Irismesser.....	372	DIX, Fremdkörperinstrument.....	380
D		DEAN, Tonsillenschere.....	59	Doppelkürette.....	612
DANDY, Arterienklemme.....	109	DEAVER, Präparierschere.....	52	Doppellöffel, VOLKMANN.....	257
DANDY, Nervenhaken.....	328	DEAVER, Wundhaken.....	145, 146	DOUGHTY, Zungenspatel.....	458
DARLING, Wundspreizer.....	178	DEAVER-GRIP, Wundhaken.....	146	DOUGLAS, Cilienpinzette.....	395
Darmfaßzange, DOYEN-BABY.....	540	DeBAKEY, Anastomosenklemme.....	505	DOUGLAS, Kieferhöhlentrok ar.....	204
Darmfaßzange, LOCKWOOD-ALLIS.....	538	DeBAKEY, Atrauma-Bulldogklemme.....	103	DOUGLAS, Tonsillensmesser.....	466
Darmfaßzange, ALLIS.....	537	DeBAKEY, Atrauma-Pinzette.....	98	DOYEN, Bauchdeckenhalter.....	189/1
Darmfaßzange, ALLIS-ADAIR.....	537	DeBAKEY, Atrauma-Pinzette TC.....	99	DOYEN, Darmklemme.....	540
Darmfaßzange, ALLIS-BABY.....	537	DeBAKEY Atrauma-Pinzette TITAN.....	99	DOYEN, gynäkologische Schere.....	63
Darmfaßzange, ATRAUMA.....	539	DeBAKEY, Coarctationsklemme.....	507	DOYEN, Hohlsonde.....	199
Darmfaßzange, BABCOCK.....	539	DeBAKEY-BAHNSON, Aneurysmaklemme.....	506	DOYEN, Myomheber.....	594
Darmfaßzange, BOYS-ALLIS.....	538	DeBAKEY-DIETHRICH, Mini-Bulldogklemme.....	101	DOYEN, Raspator.....	278
Darmfaßzange, COLLIN.....	539	DeBAKEY-MOSQUITO, Atrauma-Arterienklemme.....	509	DOYEN, Scheidenspekula.....	574
Darmfaßzange, DUVAL.....	539	DeBAKEY-PEAN, Atrauma-Arterienklemme.....	513	DOYEN, Schere.....	63
Darmfaßzange, JUDD-ALLIS.....	538	DeBAKEY-RANKIN, Atrauma-Arterienklemme.....	512	DOYEN, Tuchklemme.....	133
Darmfaßzange, LITTLEWOOD.....	538	DEJERINE, Perkussionshammer.....	24	DOYEN, Uterus-Polypenzange.....	585
Darmfaßzange, THOMS-ALLIS.....	538	Dekapitationsshaken, BRAUN.....	607	DOYEN, Wundhaken.....	163
Darmfaßzange, WILLIAMS.....	539	DELEE, Scheidenspekula.....	574	DOYEN-BABY, Darmklemme.....	540
Darmklemme, BABY-KOCHER.....	540	DEMEI, Drahtspanninstrument.....	315	DOYEN-JANSEN (MOLT), Mundsperrer.....	454
Darmklemme, BRUNNER.....	543	DEMEI, Drahtumführungsnadel.....	315	DOYEN-STILLE, Wundhaken.....	167
Darmklemme, DE MARTEL-WOLFSON.....	546	DENHART, Mundsperrer.....	454	Drahtfaßzange.....	316, 318
Darmklemme, DOYEN.....	540	DENIS-BROWNE, Bauchdeckenhalter.....	185	Drahtgeflecht.....	311
Darmklemme, FEHLAND.....	542	DERF, Nadelhalter.....	208	Drahtkniefzange.....	317, 318, 320
Darmklemme, HAYES.....	545	Dermatom, HUMBY.....	50	Drahtsäge, OLIVECRONA.....	332
Darmklemme, KOCHER.....	540	Dermatom, SCHINK.....	49	Drahtschere, UNIVERSAL.....	67
Darmklemme, MAYO-ROBSON.....	541	Dermatom, SILVER.....	50	Drahtspanninstrument, DEMEL.....	315
Darmklemme, RESANO.....	542	Dermatom, WATSON.....	50	Drahtspanninstrument, LOUÏE.....	315
Darmklemme, SCUDDER.....	541	DERRA, Anastomosenklemme.....	515	Drahtumführungsnadel, DEMEL.....	315
Darmklemme, STONE-WATT.....	545	D'ERRICO, Nervwurzelhaken.....	329/2	Drahtvalven f. Bauchdeckenhalter.....	184
Darmquetschklemme, PAYR.....	548	DESCHAMPS, Unterbindungsnadel.....	218	Drahtzange TC, BERRY.....	319
		DESJARDINS, Arterienklemme.....	121	Drahtzange TC, CORWIN-HEGAR.....	319



Drahtzange TC, MAYO-HABERISSER .....	319	ERRICO, Bohrer .....	299	Fertigschläger, KUENTSCHER .....	321
Dreibackenspannfutter Handgriff .....	300	Ersatzklinge .....	49	Fiberglas-Lichtträger, KLEINSASSER .....	36
DUBOIS, gynäkologische Schere .....	63	Ersatzklinge, steril .....	50	Finger-Goniometer .....	25
DUPLAY, Hakenzange .....	582	Ersatzlämpchen .....	29, 30	Fingerringsäge, REDA .....	297
DUPLAY, Kornzange .....	134	Ersatzsägeblätter .....	230	Fingerringsäge, WALTON .....	297
DUPLEX, Stethoskop .....	23	ESMARCH, Gipsmesser .....	233	Fingersäge, LANGENBECK .....	296
DUPUY-WEISS, Tonsillennadel .....	466	ESMARCH, Staubinde .....	296	Fingerschützer, LANGENBECK .....	311
Dura-Dissektor, DAVIS .....	332	ESMARCH, Verbandschere .....	69/2	FINOCHIETTO, Bronchusklemme .....	490
Dura-Dissektor, FRAZIER .....	333	ETHICON, Clipanlagezange .....	524, 525	FINOCHIETTO, Nadelhalter .....	211
Dura-Dissektor, HOEN .....	333	EVES, Tonsillenschnürer .....	468	FINOCHIETTO, Rippensperrer .....	482, 484
Dura-Dissektor, HORSLEY .....	333	EXACTA, Blutdruckmeßgerät .....	8	FINOCHIETTO-BABY, Rippensperrer .....	482
Dura-Dissektor, MILLIGAN .....	332	Exenterationslöffel, BUNGE .....	378	FINOCHIETTO-BURFORD, Rippensperrer .....	483
Dura-Dissektor, OLIVECRONA .....	332	Extensionsbügel, BOEHLER .....	312	FINSEN, Wundhaken .....	168
Dura-Dissektor, SACHS .....	332	Extensionsbügel, KIRSCHNER .....	312	FISCH, Dissektor .....	420
Dura-Dissektor, TOENNIS .....	332	Extensionsbügel, KIRSCHNER US .....	312	FISCH, feines Häkchen .....	335
Dura-Dissektor, WOODSON .....	333	Extirpationsmeißel, ROLLET .....	374	FISCHER, Irispinzette .....	384
Dura-Haken, JACOBSON .....	335	Extraktor .....	322	FISH, Sonde .....	199
Dura-Messer, KOOS .....	335	Extraktionshaken .....	322	FISHER, Tonsillennmesser .....	466
Dura-Haken .....	335	Extraktionshaken, ARRUGA .....	375	Fistelhäkchen, EMMETT .....	594
Dura-Haken, ADSON .....	329	Extraktionshaken, I.U.D. .....	593	Fistelsonde, LOCKHART-MUMMERY .....	200
DURANTE, Fußpinzette .....	88	Extraktor, KUENTSCHER .....	322	Fistelsonde, PRATT .....	563
Dura-Schere, SCHMIEDEN-TAYLOR .....	65/1	F .....		Fixationspinzette, BARRAQUER .....	390
DUVAL, Darmfaßzange .....	539	Face-Lift-Schere, FREEMAN .....	74	Fixationspinzette, ELSCHNIG .....	389
DUVAL, Fußpinzette .....	85	Face-Lift-Schere, GORNEY .....	73	Fixationspinzette, GRAEFE .....	389
Dynamometer, COLLIN .....	25	Face-Lift-Schere, KAYE .....	73	Fixationspinzette, GREEN .....	390
E .....		Face-Lift-Schere, REES .....	73	Fixationspinzette, LESTER .....	389
ECHLIN, Hohlmeißelzange .....	240	Face-Lift-Schere, REES .....	73	Fixiergabel, BURCH .....	373
ECO "C" Diagnostik-Besteck .....	16	Fadengabel, REDA .....	221	Fixierpinzette, CASTROVIEJO .....	390
ECO "T" Diagnostik-Besteck .....	16	Fadengabel f. Tracheotomie .....	475	Fixierpinzette, COTTLE .....	410
EICKEN (KILLIAN), Spülkanüle .....	433	Fadenpinzette, McPHERSON .....	392	Fixierpinzette, GRAEFE .....	83
Ein- u. Ausschlaginstrumente .....	321	Fadenpinzette, Mod. TUEBINGEN .....	392	Fixierpinzette, KIRBY-ARTHUR .....	385
Einmal-Skalpelle, steril .....	43	Fadenpinzette, PAUFIQUE .....	392	Fixiervorrichtung, LEYLA .....	368/4
Einschläger, BENDER .....	322	Fadenschere, HEATH .....	66	Fixiervorrichtung, ROCHARD .....	186
Elektrode, monopolar .....	629	Fadenschere, LITTAUER .....	66	Flachbohrer, CUSHING .....	299
Elektrodenball-Koagulation .....	629	Fadenschere, NORTHBENT .....	66	Flachmeißel .....	259, 264, 267
Elektroden-Drahtschlinge .....	629	Fadenschere, SPENCER .....	66	Flachmeißel, HOKE .....	265
Elektroden-Koagulation .....	629	FANSLER, Proktoskop .....	564	Flachmeißel, ALEXANDER .....	259
Elektroden-Lanzette .....	629	FARABEUF, Knochenhaltezange .....	243	Flachmeißel, BRÜNNINGS-LUCAS .....	260
Elektroden-Nadel .....	629	FARABEUF, Raspator .....	274	Flachmeißel, HIBBS .....	265
Elektroden-Schlinge .....	628, 629	FARABEUF, Wundhaken .....	139	Flachmeißel, LEXER .....	263
Elevator, CHANDLER .....	282	FARABEUF-COLLIN, Raspator .....	274	Flachmeißel, PARTSCH .....	259
Elevator, ALDERDYCE .....	282	FARABEUF-LAMBOTTE, Knochenhaltezange .....	243	Flachmeißel, STILLE .....	260
Elevator, BOIES .....	277	FARRELL, Watteträger .....	203	Flachzange .....	316, 317
Elevator, CREGO .....	282	Fußpinzette .....	305	flexible Faßzange, SERPENTINE-GRASPER .....	593
Elevator, DINGMANN .....	463/3	Fußpinzette, COLLIN-DUVAL .....	85	flexible Hirnspaltelhalter, LEYLA .....	368/2
Elevator, FREER .....	434	Fußpinzette, DURANTE .....	88	flexibler Spannarm, LEYLA .....	368/3
Elevator, KEY .....	282	Fußpinzette, DUVAL .....	85	FOERSTER, Irispinzette .....	383
Elevator, LEMPERT .....	420	Fußpinzette, LERCHE .....	83	FOERSTER, Tupferzange .....	136
Elevator, McDONALD .....	283	Fußpinzette, RUSS, MODELL .....	85	FOMON, Hauthäkchen .....	447/1
Elevator, MURPHY-LANE .....	283	Fußzange .....	316	FOMON, Nasenhaken .....	447/1
Elevator, SAYRE .....	281	Fußzange, SERPENTINE-GRASPER .....	593	FOMON, Nasenraspel .....	444
Elevator, WATSON-CHEYNE .....	283	Fußzange, MARTEL .....	110	FOMON, Nasenschere .....	58
Elevatoren .....	280	Fußzange, PRATT .....	110	FOMON, Raspator .....	277
ELLIOT, Geburtszange .....	602	Fußzange, WILLET-MARTEL .....	110	FOMON, Rhinoplastschere .....	65/1
ELLIS, Fremdkörperhohlmeißel .....	374	FAULKNER, Kürette .....	449	FOMON, Septummeißel .....	441
ELSCHING, Fixationspinzette .....	389	FAURE, Biopsiezange .....	588	FOMON, Nasenraspel TC .....	445
ELSCHING, Hornhautmesser .....	373	FAURE, Peritoneumklemme .....	123	FOX, Lupuskürette .....	608
ELSCHING, Kapselpinzette .....	391	FAVALORO, Gefäßschere .....	61	FRAENKEL, Aufsatz .....	472
ELSCHING, Zyklodialsysspätel .....	379	FEHLAND, Darmklemme .....	542	FRAENKEL, Kehlkopfpolypenzange .....	471
EMMETT, Fistelhäkchen .....	594	FEILCHENFELD, Splitterpinzette .....	91	FRANCIS, Fremdkörpernadel .....	374
Endarterektomie-Stripper .....	202	FELDHEIM, Knochenhalteklammer .....	249	FRANKLIN-SILVERMANN, Biopsiekanüle .....	206
Endernagel, STEINMANN .....	307, 308	FERGUSSON, chirurgische Schere .....	66	FRAZIER, Bauchdeckenhalter .....	181
Endoskopiekorb .....	623	FERGUSSON, Saugrohr .....	337	FRAZIER, Dura-Dissektor .....	333
Endospekula, KOGAN .....	577	FERGUSSON, Gallensteinlöffel .....	533	FRAZIER, Hauthäkchen .....	149
ENGL, Gipszange .....	229	FERGUSSON, Hämorrhoidalklemme .....	109	FRAZIER, Punktionskanüle .....	337
Enukleations-Löffel, WELLS .....	378	FERGUSSON, Knochenhaltezange .....	243	FRAZIER/FERGUSSON, Saugrohr .....	337
Episiotomie-Schere, WALDMANN .....	64	FERGUSSON, Saugrohr .....	337	FREEMAN, Face-Lift-Schere .....	74
Episiotomie-Schere, BRAUN-STADLER .....	64	FERRIERA, Wundhaken .....	197	FREEMAN, Wundhaken .....	198
EPKER, Osteotome .....	464/2	FERRIS-SMITH, Laminektomie zange .....	343	FREER, Elevatorium .....	434
EPPENDORFER, Uterus-Biopsiezange .....	590	FERRIS-SMITH, chirurgische Pinzette .....	85	FREER, Hauthäkchen .....	448
ERBE, Verbindungskabel .....	633	FERRIS-SMITH-KERRISON, Bandscheibenstanze .....	344, 344/2	FREER, Mukosamesser .....	434
ERBE/SELECT, Verbindungskabel .....	633	FERRIS-SMITH-KERRISSON, zerlegbare Stanze .....	344/2	FREER, Nasenmesser .....	434
				FREER, Septumhohlmeißel .....	442/1



FREER, Septumlevator.....	437, 439	Geburtszange, SIMPSON.....	602	GOMMEL, mikro-chirurgische Pinzette.....	96
FREER, Septummeißel.....	439	Geburtszange, SIMPSON-BRAUN.....	602	GOMMEL, Mikro-Schere.....	80
FREER, Septummesser.....	434	Geburtszange, SIMPSON-LUIKART.....	603	Goniometer f. Finger.....	25
Fremdkörperfachmeißel, DIX.....	374	Geburtszange, TARNIER.....	604	Goniotomiemesser, SCHEIE.....	373
Fremdkörperhebel, BUCK.....	412	Geburtszange, WRIGLEY.....	602	Goniotomiemesser, BARKAN.....	373
Fremdkörperhebel, QUIRE.....	412	Geburtszangen.....	602 - 604	GOOD, Tonsillenschere.....	59
Fremdkörperhohlmeißel, ELLIS.....	374	Gefäßclip, BIEMER.....	361	GOODELL, Uterus-Dilatator.....	581
Fremdkörperhohlmeißel, WALTON.....	374	Gefäßclip, MEHDORN.....	362	GORNEY, Dissektor.....	277
Fremdkörperinstrument, DIX.....	380	Gefäßclip, MÜLLER.....	365	GORNEY, Face-Lift-Schere.....	73
Fremdkörperkürette, ALVIS.....	374	Gefäßclip, YASARGIL.....	345 - 356	GOSSET, Bauchdeckenhalter.....	181
Fremdkörpernadel.....	374	Gefäßdilator, DeBAKEY.....	529	GOURDET, Uteruslöffel.....	599
Fremdkörpernadel, DAVIS.....	374	Gefäßdissektor, ROBB.....	530	GRADLE, Cilienpinzette.....	395
Fremdkörpernadel, FRANCIS.....	374	Gefäßklemme, DeBAKEY.....	494 - 496	GRADLE, Ophthalmologie-Schere.....	57
Fremdkörpernadel, LA FORCE.....	374	Gefäßklemme, DIEFFENBACH.....	104	GRAEFE, Fixierpinzette.....	83
Fremdkörpernadel, LEVINSON.....	374	Gefäßklemme, LELAND-JONES.....	494	GRAEFE, Hauthäkchen.....	149
Fremdkörperzängchen, HARTMANN.....	412	Gefäßklemme, POTTS.....	492, 493	GRAEFE, Irispinzette.....	382
Fremdkörperzängchen, HARTMANN-HOFFMANN.....	412	Gefäßklemme, SATINSKY.....	491	GRAEFE, Schere.....	56
Fremdkörperzängchen, HARTMANN-WULLSTEIN.....	412	Gefäßklemmen, atrauma.....	492 - 523, 526, 527	GRAEFE, Schielhaken.....	375
Fremdkörperzängchen, STRUEMPEL.....	412	Gefäßpinzette, ADLERKREUTZ.....	84	GRAEFE, Starlöffel.....	377
Fremdkörperzange, MATHIEU.....	553/1	Gefäßpinzette, NELSON.....	89	GRAEFE, Starmesser.....	371
FRENZEL, Nystagmusbrille.....	20	Gefäßpinzette, WANGENSTEEN.....	89	GRAEFE, Cystotom.....	375
FRENZEL, Zungenspatel.....	451	Gefäßpinzette, STILLE-BARRAYA.....	88	GRAEFE, Disziionsmesser.....	372
FRIEDMAN, Hohlmeißelzange.....	234	Gefäßschere, DeBAKEY.....	61	GRAEFE, Fixationspinzette.....	389
FRIEDMAN-Mini, Hohlmeißelzange.....	234	Gefäßschere TC, DeBAKEY.....	60	GRAEFE, Schielhaken.....	375
FRIEDMANN, Spekula.....	577	Gefäßschere, DIETRICH.....	60	GRAEFE, Lidsperrer.....	370
FRITSCH, Wundhaken.....	163	Gefäßschere, FAVALORO.....	61	GRAHAM, Nervhaken.....	329
FRYKHOLM, Hohlmeißelzange.....	240	Gefäßschere, KELLY.....	61	GRAIG, Septumzange.....	426
FUCHS, Kapselpinzette.....	391	Gefäßschere, KLINKENBERG-LOTH.....	65/2	GRAVE, Scheidenspekula.....	570
FUCHSIG, Arterienklemme.....	113	Gefäßschere, POTTS-DE MARTEL.....	59	GRAY, Arterienklemme.....	121
Führungshohlsonde, KOENIG.....	221	Gefäßschere, POTTS-SMITH.....	61	GREEN, Fixationspinzette.....	390
Führungshohlsonde, KIRSCHNER.....	221	Gefäßschere, SATINSKY.....	65/2	GREEN, Hornhautdissektor.....	374
Führungshohlsonde, SCHMIEDEN-PAYR.....	221	Gefäß-Spülkanüle, SCHMID.....	338	GREEN, Muskelhäkchen.....	375
Führungshohlsonde, BRUNNER.....	221	GELPI, Bauchdeckenhalter.....	189/1, 189/2	GREEN, Wundhaken.....	160
Führungshohlsonde, PAYR.....	221	GELPI, Haken.....	193	GREEN-ARMYTAGE, Uteruszange.....	605
Führungshohlsonde, SCHMIEDEN.....	221	GEMINI, Arterienklemme.....	115	GREGORY, Profundaklemme.....	517
Führungshohlsonde, VIENNA.....	221	GERALD, anatomische Pinzette.....	86	GREVEN, Mikro-Ohrzängchen.....	414
Führungsinstrument, DE MARTEL.....	330	GERALD, chirurgische Pinzette.....	87	Griff allein f. Uterus-Biopsiezangen.....	591
Führungsnadel, REDON.....	207	GERSTER, Knochenhalteklammer.....	250	Griff f. Kehlkopfspiegel.....	473
Führungsspiß.....	321	GERZOG, Hammer.....	270	Griff f. SCHERBAK.....	575
G		Gewebefußpinzette, BROWN.....	83	Griff f. Stabinstrumente, Tracheotomie.....	475
Galeahaken, YASARGIL.....	330	Gewebefußpinzette, SINGLEY.....	88	Griff f. Meißel.....	266
GALLAHER, Antrumraspel.....	446	Gewebefußzange, CHAPUT.....	110	Griff f. Osteotome.....	266
Gallenblasenschere, THOREK.....	65/2	Gewebefußzange, COLLIN.....	110	Griff f. Skalpell.....	38 - 41
Gallengangdilator, BAKES.....	532	Gewebefußzange, TUFFIER.....	110	Griffe f. Skalpell Mini.....	41
Gallensteinlöffel, MOOR.....	532	Gewicht f. AUVARD.....	576	GROSS, Ohrlöffel.....	409
Gallensteinlöffel, DESJARDINS.....	534	Gewicht f. SCHERBAK.....	575	GROSS-MAIER, Kortzange.....	134
Gallensteinlöffel, FERGUSSON.....	533	GIERTZ-STILLE, Rippenschere.....	481	GRUBER, Ohrspekula.....	399
Gallensteinlöffel, LUER-KOERTE.....	533	GIGLI, Säge.....	332	GUILLEN, Saugraspatorium.....	433/1
Gallensteinlöffel, MAYO.....	534	GILL, Hornhautmesser.....	373	Gummibirne f. POLITZER.....	406
Gallensteinsonde, DESJARDINS.....	532	GILL, Irispinzette.....	384	Gumminge-Ligatur f. MC GIVNEY.....	568
Gallensteinsonde, MOYNIHAN.....	532	GILL-ARRUGA, Kapselpinzette.....	390	GUTHRIE, Hauthäkchen.....	149
Gallensteinsonde, MAYO.....	534	GILL-HESS, Irispinzette.....	384	GUYON, Arterienklemme.....	122
Gallensteinzange, BLAKE.....	531	GILLIES, chirurgische Pinzette.....	86	GUYON, Dilatationsbougie.....	554
Gallensteinzange, DESJARDINS.....	531	GILLIES, Hauthäkchen.....	448	GUYON, Katheter-Einführungsinstrument.....	554
Gallensteinzange, MIXTER.....	531	GILLIES, Nadelhalter.....	212	GUYON, Nierenklemme.....	122
Gallesteinzange, MAYO-BLAKE.....	531	GL-VERNET, Wundhaken.....	152	GUYTON-LUNGSGAARD, Sklerotom.....	373
GASS, Häkchen.....	376	Gipsabreißzange, WOLFF.....	233	Gynäkologie-Schere, DOYEN.....	63
GAUSS, Kopfschwarte.....	605	Gipsmesser, ESMARCH.....	233	Gynäkologie-Schere, DUBOIS.....	63
Geburtslöffel, SELLHEIM.....	607	Gipsmesser, HOPKINS.....	233	Gynäkologie-Schere, SIEBOLD.....	62
Geburtszange, BARTON.....	603	Gipsmesser, REINER.....	233	Gynäkologie-Schere, SIMS.....	62
Geburtszange, BOERMA.....	604	Gipsmesser, WIGMORE.....	229		
Geburtszange, DE LEE.....	602	Gipsäge, elektrisch.....	230	H	
Geburtszange, ELLIOT.....	602	Gipsäge, ENGEL.....	229	HABERER, Darmspatel.....	143/1
Geburtszange, KIELLAND.....	602	Gipsschere, STILLE.....	229	Hämorrhoidal-Klemme, FERGUSSON.....	109
Geburtszange, KIELLAND-LUIKART.....	603	Gipsspreizer, REDA.....	232	Hämorrhoidal-Ligatur, MC GIVNEY.....	568
Geburtszange, LUIKART.....	603	Gipsspreizer, BEESON.....	232	HAGLUND-STILLE, Gipsspreizer.....	232
Geburtszange, McLEAN.....	603	Gipsspreizer, HAGLUND-STILLE.....	232	HAGHT, Rippensperre.....	487
Geburtszange, McLEAN-LUIKART.....	603	Gipsspreizer, HENNIG.....	232	HAJEK, Hammer.....	273
Geburtszange, McLEAN-TUCKER.....	603	GLOVER, Bulldogklemme.....	103	HAJEK, Septummeißel.....	442/1
Geburtszange, McLEAN-TUCKER-LUIKART.....	603	GLOVER, Mehrzweckklemme.....	515, 518, 519	HAJEK-BALLENGER, Elevator.....	439
Geburtszange, NAEGELE.....	602	GLUCK, Rippenschere.....	480	HAJEK-KÖFLER, Stanze.....	429, 431
Geburtszange, PIPER.....	604	GOELET, Wundhaken.....	141	Häkchen, BARBARA.....	419
		GOLDMANN-FOX, Zahnfleischschere.....	67	Häkchen, CLAYMAN.....	376



Häkchen, DAY .....	409	Handgriff Dreibackenspannfutter .....	300	HIBBS, Osteotome .....	265
Häkchen, FISCH .....	335	Handgriff f. Stabinstrumente f. Tracheotomie .....	475	HIBBS, Wundhaken .....	164
Häkchen, GASS .....	376	Handwaschbürste .....	611	HILL-FERGUSON, Rektal-Spekulum .....	560
Häkchen, KUGLEN .....	376	HANK, Dilator .....	580	Hirnmesser .....	48
Häkchen, LUCAE .....	409	HANK, Uterus-Dilatator .....	580	Hirnspatel, CUSHING .....	336, 369
Häkchen, McGEE .....	419	HARGIS, Raspator .....	463/2	Hirnspatel, HEIFETZ .....	369
Häkchen, SHAMBAUGH .....	419	HARGIS, Unterkieferhaken .....	463, 463/6	Hirnspatel, OLIVECRONA .....	336
Häkchen, SINSKEY .....	376	HARGIS, Wundhaken .....	463	Hirnspatelhalter, LEYLA .....	368/2
Häkchen f. Tracheotomie .....	475	HARKEN, Aurikelklemme .....	503	HIRSCHMANN, Anuskop .....	562
Häkchen, WAGENER .....	409	HARMS, Sonde .....	381	HIRSCHMANN, Zyklodyalysespatel .....	379
Haken, BALFOUR .....	193	HARRINGTON, Bronchusklemme .....	490	Handgriff f. NABATOFF .....	201
Haken, GELPI .....	193	HARRINGTON, Haken .....	193	Hochfrequenz-Chirurgie .....	628, 629
Haken, HARRINGTON .....	193	HARRINGTON, Wundhaken .....	147	HOEN, Dura-Dissektor .....	333
Haken, KELLY .....	193	HARRINGTON-PEMBERTON, Wundhaken .....	147	HOESEL, Nadelhalter .....	213
Haken, KIRSCHNER .....	185, 187	HARTMANN, Nasenzange .....	427	HOFFER, Wundhaken .....	465
Haken, SCOVILLE .....	196	HARTMANN, Arterienklemme .....	104	HOFFMANN, Schlauchklemme .....	624
Haken, SMELLIE .....	605	HARTMANN, Ohrzängchen .....	411	Hohlmeißel .....	259, 264
Haken, TAYLOR .....	196	HARTMANN, Fremdkörperzängchen .....	412	Hohlmeißel , PARTSCH .....	259
Haken, TESSIER .....	463/3	HARTMANN, Nasenspekula .....	422	Hohlmeißel, ALEXANDER .....	259
Hakenzange, BARRET .....	582	HARTMANN, Ohrkatheter .....	408	Hohlmeißel, COBB .....	262
Hakenzange, BRAUN .....	582	HARTMANN, Ohrspekula .....	399	Hohlmeißel, HIBBS .....	265
Hakenzange, CZERNY .....	584	HARTMANN, Polypenzange .....	424	Hohlmeißel, KILLIAN .....	442/1
Hakenzange, DUPLAY .....	582	HARTMANN, Spülkanüle .....	433	Hohlmeißel, LEXER .....	263
Hakenzange, HULKA .....	583	HARTMANN, Stimmgabel .....	403	Hohlmeißel, LEXER-Mini .....	263
Hakenzange, IOWA .....	584	HARTMANN, Zungendrucker .....	452	Hohlmeißel, NOVOTEX .....	264
Hakenzange, JACOBS .....	583	HARTMANN-HALLE, Nasenspekula .....	421	Hohlmeißel, SMITH-PETERSEN .....	261
Hakenzange, JARCHO .....	583	HARTMANN-HOFFMANN, Fremdkörperzängchen .....	412	Hohlmeißel, WEST .....	442/1
Hakenzange, MUSEUX .....	583	HARTMANN-WULLSTEIN, Fremdkörperzängchen .....	412	Hohlmeißel, ZIELKE .....	264
Hakenzange, PRATT .....	584	HAUGH, Mikro-Ohrzängchen .....	414	Hohlmeißel, STILLE .....	260
Hakenzange, SCHRÖDER .....	583	Hauthäkchen, COTTLE .....	447/1	Hohlmeißelzange, FRIEDMAN .....	234
Hakenzange, SCHRÖDER .....	584	Hauthäkchen, COTTLE-NEIVERT .....	448	Hohlmeißelzange, ADSON .....	236
Hakenzange, SCHRÖDER (POZZI) .....	582	Hauthäkchen, FOMON .....	447/1	Hohlmeißelzange, BANE-HARTMANN .....	237
Hakenzange, SKENE .....	582	Hauthäkchen, FRAZIER .....	149	Hohlmeißelzange, BLUMENTHAL .....	236
Hakenzange, STAUDE-MOORE .....	582	Hauthäkchen, FREER .....	448	Hohlmeißelzange, BOEHLER .....	238
Hakenzange, TEALE .....	583	Hauthäkchen, GILLIES .....	448	Hohlmeißelzange, CLEVELAND .....	235
HALLE, scharfer Löffel .....	253	Hauthäkchen, GRAEFE .....	149	Hohlmeißelzange, ECHLIN .....	240
HALLE, Septumelelevator .....	437	Hauthäkchen, GUTHRIE .....	149	Hohlmeißelzange, FRIEDMAN-Micro .....	234
Halogenlampe .....	29	Hauthäkchen, JOSEPH .....	149	Hohlmeißelzange, FRIEDMAN-Mini .....	234
HALSEY, Nadelhalter .....	208	Hauthäkchen, KILNER .....	608	Hohlmeißelzange, FRYKHOLM .....	240
HALSTED-MOSQUITO, Arterienklemme .....	105	Hauthäkchen, KLEINERT-KUTZ .....	149	Hohlmeißelzange, JANSEN .....	237
Halteam f. LEYLA .....	368/1	Hauthäkchen, REDA .....	150	Hohlmeißelzange, KLEINERT-KUTZ .....	237
Halteklemme, ADSON .....	298	Hautschere .....	610	Hohlmeißelzange, LEMPERT .....	237
Halter für Hirnspatel, LEYLA .....	368/4	Haut-Trephinen, KEYE .....	608	Hohlmeißelzange, LUER .....	236
Halter, KALLMORGEN .....	573	HAYES, Darmklemme .....	545	Hohlmeißelzange, MARQUARDT .....	239
Halter, KRISTTELLER .....	572	HAYES, Rektum-Anastosenklemme .....	545	Hohlmeißelzange, MAYFIELD .....	238
Halterahmen .....	187	HAYES, Hysterektomieklammer .....	126	Hohlmeißelzange, MEAD .....	235
Hammer .....	270, 271, 273	HEANEY, Nadelhalter .....	210	Hohlmeißelzange, OLIVECRONA .....	237
Hammer, BERGMANN .....	272	HEANY, Biopsiekürette .....	587	Hohlmeißelzange, RUSKIN .....	239
Hammer, COLLIN .....	270	HEANY, Wundhaken .....	164	Hohlmeißelzange, SAUERBRUCH .....	240
Hammer, COTTLE .....	273	HEANY-BALLENTINE, Hysterektomieklammer .....	127	Hohlmeißelzange, SCAGLIETTI .....	240
Hammer, GERZOG .....	270	HEATH, Fadenschere .....	66	Hohlmeißelzange, SEMB .....	240
Hammer, HAJEK .....	273	HEATH, Hammer .....	273	Hohlmeißelzange, SMITH-PETERSEN .....	238
Hammer, HEATH .....	273	HEBRA, Chalazionskürette .....	377	Hohlmeißelzange, STELLBRINK .....	234
Hammer, KIRK .....	270	HEGAR, Uterus-Dilatator .....	578, 579	Hohlmeißelzange, ZAUFAL-JANSEN .....	238
Hammer, LUCAE .....	271	HEGENBARTH, Wundklammerpinzette .....	224	Hohlmeißelzange, LEKSELL (STILLE) .....	240
Hammer m. Ferrozellgriff .....	272	HEIFETZ, Hirnspatel .....	369	Hohlmeißelzange, STILLE-LUER .....	239
Hammer, MEAD .....	271	HEIMING, Nierensteinzange .....	536	Hohlmeißelzange, STILLE-RUSKIN .....	239
Hammer, OMBREDANNE .....	273	HEISS, Arterienklemme .....	112	Hohlsonde .....	199
Hammer, PARTSCH .....	271	HEISTER, Mundsperrer .....	454	Hohlsonde, BRODIE .....	199
Hammer, QUISLING .....	271	HENKE, Tonsillenelevator .....	465	Hohlsonde, DOYEN .....	199
Hammer, WILLIGER .....	271	HENLEY, Wundspreizer .....	170	Hohlsonde, NELATON .....	199
Hämorrhoidal-Ligator .....	568	HENNIG, Gipsspreizer .....	232	HOHMANN, Knochenhebel .....	284, 285
Hämorrhoidal-Ligator, RUDD .....	568	HEPP-SCHIEDL, Mikro-Schere .....	78	HOHMANN-Mini, Knochenhebel .....	286
Hämorrhoidal-Zange, MC GIVNEY .....	568	HERRICK, Nierenstielklemme .....	123	HOKE, Flachmeißel .....	265
Hämorrhoidal-Zange, HEYWOOD-SMITH .....	567	HESS, Irispinzette .....	384	HOKE, Osteotome .....	265
Handbohrapparat, MOORE .....	298	HESS, Kapselpinzette .....	391	HOLINGER, OP-Laryngoskop .....	37
Handbohrapparat, BUNELL .....	299	HESS, Nervwurzelhaken .....	329/1	HOLLINGER, Lichtträger .....	37
Handbohrapparat, HUDSON .....	299	HEYMANN, Nasenschere .....	58	HOLSHER, Nervwurzelhaken .....	329/1
Handbohrapparat, KIRSCHNER .....	299	HEYMANN, Septumzange .....	425	HOLTH, Kapselstanze .....	380
Handbohrapparat, RALK .....	300	HEYMANN-KNIGHT, Polypenzange .....	425	HOLZBACH, Hysterektomieklammer .....	126
Handbohrapparat, REDA .....	300	HEYWOOD-SMITH, Hämorrhoidalzange .....	567	HOLZHEIMER, Wundhaken .....	168
Handbohrapparat, STILLE .....	298	HIBBS, Flachmeißel .....	265	HOPKINS, Gipsmesser .....	233
Handgriff .....	300	HIBBS, Hohlmeißel .....	265	HORGAN, Valve f. Bauchdeckenhalter .....	183

HORIZON, Clipanlegezange.....	524, 525	Irisspatel, WECKER.....	378	Kapsel-faßzange, MILLIN.....	550, 551
Hornhautdissektor, GREEN.....	374, 375	ISRAEL, Wundhaken.....	162	Kapselpinzette, ARRUGA.....	391
Hornhautdissektor, PATON.....	373	ITERSON, Trachealhaken.....	477	Kapselpinzette, CASTROVIEJO.....	391
Hornhautmesser, ELSCHNIG.....	373	IVES-FANSLER, Anuskop.....	562	Kapselpinzette, ELSCHNIG.....	391
Hornhautmesser, GILL.....	373	IWANSON, Meßgerät.....	624	Kapselpinzette, FUCHS.....	391
Hornhautmesser, SATO.....	373			Kapselpinzette, GILL-ARRUGA.....	390
Hornhautmesser, TOOK.....	373	<b>J</b>		Kapselpinzette, HESS.....	391
Hornhautschaber, KUHN.....	373	JACKSON-BURROWS, Bauchdeckenhalter.....	189/2	Kapselpinzette, KALT.....	391
Hornhautschere, CASTROVIEJO.....	79	JACKSON, Kehlkopf-pinzette.....	471	Kapselpinzette, SCHWEIGGER.....	391
HORSLEY, Dura-Dissektor.....	333	JACKSON, Laryngoskop.....	37	Kapselpinzette, TERSON.....	391
HÖSEL, Wundhaken.....	167	JACKSON, Pinzette.....	471	Kapselschere, RESANO.....	53/2
HOUSE, Kürette.....	420	JACKSON, Scheidenspekula.....	573	Kapselstanze, HOLTH.....	380
HOUSE, Mikro-Meßsonde.....	420	JACKSON, Sehnenfaßzange.....	292	Kathetereinführungsinstrument, GUYON.....	554
HOUSE, Saugrohr.....	337/2	JACKSON, Trachelhaken.....	476	Kathetereinführungzange, MAGILL.....	28
HOWARTH, Septumelevator.....	438	JACOBS, Hakenzange.....	583	Katheterklemme, COOLEY.....	510
HUBER, Universalgriff.....	472	JACOBSON, Arterienklemme.....	105	KAYE, Face-Lift-Schere.....	73
HUDSON, Handbohrapparat.....	299	JACOBSON, Dura-Haken.....	335	Kegel f. SCHULTZE Salpingograph.....	596
HUDSON, T-Handgriff.....	300	JACOBSON, Knopfsonde.....	335	Kehldeckelhalter, REICHERT.....	471
HULKA, Hakenzange.....	583	JACOBSON, Nadelhalter.....	215	Kehlkopfkanüle.....	470
HUMBY, Dermatom.....	50	JACOBSON, scharfer Löffel.....	257	Kehlkopf-pinzette, JACKSON.....	471
HUNTER, Splittlerpinzette.....	465	JAEGER, Lanzenmesser.....	372	Kehlkopfpolyenzange, FRAENKEL.....	471
HURD, Tonsillen-Dissektor.....	465	JAEGER, Lidplatte.....	371	Kehlkopfpolyenzange, JURASZ.....	471
Hypophysenkürette.....	334	JAMESON, Schielhaken.....	375	Kehlkopfspiegel.....	473
Hypophysenzange.....	341	JAMESON, Strabismus-pinzette.....	385	Kehlkopfspiegel, MICHEL.....	423
Hypophysenpinzette, ADSON.....	334	JANSEN, Hohlmeißelzange.....	237	Kehlkopfspiegel-Griff.....	473
Hypophysenpinzetten.....	334	JANSEN, Nasenpinzette.....	424	Kehlkopfspritze.....	470
Hysterektomieschere, WERTHEIM.....	63	JANSEN, scharfer Löffel.....	257	KEINASSER, OP-Laryngoskop.....	35
Hysterektomie-klemme, HOLZBACH.....	126	JANSEN, Wundhaken.....	168	KEITH, Nadel.....	223
Hysterektomie-klemme, SEGOND-LANDAU.....	125	JANSEN-GRUENWALD, Nasenpinzette.....	424	KELLY, Anuskop.....	562, 563
Hysterektomie-klemme, HEANEY.....	126	JARCHO, Hakenzange.....	583	KELLY, Arterienklemme.....	106
Hysterektomie-klemme, HEANY-BALLEN-TINE.....	127	JAVID, Carotis-Shuntklemme.....	511	KELLY, Gefäßschere.....	61
Hysterektomie-klemme, ROGERS.....	127	JENNINGS, Mundsperrler.....	454	KELLY-GRIP, Wundhaken.....	142
Hysterektomie-klemme, WERTHEIM.....	124, 128	JENSEN, Augenkanüle.....	394	KELLY, Proktoskop.....	563, 564
Hysterektomie-klemme, SEGOND.....	125	JOBSON-HORNE, Watteräger.....	203	KELLY, Uterus-Polyenzange.....	585
		JOHNS-HOPKINS, Anlegezange.....	104	KELLY, Wundhaken.....	164, 193
<b>I</b>		JOHNS-HOPKINS, Arterienklemme.....	120	KELLY-RANKIN, Arterienklemme.....	106
I.U.D., Extraktionshaken.....	593	JOHNS-HOPKINS, Bulldogklemme.....	104	Keratoplastik-Messer, BARRAQUER.....	373
Imbusschlüssel.....	231/3	JOHNSON, Nadelhalter.....	211	Keratoplastik-Messer PAUFIQUE.....	373
Impaktor.....	322	JONES, Tuckklemme.....	132	KERN, Knochenhalte-zange.....	244
INGE, Wirbelkörperspreizer.....	339	JONES-CLIP, Tuckklemme.....	132	KERRISON, Stanze.....	428
Injektionskanüle.....	36	JORGENSEN, Präparierschere.....	53	KEVORKIAN, Biopsiekürette.....	587
INSTRU-CARE, Instrumentenöl.....	634	JOSEF, Nasenmesser.....	434, 435	KEVORKIAN, Uterus-Biopsiezange.....	589, 591
Instrumente f. Tracheotomie.....	475	JOSEPH (LEWIS), Nasenraspel.....	443	KEVORKIAN-PACIFIC, Uterus-Biopsiezange.....	592
Instrumentenbox.....	617	JOSEPH, chirurgische Schere.....	54	KEY, Elevator.....	282
Instrumentenkasten.....	617	JOSEPH, Hauthäkchen.....	149	KEYES, Trepheine.....	608
Instrumentenöl, INSTRU-CARE.....	634	JOSEPH, Nasenmesser.....	434	Kieferhöhlenstanze, HAJEK-KOFLER.....	429, 431
Insufflationskanüle, VERESS.....	206	JOSEPH, Nasenraspel.....	443	Kieferhöhlenstanze, KERRISON.....	428
Intraorale Retraktoren.....	463/1, 463/4	JOSEPH, Nasensäge.....	446	Kieferhöhlentroktr, COAKLEY.....	204
Inzisions-schere.....	52	JOSEPH, Raspator.....	277	Kieferhöhlentroktr, DOUGLAS.....	204
IOWA, Hakenzange.....	584	JOSEPH, Septumelevator.....	437	Kieferhöhlentroktr, LICHTWITZ.....	204
IOWA, Nadelführer.....	206	JUDD-ALLIS, Darm-faßzange.....	538	Kieferhöhlentroktr, PIERCE.....	204
IRIS, Schere.....	54	JUDD-MASSON, Blasenwund-spreizer.....	552	KIELLAND, Geburtszange.....	602
Irisschere, KNAPP.....	55	JUERS, Mikro-Ohrzängchen.....	414	KIELLAND-LUIKART, Geburtszange.....	603
Irisschere, LITTLER.....	55	JURASZ, Kehlkopf-polyenzange.....	471	KILLIAN, Hohlmeißel.....	442/1
IRIS, Supercutschere.....	72	JURASZ, Zange.....	471	KILLIAN, Nasenspekula.....	423
Irishäkchen, O'CONNOR.....	375			KILLIAN, Septumelevator.....	438, 439
Irishäkchen, WIENER.....	375	<b>K</b>		KILLIAN, Septumschere.....	471
Irismesser, DEAN.....	372	Kabel, bipolar.....	633	KILLIAN, Spükanüle.....	433, 433/1
Irismesser, KNAPP.....	372	KABERSKE, Pulverbläser.....	405	KILLIAN-CLAUS, Septumhohlmeißel.....	442/1
Irismesser, ZIEGLER.....	372	KADER, Bauch- u. Darm-spatel.....	143/1	KILNER, chirurgische Schere.....	54
Irispinzette, BARRAQUER.....	384	KALLMORGEN, Halter.....	573	KILNER, Hauthäkchen.....	608
Irispinzette, BARRAQUER-KATZIN.....	384	KALLMORGEN, Scheidenspekula.....	573	KILNER, Nadelhalter.....	212
Irispinzette, BISHOP-HARMAN.....	386	KALLMORGEN, Spekula.....	573	KILNER, Nasenhaken.....	447/1
Irispinzette, BONN.....	387	KALT, Kapselpinzette.....	391	KILNER, Supercutschere.....	72
Irispinzette, FISCHER.....	384	KALT, Nadelhalter.....	214	KILNER-DOUGHTY, Mundsperrler.....	456
Irispinzette, FOERSTER.....	383	KALT-ARRUGA, Nadelhalter.....	214	Kinder-Atrauma-Gefäßklemme.....	526, 527
Irispinzette, GILL.....	384	Kaltlichtklammer für Amnioskope.....	601	Kinder-Aortaklemme, SUBRAMANIAN.....	521
Irispinzette, GILL-HESS.....	384	Kaltlichtträger, HOLLINGER.....	37	Kinder-Aortaklemme, SUBRAMANIAN-MINITURE.....	521
Irispinzette, GRAEFE.....	382	Kaltlichtträger, JACKSON.....	37	Kinder-Gefäßklemme, SUBRAMANIAN.....	521
Irispinzette, HESS.....	384	KANE, Nabelschnurklemme.....	605	Kinder-Gefäßklemme, SUBRAMANIAN-MINITURE.....	521
Irispinzette, TROUTMAN.....	384	KANTROWITZ, Arterienklemme.....	119/1	Kinder-Gefäßklemmen.....	527
Irispinzette, STEVENS.....	383	Kanüle f. Sauggriff ZÖLLNER u. WULLSTEIN.....	337/1	Kinder-Gefäßklemmen, atrauma.....	523
Irisspatel, CULLER.....	378	Kappen-zange, REDA.....	615	Kinder-Gefäßklemmen, COOLEY.....	522







Langenmesser, JAEGER.....	372	LISTON, Amputationsmesser.....	44	MASING, Nasenhaken.....	447
Lärmtrommel, BARANY.....	405	LISTON, Knochensplitterzange.....	241	MASSING-NEIVERT, Nasenhaken.....	447
LARSEN, Sehnenfußpinzette.....	292	LITTAUER, Cilienpinzette.....	395	MASSON, Nadelhalter.....	210
Laryngoskop-Kaltlichtgriff, Batteriegriff.....	33	LITTAUER, Fadenschere.....	66	Maßstab, Metall.....	25
Laryngoskop-Warmlicht, Batteriegriff.....	32	LITTAUER, Ohrzängchen.....	411	Mastdarm-Biopsiezange, TURREL.....	567
Laryngoskop-Warmlichtgriff mit Trafo-Anschluß.....	34	LITTAUER, Polypenzange.....	425	Mastdarm-Biopsiezange, YEOMAN.....	566, 567
Laryngoskop, HOLLINGER.....	37	LITTLE, Wundhaken.....	157	Mastdarm-Spekula, ALAN-PARKS.....	561
Laryngoskop, JACKSON.....	37	LITTLER, Irisschere.....	55	Mastdarm-Spekula, BARR.....	559
Laryngoskop, MILLER.....	30	LITTLEWOOD, Darmfaßzange.....	538	Mastdarm-Spekula, BODENHAMMER.....	559
Lateralspreizer.....	569	LOCKHART-MUMMERY, Fistelsonde.....	200	Mastdarm-Spekula, CZERNY.....	559
LAWRENCE, Arterienklemme.....	119	LOCKLIN, Zahnfleischschere.....	69	Mastdarm-Spekula, MATHIEU.....	560
LEBSCHKE, Sternummeißel.....	267	LOCKWOOD-ALLIS, Darmfaßzange.....	538	Mastdarm-Spekula, PRATT.....	559
LEES, Bronchusklemme.....	504	Löffelzängchen.....	416	Mastdarm-Spekula, SIMS.....	559
LEGUE, Blasenwundspreizer.....	553	LONDON-COLLEGE, Zahnpinzette.....	93	Mastdarm-Spekula, SCHULZE-BERGMANN.....	560
LEGUJEU, Blasenpatel.....	552	LOPEZ-REINKE, Tonsillen-Dissektor.....	465	MASTIN, Muskelklemme.....	479
LEKSELL (STILLE), Hohlmeißelzange.....	240	LORENZ, Verbandschere.....	70	MATHIEU, Fremdkörperzange.....	553/1
LELAND-JONES, Gefäßklemme.....	494	LORNA, Tuchklemme.....	133	MATHIEU, Mastdarmspekula.....	560
LEMPERT, Elevator.....	420	LOUTE, Drahtspanninstrument.....	315	MATHIEU, Nadelhalter.....	213
LEMPERT, Hohlmeißelzange.....	237	LOVE, Nervwurzelhaken.....	329/2, 330	MATHIEU, Wundhaken.....	141
LEMPERT, scharfer Löffel.....	256	LOVE, Wundhaken.....	465	MATHIEU-OLSEN, Nadelhalter.....	212
LERCHE, Fußpinzette.....	83	LOVE-GRUENWALD, Laminektomiezange.....	340	MATSON, Raspator.....	279
LERICHE, Arterienklemme.....	111	LOVELACE, Arterienklemme.....	109	MATSON-ALEXANDER, Raspator.....	279
LERICHE, Bauchspatel.....	143/2	LOVELACE, Lungenfaßzange.....	490	MAUNDER, Mundkeil.....	459
LERICHE, Darmspatel.....	143/2	LOWER, Arterienklemme.....	120	MAXI-GRASPER, Uterus-Biopsiezange.....	593
LESTER, Fixationspinzette.....	389	LOWMAN, Knochenhalteklammer.....	249	MAYFIELD, Hohlmeißelzange.....	238
LEVINSON, Fremdkörpernadel.....	374	LOWMAN-HOGLUND, Knochenhalteklammer.....	249	MAYO, Gallensteinlöffel.....	534
LEWIN, Knochenhaltezange.....	246	LUBET-BARBON, Nasentamponzange.....	424	MAYO, Gallenseinsonde.....	534
LEWIS, Nasenraspel.....	443	LUC, Septumzange.....	426	MAYO, Pinzette.....	89
LEXER-BABY, Präparierschere.....	53	LUCAE, Häkchen.....	409	MAYO, Präparierschere.....	52
LEXER, Flachmeißel.....	263	LUCAE, Hammer.....	271	MAYO, Sterilisierklammer.....	227, 624
LEXER, Hohlmeißel.....	263	LUCAE, Ohrpinzette.....	410	MAYO, Supercutschere.....	71
LEXER-Mini, Hohlmeißel.....	263	LUCAE, Parazentese-Nadel.....	408	MAYO, Zungenspatel.....	451
LEXER, Präparierschere.....	53	LUCAE, Stimmgabel.....	404	MAYO-ADAMS, Wundspreizer.....	171
LEYLA, Retraktor-System.....	368	LUER, Hohlmeißelzange.....	236	MAYO-BLAKE, Gallensteinzange.....	531
LICHTENBERG, Nadelhalter.....	213	LUER, Trachealkanüle.....	479	MAYO-COLLINS, Wundhaken.....	141
Lichtleiterkabel-Siebkorb.....	623	LUER, Wundhaken.....	140	MAYO-HABERISSER, Drahtzange.....	319
Lichtträger.....	37	LUER-KOERTE, Gallensteinlöffel.....	533	MAYO-HEGAR, Nadelhalter.....	209
Lichtträger, JACKSON.....	37	Luftdusche, POLITZER.....	406	MAYON-GUYON, Arterienklemme.....	122
Lichtträger, HOLLINGER.....	37	Luftpumpe.....	295	MAYO-NOBLE, Präparierschere.....	52
LICHTWITZ, Kieferhöhlentroker.....	204	LUIKART, Geburtszange.....	603	MAY, Ophthalmoskop UNI II.....	14
LICHTWITZ, Punktionskanüle.....	433	LUIKART-BILL, Zughebel.....	604	MAYO-ROBSON, Darmklemme.....	541
Lidplatte, JAEGER.....	371	Lungenfaßzange, LOVELACE.....	490	MAYO-STILLE, Präparierschere.....	52
Lidsperre, BARRAQUER.....	370	Lungenschere, CRAFOORD.....	65/2	MAYO-STILLE, Supercutschere.....	71
Lidsperre, BOWMAN.....	370	Lungenspatel.....	489	MC DONALD, Elevator.....	283
Lidsperre, CLARK.....	370	Lungenspatel, ALLISON.....	489	McGIVNEY, Hämorhoidal-Ligator.....	568
Lidsperre, CRITCHETT.....	370	LUNGSSGAARD, Sklerotom.....	373	McGIVNEY, Hämorhoidal-Zange.....	568
Lidsperre, MURDOCK.....	370	LUNIATSCHEK, Tamponstopfer.....	465	McINDOE, Knochensplitterzange.....	241
Lidsperre, SMITH.....	370	Lupuskürette, FOX.....	608	McKENZIE, Bohrer.....	299
Lidsperre, ARRUGA.....	370	Lupuskürette, PIFFARD.....	608	McCULLOUGH, Strabismuspinzette.....	385
Lidsperre, CASTROVIEJO.....	371	M.....		McGEE, Häkchen.....	419
Lidsperre, GRAEFE.....	370	Magen-Darmnähapparat, PETZ.....	549	McGEE, Mikro-Ohrzängchen.....	414
Lidsperre, LANCASTER.....	371	Magen-Darmklemme, MIKULICZ.....	543	McINDOE, Knorpelschere.....	65/1
Lidsperre, LIEBERMAN.....	371	Magenquetschklemme, LANE.....	547	McINDOE, Pinzette.....	85
Lidsperre, LISTER-BURCH.....	370	MAGIL, Katheterzange.....	28	McINTYRE, Augankanüle.....	394
Lidsperre, MELLINGER.....	370	MAIER, Kornzange.....	134	McIVOR, Mundsperrler.....	457
Lidsperre, MELLINGER-AXENFELD.....	370	MALTZ (COTTLE), Nasenraspel.....	444	McKENTY, Septumlevator.....	437, 438
Lidsperre, MUELLER.....	371	MALTZ, Nasenraspel.....	443	McKENZIE, Anlegezange.....	326
Lidsperre, PARK.....	371	Mandrin f. RUMEL-BELMONT.....	528	McLEAN, Geburtszange.....	603
Lidsperre, STEVENSON.....	371	Manometer.....	295	McLEAN-LUIKART, Geburtszange.....	603
Lidsperre, WEEK.....	370	Manometer f. SCHULTZE.....	596	McLEAN-TUCKER, Geburtszange.....	603
Lidsperre, WILLIAMS.....	370	Markierungsinstrument, CONNIN-AMSLER.....	380	McLEAN-TUCKER-LUIKART, Geburtszange.....	603
Lidsperre, ZIEGLER.....	371	Markraumborner.....	322	McPHERSON, Fadenpinzette.....	392
LIEBERMAN, Lidsperre.....	371	MARQUARD, Hohlmeißelzange.....	239	MEAD, Hammer.....	271
Ligatur-Gummiringe f. MC GIVNEY.....	568	MARSHIK, Tonsillenfaßpinzette.....	468	MEAD, Hohlmeißelzange.....	235
Ligaturklemme, DeBAKEY.....	499, 500	MARTEL, Faßzange.....	110	Medizinbecher.....	621
Linsenhaken, STEVENS.....	375	MARTIN, Beckenzirkel.....	605	Medizinlöffel.....	268, 621
Linsenmanipulator, BECHERT.....	379	MARTIN, Cartilageschere.....	65/1	MEEKER, Arterienklemme.....	119
Lippenhalter.....	453, 451	MARTIN, Knochenhaltezange.....	246	MEHDORN, Anlegepinzette.....	362
Lippenhalter, CAWOOD-MINNESOTA.....	451	MARTIN, Uterussonde.....	586	MEHDORN, Gefäßclip.....	362
LISTER (SINUS), Tupferzange.....	137	MARTIN, Verbindungskabel.....	633	Mehrzweck-Gefäßklemme.....	520
LISTER, Supercutschere.....	72	MARTIN, Wundspreizer.....	175/1	Mehrzweck-Gefäßklemme, BAINBRIDGE.....	495
LISTER, Verbandschere.....	69/1	MARTINI, scharfer Löffel.....	257	Mehrzweck-Gefäßklemme, GLOVER.....	515, 518, 519
LISTER-BURCH, Lidsperre.....	370			Mehrzweck-Gefäßklemme, DeBAKEY.....	495, 508, 514 - 517



Mehrzweckschale.....	620	MILLIN, Prostatafaßzange.....	550, 551	Nabelschnurschere, MOD. USA.....	64
Meißel, BRUNETTI.....	268	Mini- Bulldogklemme, DeBAKEY-DIETHRICH .....	101	Nabelschnurschere, SCHUMACHER .....	64
Meißelklinge.....	266	Mini-Schnellkupplungshandgriff .....	301	Nadel, BARBARA .....	419
MELLINGER, Lidsperrerr .....	370	Mini-Skalpell .....	41	Nadel, ROSEN .....	419
MELLINGER-AXENFELD, Lidsperrerr .....	370	Mini-Skalpellgriffe.....	41	Nadel, REVERDIN.....	220
MENGHINI, Biopsiekaniüle .....	206	Mini-Bulldogklemme, DIETRICH .....	101	Nadel, YOUNG-BOOMERANG .....	220
Meniskusshaken, BLOUNT .....	289	Mini-Bulldogklemmen, DeBAKEY-DIETHRICH .....	101	Nadeldose .....	615
Meniskusmesser, NEFF .....	292	MINI-LAMBOTTE, Flachmeißel .....	262	Nadelelektrode, monopolar .....	628, 629
Meniskusmesser, SMILLIE .....	292	MINI-TOWNSEND-DOWN, Biopsiezange .....	591	Nadelführer, IOWA .....	206
MERCEDES, Thoraxsperrerr .....	489	MINI-TOWNSEND-UP, Biopsiezange .....	591	Nadelführer, BARRAQUER .....	216, 217
MERIAM, Zahnpinzette .....	93	MIXTER, Arterienklemme S-gebogen .....	116	Nadelführer, BARRAQUER -TROUTMAN .....	216
Meßbecher .....	620	MIXTER, Gallensteinzange .....	531	Nadelführer, MICROVASCULAR .....	210
Messer, Amputation .....	44	MIXTER-BABY, Arterienklemme.....	119/1	Nadelführer, ADSON .....	211
Messer, Zwischenknochen.....	44	MIXTER-O'SHAUGNESSY, Arterienklemme .....	119/2	Nadelführer, ARRUGA .....	214
Messer, PLESTER.....	418	Mobilisierhaken, TESSIER.....	463/3	Nadelführer, BABY-WEBSTER .....	208
Messer, ROSEN .....	418	MOD. BONN, Nahtpinzette .....	387	Nadelführer, BAUMGARTNER .....	208
Messer, SCHUKNECHT.....	418	MOD. TÜBINGEN, Fadenpinzette .....	392	Nadelführer, BOYNTON .....	214
Messer, TABB .....	418	MOD. TÜBINGEN, Nahtpinzette .....	387	Nadelführer, BOZEMANN .....	211
Messer, WULLSTEIN.....	418	MOD. MÜNCHEN, Biopsiekürette .....	587	Nadelführer, BROWN .....	209
Meißgerät, IWANSON .....	624	MOD. VIENNA, Nasenspekula .....	421	Nadelführer, CASTROVIEJO .....	215, 216
Meißinstrumente.....	594	MOELTGEN, Winkelmesser .....	25	Nadelführer, CASTROVIEJO-Micro .....	215
Meißscheiber .....	26	MOGEN, Beschneidungsgerät .....	556	Nadelführer, CASTROVIEJO-Standard .....	216
Meißsonde, HOUSE .....	420	MOLLISON, Wundspreizer .....	171	Nadelführer, COLLIER .....	208
Messzirkel, CASTROVIEJO .....	380	MOLT, Rasperatorium .....	276	Nadelführer, CRILE .....	213
Metallkatheter .....	555	Monopolare Elektrode .....	629	Nadelführer, CRILE-MURRAY .....	209
Metallkatheter, COXETER.....	555	MOOR, Gallensteinlöffel.....	532	Nadelführer, CRILE-WOOD .....	209
METZENBAUM, chirurgische Schere S .....	54	MOORE, Handbohrapparat .....	298	Nadelführer, DE BAKEY .....	210
METZENBAUM FINO, Präparierschere TC .....	53	MOORFIELD, Nahtpinzette .....	392	Nadelführer, DERF .....	208
METZENBAUM, Nadelhalter .....	211	MORGAN, Proktoskop .....	565	Nadelführer, FINOCHIETTO .....	211
METZENBAUM, Präparierschere .....	53/1	MORTIZ-SCHMIDT, Zungenspatel .....	452	Nadelführer, GILLIES .....	212
METZENBAUM, Supercuttschere .....	71	MORRIS, Wundhaken .....	164	Nadelführer, HALSEY .....	208
METZENBAUM, Präparierschere TC .....	53/1	MORRIS-DeBAKEY, Aortaklemme .....	506	Nadelführer, HEANEY .....	210
MEYERDING, Laminektomiespreizer .....	180	MORSE, Rippenspererr .....	484	Nadelführer, HOESSEL .....	213
MEYERDING, Wundhaken .....	157, 177	MORSE-FAVALORO, Rippenspererr .....	484	Nadelführer, JACOBSON .....	215
MEYERDING, Wundspreizer .....	180	MOYNIHAN, Arterienklemme .....	120	Nadelführer, JOHNSON .....	211
MEYHOEFER, Chalasionskürette .....	377	MOYNIHAN, Gallensteinsonde .....	532	Nadelführer, KALT .....	214
MICHEL, Kehlkopfspiegel .....	423	MOYNIHAN, Tuchklemme .....	133	Nadelführer, KALT-ARRUGA .....	214
MICHEL, Wundklammern.....	224	MUELLER, Lidsperrerr .....	371	Nadelführer, KILNER.....	212
MICHEL, Wundklammerpinzette .....	224	Mukosamesser, FREER .....	434	Nadelführer, LANGENBECK .....	213
MICHEL, Wundklammerzange .....	224	MÜLLER, Approximator .....	364	Nadelführer, LICHTENBERG .....	213
Micro-FRIEDMANN, Hohlmeißelzange.....	234	MÜLLER, Gefäßclip .....	365	Nadelführer, MASSON .....	210
Micro-HARTMANN, Arterienklemme.....	104	Mundkeil, MAUNDER .....	459	Nadelführer, MATHIEU .....	213
MICROVASCULAR, Nadelhalter .....	210	Mundsperrerr, DAVIS-MEYER .....	457	Nadelführer, MATHIEU-OLSEN .....	212
MIDDELDORPF, Wundhaken.....	160	Mundsperrerr, DAVIS-BOYLE .....	455	Nadelführer, MAYO-HEGAR .....	209
MIDDLETON-JANSEN, Septumzange .....	430	Mundsperrerr, DENHART .....	454	Nadelführer, METZENBAUM .....	211
mikro-chirurgische Pinzette .....	94	Mundsperrerr, DINGMANN .....	456	Nadelführer, NEIVERT .....	208
mikro-chirurgische Pinzette, GOMEL .....	96	Mundsperrerr, HEISTER.....	454	Nadelführer, OLSEN-HEGAR .....	212
Mikro-Faßzängchen, Rohrschaft .....	415	Mundsperrerr, JENNINGS .....	454	Nadelführer, RYDER.....	210
Mikro-Kanüle f. ZÖLLNER und WULLSTEIN Sauggriff .....	337/1	Mundsperrerr, KILNER-DOUGHTY .....	456	Nadelführer, SAROT .....	211
Mikro-Löffelzängchen, WULLSTEIN .....	416	Mundsperrerr, McIVOR .....	457	Nadelführer, STEVENS.....	214
Mikro-Löffelzängchen, Rohrschaft .....	416	Mundsperrerr, ROSER-KOENIG .....	454	Nadelführer, WANGENSTEEN .....	210
Mikro-Meßsonde, HOUSE.....	420	Mundsperrerr, DOYEN-JANSEN (MOLT) .....	454	Nadelführer, WEBSTER .....	208
Mikro-Ohrscheren, BELLUCCI .....	413, 417	MURDOCK, Lidsperrerr .....	370	Nadelführer, BABY-OLSEN-HEGAR .....	212
Mikro-Ohrschere, SHEA .....	413	MURPHY, Wundhaken .....	156	Nadelführer, STRATTE .....	212
Mikro-Ohrzängchen .....	413 - 416	MURPHY-LANE, Elevator .....	283	Nadeln, chirurgische.....	222
Mikro-Ohrzängchen, COS .....	414	MUSEUX, Hakenzange.....	583	NAEGELE, Geburtszange.....	602
Mikro-Ohrzängchen, DIETER .....	414	Muskelhaken .....	267	Nagelausreisszange, RADOLF .....	297
Mikro-Ohrzängchen, GREVEN .....	414	Muskelklemme, MASTIN .....	479	Nagelfeile.....	610
Mikro-Ohrzängchen, HAUGH .....	414	Muskelpinzette, TROUTMAN .....	389	Nagelhautzange .....	610, 613
Mikro-Ohrzängchen, JUERS .....	414	Muskelpinzette, BERKE .....	389	Nagelscheren .....	609, 614
Mikro-Ohrzängchen, McGEE .....	414	Muskelpinzette, PRINCE .....	387	Nagel-Set .....	609
Mikro-Rohrschaftzange REDA .....	474	Muskelpinzette, SNELLEN .....	393	Nagelspaltzange, ANVIL .....	613
Mikro-Schere, GOMEL .....	80	Mutterschlüssel .....	313	Nagelsplittinstrument .....	612/1
Mikro-Schere, HEPP-SCHUIDEL.....	78	MYLES, Nasenzange .....	427	Nagelzange, TURNBULL .....	609
MIKULICZ, Darmklemme .....	543	Myomheber, DOYEN .....	594	Nagelzangen .....	609, 612/2, 613, 614
MIKULICZ, Peritoneumklemme.....	123	Myommesser, SEGOND .....	594	NAGER, Tonsillennadel.....	466
MIKULICZ, Wundhaken.....	163	Myrtenblattsonde .....	199	NAGER, Wundhaken .....	465
MIKULICZ-BABY, Peritoneumklemme .....	123	N		Nahtpinzette, CASTROVIEJO .....	392
MILLER, Laryngoskop .....	90	NABATOFF, Krampfaderbesteck .....	201	Nahtpinzette, MOD. BONN .....	387
MILLER, Nasenraspel .....	444	Nabelschnurklemme, COLLIN .....	605	Nahtpinzette, MOD. TUEBINGEN .....	387
MILLIGAN, Dura-Dissektor .....	332	Nabelschnurklemme, KANE .....	605	Nahtpinzette, MOORFIELD .....	392
MILLIN, Blasenspererr .....	552, 553	Nabelschnurklemme, BUSCH .....	64	Nahtpinzette, St. MARTIN .....	392
MILLIN, Kapselßaßpinzette .....	550, 551			Nasenflügelhäkchen, LANGE .....	448





Nasenhaken, CONVERSE .....	448	Neuro-chirurgische Schere.....	65	Opthalmoskop, MAY UNI II .....	14
Nasenhaken, AUFRICHT .....	447	Neuro-chirurgische Schere, STRULLY .....	65	OP-Laryngoskop, KLEINSASSER .....	35
Nasenhaken, COTTLE .....	447, 447/1	NEWS, Trachealhaken .....	477	OP-Laryngoskop, HOLLINGER .....	37
Nasenhaken, FOMON .....	447/1	Nierenklemme, GUYON .....	122	OP-Laryngoskop, JACKSON .....	37
Nasenhaken, KILNER .....	447/1	Nierenschale .....	619	Organmesser .....	48
Nasenhaken, MASING .....	447	Nierensteinzange, HEIMING .....	536	Organ- und Gewebefäßzange, atrauma .....	111
Nasenhaken, MASING-NEIVERT .....	447	Nierensteinzange, RANDALL .....	535	oscillierende Gipsäge .....	230
Nasenmeißel, WEST .....	442/1	Nierensteinklemme, HERRICK .....	123	oscillierende Gipsäge mit Stababsauger .....	231
Nasennmesser, FREER .....	434	Nierenstiellklemme, WERTHEIM-CULLEN .....	125	Osteotom, MINI-LAMBOTTE .....	262
Nasennmesser, JOSEPH .....	434, 435	NISSEN, Arterienklemme .....	113	Osteotom, LAMBOTTE .....	261
Nasennmesser, CONVERSE .....	435	NORDFOLK/NORWICH, Wundspreizer .....	172	Osteotom, OBWEGESER .....	463, 464/1
Nasennmesser, COTTLE .....	435	NORTHBENT, Fadenschere .....	66	Osteotom, SMITH-PETERSEN .....	261
Nasenolive, POLITZER .....	406	NOTO, Uterus-Polypenzange .....	585	Osteotome .....	259, 464
Nasenpinzette, JANSEN .....	424	NOVAK, Biopsiekürlette .....	587	Osteotome, EPKER .....	464/2
Nasenpinzette, JANSEN-GRUENWALD .....	424	NOVOTEX, Hohlimeißel .....	264	Osteotome, HIBBS .....	265
Nasenpinzette, TROELTSCH .....	424	NOYES, Augenschere .....	75	Osteotome, LEXER .....	263
Nasenraspel, AUFRICHT .....	443	NOYES, Polypenzange .....	425	Osteotome, COTTLE .....	440
Nasenraspel, MILLER .....	444	Nystagmusbrille, FRENZEL .....	20	Osteotome, HOKE .....	265
Nasenraspel, PEET .....	446			Osteotome, STILLE .....	260
Nasenraspel, FOMON .....	444	<b>O</b>		Osteotomklinge .....	266
Nasenraspel, JOSEPH .....	443	Obduktions-Besteck .....	269	OSTROEM, Knochenstanze .....	430
Nasenraspel, JOSEPH (LEWIS) .....	443	Oberarmmanschette .....	295	O'SULLIVAN-O'CONNOR, Bauchdeckenhalter .....	181
Nasenraspel, LEWIS .....	443	Oberschenkelmanschette .....	295	O'SULLIVAN-O'CONNOR, Scheidenspekula .....	576
Nasenraspel, MALTZ .....	443	OBWEGESER, Ahle .....	463, 463/3	OTIS, Urethrotom .....	553
Nasenraspel, MALTZ (COTTLE) .....	444	OBWEGESER, Blattosteotom .....	464/1	Otoskop Diagnostik-Besteck, UNI I .....	13
Nasenraspel, WIENER .....	443	OBWEGESER, Osteotom .....	463, 464/1	OVERHOLT, Arterienklemme .....	114
Nasensäge, JOSEPH .....	446	OBWEGESER, Raspator .....	462	OVERHOLT-BABY, Arterienklemme .....	114
Nasenschere .....	429	OBWEGESER, Wundhaken .....	460, 461	OVERHOLT-GEISENDOERFER, Arterienklemme .....	114
Nasenschere, COTTLE .....	59	OCHSNER, Trokar .....	205	OVERHOLT-MIXTER, Arterienklemme .....	115
Nasenschere, FOMON .....	58	O'CONNOR, Iriskäpfchen .....	375		
Nasenschere, HEYMANN .....	58	OEHLER, chirurgische Pinzette .....	81/1	<b>P</b>	
Nasenspekula, COTTLE .....	423	Ohrhebel, ZAUFAL .....	409	Parametrium-Schere .....	63
Nasenspekula, HARTMANN .....	422	Ohrhebel, ZAUFAL-JANSEN .....	409	Parazentese-Nadel, LUCAE .....	408
Nasenspekula, HARTMANN-HALLE .....	421	Ohrkatheter, HARTMANN .....	408	Parazentese-Nadel, POLITZER .....	408
Nasenspekula, KILLIAN .....	423	Ohrkürette, BUCK .....	407	PARK, Lidsperrer .....	371
Nasenspekula, MOD.VIENNA .....	421	Ohrlöffel, GROSS .....	409	PARKER, Wundhaken .....	139
Nasenspekula, REDA .....	423	Ohrmesser, POLITZER .....	408	PARKER-LANGENBECK, Wundhaken .....	141
Nasenspekula, THUDICHUM .....	421	Ohrmesser, SEXTON .....	408	PARTSCH, Flachmeißel .....	259
Nasenspekula, TIECK-HALLE .....	423	Ohrpinzette JANSEN .....	424	PARTSCH, Hammer .....	271
Nasenspekula, VOLTOLINI .....	421	Ohrpinzette JANSEN-GRUENWALD .....	424	PARTSCH, Hohlimeißel .....	259
Nasentamponzange, LUBET-BARBON .....	424	Ohrpinzette TROELTSCH .....	424	PASSOW, Blutstillungsmeißel .....	260
Nasentamponzange, WESTMACOTT .....	424	Ohrpinzette, LUCAE .....	410	PATELLA, Knochenhaltezange .....	248
Nasenzange, CAPLAN .....	428	Ohrpinzette, TROELTSCH .....	410	PATON, Hornhautdissektor .....	373
Nasenzange, HARTMANN .....	427	Ohrpinzette, WILDE (TROELTSCH) .....	410	PAUFIQUE, Fadenpinzette .....	392
Nasenzange, MYLES .....	427	Ohrschlinge, BILLEAU .....	409	PAUFIQUE, Keratoplastik-Messer .....	373
Nasenzange, SCHMEDEN .....	427	Ohrschlinge, LANGENBECK .....	409	PAYR, Darmquetschklemme .....	548
Nasenzange, TAKAHASHI .....	427	Ohrschlinge, SHAPLEIGH .....	410	PAYR, Führungshohlsonde .....	221
Nasenzange, WATSON-WILLIAMS .....	428	Ohrsonde, STACKE .....	199	PAYR-BABY, Darmquetschklemme .....	548, 548
Nasenzange, WEIL-BLAKESLEY .....	426	Ohrspekula, RICHNAU-HOLMGREN .....	400	PEAN, Arterienklemme .....	108, 110
Nasenzange, STRUYCKEN .....	427	Ohrspekula, BOUCHERON .....	399	PECK-JOSEPH Präparierschere .....	74
NEFF, Meniskusmesser .....	292	Ohrspekula, BRUENINGS .....	401	PEDERSON, Scheidenspekula .....	570
NEGUS, Bruststütze .....	459	Ohrspekula, GRUBER .....	399	PENFIELD, Dissektor .....	333
NEGUS, Tonsillenzange .....	467	Ohrspekula, HARTMANN .....	399	PEERS, Tuckklemme .....	132
NEIVERT, Nadelhalter .....	208	Ohrspekula, POLITZER .....	399	PEET, Nasenraspel .....	446
NEIVERT-ANDERSON, Septummeißel .....	442	Ohrspekula, SIEGLE .....	402	PEET, Splitterzange .....	92
NELATON, Hohlsonde .....	199	Ohrspekula, TOYNBEE .....	399	PELKMANN, Tupperzange .....	137
NELSON, Gefäßpinzette .....	89	Ohrspekulahalter, LEYLA .....	368/3	Pelvis-Haken, St. MARKS .....	165
NELSON, Trokar .....	205	Ohrspitze, REINER .....	406	Penisklemme, STOCKMANN .....	553/1
NELSON, Unterbindungsnaedel .....	219	Ohrzängchen, HARTMANN .....	411	Penisklemme, STRAUSS .....	553/1
NEONATAL, Atraumaklemme .....	523	Ohrzängchen, LITTAUER .....	411	PENNINGTON, Arterienklemme .....	109
Neonatal-Gefäßklemme, CASTANEDA .....	527	Ohrzängchen, TILLEY .....	411	PENNINGTON, Septumellevator .....	438
Nervenhaken, CUSHING .....	328	OLDBERG, Laminektomie-Zange .....	341	PERCY, Retraktor .....	296
Nervhäkchen, KRAYENBUEHL .....	336	OLIVECRONA, Drahtsäge .....	332	Perforatorie, SMELLIE .....	607
Nervhaken, CRILE .....	328	OLIVECRONA, Dura-Dissektor .....	332	Peripherale-Gefäßklemme, DeBAKEY .....	494
Nervhaken, DANDY .....	328	OLIVECRONA, Hirmspatel .....	336	Peripherale-Gefäßklemme, LELAND-JONES .....	494
Nervhaken, GRAHAM .....	329	OLIVECRONA, Hohlimeißelzange .....	237	Peritoneumklemme, FAURE .....	123
Nervhaken, SACHS .....	329	OLIVECRONA-TOENNIS, Anlegezange .....	326	Peritoneumklemme, MIKULICZ .....	123
Nervhaken, SMITHWICK .....	329	OLLIER, Wundhaken .....	162	Peritoneumklemme, PHANEUF .....	123
Nervrädchen, WARTENBERG .....	25	OLSEN-HEGAR, Nadelhalter .....	212	PERKINS, Wundspreizer .....	168
Nerwurzelhaken, D'ERRICO .....	329/2	OMBREDANNE, Hammer .....	273	Perkussionshammer, BABINSKY .....	24
Nerwurzelhaken, HESS .....	329/1	Opthalmologie-Schere, GRADLE .....	57	Perkussionshammer, BERLINER .....	24
Nerwurzelhaken, LOVE .....	329/2, 330	Opthalmologie-Schere, AEBLI .....	58	Perkussionshammer, BUCK .....	24
Nerwurzelhaken, SCOVILLE .....	329/1, 330	Opthalmologie-Schere, STEVENS .....	58	Perkussionshammer, TAYLOR .....	24



Perkussionshammer, TROEMNER .....	24	Präparierschere, TOENNIS-ADSON.....	65	Raspator, OBWEGESER.....	462
PERTHES, Pfiem .....	304	Präparierschere, METZENBAUM FINO TC .....	53/1	Raspator, QUERVAIN .....	275
PESTALOZZA, Abortuskürette .....	606	Präparierschere, PECK-JOSEPH .....	74	Raspator, SEBILEAU .....	275
PETRI, Box .....	620	Präparierschere, MAYO-NOBLE.....	52	Raspator, SEDILLOT .....	274, 275
PETZ, Magen- und Darmtraktapparat .....	549	PRATT, Dilatator .....	580	Raspator, SELDIN.....	277
Pfiem .....	304	PRATT, Faßzange .....	110	Raspator, SEMB .....	278
Pfiem, PERTHES.....	304	PRATT, Fistelsonde .....	563	Raspator, WILLIGER.....	276
Phalagenmesser .....	44	PRATT, Hakenzange .....	584	Raspatorium, MOLT .....	276
PHANEUF, Peritoneumklemme .....	123	PRATT, Mastdarm-Spekula .....	559	Rauchabsaugrohr, KLEINSASSER .....	36
PIERCE, Kieferhöhlentroktr .....	204	PRATT, Uterus-Dilatator .....	580	RECAMIER, Uteruskürette .....	597, 598
PIERCE, Septumellevator .....	438	PRECISA, Blutdruckmeßgerät .....	9	Recordspritze .....	596
PIFFARD, Lupuskürette .....	608	PRESBYTERIAN, Schlauchklemme .....	129	REDA, Amputationsmesser .....	44
PILLING, Clipanlegezange .....	524, 525	PRICE-THOMAS, Bronchusklemme .....	490	REDA, Augenmagnet .....	395
PINARD, Stethoskop .....	23	PRINCE, Muskelpinzette .....	387	REDA, Cilienpinzette .....	395
Pinzette, anatomisch .....	81	PRINCE, Tonsillenschere .....	59	REDA EXCENTER, Verbandschere .....	69/2
Pinzette, bipolar .....	630 - 632	PROBE AND PACKER .....	612	REDA, Fadengabel .....	221
Pinzette, BONNEY.....	88	Profundaklemme, GREGORY .....	517	REDA, Fingerringssäge .....	297
Pinzette, DeBAKEY .....	98	Proktoskop, BENSAUDE .....	565	REDA, Gipsspreizer .....	232
Pinzette, JACKSON.....	471	Proktoskop, MORGAN .....	565	REDA, Handbohrapparat .....	300
Pinzette, MAYO .....	89	Proktoskop, CHELSEA-EATON .....	563	REDA, Hauthäkchen.....	150
Pinzette, STRASSBURGER MODELL .....	89	Proktoskop, FANSLER .....	564	REDA, Kappenzange .....	615
Pinzette, Uhrmacher.....	90	Proktoskop, HIRSCHMANN .....	563	REDA, Klingenbrecher .....	45
Pinzette, ULTRA-LIGHT.....	95	Proktoskop, IVES-FANSLER .....	563	REDA, Knochenhaltezange .....	246, 247
Pinzette, WAGENSTEEN .....	89	Proktoskop, KELLY .....	563, 564	REDA, Mikro-Rohrschaftzange .....	474
Pinzette, DAVIS .....	227	Prostatafaßzange, MILLIN .....	550, 551	REDA, Nasenspekulum .....	423
Pinzette, GOMEL .....	96	Prostatahaken, YOUNG .....	550	REDA, Organ- u. Gewebefaßzange, atrauma .....	111
Pinzette, YASARGIL .....	97	PROVIDENCE-HOSPITAL, Arterienklemme .....	106	REDA, scharfer Löffel .....	256
PIPER, Geburtszange .....	604	Pulverbläser, KABIBERSKE .....	405	REDA, Sichelmesser .....	435
Pistole f. Reinigung .....	626	Pulverbläser, UNIVERSAL .....	405	REDA, Watteträger .....	203
Plastik-Hammer .....	271	Pumpe f. Komprimeter .....	295	REDON, Führungsadel .....	207
Plazentabecken .....	621	Punktionskanüle, FRAZIER .....	337	REES, Face-Lift-Schere .....	73
PLESTER, Messer .....	418	Punktionskanüle, LICHTWITZ .....	433	Reibzähle .....	304
PLESTER, Saugrohr .....	338	PUTTI, Knochenraspel .....	294	REICHERT, Kehdeckelhalter .....	471
PLESTER, Wundspreizer .....	171	Pyloruspreizer, BENSON .....	544	REILL, Knochenhaltezange .....	248
POLITZER, Gummibirne .....	406	Q		REINER, Gipsmesser.....	233
POLITZER, Luftdusche .....	406	QUERVAIN, Elevator .....	275	REINER, Ohrspritze .....	406
POLITZER, Nasenolive .....	406	QUINBY, Zahnfleischschere .....	67	Reinigungsaufsatz .....	626
POLITZER, Ohrmesser .....	408	QUIRE, Fremdkörperhebel .....	412	Reinigungspistole .....	626
POLITZER, Ohrspekula .....	399	QUISLING, Hammer .....	271	Rektal-Absaugrohr, BUJE .....	566
POLITZER, Parazentese-Nadel .....	408	R		Rektal-Schnürer, WESTON.....	566
Polster f. Oberarm- u. Oberschenkelmanschette .....	295	Rachiotom .....	267	Rektal-Spekulum, SAWYER .....	560
Polypenschlinge .....	411	RADOLF, Nagelauseißzange .....	297	Rektal-Spekulum, HILL-FERGUSON .....	560
Polypenschnürer, KRAUSE-VOSS .....	433/2	Rahmen f. DENIS-BROWNE, Bauchdeckenhalter .....	185	Rektum-Anastosenklemme, HAYES .....	545
Polypenschnürer, KRAUSE .....	411, 433/2	Rahmen f. KIRSCHNER, Bauchdeckenhalter 185, 187, 187/1 .....	187, 187/1	Repositionszange, ROWE .....	459
Polypenschnürer, WILDE .....	411, 433/2	Rahmen f. O'SULLIVAN-O'CONNOR.....	576	RESANO, Darmklemme .....	542
Polypenzange, HEYMANN-KNIGHT .....	425	RALK, Handbohrapparat .....	300	RESANO, Kapselschere .....	53/2
Polypenzange, HARTMANN .....	424	RAMPLEY, Tupferzange .....	136	Resektionsmesser .....	47
Polypenzange, LITTAUER.....	425	RAMUS, Wundhaken.....	461	Retraktor, PERCY .....	296
Polypenzange, NOYES.....	425	RANDALL, Biopsiekürette .....	587	Retraktoren, Intraoral .....	463/1, 463/4
POOLE, Saugrohr .....	27	RANDALL, Nierensteinzange .....	535	Retraktor-System, LEVLA .....	368 - 368/4
POST MORTEM .....	269	RANEY, Klammeranlagezange .....	327	REVERDIN, Darmspatel .....	143/1
POTTS, Gefäßsklemme .....	492, 493	RANEY, Kopfhautklammern .....	327	REVERDIN, Nadel .....	220
POTTS, Anastomosen-Klemme .....	493	RANGELL, Wundhaken .....	140	REYNOLDS, chirurgische Schere .....	54
POTTS, Coarctations-Klemme .....	492	Rasierklingen .....	45	REYNOLDS, Supercuttschere .....	72
POTTS-SMITH, chirurgische Pinzette .....	81	Rasiermesser .....	49	Rhinoplastikschere, FOMON .....	65/1
POTTS-DE MARTEL, Gefäßschere .....	59	Raspator .....	279	RIBBON, Darmspatel .....	143
POTTS-SMITH, anatomische Pinzette .....	81	Raspator, ADSON.....	282	RICARD, Bauchdeckenhalter .....	191
POTTS-SMITH, Gefäßschere .....	61	Raspator, ALEXANDER .....	276	RICHARDSON, Wundhaken .....	142
Präparierschere .....	52	Raspator, COBB .....	280	RICHARDSON-EASTMAN, Wundhaken .....	142
Präparierschere, DEAYER .....	52	Raspator, DINGMANN .....	463, 463/3	RICHARDSON-GRIP, Wundhaken .....	142
Präparierschere, MAYO .....	52	Raspator, DOYEN .....	278	RICHNAU-HOLMGREN, Ohrspekula .....	400
Präparierschere, MAYO TC .....	52	Raspator, FARABEUF .....	274	RICHTER-HEATH, Wundklammerzange .....	224
Präparierschere, METZENBAUM .....	53/1	Raspator, FARABEUF-COLLIN .....	274	RIENHOFF-FINOCHIETTO, Rippensperrer .....	486
Präparierschere, WELLER .....	53/2	Raspator, FOMON .....	277	RIGBY, Bauchdeckenhalter .....	189/2
Präparierschere, JORGENSEN.....	53	Raspator, HARGIS .....	463/2	Ri-MINI, Diagnostik-Besteck .....	17
Präparierschere, LEXER .....	53	Raspator, JOSEPH .....	277	RING, Zungenspatel .....	455
Präparierschere, LEXER-BABY .....	53	Raspator, KOENIG .....	276	Ringmesser, BECKMANN .....	450
Präparierschere, LEXER-BABY TC .....	53	Raspator, LAMBOTTE .....	274	Ringmesser, BARNHILL .....	450
Präparierschere, METZENBAUM .....	53/1	Raspator, LANGENBECK .....	275	Ringmesser, LA FORCE .....	450
Präparierschere, METZENBAUM FINO .....	53/1	Raspator, MATSON .....	279	Ringmesser, St. CLAIR-THOMSON .....	450
Präparierschere, METZENBAUM TC .....	53/1	Raspator, MATSON-ALEXANDER .....	279	Rippenkontraktor, BAILEY .....	489
				Rippenkontraktor, BAILEY-BABY .....	489
				Rippenkontraktor, BAILEY-GIBBON .....	489



Rippenschere, SAUERBRUCH-FREY .....	481	SAUERBRUCH, Abfallzange .....	227	Scheidenspekula, SCHERBAK .....	575
Rippenschere, BETHUNE .....	481	SAUERBRUCH, Hohlmeißelzange .....	240	SCHIEE, Goniotomiemesser .....	373
Rippenschere, BRUNNER .....	481	SAUERBRUCH, Rippenschere .....	481	SCHNEIMANN, Aufsatz .....	472
Rippenschere, CORYLLOS .....	480	SAUERBRUCH, Wundhaken .....	164, 166	SCHERBAK, Scheidenspekula .....	575
Rippenschere, GIERTZ-STILLE .....	481	SAUERBRUCH-FREY, Rippenschere .....	481	Schere, GORNEY .....	73
Rippenschere, GLUCK .....	480	Sauggriff, WULLSTEIN .....	338	Schere, MIKRO .....	76
Rippenschere, SAUERBRUCH .....	481	Saugraspatorium, GUILLEN .....	433/1	Schere, Neurochirurgie .....	65
Rippenschere, STILLE .....	480	Saugrohr .....	337/1	Schere, PARAMETRIUM .....	63
Rippensperrerr, COOLEY .....	485, 487	Saugrohr, FERGUSSON .....	337	Schere, REES .....	73
Rippensperrerr, COOLEY-NEONATAL .....	485	Saugrohr, ZÖLLNER .....	337/1	Schere, WAGNER .....	67
Rippensperrerr, DE BOER .....	486	Saugrohr, ADSON .....	337	Schere, CASTROVIEJO .....	79
Rippensperrerr, FINOCHIETTO .....	482, 484	Saugrohr, ANDREW-PYNCHON .....	28	Schere, DOYEN .....	63
Rippensperrerr, FINOCHIETTO-BABY .....	482	Saugrohr, BABY-YANKAUER .....	27	Schere, HEPP-SCHIEDEL .....	78
Rippensperrerr, FINOCHIETTO-BURFORD .....	483	Saugrohr, BARON .....	336	Schere, SIEBOLD .....	62
Rippensperrerr, HAIGHT .....	487	Saugrohr, COOLEY .....	28	Schere, SIMS .....	62
Rippensperrerr, MORSE .....	484	Saugrohr, DeBAKEY .....	28	Schere, THOREK .....	65/2
Rippensperrerr, MORSE-FAVALORO .....	484	Saugrohr, FRAZIER/FERGUSSON .....	337	Schieblehre, TOWNLEY .....	26
Rippensperrerr, RIENHOFF-FINOCHIETTO .....	486	Saugrohr, PLESTER .....	338	Schielhaken, GRAEFE .....	375
Rippensperrerr, TUFFIER .....	487	Saugrohr, POOLE .....	27	Schielhaken, JAMESON .....	375
RITTER-HALLE, Stirnhöhledilatator .....	433	Saugrohr, ROSEN .....	338	Schildrüsenhaken, SCHOENBORN .....	479
ROBB, Gefäßdissektor .....	530	Saugrohr, YANKAUER .....	27	SCHIMMELBUSCH, Verbandstoffrommel .....	622
ROBB, Spatel .....	530	Saugrohr, YASARGIL .....	337/1	SCHINK, Dermatome .....	49
ROBERTS, Arterienklemme .....	117	Saugrohre, HOUSE .....	337/2	SCHIOETZ, Tonometer .....	394/2
ROCHARD, Bauchdeckenhalter .....	186	SAWTELL, Tonsillenzange .....	467	Schlauchhalterung .....	188
ROCHARD, Fixiervorrichtung .....	186	SAWYER, Rektal-Spekulum .....	560	Schlauchklemme, KLINIKUM BERLIN .....	129
ROCHESTER-CARMALT, Arterienklemme .....	109	SAYRE, Elevator .....	281	Schlauchklemme, PRESBYTERIAN .....	129
ROCHESTER-OCHSNER, Arterienklemme .....	108	SCAGLIETTI, Hohlmeißelzange .....	240	Schlauchklemme, HOFFMANN .....	624
ROCHESTER-PEAN, Arterienklemme .....	108	SCALP-CONTOUR, Wundspreizer .....	169	Schlauchklemme, SIMPLEX .....	624
ROEDER, Tuchklemme .....	132	Schädelhalter, CRUTCHFIELD .....	327	Schlauchklemme, BÜLOW-GUNAR-HEY .....	130
ROGER, Septumlevator .....	437	Schädelspalter .....	267	Schlauchklemmen .....	129
ROGERS, Hysterektomieklammer .....	127	Schädelstanze, CONE .....	331	Schlauchverbindungsstück .....	600
ROGGE, Sterilisierzange .....	227	SCHAEDEL, Tuchklemme .....	132	SCHLESINGER, Laminektomiezange .....	342
ROLLET, Exstirpationsmeißel .....	374	Schädelzange, DeVILBISS .....	332	Schließklemme, STONE .....	545
ROLLET, Tränensackhäkchen .....	375	Schaft .....	231/3	Schlinge f. Polypenschnürer .....	433/2
ROSE, Wundhaken .....	140	Schale .....	619	Schlüssel f. Meißel .....	266
ROSEN, Messer .....	418	Schälmesser, Tracheotomie .....	475	Schlüssel f. Osteotome .....	266
ROSEN, Nadel .....	419	SCHAMBERG, Komedonenquetscher .....	608	Schlüsselpaar f. Gipssäge und Autopsiesäge .....	230, 231/3
ROSEN, Saugrohr .....	338	Scharfer Löffel .....	255	SCHMEDEN, Nasenzange .....	427
ROSER-KOENIG, Mundsperrerr .....	454	Scharfer Löffel, BRUNS .....	251, 254	SCHMID, Gefäß- u. Spülkanüle .....	338
ROUX MINI, Wundhaken .....	140	Scharfer Löffel, BUSHE .....	256	SCHMIEDEN, Führungshohlsonde .....	221
ROUX, Wundhaken .....	139	Scharfer Löffel, COBB .....	252	SCHMIEDEN-DICK, Unterbindungsnadel .....	219
ROUX-BABY, Wundhaken .....	140	Scharfer Löffel, DAUBENSPECK .....	255	SCHMIEDEN-TAYLOR, Duraschere .....	65/1
ROWE, Repositionszange .....	459	Scharfer Löffel, HALLE .....	253	Schnellkupplungs-T-Handgriff .....	300, 301
RUBIN, Septummeißel .....	440	Scharfer Löffel, JACOBSON .....	257	Schnellkupplungs-Handgriff .....	301
RUBIN, Septumzange .....	428	Scharfer Löffel, JANSEN .....	257	SCHNIDT, Tonsillenzange .....	467
RUDD, Hämorrhoidal-Ligatur .....	568	Scharfer Löffel, LEMPERT .....	256	SCHOENBORN, Schilddrüsenhaken .....	479
RUMEL, Arterienklemme .....	117	Scharfer Löffel, MARTINI .....	257	Schraubenhaltehülse .....	324
RUMEL-BELMONT, Tourniquet .....	528	Scharfer Löffel, REDA .....	256	Schraubenhaltezange, LANE .....	325
RUSKIN, Hohlmeißelzange .....	239	Scharfer Löffel, SCHEDE .....	251	Schraubenzieher m. Ferrozellgriff .....	323
RUSKIN-LISTON, Knochensplitterzange .....	241	Scharfer Löffel, SCOVILLE .....	253	Schraubenzieher, WILLIAMS .....	323
RUSSEL-DAVIS, Zungenspatel .....	458	Scharfer Löffel, SPINAL .....	253	Schraubenzieher, LANE .....	323
RUSSISCHES MODELL, Fußpinzette .....	85	Scharfer Löffel, SPRATT .....	251	Schröder, Hakenzange .....	584
RYDEL-SEIFFERT, Stimmgabel .....	404	Scharfer Löffel, VOLKMANN .....	257	SCHRÖDER, Uteruslöffel .....	595
RYDER, Nadelhalter .....	210	Scharfer Löffel, WILLIGER .....	255, 257	SCHROEDER (POZZI), Hakenzange .....	582
S		SCHUDE, scharfer Löffel .....	251	SCHROEDER, Hakenzange .....	583
SAALFELD, Komedonenquetscher .....	608	Scheidenspekula .....	569 - 577	SCHUBERT, Biopsiezange .....	588
SACHS, Dura-Dissektor .....	332	Scheidenspekula, JACKSON .....	573	SCHUKNECHT, Messer .....	418
SACHS, Nervhaken .....	329	Scheidenspekula, AUVARD .....	576	SCHULTZE, Salpingograph .....	596
SAENGER, Abortuszange .....	606	Scheidenspekula, BREISKY .....	577	SCHULZE-BERGMANN, Mastdarm-Spekula .....	560
Säge, GIJLI .....	332	Scheidenspekula, COLLIN .....	570	SCHUMACHER, Aufsatz .....	472
Sägeblatt f. Fingerringssäge .....	297	Scheidenspekula, CUSCO .....	570, 571	SCHUMACHER, Biopsiezange .....	588
Sägeblätter .....	230	Scheidenspekula, DELEE .....	574	SCHUMACHER, Episotomieschere .....	64
Sagittalspreizer, SMITH .....	463/5	Scheidenspekula, DOYEN .....	574	SCHUMACHER, Sternumschere .....	481
Salpingograph, SCHULTZE .....	596	Scheidenspekula, GRAVE .....	570	SCHUMACHER, Uterus-Biopsiezange .....	589
SANVENERO, chirurgische Schere .....	54	Scheidenspekula, KALLMORGEN .....	573	Schüssel .....	619
SAROT, Arterienklemme .....	118	Scheidenspekula, KRISTELLER .....	572	SCHWEIGGER, Kapselpinzette .....	391
SAROT, Nadelhalter .....	211	Scheidenspekula, LANDAU .....	577	Schwingmesser, BALLENGER .....	436
SATINSKY, Gefäßklemme .....	491	Scheidenspekula, O'SULLIVAN-O'CONNOR .....	576	SCOVILLE, Haken .....	196
SATINSKY, Gefäßschere .....	65/2	Scheidenspekula, PEDERSON .....	570	SCOVILLE, Laminektomiespreizer .....	196
SATINSKY, Tangentialklemme .....	502	Scheidenspekula, SEMM .....	571	SCOVILLE, Nervwurzelhaken .....	329/1, 330
SATO, Hornhautmesser .....	373	Scheidenspekula, SIMS .....	573	SCOVILLE, scharfer Löffel .....	253
SATTERLEE, Amputationssäge .....	296	Scheidenspekula, TRELAT .....	571	SCOVILLE-HAVERFIELD, Laminektomiespreizer .....	196
		Scheidenspekula, VU-MORE .....	569	SCUDDER, Darmklemme .....	541



SEBILEAU, Raspator.....	275	SHAMBAUGH, Häkchen.....	419	Sonde, HARMS.....	381
SEDLLOT, Raspator.....	274, 275	SHAPLEIGH, Ohrschlinge.....	410	Sonde, MARTIN.....	586
Segmentsäge.....	231/2	SHEA, Mikro-Ohrschere.....	413	Sonde, SIMS.....	586
SEGOND, Hysterektomieklamme.....	125	SHEEHAN, Osteotom.....	441	Sonde, WATSON-CHEYNE.....	199
SEGOND, Myommesser.....	594	SHEEHAN, Septummeißel.....	441	Sonde, WORST.....	381
SEGOND-LANDAU, Hysterektomieklamme.....	125	SHEETS, Augenkanüle.....	394/2	Sonden.....	199
Sehnenfaßinstrument, BRAND.....	293	Sichelmesser, REDA.....	435	Sondenspitzen f. NABATOFF.....	201
Sehnenfaßinstrument, CAROLL.....	293	Sichelmesser, Tracheotomie.....	475	Spannarm, flexibel, LEYLA.....	368/3
Sehnenfaßinstrument, KLEINERT-KUTZ.....	294	SIEBENMANN, Spülkanüle.....	433/1	Spannplatte.....	49
Sehnenfaßpinzette, LARSEN.....	292	Siebkorb für Endoskope u. Lichtleiterkabel.....	623	Spannschlüssel.....	313
Sehnenfaßzange.....	293	Siebkorbdeckel.....	623	Spatel.....	203, 612/1
Sehnenfaßzange, JACKSON.....	292	SIEBOLD, gynäkologische Schere.....	62	Spatel, ROBB.....	530
Sehnenführer, BUNELL.....	294	Siebschale, perforiertes Blech.....	623	SPATULA AND PACKER.....	612
Sehnenhaltezange, STEINMANN.....	292	SIEGLE, Ohrspekula.....	402	Spekula, FRIEDMANN.....	577
Sehenschäler, BRAND.....	294	Silberklammern.....	326	Spekula, KALLMORGEN.....	573
Sehenschäler, BUNNELL.....	292	Silikoneinlage f. DAVIS-BOYLE.....	455	Spekula, KRISTELLER.....	572
SEIFERT, Aufsatz.....	472	Silikonmatte.....	616	SPENCER, Fadenschere.....	66
Sektionsnadel.....	268	Silikonschlauch f. McIVOR.....	457	SPENCER-WELLS, Arterienklamme.....	109
SELDIN, Raspator.....	277	SILVER, Dermatome.....	50	Sperrer, DAVIS-BOYLE.....	455
SELECT, Verbindungskabel.....	633	SILVER, Septummeißel.....	442	Sperrer, DINGMANN.....	456
SELLHEIM, Geburtsöffel.....	607	SIMCOE, Spülkanüle.....	394/2	Sperrer, KILNER-DOUGHTY.....	456
SEMB, Bronchusklamme.....	491	SIMON, Uteruslöffel.....	594	Spinalhaken, TAYLOR.....	291
SEMB, Hohlmeißelzange.....	240	SIMON, Wundhaken.....	164	SPINAL, scharfer Löffel.....	253
SEMB, Knochenhaltezange.....	243	SIMPLEX, Schlauchklamme.....	624	SPINA-NASALIS, Wundhaken.....	461
SEMB, Knochen splitterzange.....	242	SIMPSON, Geburtszange.....	602	Spiralbohrer.....	302
SEMB, Raspator.....	278	SIMPSON-BRAUN, Geburtszange.....	602	Spitze f. YANKAUER Saugrohr.....	27
SEMKEN, anatomische Pinzette.....	86	SIMPSON-LUIKART, Geburtszange.....	603	Splitterpinzette.....	91
SEMKEN, chirurgische Pinzette.....	86	SIMS, gynäkologische Schere.....	62	Splitterpinzette, CARMALT.....	91
SEMM, Scheidenspekula.....	571	SIMS, Mastdarm-Spekula.....	559	Splitterpinzette, FEILCHENFELD.....	91
SENN-GREEN, Wundhaken.....	153	SIMS, Scheidenspekula.....	573	Splitterpinzette, HUNTER.....	91
SENN-MILLER, Wundhaken.....	143	SIMS, Sonde.....	586	Splitterzange, ARCHER.....	92
Septemzange, KNIGHT.....	425	SIMS, Uterus-Dilatator.....	581	Splitterzange, PEET.....	92
Septemzange, HEYMANN.....	425	SIMS, Uterus-Depressor.....	586	Splitterzange, VIRTUS (RALK).....	92
Septumhohlmeißel, FREER.....	442/1	SIMS, Uteruskürette.....	597, 598	Splitterzange, STIEGLITZ.....	92
Septumhohlmeißel, HAJEK.....	442/1	SIMS, Uterussonde.....	586	SPRATT, scharfer Löffel.....	251
Septumhohlmeißel, KILLIAN-CLAUS.....	442/1	SIMS-MAIER, Kornzange.....	134	Spreizer, SMITH.....	463/5
Septummosteotom, SHEEHAN.....	441	SINGLEY, Gewebefäßpinzette.....	88	Spritzen.....	407
Septummosteotome, CINELLI.....	441	SINOSKOPIE-TROKAR.....	205	Spül- u. Saugkanüle, BISHOP-HARMON.....	394/1
Septummosteotome, FOMON.....	441	SINSKEY, Häkchen.....	376	Spülkanüle, KILLIAN.....	433, 433/1
Septumelevator, FREER.....	437, 439	SINUS, Septumelevator.....	438	Spülkanüle, EICKEN (KILLIAN).....	433
Septumelevator, HOWARTH.....	438	Sinuskopie-Zange.....	431	Spülkanüle, HARTMANN.....	433
Septumelevator, McKENTY.....	437, 438	Skalpelle Mini.....	41	Spülkanüle, SIEBENMANN.....	433/1
Septumelevator, BALLENGER.....	439	Skalpelle mit Metallheft.....	46	Spülkanüle, SIMCOE.....	394/2
Septumelevator, COTTLE.....	439	Skalpelle, steril.....	43	SPURLING, Laminektomiezange.....	340
Septumelevator, COTTLE-JOSEPH.....	439	Skalpelloffener.....	38 - 42	Sputumbecher.....	621
Septumelevator, HAJEK-BALLENGER.....	439	Skalpelloffener Mini.....	41	St. CLAIR-THOMSON, Ringmesser.....	450
Septumelevator, HALLE.....	437	Skalpelloffener.....	42	St. MARKS-PELVIS, Haken.....	165
Septumelevator, JOSEPH.....	437	Skalpelloffener-Entferner.....	42	St. MARKS, Wundhaken.....	165
Septumelevator, KILLIAN.....	438, 439	SKENE, Hakenzange.....	582	St. MARTIN, Nahtpinzette.....	392
Septumelevator, PENNINGTON.....	438	Sklerotom, GUYTON-LUNDSGAARD.....	373	STACKE, Ohrsonde.....	199
Septumelevator, PIERCE.....	438	Sklerotom, LUNDSGAARD.....	373	STAMM, Knochensplitterzange.....	241
Septumelevator, ROGER.....	437	SLS, Clipanlagezange.....	524, 525	Standard, chirurgische Schere.....	51
Septumelevator, SINUS.....	438	SLUDER-BALLENGER, Tonsillotom.....	470	STANDARD (NELSON), Trokar.....	204
Septummeißel, CINELLI.....	441	SMELLIE, Haken.....	605	Standgefäß.....	620
Septummeißel, COTTLE.....	440	SMELLIE, Perforatorie.....	607	Stanze, COLCLOUGH.....	344/1
Septummeißel, FOMON.....	441	SMILIE, Meniskusmesser.....	292	Stanze, FERRIS-SMITH-KERRISON.....	344
Septummeißel, FREER.....	439	SMILLIE, Knochenhebel.....	291	Stanze, ÖSTROEM.....	430
Septummeißel, NEIVERT-ANDERSON.....	442	SMITH, Lidsperrer.....	370	Stanze, CITELLI.....	430
Septummeißel, RUBIN.....	440	SMITH, Sagittalspreizer.....	463/5	Stanze, HAJEK-KÖFLER.....	429, 431
Septummeißel, SHEEHAN.....	441	SMITH, Spreizer.....	463/5	Stanze, KERRISON.....	428
Septummeißel, SILVER.....	442	SMITH US ARMY, Verbandschere.....	69/1	Stariöffel, DAVIEL.....	377
Septumrichtzange, ASCH.....	449	SMITH-BUIE, Analspreizer.....	561	Stariöffel, GRAEFE.....	377
Septumrichtzange, WALSHAM.....	449	SMITH-PETERSEN, Hohlmeißel.....	261	Stariöffel, KNAPP.....	378
Septumschere, KILLIAN.....	471	SMITH-PETERSEN, Hohlmeißelzange.....	238	Starmesser, DEUTSCHMANN.....	371
Septumzange, BRUENINGS.....	425	SMITH-PETERSEN, Osteotom.....	261	Starmesser, GRAEFE.....	371
Septumzange, GRAIG.....	426	SMITHWICK, Anlegezange.....	326	starrer Haltearm, LEYLA.....	368/1
Septumzange, LUC.....	426	SMITHWICK, Nervhaken.....	329	Starschlinge, ARLT.....	378
Septumzange, MIDDLETON-JANSEN.....	430	SNELLEN, Muskelpinzette.....	393	Starschlinge, SNELLEN.....	378
Septumzange, RUBIN.....	428	SNELLEN, Starschlinge.....	378	Starschlinge, WEBER.....	378
SERPENTINE-GRASPER, Faßzange, flexibel.....	593	SOMER, Uterus-Faßzange.....	585	Starschlinge, WILDER.....	378
SEUTIN, Verbandschere.....	69/2	Sonde VALLEIX.....	586	Stativ.....	188
SEXTON, Ohnmesser.....	408	Sonde, COLLIN.....	586	Staubinde, ESMARCH.....	296
Seziermesser, VIRCHOW.....	48	Sonde, FISH.....	199	STAUDE-MOORE, Hakenzange.....	582



Stechbecken.....	621	Supercutschere, FREEMAN .....	74	Titan-Arterienklemme, KELLY .....	106
STEINMANN, Endernagel .....	307, 308	Supercutschere, GORNEY .....	73	Titan-Pinzette, DeBAKEY, atrauma .....	99
STEINMANN, Knochenagel.....	307, 308	Supercutschere, IRIS .....	72	Titan-Buldgoklemme, atrauma .....	102
STEINMANN, Sehenhaltezange .....	292	Supercutschere, KAYE .....	73	TOBOLD, Watteträger .....	203
STELLBRINK, Hohlmeißelzange .....	234	Supercutschere, KILNER .....	72	TOBOLD, Zungendrucker .....	453
sterile Ersatzlinge .....	50	Supercutschere, LISTER .....	72	TOENNIS, Arterienklemme .....	117
sterile Skalpelle .....	43	Supercutschere, MAYO .....	71	TOENNIS, Dura-Dissektor .....	332
sterile Skalpelli-Klingen .....	42	Supercutschere, MAYO-STILLE .....	71	TOENNIS-ADSON, Schere .....	65
Sterilisierbehälter .....	616	Supercutschere, METZENBAUM .....	71	TOHUUKU, Tuchklemme .....	132
Sterilisierkasten .....	616, 618	Supercutschere, REES .....	73	Tonometer, SCHIOETZ .....	394/2
Sterilisierklammer, BUNT .....	227, 624	Supercutschere, REYNOLDS .....	72	Tonsillennadel, CLAUS .....	466
Sterilisierklammer, MAYO .....	227, 624	Supercutschere, STEVENS .....	72	Tonsillennadel, CLAUS-EICKEN .....	466
Sterilisiersiebschale .....	622	Supercutschere, WAGNER .....	72	Tonsillennadel, DUPUY-WEISS .....	466
Sterilisierzange .....	227	Supercutschere, BABY METZENBAUM .....	71	Tonsillennadel, NAGER .....	466
Sterilisierzange, CHEATLE .....	227	SWEEP, Anlegezange .....	326	Tonsillendissektor, HURD .....	465
Sterilisierzange, ROGGE .....	227	SYSTRUNK, chirurgische Schere .....	66	Tonsillendissektor, LOPEZ-REINKE .....	465
Sterilisierzange, UNIVERSAL .....	227			Tonsillendissektor, YANKAUER .....	465
STERNBERG, Wangenhalter .....	453	T .....		Tonsillendradt .....	468
Sternnummeißel, LEBSCHKE .....	267, 480	TABB, Messer .....	418	Tonsillenelevator, CARPENTER .....	465
Sternumschere, SCHUMACHER .....	481	Tablett .....	620	Tonsillenelevator, HENKE .....	465
Stethoskop, ANESTOPHON .....	23	Tablettenschale .....	621	Tonsillenfußpinzette, MARSCHIK .....	468
Stethoskop, DUPLEX .....	23	TAKAHASHI, Nasenzange .....	427	Tonsillenfußzange, ABRAHAM .....	468
Stethoskop, PINARD .....	23	Tamponstopfer, LUNIATSCHEK .....	465	Tonsillenfzange, COLVER .....	467
STEVENS, Irispinzette .....	383	Tamponzange, BOZEMANN .....	138	Tonsillennmesser, ABRAHAM .....	466
STEVENS, Linsenhaken .....	375	Tamponzange, BOZEMANN-DOUGLAS .....	138	Tonsillennmesser, BRUENINGS .....	466
STEVENS, Nadelhalter .....	214	Tangentialklemme, DeBAKEY .....	502	Tonsillennmesser, CANFIELD .....	466
STEVENS, Ophthalmologie-Schere .....	58	Tangentialklemme, DeBAKEY-SATINSKY .....	502	Tonsillennmesser, CARPENTER .....	465
STEVENS, Supercutschere .....	72	Tangentialklemme, SATINSKY .....	502	Tonsillennmesser, DOUGLAS .....	466
STEVENSON, Lidsperrerr .....	371	TARNIER, Geburtszange .....	604	Tonsillennmesser, FISHER .....	466
STIEGLITZ, Splitterzange .....	92	TARNIER, Kranioclast .....	607	Tonsillennadel .....	470
STILLE, anatomische Pinzette .....	81	Taschenbesteck .....	225, 226	Tonsillenschere .....	59
STILLE, Arterienklemme .....	122	TAYLOR, chirurgische Pinzette .....	87	Tonsillenschere, BOETTCHEER .....	59
STILLE, chirurgische Pinzette .....	81/1	TAYLOR, Haken .....	196	Tonsillenschere, DEAN .....	59
STILLE, Flachmeißel .....	260	TAYLOR, Perkussionshammer .....	24	Tonsillenschere, GOOD .....	59
STILLE, Gipschere .....	229	TAYLOR, Spinalhaken .....	291	Tonsillenschere, PRINCE .....	59
STILLE, Handbohrapparat .....	298	TC chirurgische Schere fein, REYNOLDS .....	54	Tonsillenschnürer, TYDING .....	469
STILLE, Hohlmeißel .....	260	TC chirurgische Schere, STANDARD .....	51	Tonsillenschnürer, BRUENINGS .....	468
STILLE, Osteotom .....	260	TC Nasenraspel, FOMON .....	445	Tonsillenschnürer, EVES .....	468
STILLE, Rippenschere .....	480	TC Pinzette, chirurgisch .....	81/1	Tonsillenspritze .....	470
STILLE-BARRAYA, Gefäßpinzette .....	88	TC Pinzette, CUSHING .....	83	Tonsillenzange, BALLENGER .....	467
STILLE-HORSLEY, Knochenplitterzange .....	242	TC Pinzette, GILLIES .....	86	Tonsillenzange, BLOHMKE .....	467
STILLE-LISTON, Knochenplitterzange .....	242	TC Pinzette, SEMKEN .....	86	Tonsillenzange, NEGUS .....	467
STILLE-LUER, Hohlmeißelzange .....	239	TC Pinzette, WAGENSTEEN .....	89	Tonsillenzange, SAWTELL .....	467
STILLE-RUSKIN, Hohlmeißelzange .....	239	TC Pinzette, anatomisch .....	81	Tonsillenzange, SCHNIDT .....	467
STILLE-SHERMAN, Handbohrapparat .....	298	TC Schere, FREEMAN .....	74	Tonsillenzange, TYDING .....	468
Stimmgabel, HARTMANN .....	403	TC Schere, PECK-JOSEPH .....	74	Tonsillenzange, WHITE .....	467
Stimmgabel, LUCAE .....	404	TC Schere, REES .....	73	Tonsillotom, SLUDER-BALLENGER .....	470
Stimmgabeln .....	403, 404	TC Schere, GORNEY .....	73	Tonsillotom, TYDING .....	469
Stimmgabeln, RYDEL-SEIFFERT .....	404	TC Schere, KAYE .....	73	TOOK, Hornhutmesser .....	373
Stirnhöhliendilatator, RITTER-HALLE .....	433	TEALE, Hakenzange .....	583	Tourniquet, RUMEL-BELMONT .....	528
Stirnlampe, CLAR .....	22	TEBBETTS, Wundhaken .....	197	TOWNLEY, Schiebellehre .....	26
Stirnspiegel, ZIEGLER .....	21	Teleskop-Bohrdrahtstütze .....	299	TOWNSEND, Uterus-Biopsiezange .....	591
STOCKMANN, Penis-klemme .....	553/1	TERSON, Kapselpinzette .....	391	TOYNBEE, Ohrspekula .....	399
STONE, Schließklemme .....	545	TESSIER, Haken .....	463/3	Trachealhaken, BOSE .....	477
STONE-WATT, Darmklemme .....	545	TESSIER, Mobilisierhaken .....	463/3	Trachealdilatator, TROUSSEAU-BABY .....	476
STONE-WATT, Klemmschloß .....	545	T-Handgriff, HUDSON .....	300	Trachealdilatator, LABORDE .....	476
Stöbel .....	258, 259	T-Handgriff, Schnellkupplung .....	300, 301	Trachealdilatator, TROUSSEAU .....	476
Stöbel, CASPAR .....	258	THOMAS, Uteruskürette .....	599	Trachealhaken, ITERSON .....	477
STRABISMUS, Schere .....	58	THOMAS-GAYLOR, Biopsiezange .....	588	Trachealhaken, JACKSON .....	476
Strabismuspinzette, BONACCOLTO .....	385	THOMS-ALLIS, Darmfußzange .....	538	Trachealhaken, NEWS .....	477
Strabismuspinzette, DASTOOR .....	386	THOMSON-WALKER, Blasenwundspreizer .....	552	Trachealkanüle, CHEVALIER-JACKSON .....	479
Strabismuspinzette, JAMESON .....	385	Thoraxsperrerr, MERCEDES .....	489	Trachealkanüle, LUER .....	479
Strabismuspinzette, McCULLOUGH .....	385	THOREK, Gallenblasenschere .....	65/2	Trachealkanüle, WAGENER-MOSHER .....	477
STRANDELL-STILLE, Wundhaken .....	157	THUDICHUM, Nasenspekula .....	421	Trachealwundspreizer, BOSE .....	476
STRASSBURGER, Pinzette .....	89	TIECK-HALLE, Nasenspekula .....	423	Tracheotomie-Bestek .....	478
STRATTE, Nadelhalter .....	212	Tiefen-Messinstrument .....	594	Trachompinzette, KNAPP-LUER .....	393
STRAUSS, Penis-klemme .....	553/1	Tränenkanülide, ZIEGLER .....	231/2	Tränenkanaldilatator, ZIEGLER .....	381
STRUEMPEL, Fremdkörperzangchen .....	412	TILLEY, Ohrzangchen .....	411	Tränenkanaldilatator, CASTROVIEJO .....	381
STRULLY, neuro-chirurgische Schere .....	65	TISCHLER-DOWN, Uterus-Biopsiezange .....	591	Tränenkanaldilatator, WILDER .....	381
STRUYCKEN, Nasenzange .....	427	TISCHLER-KEVORKIAN, Uterus-Biopsiezange .....	592	Tränenkanalsonde, BOWMAN .....	381
SUBRAMANIAN, Kinder-Gefäßklemme .....	521	TISCHLER-MORGAN, Uterus-Biopsiezange .....	590, 591	Tränensackdissektor, LANG .....	378
SUBRAMANIAN-MINIATURE, Kinder-Gefäßklemme .....	521	TISCHLER-UP, Uterus-Biopsiezange .....	591	Tränensackhächen, KNAPP .....	375
Supercutschere .....	71	Titan-Arterienklemme, CRILE .....	107	Tränensackhächen, ROLLET .....	375





TRAVERS, Wundspreizer.....	172	Unterbindungsnadel, KRONECKER.....	219	Verbandschere, SMITH US ARMY.....	69/1
TRELAT, Scheidenspekula.....	571	Unterbindungsnadel, NELSON.....	219	Verbandschere, UNIVERSAL.....	70
Trepine, KEYES.....	608	Unterkieferhaken, HARGIS.....	463, 463/6	Verbandstofftrommel, SCHIMMELBUSCH.....	622
TROELTSCH, Nasenpinzette.....	424	Urethrotom, OTIS.....	553	Verbindungskabel.....	633
TROELTSCH, Ohrpinzette.....	410, 424	US-ARMY, Wundhaken.....	141	VERBRUGGE, Knochenhaltezeuge.....	245
TROEMNER, Perkussionshammer.....	24	USA, anatomische Pinzette.....	81	VERBRUGGE-MÜLLER, Knochenhebel.....	287
Trokar, SINOSKOPIE.....	205	USA Modell, Verbindungskabel.....	633	VERESS, Insufflationskanüle.....	206
Trokar, NELSON.....	205	Uterusdilator, GOODELL.....	581	Verlängerungsrohr, BRUENINGS.....	472
Trokar, OCHSNER.....	205	Uterusdilator, HANK.....	580	Verlängerungsstück.....	299
Trokar, UNIVERSAL.....	204	Uterusdilator, PRATT.....	580	VIENNA, Führungshohlsonde.....	221
Trokar, STANDARD (NELSON).....	204	Uterusdilator, SIMS.....	581	VIRCHOEW, Seziermesser.....	48
TROUSSEAU-BABY, Trachealdilator.....	476	Uterusdilator, WYLIE.....	581	VIRTUS (RALK), Splitterzange.....	92
TROUSSEAU, Trachealdilator.....	476	Uteruspolyenzange, DOYEN.....	585	VOLKMANN, Doppellöffel.....	257
TROUTMAN, Irispinzette.....	384	Uteruspolyenzange, KELLY.....	585	VOLKMANN, Knochenhaken.....	156
TROUTMAN, Muskelpinzette.....	389	Uteruspolyenzange, NOTO.....	585	VOLKMANN, scharfer Löffel.....	251, 257
TROUTMAN-CHRIS, Klingenbrecher.....	45	Uterus-Biopsiezaange, KEVORKIAN-PACIFIC.....	592	VOLKMANN, Wundhaken.....	153, 154, 156
TUBBS, Aortadilator.....	528	Uterus-Biopsiezange, SCHUMACHER.....	589	VOLTOLINI, Nasenspekula.....	421
Tubenkatheter f. SCHULTZE.....	596	Uterus-Biopsiezange, TISCHLER-KEVORKIAN.....	592	Vorbohrer, KUENTSCHER.....	321
Tuchklemme.....	133	Uterus-Biopsiezange, TOWNSEND.....	591	VO-MORE, Scheidenspekula.....	569
Tuchklemme, BALL AND SOCKET.....	133	Uterus-Biopsiezange, ALEXANDER.....	589		
Tuchklemme, BACKHAUS.....	132	Uterus-Biopsiezange, BABY-TISCHLER.....	592	W	
Tuchklemme, BACKHAUS-CLIP.....	132	Uterus-Biopsiezange, BURKE.....	590	WACHENFELDT, Wundklammerpinzette.....	224
Tuchklemme, BERNHARD.....	133	Uterus-Biopsiezange, BURKE-BABY.....	590	WADSWORTH-TODD, Cauter.....	378
Tuchklemme, DOYEN.....	133	Uterus-Biopsiezange, EPPENDORFER.....	590	WAGENER-MOSHER, Trachealkanüle.....	477
Tuchklemme, JONES.....	132	Uterus-Biopsiezange, KEVORKIAN.....	589, 591	WAGNER, Hähchen.....	409
Tuchklemme, JONES-CLIP.....	132	Uterus-Biopsiezange, MAXI GRASPER.....	593	WAGENSTEEN, Gefäßpinzette.....	89
Tuchklemme, LANE.....	133	Uterus-Biopsiezange, MINI-TOWNSEND-DOWN.....	591	WAGNER, Laminektomiezange.....	343
Tuchklemme, LORNA.....	133	Uterus-Biopsiezange, MINI-TOWNSEND-UP.....	591	WAGNER, SCHERE.....	67
Tuchklemme, MOYNIHAN.....	133	Uterus-Biopsiezange, TISCHLER-DOWN.....	591	WAGNER, Supercutschere.....	72
Tuchklemme, PEERS.....	132	Uterus-Biopsiezange, TISCHLER-MORGEN.....	590, 591	WALDMANN, Episotomie-Schere.....	64
Tuchklemme, ROEDER.....	132	Uterus-Biopsiezange, TISCHLER-UP.....	591	WALLICH, Abortuslöffel.....	607
Tuchklemme, SCHAEDEL.....	132	Uterus-Biopsiezange, WITTNER.....	589	WALSHAM, Septumrichtzange.....	449
Tuchklemme, TOHOKU.....	132	Uterus-Depressor, BRAUN.....	586	WALTON, Fremdkörperhohlmeißel.....	374
TUFFIER, Gewebefäßzange.....	110	Uterus-Depressor, SIMS.....	586	WALTON, Fingerringzäge.....	297
TUFFIER, Rippensperrer.....	487	Uterus-Dilator, HEGAR.....	578, 579	WALTON, Komedonenquetscher.....	608
TUFFIER, Wundhaken.....	147	Uterus-Faßzange, COLLIN.....	585	Wangenhalter.....	453, 451
Tumorfasszange, LANDOLT.....	341	Uterus-Faßzange, DARTIGUES.....	585	Wangenhalter, CAWOOD-MINNESOTA.....	451
Tumorpinzette, YASARGIL.....	97	Uterus-Faßzange, SOMER.....	585	Wangenhalter, STERNBERG.....	453
Tupferzange, BRYANT.....	137	Uterus-Kürette, BLAKE.....	595	WANGENSTEEN, Nadelhalter.....	210
Tupferzange, CHERON.....	137	Uterus-Kürette, BUMM.....	597, 598	WARTENBERG, Nervdrähtchen.....	25
Tupferzange, COLLIN.....	137	Uterus-Kürette, RECAMIER.....	597, 598	WATSON, Dermatoma.....	50
Tupferzange, FOERSTER.....	136	Uterus-Kürette, SIMS.....	597, 598	WATSON-CHEYNE, Elevator.....	283
Tupferzange, LISTER (SINUS).....	137	Uterus-Kürette, THOMAS.....	599	WATSON-CHEYNE, Sonde.....	199
Tupferzange, PELKMANN.....	137	Uterus-Löffel, SIMON.....	594	WATSON-WILLIAMS, Nasenzange.....	428
Tupferzange, RAMPLEY.....	136	Uterus-Löffel, GOURDET.....	599	Watteträger, FARRELL.....	203
TURNBULL, Nagelzange.....	609	Uterus-Löffel, SCHRÖDER.....	595	Watteträger, JOBSON-HORNE.....	203
TURREL, Mastdarmbiopsiezange.....	567	Uterus-Sonde, VALLEIX.....	586	Watteträger, REDA.....	203
TYDING, Tonsillenschnürer.....	469	Uterus-Sonde, COLLIN.....	586	Watteträger, TOBOLD.....	203
TYDING, Tonsillenzange.....	468	Uterus-Sonde, MARTIN.....	586	Watteträger, UCKERMANN.....	203
TYDING, Tonsillotom.....	469	Uterus-Sonde, SIMS.....	586	WAUGH, chirurgische Pinzette.....	83
U		Uterus-Zange, GREEN-ARMYTAGE.....	605	WEBER, Aortaklemme.....	501
USA MOD., Nabelschnur-Schere.....	64	V		WEBER, Starschlinge.....	378
UCKERMANN, Watteträger.....	203	VALLEIX, Uterus-Sonde.....	586	WEBSTER, Nadelhalter.....	208
Uhmacher Pinzette.....	90	Valve f. Bauchdeckenhalter, BALFOUR.....	183	WECKER, Augenschere.....	75
ULRICH, Knochenhaltezeuge.....	248	Valve f. Bauchdeckenhalter, HORGAN.....	183	WECKER, Iris spatel.....	378
ULRICH, Kornzange.....	135	Valven f. Scheidenspekula, O'SULLIVAN-O'CONNOR.....	576	WEEK, Lidsperrer.....	370
ULTA-LIGHT, Pinzette, atrauma.....	95	VAN BUREN, Dilatationsbougie.....	554	WEIL-BLAKESEY, Nasenzange.....	426
UNI I, Diagnostik-Besteck.....	13	VAN BUREN, Knochenhaltezeuge.....	249	WEITLANER, Wundspreizer.....	169
UNI III, Diagnostik-Besteck.....	15	VAN DOREN, Biopsiezange.....	588	WEITLANER-WULLSTEIN, Wundspreizer.....	169
UNIVERSAL, Drahtschere.....	67	VANNAS, Augenschere.....	79	WELLER, Präparierschere.....	53/2
UNIVERSAL, Endoskophalterung.....	188	VARADY, Varizeninstrument.....	202	WELLS, Enukektionslöffel.....	378
UNIVERSAL, Pulverbläser.....	405	Varizeninstrument, VARADY.....	202	WERTHEIM, gynäkologische Schere.....	62
UNIVERSAL, Sterilisierzange.....	227	Vasektomieklammer.....	553/1	WERTHEIM, Hysterektomiechere.....	63
UNIVERSAL, Trokar.....	204	Verbandschere.....	70	WERTHEIM, Hysterektomieklammer.....	124, 128
UNIVERSAL, Verbandschere.....	70	Verbandschere, BERGMANN.....	69/1	WERTHEIM-CULLEN, Nierenstiellammer.....	125
Universalsgriff, HUBER.....	472	Verbandschere, BRUNS.....	70	WEST, Hohlmeißel.....	442/1
Universelle Wundhakenhalterung für Armsystem.....	188	Verbandschere, ESMARCH.....	69/2	WEST, Nasenmeißel.....	442/1
UNNA, Komedonenquetscher.....	608	Verbandschere, KNOWLES.....	70	WESTCOTT, Augenschere.....	75
Unterbindungsnadel.....	218	Verbandschere, LISTER.....	69/1	WESTMACOTT, Nasentamponzange.....	424
Unterbindungsnadel, SCHMIEDEN-DICK.....	219	Verbandschere, LORENZ.....	70	WESTON, Rektalschnürer.....	566
Unterbindungsnadel, COOPER.....	219	Verbandschere, REDA EXCENTER.....	69/2	WHEELER, Disziplinsmesser.....	373
Unterbindungsnadel, DESCHAMPS.....	218	Verbandschere, SEUTIN.....	69/2	WHEELER, Zykliodials spatel.....	379
				WHITE, Tonsillenzange.....	467



WIEDER, Zungendrucker .....	452	Wundhaken, ISRAEL .....	162	WYLIE, Uterus-Dilatator .....	581
WIENER, Antrumraspel .....	443	Wundhaken, JANSEN .....	168	Y	
WIENER, Irishähchen .....	375	Wundhaken, KELLY .....	164	YANCOSKIE, Wundhaken .....	198
WIGMORE, Gipsmesser .....	229	Wundhaken, KELLY-GRIP .....	142	YANKAUER, Saugrohr .....	27
WIKSTROEM, Arterienklemme .....	117	Wundhaken, KLAPP .....	150	YANKAUER, Tonsillen-Dissektor .....	465
WILDE, Polypenschürer .....	411, 433/2	Wundhaken, KOCHER-LANGENBECK .....	159	YASARGIL, Galeahaken .....	330
WILDE (TROELTSCH), Ohrpinzette .....	410	Wundhaken, KOERTE .....	162	YASARGIL, Gefäßclip .....	345 - 356
WILDER, Starschlinge .....	378	Wundhaken, LAHEY .....	157	YASARGIL, SAUGROHR .....	337/1
WILDER, Tränenkanal-Dilatator .....	381	Wundhaken, LANGENBECK .....	158, 159	YASARGIL, Tumorphinzette .....	97
WILLET-MARTEL, Faßzange .....	110	Wundhaken, LANGENBECK-GREEN .....	153	YEOMAN, Mastdam-Biopsiezange .....	566, 567
WILLIAMS, Darmfaßzange .....	539	Wundhaken, LITTLE .....	157	YOUNG-BOOMERANG, Nadel .....	220
WILLIAMS, Lidsperrer .....	370	Wundhaken, LOVE .....	465	YOUNG, Prostatahaken .....	550
WILLIAMS, Schraubenzieher .....	323	Wundhaken, MATHIEU .....	141	YOUNG, Zungenzange .....	453
WILLIGER, Hammer .....	271	Wundhaken, MIDDELDORPF .....	160	Z	
WILLIGER, Raspator .....	276	Wundhaken, MIKULICZ .....	163	Zahnfleischschere, LA GRANGE .....	69
WILLIGER, scharfer Löffel .....	255, 257	Wundhaken, NAGER .....	465	Zahnfleischschere, Supercut, LA GRANGE .....	72
Winkelmesser, MOELTGEN .....	25	Wundhaken, OBWEGESER .....	460, 461	Zahnfleischschere, GOLDMAN-FOX .....	67
WINTER, Abortuszange .....	606	Wundhaken, OLLIER .....	162	Zahnfleischschere, LOCKLIN .....	69
Wirbelkörperspreizer, CLOWARD .....	339	Wundhaken, PARKER .....	139	Zahnfleischschere, QUINBY .....	67
Wirbelkörperspreizer, INGE .....	339	Wundhaken, RAGNELL .....	140	Zahnpinzette, LONDON-COLLEGE .....	93
WITTNER, Uterus-Biopsiezange .....	589	Wundhaken, RAMUS .....	461	Zahnpinzette, MERIAM .....	93
WOLFF, Gipsabreißzange .....	233	Wundhaken, RICHARDSON .....	142	Zange, JURASZ .....	471
WOODSON, Dura-Dissektor .....	333	Wundhaken, RICHARDSON-GRIP .....	142	ZAUFAL, Ohrhebel .....	409
WORST, Sonde .....	381	Wundhaken, RICHARDSON-EASTMAN .....	142	ZAUFAL-JANSEN, Hohlmeißelzange .....	238
WRIGLEY, Geburtszange .....	602	Wundhaken, ROSE .....	140	ZAUFAL-JANSEN, Ohrhebel .....	409
WULLSTEIN, Messer .....	418	Wundhaken, ROUX .....	139	ZEIGLER, Lidsperrer .....	371
WULLSTEIN, Mikro-Löffelzängchen .....	416	Wundhaken, ROUX-BABY .....	140	ZENKER, Arterienklemme .....	118
WULLSTEIN, Mikro-Ohrzängchen .....	416	Wundhaken, ROUX-Mini .....	140	ZENKER, Wundhaken .....	161
WULLSTEIN, Sauggriff .....	338	Wundhaken, SAUERBRUCH .....	164, 166	zerlegbare Stanze, FERRIS-SMITH-KERRISON .....	344/2
WULLSTEIN, Wundspreizer .....	171	Wundhaken, SENN-GREEN .....	153	ZIEGLER, Disziionsmesser .....	373
Wundhaken .....	463/3	Wundhaken, SENN-MILLER .....	143	ZIEGLER, Irismesser .....	372
Wundhaken, ANDERSON .....	198	Wundhaken, SIMON .....	164	ZIEGLER, Stirnspiegel .....	21
Wundhaken, AUFRANC-COBRA .....	289	Wundhaken, SPINA-NASALIS .....	461	ZIEGLER, Tränenkanal-Dilatator .....	381
Wundhaken, BREAST .....	198	Wundhaken, STRANDELL-STILLE .....	157	ZIELKE, Hohlmeißel .....	264
Wundhaken, CORONAL-BLOW-LIFT .....	198	Wundhaken, VOLKMANN .....	153, 154, 156	Zirkular-Stanze .....	432
Wundhaken, FERRIERA .....	197	Wundhaken, ZENKER .....	161	ZÖLLNER, Saugrohr .....	337/1
Wundhaken, FINSEN .....	168	Wundhaken, KOCHER .....	155, 159, 160, 163	Zubehör f. Autopsiesäge .....	231/2, 231/3
Wundhaken, FREEMAN .....	198	Wundhaken, US-ARMY/PARKER-LANGENBECK .....	141	Zughaken, KIRSCHNER .....	313
Wundhaken, KÖNIG .....	153	Wundhakenhalterung .....	188	Zughebel, BARTON .....	603
Wundhaken, MEYERDING .....	177	Wundklammer, MICHEL .....	224	Zughebel, BILL .....	604
Wundhaken, MORRIS .....	164	Wundklammerpinzette, HEGENBARTH .....	224	Zughebel, LUIKART-BILL .....	604
Wundhaken, MURPHY .....	156	Wundklammerpinzette, MICHEL .....	224	Zugseil f. NABATOFF .....	201
Wundhaken, St. MARKS .....	165	Wundklammerpinzette, WACHENFELDT .....	224	Zungendrucker, ANDREW .....	452
Wundhaken, TEBBETS .....	197	Wundklammerzange, CHILDE .....	224	Zungendrucker, DAVIS-BOYLE .....	455
Wundhaken, TUFFIER .....	147	Wundklammerzange, COLLIN .....	224	Zungendrucker, DINGMANN .....	456
Wundhaken, YANCOSKIE .....	198	Wundklammerzange, COLLIN .....	224	Zungendrucker, HARTMANN .....	452
Wundhaken, ALM .....	168	Wundklammerzange, RICHTER-HEATH .....	224	Zungendrucker, KILNER-DOUGHTY .....	456
Wundhaken, BRUNNER .....	167	Wundlöffel, ARRUGA .....	378	Zungendrucker, TOBOLD .....	453
Wundhaken, COLLIN .....	139	Wundnahtbesteck .....	225, 226	Zungendrucker, WIEDER .....	452
Wundhaken, COLLIN-HARTMANN .....	141	Wundsperrer, CLOWARD .....	178	Zungenspatel .....	451
Wundhaken, COOLEY .....	148	Wundspreizer, ADSON .....	172 - 174	Zungenspatel, BRUENINGS .....	451
Wundhaken, CORYLLOS .....	166	Wundspreizer, CASPAR .....	179	Zungenspatel, BUCHWALD .....	451
Wundhaken, CRILE .....	140	Wundspreizer, MAYO-ADAMS .....	171	Zungenspatel, DOUGHTY .....	458
Wundhaken, CUSHING .....	151, 152	Wundspreizer, NORDFOLK/NORWICH .....	172	Zungenspatel, FRENZEL .....	451
Wundhaken, DAVIDSON (Scapula) .....	166	Wundspreizer, PERKINS .....	168	Zungenspatel, KROENIG .....	451
Wundhaken, DEAVER .....	145, 146	Wundspreizer, PLESTER .....	171	Zungenspatel, MAYO .....	451
Wundhaken, DEAVER-GRIP .....	146	Wundspreizer, SCALP-CONTOUR .....	169	Zungenspatel, MORITZ-SCHMIDT .....	452
Wundhaken, DESMARRS .....	151	Wundspreizer, TRAVERS .....	172	Zungenspatel, RING .....	455
Wundhaken, DOYEN .....	163	Wundspreizer, WEITLANER-WULLSTEIN .....	169	Zungenspatel, RUSSEL-DAVIS .....	458
Wundhaken, DOYEN-STILLE .....	167	Wundspreizer, WULLSTEIN .....	171	Zungenzange, COLLIN .....	453
Wundhaken, FARABEUF .....	139	Wundspreizer, ADSON-BABY .....	173	Zungenzange, YOUNG .....	453
Wundhaken, FRITSCH .....	163	Wundspreizer, ANDERSON-ADSON .....	172	Zwischenknochen-Messer .....	44
Wundhaken, GIL-VERNET .....	152	Wundspreizer, BECKMANN .....	176	Zwischenstück f. SCHULTZE Salpingograph .....	596
Wundhaken, GOELET .....	141	Wundspreizer, BECKMANN-ADSON .....	175	Zyklodialysespatel, BANGERTER .....	379
Wundhaken, GREEN .....	160	Wundspreizer, BECKMANN-EATON .....	176	Zyklodialysespatel, ELSCHNIG .....	379
Wundhaken, HARGIS .....	463	Wundspreizer, BOSE .....	476	Zyklodialysespatel, HIRSCHMANN .....	379
Wundhaken, HARRINGTON .....	147	Wundspreizer, DARLING .....	178	Zyklodialysespatel, WHEELER .....	379
Wundhaken, HARRINGTON-PEMBERTON .....	147	Wundspreizer, HENLEY .....	170	Zyklodialysespatel, CASTROVIEJO .....	379
Wundhaken, HEANEY .....	164	Wundspreizer, MARTIN .....	175/1		
Wundhaken, HIBBS .....	164	Wundspreizer, MEYERDING .....	180		
Wundhaken, HOESEL .....	167	Wundspreizer, MOLLISON .....	171		
Wundhaken, HOFER .....	465	Wundspreizer, PLESTER .....	171		
Wundhaken, HOLZHEIMER .....	168	Wundspreizer, WEITLANER .....	169		



ABDOMINAL- A. BOWEL SPATULA KÜMMEL.....143/2, 144  
 ABDOMINAL RETRACTOR KIRSCHNER.....187, 187/1  
 ABDOMINAL RETRACTORS BABY GOSSET.....181  
 ABDOMINAL RETRACTORS BALFOUR.....182  
 ABDOMINAL RETRACTORS BALFOUR BABY.....182  
 ABDOMINAL RETRACTORS BALFOUR-US.....184  
 ABDOMINAL RETRACTORS CHARNELY.....289  
 ABDOMINAL RETRACTORS COLLIN.....190  
 ABDOMINAL RETRACTORS COLLIN-LOKITE.....191  
 ABDOMINAL RETRACTORS DENIS-BROWNE.....186  
 ABDOMINAL RETRACTORS DOYEN.....189/1  
 ABDOMINAL RETRACTORS FRAZIER.....181  
 ABDOMINAL RETRACTORS GELPI.....189/1, 189/2  
 ABDOMINAL RETRACTORS GOSSET.....181  
 ABDOMINAL RETRACTORS KIRSCHNER.....185, 187  
 ABDOMINAL RETRACTORS RICARD.....191  
 ABDOMINAL RETRACTORS RIGBY.....189/2  
 ABDOMINAL RETRACTORS ROCHARD.....186  
 ABDOMINAL SPATULA KADER.....143/1  
 ABDOMINAL SPATULA LERICHE.....143/2  
 ABLI OPHTHALMOLOGIC SCISSORS.....58  
 ABRAHAM TONSIL FORCEP.....468  
 ABRAHAM TONSIL KNIVES.....466  
 ACCESSORIES FOR AUTOPY SAW.....231/3  
 ADENOID CURETTE BARNHILL.....450  
 ADENOID CURETTE BECKMANN.....450  
 ADENOID CURETTEST.CLAIR-THOMSON.....450  
 ADENOTOM LA FORCE.....450  
 ADLERKREUTZ VASCULARTISSUE FORCEPS.....84  
 ADSON RETRACTORS.....173  
 ADSON ANATOMIC TISSUE FORCEPS.....81/2  
 ADSON ANATOMIC TISSUE FORCEPS.....81/2  
 ADSON BABY HEMOSTATIC CLAMP.....113  
 ADSON BONE RONGEUR.....236  
 ADSON DURAHOOK.....328  
 ADSON HEMOSTATIC CLAMP.....112  
 ADSON HOLDING CLAMP.....298  
 ADSON HYPOPHYSE-TISSUE FORCEPS.....334  
 ADSON MICRO ANATOMIC TISSUE FORCEPS.....81/2  
 ADSON MICRO SURGICAL TISSUE FORCEPS.....81/2  
 ADSON NEEDLE HOLDER.....211  
 ADSON RASPATORIES.....282  
 ADSON RETRACTORS.....172, 173, 174  
 ADSON SUCTION TUBE.....337  
 ADSON SURGICAL TISSUE FORCEPS.....81/2  
 ADSON-BROWN SURGICAL TISSUE FORCEPS.....82  
 ADSON-DEBAKEY ATRAUMATIC FORCEPS.....81/2  
 AHLE OBWEGESER.....463  
 AIR BLOWER.....405  
 AIR BLOWER POLITZER.....406  
 AIR INJECTION EYE CANNULA.....394  
 AIR PUMP.....295  
 ALAN-PARKS RECTAL-SPECULA.....561  
 ALDERDYCE ELEVATOR.....282  
 ALEXANDER BIOPSY FORCEPS.....589  
 ALEXANDER CHISELS.....259  
 ALEXANDER RASPATORIES.....276  
 ALLEN APPENDIX BOWEL CLAMP.....544  
 ALLIS BOWEL GRASPING FORCEPS.....537  
 ALLIS-ADAIR BOWEL GRASPING FORCEPS.....537  
 ALLIS-BABY BOWEL GRASPING FORCEPS.....537  
 ALLISON LUNG SPATULA.....489  
 ALM RETRACTOR.....168  
 ALVIS FOREIGN-BODY CURETTE.....374  
 AMNIOSCOPE.....601  
 AMNIOTOME BEACHAM.....586  
 AMPUTATION KNIVES CATLIN.....44  
 AMPUTATION KNIVES LANGENBECK.....44  
 AMPUTATION KNIVES LISTON.....44  
 AMPUTATION KNIVES REDA.....44  
 AMPUTATION SAW BIER.....296  
 AMPUTATION SAW CHARRIERE.....296  
 AMPUTATION SAW SATTERLEE.....296

ANAL RETRACTOR SMITH-BUIE.....561  
 ANAST.KL. DE MARTEL-WOLFSON.....546  
 ANASTOMOSIS CLAMP BECK.....516  
 ANASTOMOSIS CLAMP BECK.....520  
 ANASTOMOSIS CLAMP COOLEY.....519, 520  
 ANASTOMOSIS CLAMP COOLEY-DEHRA.....519  
 ANASTOMOSIS CLAMP DEBAKEY.....505  
 ANASTOMOSIS CLAMP LAMBERT-KAY.....505  
 ANATOMIC TISSUE FORCEPS BROPHY.....84  
 ANATOMIC TISSUE FORCEPS.....81  
 ANATOMIC TISSUE FORCEPS ADSON.....81/2  
 ANATOMIC TISSUE FORCEPS ADSON MICRO.....81/2  
 ANATOMIC TISSUE FORCEPS BONNEY.....88  
 ANATOMIC TISSUE FORCEPS CUSHING.....83  
 ANATOMIC TISSUE FORCEPS CUSHING-TAYLOR.....87  
 ANATOMIC TISSUE FORCEPS DUEHSEN.....84  
 ANATOMIC TISSUE FORCEPS GERALD.....86  
 ANATOMIC TISSUE FORCEPS MCINDOE.....85  
 ANATOMIC TISSUE FORCEPS POTTS-SMITH.....81  
 ANATOMIC TISSUE FORCEPS SEMKEN.....86  
 ANATOMIC TISSUE FORCEPS TAYLOR.....87  
 ANATOMIC TISSUE FORCEPS TC.....81  
 ANATOMIC TISSUE FORCEPS TYPE USA.....81  
 ANATOMIC TISSUE FORCEPSSTILLE.....81  
 ANDERSON ADSON RETRACTORS.....172  
 ANDERSON RETRACTOR.....198  
 ANDREW TONGUE DEPRESSOR.....452  
 ANDREW-PYNCHON SUCTION TUBE.....28  
 ANESTOPHON.....23  
 ANEURYSM CLAMP DEBAKEY-BAHNSON.....506  
 ANEURYSM CLIPS APPLIER FORCEPS.....357,358, 359, 360  
 ANEURYSM VASCULAR CLIP YASARGIL.....349, 350, 351, 352, 353, 354, 355, 356  
 ANOSCOPE HIRSCHMANN.....562  
 ANOSCOPE IVES-FANSLER.....562  
 ANTRUM CURETTE COAKLEY.....449  
 ANTRUM RASP GALLAHER.....446  
 ANTRUM RASP LEWIS.....443  
 ANTRUM-CURETTE.....435  
 ANVIL NAILSPALTFORCEPS.....613  
 AORTIC DILATOR COOLEY.....528  
 AORTIC-DILATOR TUBBS.....528  
 APPENDIXBOWEL CLAMP ALLEN.....544  
 APPENDIXBOWEL CLAMP KLEINSCHMIDT.....544  
 APPLIER FORCEPS ANEURISMEN CLIPS.....357,358, 359, 360  
 APPLIER FORCEPS BIEMER.....361, 366  
 APPLIER FORCEPS MEHDORN.....362  
 APPLIERFORCEPS JOHNS-HOPKINS.....104  
 APPLIERFORCEPS MC KENZIE.....326  
 APPLIERFORCEPS SMITHWICK.....326  
 APPLIERFORCEPS SWEET.....326  
 APPLING FORCEPS RANEY.....327  
 APPROXIMATOR BIEMER.....366  
 APPROXIMATOR BIEMER-MÜLLER.....363  
 APPROXIMATOR MÜLLER.....364  
 ARCHER SPLINTERFORCEPS.....92  
 ARL CATARACT LOOP.....378  
 ARMSYSTEM.....188  
 ARRUGA CAPSULAR FORCEPS.....391  
 ARRUGA EXTRACTION HOOK.....375  
 ARRUGA EYE SPECULA.....370  
 ARRUGA NEEDLE HOLDER.....214  
 ARRUGA WOUND CURETTE.....378  
 ASCH SEPTUM STRAIGHTENING FORCEPS.....449  
 ATRAUMA BULLDOG CLAMP.....100  
 ATRAUMA BULLDOG CLAMP.....100, 102  
 ATRAUMA CLAMP DEBAKEY.....100  
 ATRAUMA CLAMP DEBAKEY.....103  
 ATRAUMA CLAMP GLOVER.....100  
 ATRAUMA-BULLDOG CLAMP GLOVER.....103  
 ATRAUMA-NEONATAL CLAMP.....523  
 ATRAUMATIC FORCEPS ADSON-DEBAKEY.....81/2

ATRAUMATIC TISSUE FORCEPS DEBAKEY.....99  
 AUFRANC RETRACTOR.....289  
 AUFRREIBER KUENTSCHER.....321  
 AUFRICHT NOSE HOOK.....447  
 AUFRICHT NOSE RASP.....443  
 AURIKELCLAMP HARKEN.....503  
 AUTOPSY KNIVES.....48  
 AUTOPSY SAW.....231/1  
 AUVARD VAGINAL SPECULA.....576  
 AWL.....304  
 AWL HARGIS.....463  
 AWL PERTHES.....304  
 AXENFELD CHALAZIO CURETTE.....377  
 AYER CHALAZIO TISSUE FORCEPS.....393

**B**

BABCOCK BOWEL GRASPING FORCEPS.....539  
 BABINSKI PERCUSSION HAMMER.....24  
 BABY BURKE BIOPSY FORCEPS.....590  
 BABY GOSSET ABDOMINALRETRACTORS.....181  
 BABY METZENBAUM SUPERCUT SCISSORS.....71  
 BABY TISCHLER RONGEUR.....592  
 BABY WEBSTER NEEDLE HOLDER.....208  
 BABY YANKAUER SUCTION TUBE.....27  
 BABY-KOCHER BOWEL CLAMP.....540  
 BABY-OLSEN-HEGAR NEEDLE HOLDER.....212  
 BABYPHON SPHYGMOMANOMETER.....10  
 BACK HOLDER ABDOMINAL RETRACTOR SYSTEM.....192, 193, 194, 195  
 BACKHAUS TOWEL CLAMP.....132  
 BACKHAUS-CLIP.....132  
 BAILEY RIB SPREADER.....489  
 BAILEY-BABY RIB SPREADER.....489  
 BAILEY-GIBBON RIB SPREADER.....489  
 BAINBRIDGE HEMOSTATIC CLAMP.....120  
 BAINBRIDGE VASCULAR CLAMP.....495  
 BAKES GALL DUCT DILATOR.....532  
 BALFOUR ABDOMINALRETRACTORS.....182  
 BALFOUR BABY ABDOMINALRETRACTORS.....182  
 BALFOUR HOOK.....193  
 BALFOUR-US ABDOMINALRETRACTORS.....184  
 BALL AND SOCKET TOWEL CLAMP.....133  
 BALL ELECTRODE MONOPOLAR.....628, 629  
 BALLENGER SCHWINGKNIVES.....436  
 BALLENGER SEPTUM ELEVATOR.....439  
 BALLENGER TONSIL FORCEPS.....467  
 BANDAGE CUFF.....295  
 BANDAGE DRUMSSCHIMMELBUSCH.....622  
 BANDAGE SCISSORS.....70  
 BANDAGE SCISSORS BERGMANN.....69/1  
 BANDAGE SCISSORS BRUNS.....70  
 BANDAGE SCISSORS ESMARCH.....69/2  
 BANDAGE SCISSORS KNOWLES.....70  
 BANDAGE SCISSORS LISTER.....69/1  
 BANDAGE SCISSORS LORENZ.....70  
 BANDAGE SCISSORS REDA EXCENTER.....69/2  
 BANDAGE SCISSORS SEUTIN.....69/2  
 BANDAGE SCISSORS SMITH US ARMY.....69/1  
 BANDAGE SCISSORS UNIVERSAL.....70  
 BANE-HARTMANN BONE RONGEUR.....237  
 BANGERTER CYCLODIALYSIS SPATULA.....379  
 BARACANI INTERCHANGEABLE TIPS.....472  
 BARANY AIR BLOWER.....405  
 BARBARA HOOK.....419  
 BARBARA NEEDLE.....419  
 BARKAN GONIOTOMY KNIVES.....373  
 BARNHILL ADENOID CURETTE.....450  
 BARON SUCTION TUBE.....336  
 BARR RECTAL SPECULA.....559  
 BARRAQUER CILIA FORCEPS.....395  
 BARRAQUER EYE SPECULA.....370  
 BARRAQUER EYESCISSORS.....75  
 BARRAQUER FIXATION FORCEPS.....390





BARRAQUER KERATOPLAST-KNIVES.....	373	BIPOLAR-CABLE.....	633	BONE HOLDING FORCEPS.....	249
BARRAQUER NEEDLE HOLDER.....	217	BIPOLAR-TISSUE FORCEPS.....	630, 631	BONE HOLDING FORCEPS BIRCHER-GANSKE.....	246
BARRAQUER NEEDLE HOLDER.....	216, 217	BIPOLAR-TISSUE FORCEPS BAJONETT.....	632	BONE HOLDING FORCEPS DINGMANN.....	246
BARRAQUER-KATZIN IRIS TISSUE FORCEPS.....	384	BIRCHER-GANSKE BONE HOLDING FORCEPS.....	246	BONE HOLDING FORCEPS FARABEUF.....	243
BARRET HOOK FORCEPS.....	582	BIRKETT HEMOSTATIC CLAMP.....	116	BONE HOLDING FORCEPS FARABEUF-L.....	243
BARTON OBSTETRICAL FORCEPS.....	603	BISHOP-HARMAN IRIS TISSUE FORCEPS.....	386	BONE HOLDING FORCEPS FERGUSSON.....	243
BATTERY HANDLE F. COLD LIGHT.....	33	BISHOP-HARMAN IRRIGATION CANNULA.....	394/1	BONE HOLDING FORCEPS KERN.....	244
BATTERY HANDLE F. WARM LIGHT.....	32	BLADDER RETRACTORS LEGUE.....	553	BONE HOLDING FORCEPS LAMBOTTE.....	244
BAUMGARTNER NEEDLE HOLDER.....	208	BLADDER RETRACTORS MILLIN.....	552	BONE HOLDING FORCEPS LANE.....	244
BEACHAM AMNIOTOME.....	586	BLADDER RETRACTORS THOMSON-WALKER.....	552	BONE HOLDING FORCEPS LANGENBECK.....	243
BECHERT NUCLEUS ROTATOR.....	379	BLADDER RETRACTORSJUDD-MASSON.....	552	BONE HOLDING FORCEPS LEWIN.....	246
BECK ANASTOMOSIS KL.....	520	BLADDER SPATULA KOCHER.....	552	BONE HOLDING FORCEPS REDA.....	246, 247
BECK VASCULAR CLAMP.....	516	BLADDER SPATULA LEGUEU.....	552	BONE HOLDING FORCEPS REILL.....	248
BECKER CYSTOTOM.....	375	BLADDER SPREADER MILLIN.....	553	BONE HOLDING FORCEPS SEMB.....	243
BECKMANN ADENOID CURETTE.....	450	BLADE SCALPEL.....	42	BONE HOLDING FORCEPS ULRICH.....	248
BECKMANN RETRACTORS.....	176	BLADEBREAKER CASTROVIEJO.....	45	BONE HOLDING FORCEPS VAN BUREN.....	249
BECKMANN-ADSON RETRACTORS.....	175	BLADEBREAKER REDA.....	45	BONE HOLDING FORCEPS VERBRUGGE.....	245
BECKMANN-EATON RETRACTORS.....	176	BLADEBREAKER TROUTMAN-CHRIS.....	45	BONE KNIVES.....	44
BED PAN.....	621	BLADE-REMOVER.....	42	BONE LEVERS.....	284, 288
BEEBEE CROWNSCISSORS.....	68	BLADES RAZOR.....	45	BONE LEVERS BENNETT.....	283
BEER CILIA FORCEPS.....	395	BLAKE GALL STONE FORCEPS.....	531	BONE LEVERS BLOUNT.....	288
BEESON PLASTER RETRACTOR.....	232	BLAKE UTERINE CURETTE.....	595	BONE LEVERS HOHMANN.....	284
BELLUCCI MICRO-EAR SCISSORS.....	413	BLOHMKE TONSIL FORCEPS.....	467	BONE LEVERS HOHMANN.....	285
BELLUCCI MICRO-SCISSORS.....	417	BLOOD VESSEL CLAMP DIETRICH.....	510	BONE LEVERS HOHMANN MINI.....	286
BENDER.....	322	BLOOD VESSEL CLAMP MORRIS-DEBAKEY.....	506	BONE LEVERS KOENIG.....	284
BENDER LANE.....	325	BLOOD VESSEL CLAMP WEBER.....	501	BONE LEVERS LANGE-HOHMANN.....	286
BENGOLEA HEMOSTATIC CLAMP.....	112	BLOUNT BONE LEVERS.....	288, 289	BONE LEVERS SMILLIE.....	291
BENNETT BONE LEVERS.....	283	BLOWER KABIESKE.....	405	BONE LEVERS VERBRUGGE-MÜLLER.....	287
BENSAUDE PROCTOSCOPE.....	565	BLUMENTHAL BONE RONGEUR.....	236	BONE PLATE HOLDING FORCEPS LANE.....	325
BENSON PYLORUSRETRACTOR.....	544	BODENHAMMER RECTAL-SPECULA.....	559	BONE RONGEUR ADSON.....	236
BERENS DISCISION KNIVES.....	372	BOEHLER EXTENSION BOW.....	312	BONE RONGEUR BANE-HARTMANN.....	237
BERGMANN BANDAGE SCISSORS.....	69/1	BOERMA OBSTETRICAL FORCEPS.....	604	BONE RONGEUR BEYER.....	237, 238
BERGMANN HAMMER.....	272	BOETTCHER TONSIL SCISSORS.....	59	BONE RONGEUR BLUMENTHAL.....	236
BERKE MUSCLE FORCEPS.....	389	BÖHLER BONE CUTTING FORCEPS.....	241	BONE RONGEUR BOEHLER.....	238
BERLINER PERCUSSION HAMMER.....	24	BÖHLER BONE RONGEUR.....	238	BONE RONGEUR CLEVELAND.....	235
BERNHARD TOWEL CLAMP.....	133	BOIES ELEVATOR.....	277	BONE RONGEUR ECHLIN.....	240
BERRY WIRE FORCEPS.....	319	BONACCOLTO STRABISMUS FORCEPS.....	385	BONE RONGEUR FRIEDMAN-MICRO.....	234
BETHUNE RIB SCISSORS.....	481	BONE CURETTES.....	255, 256	BONE RONGEUR FRIEDMAN-MINI.....	234
BEYER BONE RONGEUR.....	237, 238	BONE CURETTES BRUNS.....	251, 254	BONE RONGEUR FRYKHOLM.....	240
BIEMER APPLIER FORCEPS.....	361, 366	BONE CURETTES BUSHE.....	256	BONE RONGEUR JANSEN.....	237
BIEMER APPROXIMATOR.....	366	BONE CURETTES DAUBENSPECK.....	255	BONE RONGEUR KLEINERT-KUTZ.....	237
BIEMER VASCULAR CLIP.....	361	BONE CURETTES HALLE.....	253	BONE RONGEUR LEMPERT.....	237
BIEMER-MÜLLER APPROXIMATOR.....	363	BONE CURETTES JACOBSON.....	257	BONE RONGEUR LUER.....	236
BIER AMPUTATION SAW.....	296	BONE CURETTES JANSEN.....	257	BONE RONGEUR MARQUARD.....	239
BILLEAU EAR LOOP.....	409	BONE CURETTES LEMPERT.....	256	BONE RONGEUR MAYFIELD.....	238
BIOPSY CURETTE HEANY.....	587	BONE CURETTES MARTINI.....	257	BONE RONGEUR MEAD.....	235
BIOPSY CURETTE KEVORKIAN.....	587	BONE CURETTES SCHEDE.....	251	BONE RONGEUR OLIVECRONA.....	237
BIOPSY CURETTE NOVAK.....	587	BONE CURETTES SCOVILLE.....	253	BONE RONGEUR RUSKIN.....	239
BIOPSY CURETTE RANDALL.....	587	BONE CURETTES SPINAL.....	253	BONE RONGEUR SAUERBRUCH.....	240
BIOPSY CURETTE TYPE MÜNCHEN.....	587	BONE CURETTES SPRATT.....	251	BONE RONGEUR SCAGLIETTI.....	240
BIOPSY FORCEPS ALEXANDER.....	589	BONE CURETTES VOLKMANN.....	251, 257	BONE RONGEUR SEMB.....	240
BIOPSY FORCEPS BABY BURKE.....	590	BONE CURETTES WILLIGER.....	255, 257	BONE RONGEUR SMITH-PETERSEN.....	238
BIOPSY FORCEPS BURKE.....	590	BONE CUTTING FORCEPS BOEHLER.....	241	BONE RONGEUR STELLBRINK.....	234
BIOPSY FORCEPS EPPENDORFER.....	590	BONE CUTTING FORCEPS LISTON.....	241	BONE RONGEUR ZAUFAL-JANSEN.....	238
BIOPSY FORCEPS FAURE.....	588	BONE CUTTING FORCEPS MCINDOE.....	241	BONE RONGEURLEKSELL-STILLE.....	240
BIOPSY FORCEPS KERVORKIAN-PACIFIC.....	592	BONE CUTTING FORCEPS RUSKIN.....	241	BONE RONGEURSTILLE-LUER.....	239
BIOPSY FORCEPS KEVORKIAN.....	589	BONE CUTTING FORCEPS SEMB.....	242	BONE RONGEURSTILLE-RUSKIN.....	239
BIOPSY FORCEPS KEVORKIAN.....	591	BONE CUTTING FORCEPSCOTTLE-K.....	241	BONEFENDER NAIL BENDER.....	322
BIOPSY FORCEPS MAXI GRASPER.....	593	BONE CUTTING FORCEPSSTILLE.....	241, 242	BONEHOOK VOLKMANN.....	156
BIOPSY FORCEPS SCHUBERT.....	588	BONE FILES.....	612/1	BONERASP.....	294
BIOPSY FORCEPS SCHUMACHER.....	588, 589	BONE HAND DRILLS BUNELL.....	299	BONERASP PUTTI.....	294
BIOPSY FORCEPS THOMAS-GAYLOR.....	588	BONE HAND DRILLS HUDSON.....	299	BONEWIRE SOFT.....	314
BIOPSY FORCEPS TISCHLER-DOWN.....	591	BONE HAND DRILLS KIRSCHNER.....	299	BONN IRIS TISSUE FORCEPS.....	387
BIOPSY FORCEPS TISCHLER-KERVORKIAN.....	592	BONE HAND DRILLS MOORE.....	298	BONNEY ANATOMIC TISSUE FORCEPS.....	88
BIOPSY FORCEPS TISCHLER-MORGAN.....	591	BONE HAND DRILLS RALK.....	300	BONNEY SURGICAL TISSUE FORCEPS.....	88
BIOPSY FORCEPS TOWNSEND MINI.....	591	BONE HAND DRILLSSTILLE.....	298	BOSE TRACHEA HOOK.....	476, 477
BIOPSY FORCEPS TOWNSEND TISCHLER MINI.....	591	BONE HAND DRILLSSTILLE-SHERMAN.....	298	BOUCHERON EAR SPECULA.....	399
BIOPSY FORCEPS VAN DOREN.....	588	BONE HOLDING CLAMP FELDHEIM.....	249	BOWEL CLAMP BABY-KOCHER.....	540
BIOPSY FORCEPS WITNER.....	589	BONE HOLDING CLAMP GERSTER.....	250	BOWEL CLAMP BRUNNER.....	543
BIOPSY FORCEPSTISCHLER-MORGAN.....	590	BONE HOLDING CLAMP LAMBERT-LOWMAN.....	249	BOWEL CLAMP DOYEN.....	540
BIOPSY NEEDLE MENGHINI.....	206	BONE HOLDING CLAMP LOWMAN.....	249	BOWEL CLAMP FEHLAND.....	542
BIOPSY NEEDLEFRANKLIN-SILVERMANN.....	206	BONE HOLDING CLAMP LOWMAN-HOGLUND.....	249	BOWEL CLAMP KOCHER.....	540
BIOPSY-/SUCTION CURETTE.....	600	BONE HOLDING FORCEPS.....	249	BOWEL CLAMP MAYO-ROBSON.....	541



BOWEL CLAMP PAYR .....	548	BRUNNER RIB SCISSORS .....	481	CATARACT KNIVES DEUTSCHMANN .....	371
BOWEL CLAMP RESANO .....	542	BRUNS BANDAGE SCISSORS .....	70	CATARACT KNIVES GRAEFE .....	371
BOWEL CLAMP SCUDDER .....	541	BRUNS BONE CURETTES .....	251, 254	CATARACT LOOP ARLT .....	378
BOWEL CLAMPSTONE-WATT .....	545	BRUSH DISPENCOR .....	611	CATARACT LOOP SNELLEN .....	378
BOWEL GRASPING FORCEPS ALLIS .....	537	BRYANT DRESSINGFORCEPS .....	137	CATARACT LOOP WEBER .....	378
BOWEL GRASPING FORCEPS ALLIS-ADAIR .....	537	BUCHWALD TONGUE DEPRESSORS .....	451	CATARACT LOOP WILDER .....	378
BOWEL GRASPING FORCEPS ALLIS-BABY .....	537	BUCK EAR CURETTE .....	407	CATHETER INTRODUCING FORCEPS MAGILL .....	28
BOWEL GRASPING FORCEPS ATRAUMA .....	111	BUCK FOREIGN-BODY LEVER .....	412	CATHETER FORCEPS COOLEY .....	510
BOWEL GRASPING FORCEPS BABCOCK .....	539	BUCK PERCUSSION HAMMER .....	24	CATHETER GUIDE GUYON .....	554
BOWEL GRASPING FORCEPS COLLIN .....	539	BUCK-GRAMCKO BONE LEVERS .....	285	CATLIN AMPUTATION KNIVES .....	44
BOWEL GRASPING FORCEPS DOYEN-BABY .....	540	BUCK-GRAMCKO BONE LEVERS .....	285	CAUTER WADSWORTH-TODD .....	378
BOWEL GRASPING FORCEPS DUVAL .....	539	BUIE RECTAL ABSUCTION TUBE .....	566	CERVICAL TRACTION TONG CRUTCHFIELD .....	327
BOWEL GRASPING FORCEPS JUDD-ALLIS .....	538	BULLDOG CLAMP ATRAUMA .....	100	CHALAZIO CURETTE AXENFELD .....	377
BOWEL GRASPING FORCEPS LITTLEWOOD .....	538	BULLDOG CLAMP DEBAKEY .....	100, 103	CHALAZIO CURETTE HEBRA .....	377
BOWEL GRASPING FORCEPS LOCKWOOD-ALLIS .....	538	BULLDOG CLAMP DIETRICH .....	101	CHALAZIO CURETTE MEYHOEFER .....	377
BOWEL GRASPING FORCEPS THOMS-ALLIS .....	538	BULLDOG CLAMP GLOVER .....	103	CHALAZIO TISSUE FORCEPS AVER .....	393
BOWEL GRASPING FORCEPS WILLIAMS .....	539	BULLDOG CLAMP JOHNS-HOPKINS .....	104	CHALAZIO TISSUE FORCEPS DESMARRES .....	393
BOWEL SPATULA HABERER .....	143/1	BULOW-GUNAR-HEY TUBINGCLAMP .....	130	CHALAZIO TISSUE FORCEPS LAMBERT .....	393
BOWEL SPATULA LERICHE .....	143/2	BUMM UTERINE CURETTE .....	597	CHAPUT TISSUE GRASPING FORCEPS .....	110
BOWEL SPATULA REVERDIN .....	143/1	BUNELL BONE HAND DRILLS .....	299	CHARNLEY ABDOMINALRETRACTORS .....	289
BOWEL SPATULA RIBBON .....	143	BUNELL TENDON GUIDE .....	294	CHARRIERE AMPUTATION SAW .....	296
BOWMAN DISCISION KNIVES .....	372	BUNELL TENDON PASSING INSTR. .....	292	CHEATLE STERILIZATION FORCEPS .....	227
BOWMAN DISCISION NEEDLE GERADE .....	374	BUNGE EXENTERATIONS .....	378	CHEEK RETRACTORSTERNBERG .....	453
BOWMAN EYE SPECULA .....	370	BUNT STERILIZATION CLAMP .....	227	CHEEKSTEIN NEEDLE HOLDER .....	210
BOWMAN LACHRYMAL PROBES .....	381	BURCH FIXATION FORCEPS .....	373	CHELSEA-EATON PROCTOSCOPE .....	563
BOX PETRI .....	620	BURKE BIOPSY FORCEPS .....	590	CHERON DRESSINGFORCEPS .....	137
BOYNTON NEEDLE HOLDER .....	214	BUSCH EPISIOTOMY SCISSORS .....	64	CHERRY LAMINECTOMY RETRACTOR .....	488
BOZEMANN DRESSINGFORCEPS .....	138	BUSHE BONE CURETTE .....	256	CHEST SUPPORT KLEINSASSER .....	36
BOZEMANN NEEDLE HOLDER .....	211	BUTTONPROBES JACOBSON .....	335	CHEVALIER-JACKSON .....	473
BOZEMANN-DOUGLAS DRESSINGFORCEPS .....	138			CHEVALIER-JACKSON TRACHEA CANNULA .....	479
BRAIN KNIVES .....	48			CHILDE CLIP FORCEPS .....	224
BRAIN SPATULA DAVIS .....	337	C		CHILDREN ATRAUMA VASCULAR CLAMP .....	526
BRAINSPATULA CUSHING .....	336	CABLE BIPOLAR .....	633	CHISEL NEVERT-ANDERSON .....	464
BRAINSPATULA CUSHING .....	369	CALIPER TOWNLEY .....	26	CHISELS .....	259, 262
BRAINSPATULA HEIFETZ .....	369	CALIPERS .....	26	CHISELS ALEXANDER .....	259
BRAINSPATULA OLIVECRONA .....	336	CANFIELD TONSIL-KNIVES .....	466	CHISELS BRUNETTI .....	268
BRAND TENDON GRASPING INSTRUMENT .....	293	CANNULA .....	406	CHISELS COTTLE .....	440
BRAND TENDON PASSING INSTR. .....	294	CAPLAN NOSE FORCEPS .....	428	CHISELS HIBBS .....	265
BRAUN CRANIPLAST .....	607	CAPSULA SCISSORS RESANO .....	53/2	CHISELS HOKE .....	265
BRAUN DECAPITATING HOOK .....	607	CAPSULAR FORCEPS ARRUGA .....	391	CHISELS KILLIAN .....	442/1
BRAUN HOOK FORCEPS .....	582	CAPSULAR FORCEPS CASTROVIEJO .....	391	CHISELS LAMBOTTE .....	261
BRAUN UTERINE-DEPRESSOR .....	586	CAPSULAR FORCEPS ELSCHNIG .....	391	CHISELS LEXER .....	263
BRAUN-STADLER EPISIOTOMY SCISSORS .....	64	CAPSULAR FORCEPS FUCHS .....	391	CHISELS MINI-LAMBOTTE .....	262
BREAST RETRACTOR .....	198	CAPSULAR FORCEPS GILL-ARRUGA .....	390	CHISELS NOVOTEX .....	264
BREISKY VAGINAL SPECULA .....	577	CAPSULAR FORCEPS HESS .....	391	CHISELS OBWEGESER .....	463
BREITEN-MEASURING INSTRUMENT .....	594	CAPSULAR FORCEPS KALT .....	391	CHISELS SMITH-PETERSEN .....	261
BRIDGE HEMOSTATIC CLAMP .....	116	CAPSULAR FORCEPS SCHWEIGGER .....	391	CHISELSBLADE .....	266
BRISTOW BONE LEVERS .....	290	CAPSULAR FORCEPS TERSON .....	391	CHISELSSTILLE .....	260
BRISTOW BONE LEVERS .....	290	CAPSULAR GRASPING FORCEPS MILLIN .....	551	CILIA FORCEPS BARRAQUER .....	395
BRODIE PROBES .....	199	CARDIOVASCULAER CLAMP .....	526	CILIA FORCEPS BEER .....	395
BRONCHO.FORCEPS CHEVALIER-JACK .....	473	CARMALT SPLINTER TISSUE FORCEPS .....	91	CILIA FORCEPS DOUGLAS .....	395
BRONCHUS CLAMP .....	126	CAROLL TENDON GRASPING INSTRUMENT .....	293	CILIA FORCEPS GRADLE .....	395
BRONCHUSCLAMP FINOCCHIETTO .....	490	CARPENTIS-SHUNT CLAMP JAVID .....	511	CILIA FORCEPS LITTAUER .....	395
BRONCHUSCLAMP HARRINGTON .....	490	CARPENTER TONSIL KNIVES .....	465	CILIA FORCEPS REDA .....	395
BRONCHUSCLAMP LEES .....	504	CARTILAGE KNIVES .....	47	CINELLI SEPTUM CHISELS .....	441
BRONCHUSCLAMP PRICE-THOMAS .....	490	CASPAR HEMOSTATS .....	258	CIRCULAR RONGEUR .....	432
BRONCHUSCLAMP SEMB .....	491	CASPAR RETRACTORS .....	179, 180	CIRCUMCISIONS INSTRUMENT .....	556
BROPHY ANATOMIC TISSUE FORCEPS .....	84	CASTANEDA NEONATAL VASCULAR CLAMP .....	527	CITELLI RONGEUR .....	430
BROPHY SURGICAL TISSUE FORCEPS .....	84	CASTROVIEJO PROBE .....	381	CLAMP VASEKTOMIE .....	553/2
BROWN NEEDLE HOLDER .....	209	CASTROVIEJO BLADEBREAKER .....	45	CLAMPHOLDING .....	326
BROWN TISSUE FORCEPS .....	83	CASTROVIEJO CAPSULAR FORCEPS .....	391	CLAR HEAD LIGHTS .....	22
BRUENINGS .....	468, 472	CASTROVIEJO CYCLODIALYSIS SPATULA .....	379	CLARK EYE SPECULA .....	370
BRUENINGS EAR SPECULA .....	401	CASTROVIEJO DISCISION KNIVES .....	372	CLAUS TONSIL NEEDLE .....	466
BRUENINGS INTERCHANGEABLE TIPS .....	472	CASTROVIEJO EYE SPECULA .....	371	CLAYMAN .....	376
BRUENINGS SEPTUM FORCEPS .....	425	CASTROVIEJO FIXATION FORCEPS .....	390	CLAYMAN HOOK .....	376
BRUENINGS TONGUE DEPRESSORS .....	451	CASTROVIEJO HORNYSKINSCISSORS .....	79	CLEANING PISTOL .....	626
BRUENINGS TONSIL-KNIVES .....	466	CASTROVIEJO MEASURANCE CIRCLE .....	380	CLEVELAND BONE RONGEUR .....	235
BRUNETTI CHISELS .....	268	CASTROVIEJO NEEDLE HOLDER .....	215	CLIP FORCEPS CHILDE .....	224
BRÜNINGS-LUCAS CHISELS .....	260	CASTROVIEJO TISSUE FORCEPS .....	392	CLIP FORCEPS COLLIN .....	224
BRUNNER BOWEL CLAMP .....	543	CASTROVIEJO-MICRO NEEDLE HOLDER .....	215	CLIP FORCEPS MICHEL .....	224
BRUNNER GUIDEPROBES .....	221	CASTROVIEJO-STANDARD NEEDLE HOLDER .....	216	CLIP FORCEPSRICHTER-HEATH .....	224
BRUNNER GUIDEPROBES .....	221	CATARACT CURETTE DAVIEL .....	377	CLIP MICHEL .....	224
BRUNNER RETRACTOR .....	167	CATARACT CURETTE GRAEFE .....	377	CLIP TISSUE FORCEPS HEGENBARTH .....	224
		CATARACT CURETTE KNAPP .....	378		

CLIP TISSUE FORCEPS MICHEL.....	224	COTTLE FIXATION FORCEPS.....	410	D	
CLIP TISSUE FORCEPS WACHENFELDT.....	224	COTTLE HAMMER.....	273	DANDY HEMOSTATIC CLAMP.....	109
CLIP-APPLIER FORCEPS.....	523, 524	COTTLE NOSE HOOK.....	447, 447/1	DANDY NERVE HOOK.....	328
CLOWARD LAMINA SPREADER.....	339	COTTLE NOSE SCISSORS.....	59	DARLING RETRACTORS.....	178
CLOWARD LAMINECTOMY RETRACTOR FORCEPS.....	342	COTTLE NOSE SPECULA.....	423	DARTIGUES UTERINE-GRASPING FORCEPS.....	585
CLOWARD RETRACTORS.....	178	COTTLE SCISSORS.....	56	DASTOOR STRABISMUS FORCEPS.....	386
COAKLEY ANTRUM CURETTE.....	449	COTTLE SEPTUM CHISELS.....	440	DASTOOR SUCTION TUBE.....	380
COAKLEY TROCAR.....	204	COTTLE SEPTUM ELEVATOR.....	439	DAUBENSPECK BONE CURETTES.....	255
COBB CURETTE.....	252	COTTLE SEPTUM KNIVES.....	435	DAVIDSON(SCAPULA) RETRACTOR.....	166
COBB GOUGES.....	262	COTTLE SKIN HOOK.....	447, 448	DAVIEL CATARACT CURETTE.....	377
COBB RASPATORIES.....	280	COTTLE-JOSEPH SEPTUM.....	439	DAVIS BRAIN SPATULA.....	337
COLCLOUGH INTERVERTEBRAL DISC RONGEUR.....	344/1	COTTLE-KAZANJIAN BONE CUTTING FORCEPS.....	241	DAVIS DURA DISSECTOR.....	379
COLD LIGHT GUIDE HOLLINGER.....	37	COTTLE-NEIVERT.....	448	DAVIS FOREIGN-BODY NEEDLE.....	374
COLD LIGHT GUIDE JACKSON.....	37	COTTON-APPLICATOR.....	230	DAVIS STERILIZATION TISSUE FORCEPS.....	227
COLD LIGHT CLAMP FOR AMNOSKOPE.....	601	COTTON-APPLICATOR FARRELL.....	203	DAVIS-BOYLE.....	455
COLLER-CRILE HEMOSTATIC CLAMP.....	106	COTTON-APPLICATOR JOBSON-HORNBYE.....	203	DAVIS-BOYLE SPERRE.....	455
COLLIER NEEDLE HOLDER.....	208	COTTON-APPLICATOR REDA.....	203	DAVIS-MEYER MOUTH GAG.....	457
COLLIER PELVIMETER.....	605	COTTON-APPLICATOR TEBOLD.....	203	DAY HOOK.....	409
COLLIN ABDOMINAL RETRACTORS.....	190	COTTON-APPLICATOR UCKERMANN.....	203	DE BAKEY NEEDLE HOLDER.....	210
COLLIN BOWEL GRASPING FORCEPS.....	539	COXETER METAL CATHETER.....	555	DE BAKEY VASCULAR CLAMP.....	494
COLLIN CLIP FORCEPS.....	224	CRAFOOD-SELLORS HEMOSTATIC CLAMP.....	118	DE BAKEY VASCULAR CLAMP.....	495
COLLIN DRESSING FORCEPS.....	137	CRAFOOD HEMOSTATIC CLAMP.....	118	DE BAKEY VASCULAR SCISSORS.....	60, 61
COLLIN DYNAMOMETER.....	25	CRAFOOD LUNG SCISSORS.....	65/2	DE BAKEY VASCULAR-DILATOR.....	529
COLLIN HAMMER.....	270	CRANIPLAST BRAUN.....	607	DE BOER RIB SPREADER.....	486
COLLIN LOKTITE ABDOMINALDE.....	191	CRANIPLAST TARNIER.....	607	DE LEE OBSTETRICAL FORCEPS.....	602
COLLIN NAVELSTRING CLAMP.....	605	CREGO ELEVATOR.....	282	DE MARTEL GUIDE SLEEVE.....	330
COLLIN PELVIMETER.....	605	CRILE HEMOSTATIC CLAMP.....	107	DE MARTEL-WOLFSON.....	546
COLLIN RETRACTOR.....	139	CRILE NEEDLE HOLDER.....	213	DEAN IRIS KNIVES.....	372
COLLIN SCALPEL-HANDLE.....	40	CRILE NERVE HOOK.....	328	DEAN TONSIL SCISSORS.....	59
COLLIN TISSUE GRASPING FORCEPS.....	110	CRILE RETRACTOR.....	140	DEAVER DISSECTING SCISSORS.....	52
COLLIN TONGUE FORCEPS.....	453	CRILE-MURRAY NEEDLE HOLDER.....	209	DEAVER RETRACTOR.....	145
COLLIN UTERINE-GRASPING FORCEPS.....	585	CRILE-RANKIN HEMOSTATIC CLAMP.....	107	DEAVER-GRIP RETRACTOR.....	146
COLLIN UTERINE-PROBES.....	586	CRILE-WOOD NEEDLE HOLDER.....	209	DEBAKEY AORTIC-ANAST.CLAMP.....	505
COLLIN VAGINAL SPECULA.....	570	CRITCHETT EYE SPECULA.....	370	DEBAKEY ATRAUMA BULLDOG CLAMP.....	100, 103
COLLIN-DUVAL GRASPING PINZE.....	85	CROWN SCISSORS BEEBEE.....	68	DEBAKEY ATRAUMA CLAMP.....	100
COLLIN-HARTMANN RETRACTOR.....	141	CRUTCHFIELD HEAD HOLDER.....	327	DEBAKEY ATRAUMA CLAMP.....	103
COLUMELLA TISSUE FORCEPS COTTLE.....	448	CRUTCHFIELD CERVICAL TRACTION TONG.....	327	DEBAKEY ATRAUMATIC TISSUE FORCEPS.....	99
COLVER TONSIL FORCEPS.....	467	CUFF FOR LEG.....	295	DEBAKEY RETRACTOR.....	189/1
COMEDONE EXTRACTOR SAALFELD.....	608	CUFF FOR UPPER ARM.....	295	DEBAKEY SUCTION TUBE.....	28
COMEDONE EXTRACTOR SCHAMBERG.....	608	CULLER IRIS SPATULA.....	378	DEBAKEY VASCULAR CLAMP.....	507, 514, 515, 516
COMEDONE EXTRACTOR UNNA.....	608	CUP MEDICINE.....	621	DEBAKEY VASCULAR SCISSORS.....	61
COMEDONE EXTRACTOR WALTON.....	608	CUP SPUTUM.....	621	DEBAKEY VASCULAR SCISSORS TC.....	60
COMPRESSION BANDAGE.....	296	CURETTE ANTRUM.....	435	DEBAKEY-BAHNSON ANEURYSM CLAMP.....	506
CONE CURETTE.....	280	CURETTE COBB.....	252	DEBAKEY-DIETHRICH MINI BULLDOG CLAMP.....	101
CONE HEAD PUNCH.....	331	CURETTE FAULKNER.....	449	DEBAKEY-MOSQUITO HEMOSTATIC CLAMP.....	509
CONE RASPATORIES.....	280	CURETTE FORCEPS.....	416	DEBAKEY-PEAN ATRAUMA CLAMP.....	513
CONNIN-AMSLER MARKERS.....	380	CURETTE HOUSE.....	420	DEBAKEY-RANKIN ATRAUMA CLAMP.....	512
CONVERSE NOSE HOOK.....	448	CUSCO VAGINAL SPECULA.....	570	DECAPITATING HOOK BRAUN.....	607
CONVERSE SEPTUM KNIVES.....	435	CUSHING (TAYLOR) TISSUE FORCEPS TC.....	87	DEJERINE PERCUSSION HAMMER.....	24
COOLEY ANASTOMOSIS CLAMP.....	519, 520	CUSHING ANATOMIC TISSUE FORCEPS.....	83	DELEE RETRACTOR.....	574
COOLEY AORTIC DILATOR.....	528	CUSHING BRAIN SPATULA.....	336, 369	DEMEL WIRE GUIDE NEEDLE.....	315
COOLEY CATHETER FORCEPS.....	510	CUSHING DRILL.....	299	DEMEL WIRE INSTRUMENT.....	315
COOLEY RETRACTOR.....	148	CUSHING LAMINECTOMY RETRACTOR FORCEPS.....	340	DENHART MOUTH GAGS.....	454
COOLEY RIB SPREADER.....	487	CUSHING NERVE ENHOOK.....	328	DENIS-BROWNE ABDOMINAL RETRACTORS.....	186
COOLEY VASCULAR CLAMP.....	518, 522	CUSHING RETRACTOR.....	152	DERF NEEDLE HOLDER.....	208
COOLEY-DERRA ANASTOMOSIS CLAMP.....	519	CUSHING RETRACTOR.....	153	DERMATOM HUMBY.....	50
COOLEY-NEONATAL RIB SPREADER.....	485	CUSHING RETRACTOR.....	151, 152, 153	DERMATOM SILVER.....	50
COOLY SUCTION TUBE.....	28	CUSHING SURGICAL TISSUE FORCEPS.....	83	DERMATOME SCHINK.....	49
COOPER LIGATUREE NEEDLE.....	219	CUSHING TISSUE FORCEPS.....	87	DERMATOME BLADE.....	49
CORDES INTERCHANGEABLE TIPS.....	472	CUSHING-TAYLOR ANATOMIC TISSUE FORCEPS.....	87	DESCHAMPS LIGATUREE NEEDLE.....	218
CORNEAL DISSECTOR GREEN.....	374	CUZZI OVUM CURETTE.....	606	DESJARDINS GALL STONE.....	532
CORNEAL DISSECTOR PATON.....	373	CYCLODIALYSIS SPATULA BANGERTER.....	379	DESJARDINS GALL STONE CURETTE.....	534
CORNEAL SCARIFIER ELSCHNIG.....	373	CYCLODIALYSIS SPATULA CASTROVIEJO.....	379	DESJARDINS GALL STONE FORCEPS.....	531
CORNEAL SCARIFIER GILL.....	373	CYCLODIALYSIS SPATULA ELSCHNIG.....	379	DESJARDINS HEMOSTATIC CLAMP.....	121
CORNEAL SCARIFIER SATO.....	373	CYCLODIALYSIS SPATULA WHEELER.....	379	DESMARRES CHALAZIO TISSUE FORCEPS.....	393
CORNEAL SCARIFIER TOOK.....	373	CYSTOTOM BECKER.....	375	DESMARRES RETRACTOR.....	151
CORNEAL SCLEROTOME KUHN.....	373	CYSTOTOM GRAEFE.....	375	DEUTSCHMANN CATARACT KNIVES.....	371
CORONAL BROW RETRACTOR.....	198	CZERNY HOOK FORCEPS.....	584	DEVILBISS HEAD FORCEPS.....	332
CORWIN-HEGAR WIRE FORCEPS.....	319	CZERNY RECTAL-SPECULA.....	559	DIAGNOSTIC SET ECO "C".....	16
CORYLLOS RETRACTOR.....	166			DIAGNOSTIC SET ECO "T".....	16
CORYLLOS RIB SCISSORS.....	480			DIAGNOSTIC SET RI-MINI.....	17
COS MICRO-EAR FORCEPS.....	414			DIAGNOSTIC SET UNI III.....	15
COTTLE COLUMELLA TISSUE FORCEPS.....	448			DIFFENBACH VASCULAR CLAMP.....	104



DIETER MICRO-EAR FORCEPS.....414	DRESSINGFORCEPS FOERSTER.....136	EARSYRINGE REINER.....406
DIETRICH BLOOD VESSEL CLAMP.....510	DRESSINGFORCEPS GROSS-MAIER.....134	ECHLIN BONE RONGEUR.....240
DIETRICH MINI-BULLDOG CLAMP.....101	DRESSINGFORCEPS LISTER (SINUS).....137	ECO "C" DIAGNOSTIC SET.....16
DIETRICH VASCULAR SCISSORS.....60	DRESSINGFORCEPS M.SPERRE.....135	ECO "T" DIAGNOSTIC SET.....16
DILATION BOUGIE DITTEL.....554	DRESSINGFORCEPS MAIER.....134	EICKEN (KILLIAN) IRRIGATION CANNULA.....433
DILATION BOUGIE GUYON.....554	DRESSINGFORCEPS PELKMANN.....137	ELEVATOR ALDERDYCE.....282
DILATION BOUGIE VAN BUREN.....554	DRESSINGFORCEPS RAMPLEY.....136	ELEVATOR BOIES.....277
DINGMANN BONE HOLDING FORCEPS.....246	DRESSINGFORCEPS SIMS-MAIER.....134	ELEVATOR CREGO.....282
DINGMANN MOUTH GAGS.....456	DRESSINGFORCEPS ULRICH.....135	ELEVATOR DINGMANN.....463, 463/3
DINGMANN RASPARTORIES.....463	DRESSINGTISSUE FORCEPS JACKSON.....471	ELEVATOR KEY.....282
DINGMANN RETRACTOR.....463	DRILL.....299	ELEVATOR LEMPERT.....420
DINGMANN SPREADER.....456	DRILL BITS.....302	ELEVATOR LUNIATSCHEK.....465
DIPLOMAT SPHYGMOMANOMETER.....5	DRILL CUSHING.....299	ELEVATOR MCDONALD.....283
DISCISION KNIVES BERENS.....372	DRILL ERRICO.....299	ELEVATOR MURPHY-LANE.....283
DISCISION KNIVES BOWMAN.....372	DRILL MC KENZIE.....299	ELEVATOR SAYRE.....281
DISCISION KNIVES CASTROVIEJO.....372	DRILL SUPPORT.....310	ELEVATOR WATSON-CHEVNE.....283
DISCISION KNIVES JAEGER.....372	DRILL WIRE.....299	ELEVATORIUM FREER.....434
DISCISION KNIVES WHEELER.....373	DRILLWIRE KIRSCHNER.....306, 307	ELLIOT OBSTETRICAL FORCEPS.....602
DISCISION KNIVES ZIEGLER.....373	DRIVER KUENTSCHER.....321	ELJIS FOREIGN-BODY GOUGES.....374
DISCISION NEEDLE.....374	DRIVERS.....321	ELSCHING CAPSULAR FORCEPS.....391
DISCISION NEEDLE BOWMAN.....374	DUBOIS GYNECOLOGICAL SCISSORS.....63	ELSCHING CORNEAL SCARIFIER.....373
DISSECTING SCISSORS.....52	DUEHRSEN ANATOMIC TISSUE FORCEPS.....84	ELSCHING CYCLODIALYSIS SPATULA.....379
DISSECTING SCISSORS.....53/2	DUPLAY DRESSINGFORCEPS.....134	ELSCHING FIXATION FORCEPS.....389
DISSECTING SCISSORS DEAVER.....52	DUPLAY HOOK FORCEPS.....582	EMMETT FISTULA HOOK.....594
DISSECTING SCISSORS JORGENSEN.....53	DUPLIX STETHOSCOPE.....23	ENDERNAIL STEINMANN.....307
DISSECTING SCISSORS LEXER.....53	DUPUY-WEISS TONSIL KNIVES.....466	ENDOSCOPE ASSEMBLY.....188
DISSECTING SCISSORS LEXER-BABY.....53	DURA DISSECTOR.....332	ENDOSCOPE WIREBASKET.....623
DISSECTING SCISSORS LEXER-BABY TC.....53	DURA DISSECTOR DAVIS.....332	ENDOSPECULA KOGAN.....577
DISSECTING SCISSORS MAYO.....52	DURA DISSECTOR FRAZIER.....333	ENGEL PLASTER CAST SAW.....229
DISSECTING SCISSORS MAYO TC.....52	DURA DISSECTOR HOEN.....333	ENTEROTOMY SCISSORS.....66
DISSECTING SCISSORS MAYO-NOBLE.....52	DURA DISSECTOR HORSLEY.....333	ENTROPION FORCEPS SNELLEN.....393
DISSECTING SCISSORS MAYO-STILLE.....52	DURA DISSECTOR MILLIGAN.....332	ENUCLATION CURETTE WELLS.....378
DISSECTING SCISSORS MAYO-STILLE.....52	DURA DISSECTOR OLIVECRONA.....332	ENUCLEATION SCISSORS.....58
DISSECTING SCISSORS MAYO-STILLE TC.....52	DURA DISSECTOR SACHS.....332	EPIGLOTTIS RETRACTOR FRAENKEL.....471
DISSECTING SCISSORS METZENBAUM.....53/1	DURA DISSECTOR TOENNIS.....332	EPIGLOTTIS RETRACTOR JACKSON.....471
DISSECTING SCISSORS METZENBAUM.....53/1	DURA DISSECTOR WOODSON.....333	EPIGLOTTIS RETRACTOR REICHERT.....471
DISSECTING SCISSORS METZENBAUM FINO.....53/1	DURA HOOK.....335	EPISTOMY SCISSORS WALDMANN.....64
DISSECTING SCISSORS METZENBAUM TC.....53/1	DURA HOOK JACOBSON.....335	EPKER OSTEOTOME.....464/2
DISSECTING SCISSORS PECK-JOSEPH.....74	DURA KNIVES KOOS.....335	EPPENDORFER BIOPSY FORCEPS.....590
DISSECTING SCISSORS TOENNIS-ADSON.....65	DURAHOOK ADSON.....328	ESMARCH BANDAGE SCISSORS.....69/2
DISSECTING SCISSORS METZENBAUM FINO TC.....53/1	DURANTE GRASPING TISSUE FORCEPS.....88	ESMARCH PLASTER KNIVES.....233
DISSECTOR FISCH.....420	DURASSCISSORS SCHMIEDEN-TAYLOR.....65/1	ETHICON CLIP FORCEPS.....524
DISSECTOR GORNEY.....277	DUVAL BOWEL GRASPING FORCEPS.....539	EVES TONSIL SNARE.....468
DISSECTOR PENFIELD.....333	DUVAL GRASPING TISSUE FORCEPS.....85	EXACTA SPHYGMOMANOMETER.....8
DITTEL DILATION BOUGIE.....554	DYNAMOMETER COLLIN.....25	EXENTERATION CURETTE BUNGE.....378
DIX FOREIGN-BODY CHISELS.....374	E	EXTENSIONS BOWS BOEHLER.....312
DIX FOREIGN-BODY INSTRUMENT.....380	EAR CATHETER HARTMANN.....408	EXTENSIONS BOWS KIRSCHNER.....312
DOUBLECURETTE VOLKMAN.....257	EAR CURETTE BUCK.....407	EXTENSIONS BOWS KIRSCHNER US.....312
DOUGHTY TONGUE BLADE.....458	EAR CURETTE GROSS.....409	EXTIRPATIONSCHEISLS ROLLET.....374
DOUGLAS CILIA FORCEPS.....395	EAR FORCEPS HARTMANN.....411	EXTRACTION DISSECTOR LANG.....378
DOUGLAS TONSIL KNIVES.....466	EAR FORCEPS HEYMANN-KNIGHT.....425	EXTRACTION HOOK.....322
DOUGLAS TROCAR.....205	EAR FORCEPS JANSEN.....424	EXTRACTION HOOK KNAPP.....375
DOYEN ABDOMINALRETRACTORS.....189/1	EAR FORCEPS JANTZEN.....424	EXTRACTION HOOK ROLLET.....375
DOYEN BOWEL CLAMP.....540	EAR FORCEPS LITTAUER.....411	EXTRACTION HOOK ARRUGA.....375
DOYEN GYNECOLOGICAL SCISSORS.....63	EAR FORCEPS LUCAE.....410	EXTRAKTOR KUENTSCHER.....322
DOYEN MYOMA A SCREW.....594	EAR FORCEPS TILLEY.....411	EYE CANNULA MCINTYRE.....394
DOYEN PROBES.....199	EAR FORCEPS TROELTSCH.....424	EYE CANNULA TYPE AIR INJECTION.....394
DOYEN RASPARTORIES.....278	EAR FORCEPS WILDE (TROELTSCH).....410	EYE CANNULA TYPE SHEETS.....394/2
DOYEN RETRACTOR.....163	EAR KNIVES POLITZER.....408	EYE MAGNET REDA.....395
DOYEN SCISSORS.....63	EAR KNIVES SEXTON.....408	EYE SPECULA ARRUGA.....370
DOYEN TOWEL CLAMP.....133	EAR LEVER ZAUFAL.....409	EYE SPECULA BARRAQUER.....370
DOYEN UTERINE POLYP FORCEPS.....585	EAR LEVER ZAUFAL-JANSEN.....409	EYE SPECULA BOWMAN.....370
DOYEN VAGINAL SPECULA.....574	EAR LOOP BILLEAU.....409	EYE SPECULA CASTROVIEJO.....371
DOYEN-BABY BOWEL CLAMP.....540	EAR LOOP SHAPLEIGH.....410	EYE SPECULA CLARK.....370
DOYEN-JANSEN(MOLT).....454	EAR SPECULA BOUCHERON.....399	EYE SPECULA CRITCHETT.....370
DOYEN-JANSEN(MOLT) MOUTH GAGS.....454	EAR SPECULA BRUENINGS.....401	EYE SPECULA GRAEFE.....370
DOYEN-STILLE REPRATOR.....167	EAR SPECULA GRUBER.....399	EYE SPECULA LANCASTER.....371
DRESSINGFORCEPS.....135	EAR SPECULA HARTMANN.....399	EYE SPECULA LISTER-BURCH.....370
DRESSINGFORCEPS BOZEMANN.....138	EAR SPECULA POLITZER.....399	EYE SPECULA MELLINGER.....370
DRESSINGFORCEPS BOZEMANN-DOUGLAS.....138	EAR SPECULA RICHNAU-HOLMGREN.....400	EYE SPECULA MELLINGER-AXENFELD.....370
DRESSINGFORCEPS BRYANT.....137	EAR SPECULA SIEGLE.....402	EYE SPECULA MUELLER.....371
DRESSINGFORCEPS CHERON.....137	EAR SPECULA TOYNBEE.....399	EYE SPECULA MURDOCK.....370
DRESSINGFORCEPS COLLIN.....137	EARPROBESSTACKE.....199	EYE SPECULA PARK.....371



EYE SPECULA SMITH .....	370	FIXATION FORCEPS LESTER .....	389	GASS HOOK .....	376
EYE SPECULA WEEK .....	370	FIXIERFORC BURCH .....	373	GAUSS KOPFSCHWARTE.....	605
EYE SPECULA WILLIAMS .....	370	FIXIERVORRICHTUNG ROCHARD .....	186	GELPI ABDOMINALRETRACTORS .....	189/1, 189/2
EYE SPECULA ZIEGLER.....	371	FLAT FORCEPS .....	316, 317	GELPI HOOK .....	193
EYE SPECULAST.EVENSEN.....	371	FOERSTER DRESSINGFORCEPS .....	136	GEMINI HEMOSTATIC CLAMP .....	115
EYE SUCTION -IRRIGATION CANNULA .....	394	FOERSTER IRIS TISSUE FORCEPS .....	383	GERALD ANATOMIC TISSUE FORCEPS .....	86
EYESCISSORS BARRAQUER.....	75	FOMON NOSE RASP .....	444	GERALD SURGICAL TISSUE FORCEPS .....	87
EYESCISSORS NOYES.....	75	FOMON NOSE SCISSORS .....	58	GERSTER BONE HOLDING CLAMP .....	250
EYESCISSORS VANNAS .....	79	FOMON RASPTORIES .....	277	GERZOG HAMMER .....	270
EYESCISSORS WECKER.....	75	FOMON RHINOPLASTSCISSORS.....	65/1	GERTZ-STILLE RIB SCISSORS .....	481
EYESCISSORS WESTCOTT .....	75	FOMON SEPTUM CHISELS .....	441	GIGLI SAW .....	332
<b>F</b>		FOMON SKIN HOOK .....	447/1	GILL CORNEAL SCARIFIER .....	373
FACE LIFT SCISSORS FREEMAN .....	74	FOMON TC NOSE RASP .....	445	GILL IRIS TISSUE FORCEPS.....	384
FACE LIFT SCISSORS GORNEY .....	73	FOREGGER LARYNGOSCOPI .....	29, 31	GILL-ARRUGA CAPSULAR FORCEPS .....	390
FACE LIFT SCISSORS KAYE .....	73	FOREIGN-BODY CHISELS DIX .....	374	GILL-HESS IRIS TISSUE FORCEPS .....	384
FACE LIFT SCISSORS REES .....	73	FOREIGN-BODY CURETTE ALVIS .....	374	GILLIES NEEDLE HOLDER .....	212
FANSLER PROCTOSCOPE .....	564	FOREIGN-BODY FORCEPS HARTMANN .....	412	GILLIES SKIN HOOK.....	448
FARABEUF BONE HOLDING FORCEPS .....	243	FOREIGN-BODY FORCEPS HARTMANN-HOFFMANN.....	412	GILLIES SURGICAL TISSUE FORCEPS .....	86
FARABEUF RASPTORIESIES .....	274	FOREIGN-BODY FORCEPS HARTMANN-WULLSTEIN.....	412	GIL-VERNET RETRACTOR .....	152
FARABEUF RETRACTOR .....	139	FOREIGN-BODY FORCEPS MATHIEU .....	553/1	GLOVER ATRAUMA CLAMP .....	100
FARABEUF-COLLIN RASPTORIESIES .....	274	FOREIGN-BODY GOUGES ELLIS .....	374	GLOVER BULLDOG CLAMP .....	103
FARABEUF-LAMBOTTE BONE HOLDING FORCEPS .....	243	FOREIGN-BODY GOUGES WALTON .....	374	GLOVER VASCULAR CLAMP .....	515
FARRELL COTTON-APPLICATOR .....	203	FOREIGN-BODY INSTR. DIX .....	380	GLUCK RIB SCISSORS .....	480
FARRIOR EAR SPECULA .....	400	FOREIGN-BODY LEVER BUCK .....	412	GOELET RETRACTOR .....	141
FARRIOR EAR SPECULA .....	400	FOREIGN-BODY LEVER QUIRE .....	412	GOLDMANN-FOX GUMSCISSORS .....	67
FAULKNER CURETTE .....	449	FOREIGN-BODY NEEDLE .....	374	GOMEL MICROSURGICAL TISSUE FORCEPS.....	96
FAURE BIOPSY FORCEPS .....	588	FOREIGN-BODY NEEDLE DAVIS .....	374	GOMMEL MICRO-SCISSORS .....	80
FAURE PERITONEUMCLAMP .....	123	FOREIGN-BODY NEEDLE FRANCIS .....	374	GONIOMETER F. FINGER.....	25
FAVALORO VASCULAR SCISSORS .....	61	FOREIGN-BODY NEEDLE LA FORCE .....	374	GONIOMETER MOELTGEN .....	25
FEHLAND BOWEL CLAMP .....	542	FOREIGN-BODY NEEDLE LEVINSON .....	374	GONIOTOMY KNIVES BARKAN .....	373
FEILCHENFELD TISSUE FORCEPS .....	91	FOX LUPUS CURETTE .....	608	GONIOTOMY KNIVES SCHEIE .....	373
FELDHEIM BONE HOLDING CLAMP .....	249	FRAENKEL INTERCHANGEABLE TIPS .....	472	GOOD TONSIL SCISSORS .....	59
FERGUSSON BONE HOLDING FORCEPS .....	243	FRANCIS FOREIGN-BODY NEEDLE .....	374	GOODELL UTERINE DILATATOR .....	581
FERGUSSON FRAZIER SUCTION TUBE .....	337	FRANKLIN-SILVERMANN BIOPSY NEEDLE .....	206	GORNEY DISSECTOR .....	277
FERGUSSON GALL STONE CURETTE .....	533	FRAZIER ABDOMINALRETRACTORS .....	181	GORNEY FACE LIFT SCISSORS .....	73
FERGUSSON HAEMORRHOIDALCLAMP .....	109	FRAZIER DURA DISSECTOR.....	333	GOSSET ABDOMINALRETRACTORS .....	181
FERGUSSON SURGICAL SCISSORS .....	66	FRAZIER FUNCTION CANNULA .....	337	GOUGES .....	264
FERRIERA RETRACTOR .....	197	FRAZIER SKIN HOOK .....	149	GOUGES PARTSCH.....	259
FERRIS-SMITH LAMINECTOMY RETRACTOR FORCEPS .....	343	FREEMAN FACE LIFT SCISSORS .....	74	GOUGES COBB .....	262
FERRIS-SMITH SURGICAL TISSUE FORCEPS .....	85	FREEMAN RETRACTOR .....	198	GOUGES HIBBS .....	265
FERRIS-SMITH-KERRISON RONGEUR .....	344, 344/2	FREER ELEVATORIUM .....	434	GOUGES LEXER MINI .....	263
FIBERGLAS-LIGHT GUIDE KLEINSASSER .....	36	FREER SEPTUM CHISELS .....	439, 442	GOUGES WEST .....	442/1
FICHOCHIETTO-BABY RIB SPREADER .....	482	FREER SEPTUM ELEVATOR.....	437	GOUGES ZIELKE .....	264
FILES BONE .....	612/1	FREER SEPTUM KNIVES .....	434	GOUGESSTILLE .....	260
FINGER NAIL DRILL.....	297	FREER SKIN HOOK .....	448	GOUREDT UTERINE CURETTE .....	599
FINGER PROTECTOR LANGENBECK.....	311	FRENZEL NYSTAGMUS SPECTACLES .....	20	GRADLE CILIA FORCEPS .....	395
FINGER RING SAW REDA .....	297	FRENZEL TONGUE DEPRESSORS .....	451	GRADLE OPHTHALMOLOGIC SCISSORS .....	57
FINGER RING SAW WALTON .....	297	FRIEDMANN MINI BONE RONGEUR .....	234	GRADUATED MEASURE .....	620
FINGER-GONIOMETER .....	25	FRIEDMANN SPECULA .....	577	GRAEFFE CATARACT CURETTE .....	377
FINGERSAW LANGENBECK.....	296	FRITSCH RETRACTOR.....	163	GRAEFFE CATARACT KNIVES .....	371
FINOCCHIETTO BRONCHUSCLAMP .....	490	FRYKHOLM BONE RONGEUR .....	240	GRAEFFE CYSTOTOM .....	375
FINOCCHIETTO RIB SPREADER .....	482	FUCHS CAPSULAR FORCEPS.....	391	GRAEFFE DISCISION KNIVES .....	372
FINOCCHIETTO NEEDLE HOLDER .....	211	FUCHSIG HEMOSTATIC CLAMP .....	113	GRAEFFE DISCISION KNIVES .....	372
FINOCCHIETTO RIB SPREADER .....	484	FÜHR.PROBES BRUNNER .....	221	GRAEFFE FIXATION FORCEPS .....	389
FINOCCHIETTO-BABY RIB SPREADER .....	482	FÜHR.PROBES PAYR .....	221	GRAEFFE IRIS TISSUE FORCEPS .....	382
FINOCCHIETTO-BURFORD RIB SPREADER .....	483	FÜHR.PROBES VIENNA .....	221	GRAEFFE SCISSORS.....	56
FINSEN RETRACTOR .....	168	<b>G</b>		GRAEFFE STRABISMUS HOOK .....	375
FISCH DISSECTOR .....	420	GALEAHOOK YASARGIL .....	330	GRAEFFE TISSUE FORCEPS .....	83
FISCH FINE HOOK .....	335	GALL DUCT DILATOR BAKES .....	532	GRAEVE HOOK .....	149
FISCHER IRIS TISSUE FORCEPS .....	384	GALL STONE CURETTE DESJARDINS .....	534	GRAEFFE EYE SPECULA .....	370
FISH PROBES .....	199	GALL STONE CURETTE FERGUSSON .....	533	GRAHAM NERVE HOOK .....	328
FISHER TONSIL-KNIVES .....	466	GALL STONE CURETTE LUER-KOERTE.....	533	GRASPING FORCEPS .....	316
FISTULA HOOK EMMETT .....	594	GALL STONE CURETTE MAYO .....	534	GRASPING FORCEPS .....	415
FISTULA PROBES PRATT.....	563	GALL STONE CURETTE MOOR .....	532	GRASPING FORCEPS LAHEY .....	479
FISTULAPROBES LOCKHART-MUMMERY .....	200	GALL STONE FORCEPS BLAKE .....	531	GRASPING FORCEPS MARTEL .....	110
FIXATION FORCEPS BARRAQUER.....	390	GALL STONE FORCEPS BLAKE .....	531	GRASPING FORCEPS PRATT .....	110
FIXATION FORCEPS CASTROVIEJO .....	390	GALL STONE FORCEPS DESJARDINS .....	531	GRASPING FORCEPS WILLET MARTEL.....	110
FIXATION FORCEPS COTTLE .....	410	GALL STONE FORCEPS MAYO-BLAKE .....	531	GRASPING TISSUE FORCEPS COLLIN-DUAL .....	85
FIXATION FORCEPS ELSCHNIG .....	389	GALL STONE FORCEPS MIXTER .....	531	GRASPING TISSUE FORCEPS DURANTE .....	88
FIXATION FORCEPS GRAEFE .....	389	GALL STONE PROBES DESJARDINS .....	532	GRASPING TISSUE FORCEPS DUVAL .....	85
FIXATION FORCEPS GREEN .....	390	GALL STONE PROBES MAYO .....	534	GRASPING TISSUE FORCEPS LERCHE.....	83
		GALL STONE PROBES MOYNIHAN .....	532	GRASPING TISSUE FORCEPS RUSS MODELL .....	85
		GALLAHER ANTRUM RASP .....	446	GRAVE VAGINAL SPECULA .....	570





GRAY HEMOSTATIC CLAMP.....	121	HARGIS AWL.....	463	HEMOSTATIC CLAMP LAHEY.....	120
GREEN CORNEAL DISSECTOR.....	374	HARGIS MANDIBULAR BODY RETRACTOR.....	463/6	HEMOSTATIC CLAMP LAWRENCE.....	119
GREEN FIXATION FORCEPS.....	390	HARGIS RASPATORY.....	463/2	HEMOSTATIC CLAMP LERICHE.....	111
GREEN MUSCLE HOOK.....	375	HARKEN AURIKELCLAMP.....	503	HEMOSTATIC CLAMP LEVELACE.....	109
GREEN RETRACTOR.....	160	HARMS LACHRYMAL PROBES.....	381	HEMOSTATIC CLAMP LOWER.....	120
GREEN-ARMYTAG.....	605	HARMS PROBES.....	333	HEMOSTATIC CLAMP MAYO-GUYON.....	122
GREVEN MICRO-EAR FORCEPS.....	414	HARRINGTON BRONCHUSCLAMP.....	490	HEMOSTATIC CLAMP MEEKER.....	119
GROSS EAR CURETTE.....	409	HARRINGTON HOOK.....	193	HEMOSTATIC CLAMP MICRO-HARTMANN.....	104
GROSS-MAIER DRESSINGFORCEPS.....	134	HARRINGTON -PEMBERTON RETRACTOR.....	147	HEMOSTATIC CLAMP MIXTER.....	119, 121
GRUBER EAR SPECULA.....	399	HARRINGTON RETRACTOR.....	147	HEMOSTATIC CLAMP MIXTER-BABY.....	119
GUIDE DRIVER.....	321	HARTMANN EAR CATHETER.....	408	HEMOSTATIC CLAMP MOYNIHAN.....	121
GUIDE NEEDLE REDON.....	207	HARTMANN EAR SPECULA.....	399	HEMOSTATIC CLAMP O'SHAUGNESSY.....	120
GUIDEPROBES KÖNIG.....	221	HARTMANN FOREIGN-BODY FORCEPS.....	412	HEMOSTATIC CLAMP OVERHOLT.....	114
GUIDEPROBES BRUNNER.....	221	HARTMANN FOREIGN-BODY LEVER.....	411	HEMOSTATIC CLAMP PEAN.....	108
GUIDEPROBES KIRSCHNER.....	221	HARTMANN HEMOSTATIC CLAMP.....	104	HEMOSTATIC CLAMP PEAN.....	110
GUIDEPROBES SCHMIEDEN.....	221	HARTMANN IRRIGATION CANNULA.....	433	HEMOSTATIC CLAMP PENNINGTON.....	109
GUIDEPROBES SCHMIEDEN-PAYR.....	221	HARTMANN NOSE SPECULA.....	422, 427	HEMOSTATIC CLAMP PROVIDENCE-HOSPITAL.....	106
GUILLEN SUCTION RASPATORIES.....	433/1	HARTMANN POLYP FORCEPS.....	424	HEMOSTATIC CLAMP ROBERTS.....	117
GUM SCISSORS LA GRANGE.....	69	HARTMANN TONGUE DEPRESSORS.....	452	HEMOSTATIC CLAMP ROCHESTER-CARMALT.....	109
GUMSCISSORS GOLDMAN-FOX.....	67	HARTMANN TUNING FORC.....	403	HEMOSTATIC CLAMP ROCHESTER-OCHSNER.....	108
GUMSCISSORS LOCKLIN.....	69	HARTMANN-HALLE NOSE SPECULA.....	421	HEMOSTATIC CLAMP ROCHESTER-PEAN.....	108
GUMSCISSORS QUINBY.....	67	HARTMANN-HOFFMANN FOREIGN-BODY FORCEPS.....	412	HEMOSTATIC CLAMP RUMEL.....	117
GUTHRIE SKIN HOOK.....	149	HARTMANN-WULLSTEIN FOREIGN-BODY FORCEPS.....	412	HEMOSTATIC CLAMP SAROT.....	118
GUYON CATHETER EINGUIDE.....	554	HAUGH MICRO-EAR FORCEPS.....	414	HEMOSTATIC CLAMP S-CVD MIXTER.....	116
GUYON DILATION BOUGIE.....	554	HAYES RECTUM-ANAST.KL.....	545	HEMOSTATIC CLAMP SPENCER-WELLS.....	109
GUYON HEMOSTATIC CLAMP.....	122	HEAD HOLDER CRUTCHFIELD.....	327	HEMOSTATIC CLAMP STILLE.....	122
GUYON KIDNEY CLAMP.....	122	HEAD LIGHTS CLAR KPLT.....	22	HEMOSTATIC CLAMP TOENNIS.....	117
GUYTON-LUNDSGAARD SKLEROTOM.....	373	HEAD MIRRORS ZIEGLER.....	21	HEMOSTATIC CLAMP WIKSTROEM.....	117
GYNECOLOGICAL SCISSORS DOYEN.....	63	HEAD PUNCH CONE.....	331	HEMOSTATIC CLAMP ZENKER.....	118
GYNECOLOGICAL SCISSORS DUBOIS.....	63	HEANEY HYSTERECTOMYCLAMP.....	126	HEMOSTATIC CLAMP OVERHOLT-BABY.....	114
GYNECOLOGICAL SCISSORS SIEBOLD.....	62	HEANEY NEEDLE HOLDER.....	210	HEMOSTATIC CLAMP OVERHOLT-GEISSENDÖRFER.....	114
GYNECOLOGICAL SCISSORS SIMS.....	62	HEANEY BIOPSY CURETTE.....	587	HEMOSTATIC CLAMP OVERHOLT-MIXTER.....	115
GYNECOLOGICAL SCISSORS WERTHEIM.....	63	HEANY RETRACTOR.....	164	HEMOSTATS.....	259
H.....		HEANY-BALLETINE HYSTERECTOMYCLAMP.....	127	HENKE TONSIL-ELEVATOR.....	465
HABERER BOWEL SPATULA.....	143/1	HEATH HAMMER.....	273	HENLEY RETRACTORS.....	170
HAEMORRHOIDAL LIGATOR MC GIVNEY.....	568	HEATH SUTURE SCISSORS.....	66	HENNING PLASTER RETRACTOR.....	232
HAEMORRHOIDALCLAMP FERGUSSON.....	109	HEBRA CHALAZIO CURETTE.....	377	HEPP-SCHEIDEL MICRO-SCISSORS.....	78
HAEMORRHOIDALFORCEPS HEYWOOD-SMITH.....	567	HEGAR UTERINE DILATOR.....	578, 579	HERRICK NIERNSTIELCLAMP.....	123
HAGLUND-STILLE PLASTER RETRACTOR.....	232	HEGENBARTH CLIP TISSUE FORCEPS.....	224	HESS CAPSULAR FORCEPS.....	391
HAIGHT RIB SPREADER.....	487	HEIFETZ BRAIN SPATULA.....	369	HESS IRIS TISSUE FORCEPS.....	384
HAJEK HAMMER.....	273	HEIMING KIDNEY STONE FORCEPS.....	536	HEYMANN SEPTUM FORCEPS.....	425
HAJEK SEPTUM CHISELS.....	442/1	HEISS HEMOSTATIC CLAMP.....	112	HEYMANN NOSE SCISSORS.....	58
HAJEK-BALLENGER ELEVATOR.....	439	HEISTER MOUTH GAGS.....	454	HEYMANN-KNIGHT EAR FORCEPS.....	425
HAJEK-KOFLER RONGEUR.....	429, 431	HEMOSTATIC CLAMP ADSON.....	112	HEYWOOD-SMITH HAEMORRHOIDAL FORCEPS.....	567
HALLE BONE CURETTES.....	253	HEMOSTATIC CLAMP ADSON-BABY.....	113	HIBBS CHISELS.....	265
HALLE SEPTUM ELEVATOR.....	437	HEMOSTATIC CLAMP BAINBRIDGE.....	120	HIBBS GOUGES.....	265
HALOGEN LAMP FOR LARYNGOSCOPE.....	29	HEMOSTATIC CLAMP BENGOLEA.....	112	HIBBS RETRACTOR.....	164
HALSEY NEEDLE HOLDER.....	208	HEMOSTATIC CLAMP BIRKETT.....	116	HILL-FERGUSON RECTAL-SPECULA.....	560
HALSTED-MOSQUITO HEMOSTATIC CLAMP.....	105	HEMOSTATIC CLAMP BRIDGE.....	116	HIRSCHMAN SPATULA.....	331
HAMMER.....	270, 272	HEMOSTATIC CLAMP COLLER-CRILE.....	106	HIRSCHMANN ANOSCOPE.....	562
HAMMER BERGMANN.....	272	HEMOSTATIC CLAMP CRAFOORD.....	118	HOEN DURA DISSECTOR.....	333
HAMMER COLLIN.....	270	HEMOSTATIC CLAMP CRAFOORD-SELLORS.....	118	HOESEL NEEDLE HOLDER.....	213
HAMMER COTTLE.....	273	HEMOSTATIC CLAMP CRILE.....	107	HOFER RETRACTOR.....	465
HAMMER GERZOG.....	270	HEMOSTATIC CLAMP CRILE-RANKIN.....	107	HOFFMANN TUBING CLAMP.....	624
HAMMER HAJEK.....	273	HEMOSTATIC CLAMP DANDY.....	109	HOHMANN BONE LEVERS.....	284, 285
HAMMER HEATH.....	273	HEMOSTATIC CLAMP DEBAKEY-MOSQUITO.....	509	HOHMANN MINI.....	286
HAMMER KIRK.....	270	HEMOSTATIC CLAMP DEBAKEY-PEAN.....	513	HOKE CHISELS.....	265
HAMMER LUCAE.....	271	HEMOSTATIC CLAMP DEBAKEY-RANKIN.....	512	HOLDING ARM SYSTEM LEYLA.....	368, 368/1, 368/3, 368/4
HAMMER MEAD.....	271	HEMOSTATIC CLAMP DESJARDINS.....	121	HOLDING CLAMP ADSON.....	298
HAMMER OMBREDANNE.....	273	HEMOSTATIC CLAMP FUCHSIG.....	113	HOLINGER OP-LARYNGOSCOPE.....	37
HAMMER PARTSCH.....	271	HEMOSTATIC CLAMP GEMINI.....	115	HOLLINGER LIGHT GUIDE.....	37
HAMMER QUISLING.....	271	HEMOSTATIC CLAMP GRAY.....	121	HOLSHER NERVE HOOK.....	329
HAMMER WILLIGER.....	271	HEMOSTATIC CLAMP GUYON.....	122	HOLTH RONGEUR.....	380
HÄMORRHOID.FORCEPS MCGIVNEY.....	568	HEMOSTATIC CLAMP HALSTED-MOSQUITO.....	105	HOLZBACH HYSTERECTOMYCLAMP.....	126
HÄMORRHOID.LIGATORRUDD.....	568	HEMOSTATIC CLAMP HALSTED-MOSQUITO TITANIUM.....	105	HOLZBACH HYSTERECTOMYCLAMP.....	126
HANDLE WITH JACOBS CHUCK.....	300	HEMOSTATIC CLAMP HARTMANN.....	104	HOLZHEIMER RETRACTOR.....	168
HANDLE ALONE.....	591	HEMOSTATIC CLAMP HEISS.....	112	HOOK.....	419, 475
HANDLE FOR CHISELS/CHISELS.....	266	HEMOSTATIC CLAMP JACOBSON.....	105	HOOK BALFOUR.....	193
HANDLE FOR CHISELS/OSTEO.....	266	HEMOSTATIC CLAMP JOHNS-HOPKINS.....	120	HOOK BARBARA.....	419
HANDLE SCALPEL.....	38, 39, 39/1, 39/2, 40, 41	HEMOSTATIC CLAMP KANTROWITZ.....	119	HOOK DAY.....	409
HANDLE SCALPEL MINI.....	41	HEMOSTATIC CLAMP KELLY.....	106	HOOK FISCH.....	335
HANK UTERINE DILATOR.....	580	HEMOSTATIC CLAMP KELLY-RANKIN.....	106	HOOK FORCEPS BARRET.....	582
		HEMOSTATIC CLAMP KOCHER.....	108	HOOK FORCEPS BRAUN.....	582



HOOK FORCEPS CZERNY.....	584	INTERCHANGEABLE TIPS KRAUSE.....	472	JEWELRY TISSUE FORCEPS.....	90
HOOK FORCEPS DUPLAY.....	582	INTERCHANGEABLE TIPS LANGE.....	472	JOBSON-HORNYE COTTON-APPLICATOR.....	203
HOOK FORCEPS HULKA.....	583	INTERCHANGEABLE TIPS SCHEINMANN.....	472	JOHNS_HOPKINS APPLIERFORCEPS.....	104
HOOK FORCEPS IOWA.....	584	INTERCHANGEABLE TIPS SCHUMACHER.....	472	JOHNS-HOPKINS BULLDOG CLAMP.....	104
HOOK FORCEPS JACOBS.....	583	INTERCHANGEABLE TIPS SEIFERT.....	472	JOHNS-HOPKINS HEMOSTATIC.....	120
HOOK FORCEPS JARCHO.....	583	INTERVERTEBRAL DISC RONGEUR COLCLOUGH.....	344/1	JOHNSON NEEDLE HOLDER.....	211
HOOK FORCEPS MUSEUX.....	583	INTRA ORAL RETRACTORS.....	463/1, 463/4	JONES TOWEL CLAMP.....	132
HOOK FORCEPS PRATT.....	584	INTRAMEDULLARY PINS.....	322	JONES-CLIP TOWEL CLAMP.....	132
HOOK FORCEPS SCHRÖDER.....	584	INZISIONSSCISSORS.....	52	JORGENSEN DISSECTING SCISSORS.....	53
HOOK FORCEPS SCHROEDER.....	583	IOWA HOOK FORCEPS.....	584	JOSEPH (LEWIS) NOSER.....	443
HOOK FORCEPS SCHROEDER (POZZI).....	582	IOWA NEEDLE GUIDE.....	206	JOSEPH NOSE RASP.....	443
HOOK FORCEPS SKENE.....	582	IRIS HOOK O'CONNOR.....	375	JOSEPH NOSESAW.....	446
HOOK FORCEPS TEALE.....	583	IRIS HOOK WIENER.....	375	JOSEPH RASPIATORIES.....	277
HOOK FORCEPSSTAUDE-MOORE.....	582	IRIS KNIVES DEAN.....	372	JOSEPH SEPTUM.....	437
HOOK GASS.....	376	IRIS KNIVES KNAPP.....	372	JOSEPH SEPTUM KNIVES.....	434
HOOK GELPI.....	193	IRIS KNIVES ZIEGLER.....	372	JOSEPH SEPTUM KNIVES.....	434, 435
HOOK HARRINGTON.....	193	IRIS SCISSORS.....	54	JOSEPH SKIN HOOK.....	149
HOOK KELLY.....	193	IRIS SCISSORS KNAPP.....	55	JOSEPH SURGICAL SCISSORS.....	54
HOOK KUGLEN IRIS.....	376	IRIS SCISSORS LITTLER.....	55	JUDD-ALLIS BOWEL GRASPING FORCEPS.....	538
HOOK LUCAE.....	409	IRIS SPATULA CULLER.....	378	JUDD-MASSON BLADDER RETRACTORS.....	552
HOOK MCGEE.....	419	IRIS SPATULA WECKER.....	378	JUERS MICRO-EAR FORCEPS.....	414
HOOK SCOVILLE.....	196	IRIS SUPERCUT SCISSORS.....	72	JURASZ LARYNGEAL POLYPUS FORCEPS.....	471
HOOK SINSKEY.....	376	IRIS TISSUE FORCEPS BARRAQUER-KATZIN.....	384		
HOOK SMELLIE.....	605	IRIS TISSUE FORCEPS BISHOP-HARMAN.....	386	<b>K</b>	
HOOK WAGENER.....	409	IRIS TISSUE FORCEPS BONN.....	387	KABIERSCHE POWDER BLOWER.....	405
HOOKST.EVENS.....	375	IRIS TISSUE FORCEPS FISCHER.....	384	KADER ABDOMINAL SPATULA.....	143/1
HOPKINS PLASTER KNIVES.....	233	IRIS TISSUE FORCEPS FOERSTER.....	383	KALLMORGEN SPECULA.....	573
HORIZON CLIP FORCEPS.....	524	IRIS TISSUE FORCEPS GILL.....	384	KALT CAPSULAR FORCEPS.....	391
HORNY SKIN SCISSORS CASTROVIEJO.....	79	IRIS TISSUE FORCEPS GILL-HESS.....	384	KALT NEEDLE HOLDER.....	214
HORSLEY DURA DISSECTOR.....	333	IRIS TISSUE FORCEPS GRAEFE.....	382	KALT NEEDLE HOLDER.....	214
HÖSEL RETRACTOR.....	167	IRIS TISSUE FORCEPS HESS.....	384	KALT-ARRUGA NEEDLE HOLDER.....	214
HOUSE CURETTE.....	420	IRIS TISSUE FORCEPS KIRBY-ARTHUR.....	385	KANE NAVELSTRINGCLAMP.....	605
HOUSE SUCTION TUBE.....	337/2	IRIS TISSUE FORCEPS MODELL BONN.....	387	KANTROWITZ HEMOSTATIL.....	119
HOWARTH SEPTUM ELEVATOR.....	438	IRIS TISSUE FORCEPS TROUTMAN.....	384, 389	KAYE FACE LIFT SCISSORS.....	73
HUBER UNIVERSALHANDLE.....	472	IRIS TISSUE FORCEPS TYPE TUEBINGEN.....	387	KEINSSASSER OP-LARYNGOSCOPE.....	35
HUDSON BONE HAND DRILLS.....	299	IRIS TISSUE FORCEPSSTEVENS.....	383	KEITH NEEDLE.....	223
HUDSON T-HANDLE.....	300	IRRIGATION CANNULA EICKEN (KILLIAN).....	433	KELLY GRIP RETRACTOR.....	142
HULKA HOOK FORCEPS.....	583	IRRIGATION CANNULA HARTMANN.....	433	KELLY HEMOSTATIC CLAMP.....	106
HUMBY DERMATOM.....	50	IRRIGATION CANNULA KILLIAN.....	433/1	KELLY HOOK.....	193
HUNTER SPLINTER FORCEPS.....	91	IRRIGATION CANNULA KILLIAN.....	433/1	KELLY PROCTOSCOPE.....	562, 563
HURD TONSIL ELEVATOR.....	465	IRRIGATION CANNULA RITTER-HALLE.....	433	KELLY RETRACTOR.....	164
HYPOPHYSE CURETTE.....	334	IRRIGATION CANNULA SIEBENMANN.....	433/1	KELLY UTERINE POLYP FORCEPS.....	585
HYPOPHYSEN FORCEPS.....	341	IRRIGATION CANNULA SIMCOE.....	394/2	KELLY VASCULAR SCISSORS.....	61
HYPOPHYSE-TISSUE FORCEPS ADSON.....	334	IRRIGATIONSCANNULA TYPE LACRIMAL.....	394	KELLY-RANKIN HEMOSTATIC CLAMP.....	106
HYSTERECTOMY FORCEPS WERTHEIM-CULLEN.....	125	ISRAEL RETRACTOR.....	162	KERATOPLAST.-KNIVES BARRAQUER.....	373
HYSTERECTOMY SCISSORS WERTHEIM.....	63	ITERSON TRACHEA HOOK.....	477	KERATOPLAST.-KNIVES PAUFIQUE.....	373
HYSTERECTOMYCLAMP HEANEY.....	126	IVES-FANSLER ANOSCOPE.....	562	KERN BONE HOLDING FORCEPS.....	244
HYSTERECTOMYCLAMP HEANY-BALLENTINE.....	127	IWANSON MEASURING INSTRUMENT.....	624	KERRISON RONGEUR.....	428
HYSTERECTOMYCLAMP ROGERS.....	127			KEVORKIAN BIOPSY CURETTE.....	587
HYSTERECTOMYCLAMP SEGOND.....	125	<b>J</b>		KEVORKIAN BIOPSY FORCEPS.....	589, 591
HYSTERECTOMYCLAMP SEGOND-LANDAU.....	125	JACKSON LARYNGOSCOPE.....	37	KEVORKIAN-PACIFIC BIOPSY FORCEPS.....	592
HYSTERECTOMYCLAMP WERTHEIM.....	124	JACKSON TENDON GRASPING FORCEPS.....	292	KEY ELEVATOR.....	282
HYSTERECTOMYCLAMP WERTHEIM.....	128	JACKSON TRACHEA HOOK.....	476	KEYES PUNCH.....	608
		JACKSON VAGINAL SPECULA.....	573	KIDNEY CLAMP GUYON.....	122
<b>I</b>		JACKSON-BURROWS RETRACTOR.....	189/2	KIDNEY FORCEPS HERRICK.....	123
I.A.D. EXTRAKTION HOOK.....	593	JACOBS HOOK FORCEPS.....	583	KIDNEY STONE FORCEPS HEIMING.....	536
I.A.D. GRASPING FORCEPS FLEXIBLE SERPENTINE.....	593	JACOBSON BUTTONPROBES.....	335	KIDNEY STONEFORCEPS RANDALL.....	535
ILLUMINATION ATTACHMENT.....	562	JACOBSON CURETTE.....	257	KIDNEY TRAY.....	619
IMPACTOR.....	322	JACOBSON DURA HOOK.....	335	KIELLAND OBSTETRICAL FORCEPS.....	602
IMPACTOR/EXTRACTOR.....	322	JACOBSON HEMOSTATIC CLAMP.....	105	KIELLAND-LUIKART OBSTETRICAL FORCEPS.....	603
IMPACTOR/EXTRAKTOR.....	322	JACOBSON NEEDLE HOLDER.....	215	KILLIAN GOUGES.....	442/1
INEROSSEOUSSCISSORS MCINDOE.....	65/1	JAEGER DISCISION MESSR.....	372	KILLIAN NOSE SPECULA.....	423
INGE LAMINA SPREADER.....	339	JAEGER LIDPLATTE.....	371	KILLIAN SEPTUM ELEVATO.....	438, 439
INJECTION CANNULA INJECTION CANNULA.....	36	JAMESON STRABISMUS FORCEPS.....	385	KILLIAN SEPTUM SCISSORS.....	471
INSTRU-CARE INSTRUMENT OIL.....	634	JAMESON STRABISMUS HOOK.....	375	KILLIAN-CLAUS SEPTUM GOUGES.....	442/1
INSTRUMENT BOX.....	617	JANSEN BONE CURETTES.....	257	KILNER NEEDLE HOLDER.....	212
INSTRUMENT OIL INSTRU CARE.....	634	JANSEN BONE RONGEUR.....	237	KILNER NOSE HOOK.....	447/1
INSUFFLATIONCANNULA VERESS.....	206	JANSEN EAR FORCEPS.....	424	KILNER SKIN HOOK.....	608
INTERCHANGEABLE TIPS BARACANI.....	472	JANSEN RETRACTOR.....	168	KILNER SURGICAL SCISSORS.....	54
INTERCHANGEABLE TIPS BRUENINGS.....	472	JAR.....	620	KILNER/RAGNELL SUPERCUT SCISSORS.....	72
INTERCHANGEABLE TIPS CORDES.....	472	JARCHO HOOK FORCEPS.....	583	KILNER-DOUGHTY.....	456
INTERCHANGEABLE TIPS FRAENKEL.....	472	JAVID CAROTIS SHUNT CLAMP.....	511	KIRBY-ARTHUR IRIS FORCEPS.....	385
INTERCHANGEABLE TIPS FRAENKEL.....	472	JENNINGS MOUTH GAGS.....	454	KIRK HAMMER.....	270



KIRSCHNER ABDOMINAL RETRACTOR.....187, 187/1  
 KIRSCHNER ABDOMINALRETRACTORS .....185, 187  
 KIRSCHNER BONE HAND DRILLS .....299  
 KIRSCHNER DRILLWIRE .....306, 307  
 KIRSCHNER GUIDEPROBES .....221  
 KIRSCHNER NAIL.....308, 309  
 KIRSCHNER US EXTENSION BOW .....312  
 KLAPP RETRACTOR.....150  
 KLEINERT-KUTZ HOHLMEIB .....237  
 KLEINERT-KUTZ SKIN HOOK.....149  
 KLEINERT-KUTZ TENDON GRASPING INSTRUMENT ...294  
 KLEINSASSER CHEST SUPPORT.....36  
 KLEINSASSER FIBERGLAS-LIGHT GUIDE.....36  
 KLEINSASSER INJECTION CANNULA.....36  
 KLEINSASSER SUCTION TUBE TUBE .....36  
 KLEINSCHMIDT APPENDIXBOWEL CLAMP.....544  
 KLINKENBERGH-LOTH VASCULAR SCISSORS .....65/1  
 KNAPP CATARACT CURETTE .....378  
 KNAPP EXTRACTION HOOK.....375  
 KNAPP IRIS KNIVES .....372  
 KNAPP IRIS SCISSORS.....55  
 KNAPP-LUER TRACHOMA FORCEPS.....393  
 KNIGHT SEPTUM FORCEPS.....425  
 KNIVES AMPUTATION .....44  
 KNIVES BALLENGER.....436  
 KNIVES BONE.....44  
 KNIVES LANGENBECK.....47  
 KNIVES MUCK.....420  
 KNIVES PLESTER .....418  
 KNIVES ROSEN.....418  
 KNIVES SCHUKNECHT .....418  
 KNIVES TABB.....418  
 KNIVESWULLSTEIN.....418  
 KNOWLES BANDAGE SCISSORS.....70  
 KOCHER BLADDER SPATULA.....552  
 KOCHER BOWEL CLAMP .....540  
 KOCHER HEMOSTATIC CLAMP.....108  
 KOCHER PROBES .....479  
 KOCHER RETRACTOR.....155, 160, 163  
 KOCHER-LANGENBECK RETRACTOR.....159  
 KOENIG NEEDLE .....223  
 KOERTE RETRACTOR .....162  
 KOGAN ENDOSPECULA.....577  
 KÖNIG BONE LEVERS.....284  
 KÖNIG GUIDEPROBES.....221  
 KÖNIG RASPTORIES.....276  
 KÖNIG RETRACTOR.....153  
 KOOS DURA KNIVES.....335  
 KOPFSCHWARTENFORCEPS GAUSS.....605  
 KRAUSE INTERCHANGEABLE TIPS .....472  
 KRAUSE POLYP SNARE.....433/2  
 KRAUSE POLYP SNARE.....411, 434  
 KRAUSE-VOSS POLYP SNARE.....433/2  
 KRAYENBÜHL NERVE HOOK.....336  
 KRISTELLER SPECULA .....572  
 KRISTELLER VAGINAL SPECULA.....572  
 KROENIG TONGUE DEPRESSORS.....451  
 KRONECKER LIGATUREE NEEDLE .....219  
 KUGLEN HOOK.....376  
 KUHN T CORNEAL SCLEROTOME.....373  
 KÜMMEL ABDOMINAL- A. BOWEL SPATULA....143/2, 144  
 KÜNTSCHER DRIVER .....321  
 KÜNTSCHER EXTRACTOR.....322  
 KÜNTSCHER REAMER.....321

**L**  
 LA FORCE ADENOID CURETTE.....450  
 LA FORCE FOREIGN-BODY NEEDLE .....374  
 LA GRANGE GUM SCISSORS .....69  
 LABORDE TRACHEA DILATOR .....476  
 LACHRYMAL DILAT. WILDER.....381  
 LACHRYMAL DILAT.CASTROVIEJO .....381  
 LACHRYMAL DILATOR ZIEGLER .....381

LACHRYMAL PROBES BOWMAN .....381  
 LACHRYMAL PROBES HARMS .....381  
 LACRIMAL IRRIGATIONS CANNULA .....394  
 LAGRANGE SUPER CUT SCISSORS .....72  
 LAHEY GRASPING FORCEPS .....479  
 LAHEY HEMOSTATIC CLAMP .....120  
 LAHEY RETRACTOR.....149, 157  
 LAMBERT CHALAZIO TISSUE FORCEPS .....393  
 LAMBERT-KAY AORTIC-ANASTOMOSIS CLAMP .....505  
 LAMBERT-LOWMAN BONE HOLDING CLAMP .....249  
 LAMBOTTE BONE HOLDING FORCEPS.....244  
 LAMBOTTE CHISELS.....261  
 LAMBOTTE RASPTORIES.....274, 275  
 LAMINA SPREADER CLOWARD .....339  
 LAMINA SPREADER INGE.....339  
 LAMINECTOMY RETRACTOR CHERRY .....488  
 LAMINECTOMY RETRACTOR FORCEPS CLOWARD ...342  
 LAMINECTOMY RETRACTOR FORCEPS OLD BERG ...341  
 LAMINECTOMY RETRACTOR FORCEPS SCHLESINGER .....342  
 LAMINECTOMY RETRACTOR FORCEPS SPURLING ...340  
 LAMINECTOMY RETRACTOR FORCEPS WAGNER....343  
 LAMINECTOMY RETRACTOR FORCEPSCUSHING .....340  
 LAMINECTOMY RETRACTOR FORCEPSFERRIS-SMITH .....343  
 LAMINECTOMY RETRACTOR FORCEPSLOVE-GRUENWALD .....340  
 LAMINECTOMY RETRACTOR SCOVILLE .....196  
 LAMINECTOMY RETRACTOR SCOVILLE-HAVERFIELD ...196  
 LANCASTER EYE SPECULA .....371  
 LANCETTE ELECTRODE MONOPOLAR .....628, 629  
 LANDAU VAGINAL SPECULA.....577  
 LANDOLT TUMOR GRASPING FORCEPS .....341  
 LANE BENDER .....325  
 LANE BONE HOLDING FORCEPS .....244  
 LANE BONE LEVERS .....290  
 LANE BONE LEVERS .....290  
 LANE BONE PLATE HOLDING FORCEPS .....325  
 LANE SCREW DRIVER.....323, 324  
 LANE SREWHOLDINGFORCEPS .....325  
 LANE STOMACH CLAMP .....547  
 LANE SURGICAL TISSUE FORCEPS .....84  
 LANE TOWEL CLAMP .....133  
 LANE TRETOWAN BONE LEVERS.....290  
 LANG EXTRACTION DISSECTOR .....378  
 LANGE INTERCHANGEABLE TIPS.....472  
 LANGE NOSE HOOK .....448  
 LANGE-HOHMANN.....286  
 LANGENBECK FINGER PROTCTOR.....311  
 LANGENBECK AMPUTATION KNIVES .....44  
 LANGENBECK BONE HOLDING FORCEPS .....243  
 LANGENBECK EAR LOOP .....409  
 LANGENBECK FINGER SAW .....296  
 LANGENBECK KNIVES .....47  
 LANGENBECK NEEDLE HOLDER .....213  
 LANGENBECK RASPTORIES.....275  
 LANGENBECK RETRACTOR.....158, 159  
 LANGENBECK-GREEN RETRACTOR .....153  
 LARSEN TENDON GRASPING FORCEPS.....292  
 LARYNGEAL CANNULA WIE .....470  
 LARYNGEAL MIRROR.....473  
 LARYNGEAL MIRROR MICHEL.....423  
 LARYNGEAL POLYPUS FORCEPS FRAENKEL .....471  
 LARYNGEAL POLYPUS FORCEPS JURASZ .....471  
 LARYNGOSCOPE COLD LIGHTHANDLE BATTERY HANDLE .....33  
 LARYNGOSCOPE FOREGGER.....29, 31  
 LARYNGOSCOPE HOLLINGER .....37  
 LARYNGOSCOPE JACKSON .....37  
 LARYNGOSCOPE MCINTOSH .....29, 31  
 LARYNGOSCOPE MILLER.....30  
 LARYNGOSCOPE WARM LIGHT BATTERY HANDLE .....32

LARYNGOSCOPE WARM LIGHT HANDLE WITH TRANSFORMER CONNECTION .....34  
 LATERAL VAGINAL RETRACTOR .....569  
 LAWRENCE HEMOSTATIC CLAMP .....119  
 LEAD HAND .....250  
 LEBSCH CHISEL.....267  
 LEES BRONCHUSCLAMP.....504  
 LEGUE BLADDER RETRACTORS .....553  
 LEGUEU BLADDER SPATULA .....552  
 LEKSELL(STILLE) BONE RONGEUR .....240  
 LELAND-JONES VASCULARSCLAMP .....494  
 LEMPERT BONE CURETTES.....256  
 LEMPERT BONE RONGEUR .....237  
 LEMPERT ELEVATOR.....420  
 LERICHE GRASPING TISSUE FORCEPS.....83  
 LERICHE ABDOMINALSPATULA .....143/2  
 LERICHE BOWEL SPATULA .....143/2  
 LERICHE HEMOSTATIC CLAMP .....111  
 LESTER FIXATION FORCEPS .....389  
 LEVINSON FOREIGN-BODY NEEDLE.....374  
 LEWIN BONE HOLDING FORCEPS .....246  
 LEXER BABY DISSECTING SCISSORS .....53  
 LEXER CHISELS.....263  
 LEXER DISSECTING SCISSORS .....53  
 LEXER MINI GOUGES .....263  
 LEYLA HOLDING ARM SYSTEM ...368, 368/1, 368/3, 368/4  
 LICHTENBERG NEEDLE HOLDER .....213  
 LICHTWITZ CANNULA.....433  
 LICHTWITZ TROCAR .....204  
 LIEBERMAN EYE SPECULA .....324  
 LIGATUREE RINGS.....568  
 LIGATUREE NEEDLE.....218  
 LIGATUREE NEEDLE COOPER .....219  
 LIGATUREE NEEDLE DESCHAMPS .....218  
 LIGATUREE NEEDLE KRONECKER .....219  
 LIGATUREE NEEDLE NELSON .....219  
 LIGATUREE NEEDLE SCHMIEDEN-DICK .....219  
 LIGHT GUIDE .....37  
 LIGHT GUIDE COLD LIGHT JACKSON .....37  
 LIGHT GUIDE HOLLINGER .....37  
 LIP RETRACTOR.....453  
 LISTER BANDAGE SCISSORS .....69/1  
 LISTER SUPER CUT SCISSORS .....72  
 LISTER(SINUS) DRESSING FORCEPS .....137  
 LISTER-BURCH EYE SPECULA .....370  
 LISTON AMPUTATION KNIVES .....44  
 LISTON BONE CUTTING FORCEPS .....241  
 LITTAUER CILIA FORCEPS .....395  
 LITTAUER EAR FORCEPS .....411  
 LITTAUER POLYP FORCEPS.....425  
 LITTAUER SUTURES SCISSORS.....66  
 LITTLE RETRACTOR.....157  
 LITTLER IRIS SCISSORS .....55  
 LITTLEWOOD BOWEL GRASPING FORCEPS.....538  
 LOCKHART-MUMMERY FISTULAPROBES .....200  
 LOCKLIN GUM SCISSORS .....69  
 LOCKWOOD-ALLIS BOWEL GRASPING FORCEPS .....538  
 LONDON-COLLEGE TEETH TISSUE FORCEPS .....93  
 LOOP ELECTRODE MONOPOLAR .....628, 629  
 LOPEZ-REINKE TONSIL .....465  
 LORENZ BANDAGE SCISSORS .....70  
 LORNA TOWEL CLAMP .....133  
 LOUPE WIRE INSTRUMENT .....315  
 LOVE NERVE HOOK.....329, 330  
 LOVE RETRACTOR.....465  
 LOVE-GRUENWALD .....340  
 LOVELACE HEMOSTATIC CLAMP .....109  
 LOVELACE LUNG GRASPING FORCEPS .....490  
 LOWER HEMOSTATIC CLAMP .....120  
 LOWMAN BONE HOLDING CLAMP .....249  
 LOWMAN-HOGLUND BONE HOLDING CLAMP .....249  
 LUBET-BARBON NOSE DRESSING FORCEPS .....424  
 LUC SEPTUM FORCEPS.....426





LUCAE EAR FORCEPS.....	410	MC GEE MICRO-EAR FORCEPS.....	414	MIKULICZ PERITONEUMCLAMP.....	123
LUCAE HAMMER.....	271	MCINDOE INEROSSEOUSSCISSORS.....	65/1	MIKULICZ RETRACTOR.....	163
LUCAE HOOK.....	409	MCINDOE TISSUE FORCEPS.....	85	MIKULICZ-BABY PERITONEUMCLAMP.....	123
LUCAE PARACENTESIS NEEDLE.....	408	MCINTOSH LARYNGOSCOP.....	29, 31	MILLER LARYNGOSCOP.....	30
LUCAE TUNING FORC.....	404	MCINTYRE EYE CANNULA.....	394	MILLER NOSE RASP.....	444
LUER BONE RONGEUR.....	236	MCIVOR MOUTH GAGS.....	457	MILLIGAN DURA DISSECTOR.....	332
LUER RETRACTOR.....	140	MCKENY SEPTUM ELEVATOR.....	437, 438	MILLIN BLADDER RETRACTORS.....	552
LUER TRACHEA CANNULA.....	479	MCKENZIE APPLIERFORCEPS.....	326	MILLIN BLADDER SPREADER.....	553
LUER-KOERTE GALL STONE CURETTE.....	533	MCLEAN OBSTETRICAL FORCEPS.....	603	MILLIN CAPSULAR GRASPING FORCEPS.....	551
LUJKART OBSTETRICAL FORCEPS.....	603	MCLEAN-LUIKART OBSTETRICAL FORCEPS.....	603	MILLIN PROSTATIC GRASPING FORCEPS.....	551
LUNDSGAARD SKLEROTOM.....	373	MCLEAN-TUCKER-LUIKART OBSTETRICAL FORCEPS.....	603	MINI BULLDOG CLAMP DEBAKEY-DIETHRICH.....	101
LUNG GRASPING FORCEPS LOVELACE.....	490	MCPHERSON TISSUE FORCEPS.....	392	MINI QUICK HANDLE.....	301
LUNG SCISSORS CRAFOORD.....	65/2	MEAD BONE RONGEUR.....	235	MINI SCALPEL.....	41
LUNG SPATULA ALLISON.....	489	MEAD HAMMER.....	271	MINI SCALPEL HANDLE.....	41
LUNIATSCHKE ELEVATOR.....	465	MEASURANCE CIRCLE CASTROVIEJO.....	380	MINI-BULLDOG CLAMP.....	101
LUPUS CURETTE FOX.....	608	MEASURING INSTRUMENT.....	594	MINI-LAMBOTTE CHISELS.....	262
LUPUS CURETTE PIFFARD.....	608	MEASURING INSTRUMENT.....	594	MINIMUS SPHYGMOMANOMETER.....	11, 12
		MEASURING INSTRUMENT IWANSON.....	624	MINI-TOWNSEND-DOWN BIOPSY FORCEPS.....	591
		MEASURING RULE.....	25	MINI-TOWNSEND-UP BIOPSY FORCEPS.....	591
		MEDICINE CUP.....	621	MIXTER GALL STONE FORCEPS.....	531
		MEDICINE SPOON.....	621	MIXTER HEMOSTATIC CLAMP.....	116, 119, 120, 121
		MEEKER HEMOSTATIC CLAMP.....	119	MIXTER HEMOSTATIC CLAMP S-CVD.....	116
		MEHDORN APPLIER FORCEPS.....	362	MIXTER-BABY HEMOSTATIC CLAMP.....	119
		MEHDORN VASCULAR CLIP.....	362	MIXTER-O'SHAUGNESSY.....	120
		MELLINGER EYE SPECULA.....	370	MIXTER-O'SHAUGNESSY HEMOSTATIC CLAMP.....	120
		MELLINGER-AXENFELD EYE SPECULA.....	370	MODELL BONN IRIS TISSUE FORCEPS.....	387
		MENGHINI BIOPSY NEEDLE.....	206	MOELTGEN GONIOMETER.....	25
		MENISCUSHOOK BLOUNT.....	289	MOGEN CIRCUMCISION INSTRUMENT.....	556
		MENISCUSKNIVES NEFF.....	292	MOLLISON RETRACTORS.....	171
		MENISCUSKNIVES SMILLIE.....	292	MOLT RASPARTORIESIUM.....	276
		MERCEDES THORACIC SPREADER.....	489	MONOPOLAR ELECTRODE BALL.....	628, 629
		MERIAM TEETH TISSUE FORCEPS.....	93	MONOPOLAR ELECTRODE LANCETTE.....	628, 629
		METAL CATHETER.....	555	MONOPOLAR ELECTRODE LOOP.....	628, 629
		METAL CATHETER COXETER.....	555	MONOPOLAR ELECTRODE NEEDLE.....	628, 629
		METZENBAUM "S" SURGICAL SCISSORS.....	54	MOOR GALL STONE CURETTE.....	532
		METZENBAUM DISSECTING SCISSORS.....	53/1	MOORE BONE HAND DRILLS.....	298
		METZENBAUM FINO TC DISSECTING SCISSORS.....	53/1	MOORFIELD TISSUE FORCEPS.....	392
		METZENBAUM NEEDLE HOLDER.....	211	MORGAN PROCTOSCOPE.....	565
		METZENBAUM SUPERCUT SCISSORS.....	71	MORITZ-SCHMIDT TONGUE DEPRESSORS.....	452
		METZENBAUM TC DISSECTING SCISSORS.....	53/1	MORRIS RETRACTOR.....	164
		MEYERDING RETRACTOR.....	157	MORRIS-DEBAKEY AORTIC CLAMP.....	506
		MEYERDING RETRACTORS.....	180	MORSE RIB SPREADER.....	484
		MEYHOEFER CHALAZIO CURETTE.....	377	MORSE-FAVALORO RIB SPREADER.....	484
		MICHEL CLIP.....	224	MOUTH GAGS DAVIS-BOYLE.....	455
		MICHEL CLIP FORCEPS.....	224	MOUTH GAGS DENHART.....	454
		MICHEL CLIP TISSUE FORCEPS.....	224	MOUTH GAGS DINGMANN.....	456
		MICHEL LARYNGEAL MIRROR.....	423	MOUTH GAGS HEISTER.....	454
		MICRO FRIEDMANN.....	234	MOUTH GAGS JENNINGS.....	454
		MICRO FRIEDMANN BONE RONGEUR.....	234	MOUTH GAGS MCIVOR.....	457
		MICRO SICKLE KNIVES.....	475	MOUTH GAGS ROSER-KOENIG.....	454
		MICRO-CURETTE FORCEPS WULLSTEIN.....	416	MOUTH GAGSDOYEN-JANSEN(MOLT).....	454
		MICRO-EAR FORCEPS.....	413	MOYNIHAN GALL STONE PROBES.....	532
		MICRO-EAR FORCEPS COS.....	414	MOYNIHAN HEMOSTATIC CLAMP.....	121
		MICRO-EAR FORCEPS DIETER.....	414	MOYNIHAN TOWEL CLAMP.....	133
		MICRO-EAR FORCEPS GREVEN.....	414	MUCK KNIVES.....	420
		MICRO-EAR FORCEPS HAUGH.....	414	MUELLER EYE SPECULA.....	371
		MICRO-EAR FORCEPS JUERS.....	414	MÜLLER APPROXIMATOR.....	364
		MICRO-EAR FORCEPS MCGEE.....	414	MÜLLER VASCULAR CLIP.....	365
		MICRO-EAR SCISSORS BELLUCCI.....	413	MURDOCK EYE SPECULA.....	370
		MICRO-EAR SCISSORS SHEA.....	413	MURPHY RETRACTOR.....	156
		MICRO-GRASPING FORCEPSREARSCHAFT.....	415	MURPHY-LANE ELEVATOR.....	283
		MICRO-HARTMANN HEMOSTATIC CLAMP.....	104	MUSCLE CLAMP MASTIN.....	479
		MICRO-SCISSORS.....	76, 77, 78, 80	MUSCLE FORCEPS PRINCE.....	387
		MICRO-SCISSORS GOMEL.....	80	MUSCLEHOOK.....	267
		MICRO-SCISSORS HEPP-SCHEIDEL.....	78	MUSCLEHOOK GREEN.....	375
		MICRO-SCISSORS REDA.....	77, 78, 80	MUSCULE FORCEPS BERKE.....	389
		MICRO-SCISSORSBELLUCCI.....	417	MUSEUX HOOK FORCEPS.....	583
		MICROSURGICAL TISSUE FORCEPS.....	94	MYLES NOSE FORCEPS.....	427
		MICROSURGICAL TISSUE FORCEPS GOMEL.....	96	MYOMA A SCREW DOYEN.....	594
		MICROVASCULAR NEEDLE HOLDER.....	210	MYOMA KNIVES SEGOND.....	594
		MIDDELDORPF RETRACTOR.....	160		
		MIDDLETON-JANSEN SEPTUM FORCEPS.....	430		
		MIKULICZ BOWEL CLAMP.....	543		
MAGILL CATETHER INTRODUCING FORCEPS.....	28				
MAIER DRESSINGFORCEPS.....	134				
MALTZ (COTTLE) NOSE RASP.....	444				
MALTZ NOSE RASP.....	443				
MANDIBULAR BODY RETRACTOR HARGIS.....	463/6				
MANDRIN FOR TOURNIQUET.....	528				
MANOMETER.....	295, 596				
MARKERSCONNIN-AMSLER.....	380				
MARQUARD BONE RONGEUR.....	239				
MARSHIK TONSIL FORCEPS.....	468				
MARTEL GRASPING FORCEPS.....	110				
MARTIN BONE HOLDING FORCEPS.....	246				
MARTIN CARTILAGE SCISSORS.....	65/1				
MARTIN PELVIMETER.....	605				
MARTIN RETRACTOR.....	175/1				
MARTIN UTERINE-PROBES.....	586				
MARTINI BONE CURETTES.....	257				
MASSING-NEIVERT NOSE HOOK.....	447/1				
MASSON NEEDLE HOLDER.....	210				
MASTIN MUSCLE CLAMP.....	479				
MATHIEU FOREIGN-BODY FORCEPS.....	553/1				
MATHIEU NEEDLE HOLDER.....	213				
MATHIEU RECTAL-SPECULA.....	560				
MATHIEU RETRACTOR.....	141				
MATHIEU-OLSEN NEEDLE HOLDER.....	212				
MATSON RASPARTORIES.....	279				
MATSON-ALEXANDER RASPARTORIES.....	279				
MAXI GRASPER BIOPSY FORCEPS.....	593				
MAYFIELD BONE RONGEUR.....	238				
MAYO DISSECTING SCISSORS.....	52				
MAYO GALL STONE CURETTE.....	534				
MAYO GALL STONE PROBES.....	534				
MAYO STERILIZATION CLAMP.....	227				
MAYO SUPERCUT SCISSORS.....	71				
MAYO TISSUE FORCEPS.....	89				
MAYO TONGUE DEPRESSORS.....	451				
MAYO-ADAMS RETRACTORS.....	171				
MAYO-BLAKE GALL STONE FORCEPS.....	531				
MAYO-COLLINS RETRACTOR.....	141				
MAYO-COLLINS RETRACTOR-SET.....	141				
MAYO-HABERISSER WIRE FORCEPS.....	319				
MAYO-HEGAR NEEDLE HOLDER.....	209				
MAYON-GUYON HEMOSTATIC CLAMP.....	122				
MAYO-NOBLE DISSECTING SCISSORS.....	52				
MAY-OPHTHALMOSKOP UNI.....	14				
MAYO-ROBSON BOWEL CLAMP.....	541				
MAYO-STILLE DISSECTING SCISSORS.....	52				
MAYO-STILLE SUPERCUT SCISSORS.....	71				
MC DONALD ELEVATOR.....	283				
MC GIVNEY HAEMORRHOIDAL LIGATOR.....	568				
MC INDOE BONE CUTTING FORCEPS.....	241				
MC KENZIE DRILL.....	299				
MCCULLOUGH STRABISMUS FORCEPS.....	385				
MCGEE HOOK.....	419				



N	NEEDLE YOUNG-BOOMERANG.....	220	NOVA SPHYGMOMANOMETER.....	6, 7	
NABATOFF VARICOSE VEIN PROBES.....	201	NEFF MENISCUS KNIVES.....	292	NOVAK BIOPSY CURETTE.....	587
NAEGELE OBSTETRICAL FORCEPS.....	602	NEGUS CHEST SUPPORT.....	459	NOYES EYESSCISSORS.....	75
NAGER RETRACTOR.....	465	NEIVERT NEEDLE HOLDER.....	208	NOYES POLYP FORCEPS.....	425
NAGER TONSIL NEEDLE.....	466	NEIVERT-ANDERSON CHISEL.....	442	NUCLEUS ROTATOR BECHERT.....	379
NAIL BRUSHES.....	611	NELATON PROBES.....	199	NYSTAGMUS SPECTACLES FRENZEL.....	20
NAIL DRILL.....	297	NELSON LIGATUREE NEEDLE.....	219		
NAIL FORCEPS.....	609, 613	NELSON STANDARD TROCAR.....	204	O	
NAIL FORCEPS ANVIL.....	613	NELSON TROCAR.....	205	OBDUKTIONS-BESTECK.....	269
NAIL FORCEPS RADOLF.....	297	NELSON VASCULARTISSUE FORCEPS.....	89	OBSTETRICAL CURETTE SELLHEIM.....	607
NAIL FORCEPS TURNBULL.....	609	NEONATAL VASCULAR CLAMP.....	523	OBSTETRICAL FORCEPS BARTON.....	603
NAIL IMPACTOR.....	322	NEONATAL VASCULAR CLAMP CASTANEDA.....	527	OBSTETRICAL FORCEPS BOERMA.....	604
NAIL NIPPERS.....	612/2, 613, 614	NERVE ENHOOK CUSHING.....	328	OBSTETRICAL FORCEPS DE LEE.....	602
NAIL RASP.....	610	NERVE HOOK CRILE.....	328	OBSTETRICAL FORCEPS ELLIOT.....	602
NAIL SCISSORS.....	609	NERVE HOOK DANDY.....	328	OBSTETRICAL FORCEPS KIELLAND.....	602
NAIL SET.....	609	NERVE HOOK GRAHAM.....	328	OBSTETRICAL FORCEPS KIELLAND-LUIKART.....	603
NAIL SKIN FORCEPS.....	613	NERVE HOOK HOLSHER.....	329	OBSTETRICAL FORCEPS LUIKART.....	603
NAIL SKIN FORCEPS.....	610, 613	NERVE HOOK KRAYENBUEHL.....	336	OBSTETRICAL FORCEPS MCLEAN.....	603
NAIL SPLITTING SCISSORS.....	614	NERVE HOOK LOVE.....	329	OBSTETRICAL FORCEPS MCLEAN-LUIKART.....	603
NAVELSTRINGCLAMP COLLIN.....	605	NERVE HOOK LOVE.....	330	OBSTETRICAL FORCEPS MCLEAN-TUCKER.....	603
NAVELSTRINGCLAMP KANE.....	605	NERVE HOOK SACHS.....	328	OBSTETRICAL FORCEPS MCLEAN-TUCKER-LUIKART.....	603
NEEDLE.....	222, 223	NERVE HOOK SCOVILLE.....	329, 330	OBSTETRICAL FORCEPS NAEGELE.....	602
NEEDLE BARBARA.....	419	NERVE HOOK SMITHWICK.....	328	OBSTETRICAL FORCEPS PIPER.....	604
NEEDLE ELECTRODE MONOPOLAR.....	628, 629	NEUGS TONSIL FORCEPS.....	467	OBSTETRICAL FORCEPS SIMPSON.....	602
NEEDLE GUIDE IOWA.....	206	NEUROSURGICAL SCISSOR STRULLY.....	65	OBSTETRICAL FORCEPS SIMPSON-BRAUN.....	602
NEEDLE HOLDER ADSON.....	211	NEUROSURGICAL SCISSORS.....	65	OBSTETRICAL FORCEPS SIMPSON-LUIKART.....	603
NEEDLE HOLDER ARRUGA.....	214	NEWS TRACHEA HOOK.....	477	OBSTETRICAL FORCEPS WRIGLEY.....	602
NEEDLE HOLDER BABY-OLSEN-HEG.....	212	NIPPERS NAIL.....	612/2, 613, 614	OBWEGESER AHLE.....	463
NEEDLE HOLDER BABY-WEBSTER.....	208	NISSEN FINE HEMOSTATIC CLAMP.....	113	OBWEGESER BLADE OSTEOTOME.....	464/1
NEEDLE HOLDER BARRAQUER.....	217	NISSEN HEMOSTATIC CLAMP.....	113	OBWEGESER RASPARTORIES.....	462
NEEDLE HOLDER BARRAQUER MICRO.....	216	NOISE APPARTUS POLITZER.....	405	OBWEGESER RETRACTOR.....	460, 461
NEEDLE HOLDER BAUMGARTNER.....	208	NORDFOLK-NORWICH RETRACTORS.....	172	OBWEGESER RETRACTORS.....	463
NEEDLE HOLDER BOYNTON.....	214	NORTHBENT SUTURE SCISSORS.....	66	OCHSNER TROCAR.....	205
NEEDLE HOLDER BOZEMANN.....	211	NOSE DRESSING FORCEPS LUBET-BARBON.....	424	O'CONNOR IRIS HOOK.....	375
NEEDLE HOLDER BROWN.....	209	NOSE DRESSING FORCEPS WESTMACOTT.....	424	OEHLER SURGICAL TISSUE FORCEPS.....	81/1
NEEDLE HOLDER CASTROVIEJO.....	215	NOSE FORCEPS CAPLAN.....	428	OLDBERG LAMINECTOMY RETRACTOR FORCEPS.....	347
NEEDLE HOLDER CASTROVIEJO.....	216	NOSE FORCEPS HARTMANN.....	427	OLIVECRONA BONE RONGEUR.....	231
NEEDLE HOLDER CASTROVIEJO MICRO.....	215	NOSE FORCEPS MYLES.....	427	OLIVECRONA BRAINSPATULA.....	336
NEEDLE HOLDER CHEEKSTEEN.....	210	NOSE FORCEPS SCHMEDEN.....	427	OLIVECRONA DURA DISSECTOR.....	332
NEEDLE HOLDER COLLIER 125CM.....	208	NOSE FORCEPS TAKAHASHI.....	427	OLIVECRONA WIRESAW.....	332
NEEDLE HOLDER CRILE.....	213	NOSE FORCEPS WATSON-WILLIAMS.....	428	OLIVECRONA-TOENNIS (SCOVILLE).....	326
NEEDLE HOLDER CRILE-MURRAY.....	209	NOSE FORCEPS WEIL-BLAKESLEY.....	426	OLIVECRONA-TOENNIS APPLIERFORCEPS.....	326
NEEDLE HOLDER CRILE-WOOD TC.....	209	NOSE FORCEPSSTRUYCKEN.....	427	OLLIER RETRACTOR.....	162
NEEDLE HOLDER DE BAKEY.....	210	NOSE HOOK AUFRICHT.....	447	OLSEN-HEGAR NEEDLE HOLDER.....	212
NEEDLE HOLDER DERF.....	208	NOSE HOOK CONVERSE.....	448	OMBREDANNE HAMMER.....	273
NEEDLE HOLDER FINOCCHIETTO.....	211	NOSE HOOK COTTLE.....	447, 447/1	OPHTHALMOSKOP MAY UNI II.....	14
NEEDLE HOLDER GILLIES.....	212	NOSE HOOK HOOK.....	447	OP-LARYNGOSKOP HOLINGER.....	37
NEEDLE HOLDER HALSEY.....	208	NOSE HOOK LANGE.....	448	OP-LARYNGOSKOP JACKSON.....	37
NEEDLE HOLDER HALSEY.....	208	NOSE HOOK MASING-NEIVERT.....	447	OP-LARYNGOSKOP KLEINSASSER.....	35
NEEDLE HOLDER HEANEY.....	210	NOSE RASP FOMON.....	444, 445	OPHTHALMOLOGIC SCISSORS.....	57, 58
NEEDLE HOLDER HOESSEL.....	213	NOSE RASP JOSEPH.....	443	OPHTHALMOLOGIC SCISSORS AEBLI.....	58
NEEDLE HOLDER JACOBSON.....	215	NOSE RASP JOSEPH (LEWIS).....	443	OPHTHALMOLOGIC SCISSORS GRADLE.....	57
NEEDLE HOLDER JOHNSON.....	211	NOSE RASP MALTZ.....	443	OPHTHALMOLOGIC SCISSORSSTEVENS.....	58
NEEDLE HOLDER KALT-ARRUGA.....	214	NOSE RASP MALTZ (COTTLE).....	444	OSCILLATION PLASTER CAST SAW.....	230
NEEDLE HOLDER KILNER.....	212	NOSE RASP MILLER.....	444	OSTEOTOME BLADE OBWEGESER.....	464/1
NEEDLE HOLDER LANGENBECK.....	213	NOSE RASP PEET.....	446	OSTEOTOME EPKER.....	464/2
NEEDLE HOLDER LICHTENBERG.....	213	NOSE RASP WIENER.....	443	OSTROEM ANTRUM-PUNCH.....	430
NEEDLE HOLDER MASSON.....	210	NOSE SCISSORS.....	429	O'SULLIVAN-O'CONNOR ABDOMINALDECKEN.....	181
NEEDLE HOLDER MATHIEU.....	213	NOSE SCISSORS COTTLE.....	59	O'SULLIVAN-O'CONNOR ABDOMINALRETRACTORS.....	181
NEEDLE HOLDER MATHIEU-OLSEN.....	212	NOSE SCISSORS FOMON.....	58	O'SULLIVAN-O'CONNOR SP.....	576
NEEDLE HOLDER MAYO-HEGAR.....	209	NOSE SCISSORS HEYMANN.....	58	OTIS URETHROTOME.....	553
NEEDLE HOLDER METZENBAUM.....	211	NOSE SPECULA COTTLE.....	423	OTOSKOPE DIAGNOSTIC SET UNI I.....	13
NEEDLE HOLDER MICROVASCULAR.....	210	NOSE SPECULA HARTMANN.....	422	OVAL RING.....	194
NEEDLE HOLDER NEIVERT.....	208	NOSE SPECULA HARTMANN-HALLE.....	421	OVERHOLT HEMOSTATIC CLAMP.....	114
NEEDLE HOLDER OLSEN-HEGAR.....	212	NOSE SPECULA KILLIAN.....	423	OVERHOLT-BABY HEMOSTATIC CLAMP.....	114
NEEDLE HOLDER RYDER.....	210	NOSE SPECULA REDA.....	423	OVERHOLT-GEISENDOERFER HEMOSTATIC CLAMP.....	114
NEEDLE HOLDER SAROT.....	211	NOSE SPECULA THUDICHUM.....	421	OVERHOLT-MIXTER HEMOSTATIC CLAMP.....	115
NEEDLE HOLDER STEVENS.....	214	NOSE SPECULA TIECK-HALLE.....	423	OVUM CURETTE CUZZI.....	606
NEEDLE HOLDER STRATTE.....	212	NOSE SPECULA TYPE VIENNA.....	421	OVUM CURETTE PESTALOZZA.....	606
NEEDLE HOLDER WEBSTER.....	208	NOSE SPECULA VOLTOLINI.....	421	OVUM CURETTE WALLICH.....	607
NEEDLE REVERDIN.....	220	NOSEOLIVE POLITZER.....	406	OVUM FORCEPS SAENGER.....	606
NEEDLE ROSEN.....	419	NOSESAW JOSEPH.....	446	OVUM FORCEPS WINTER.....	606
NEEDLE STERILIZATION CASE.....	615	NOTO UTERINE POLYP FORCEPS.....	585		



**P**

PAN BED .....621  
 PAN PLACENTA .....621  
 PARACENTESIS NEEDLE LUCAE .....408  
 PARACENTESIS NEEDLE POLITZER .....408  
 PARAMETRIUM SCISSORS .....63  
 PARK EYE SPECULA .....371  
 PARKER RETRACTOR .....139  
 PARTSCH CHISELS .....259  
 PARTSCH HAMMER .....271  
 PASSOW CHISELS .....260  
 PATELLA FORCEPS .....248  
 PATON CORNEAL DISSECTOR .....373  
 PAUFIQUE KERATOPLAST-KNIVES .....373  
 PAUFIQUE TISSUE FORCEPS .....392  
 PAYR BOWEL CLAMP .....548  
 PAYR GUIDE PROBES .....221  
 PEAN HEMOSTATIC CLAMP .....108  
 PEAN HEMOSTATIC CLAMP .....110  
 PEAN HEMOSTATIC CLAMP .....108, 110  
 PECK-JOSEPH DISSECTINGSCISSORS .....74  
 PEDERSON VAGINAL SPECULA .....570  
 PEENFIELD DISSECTOR .....333  
 PEERS TOWEL CLAMP .....132  
 PEET NOSE RASP .....446  
 PEET SPLINTER FORCEPS .....92  
 PELVIMETER COLLIER .....605  
 PELVIMETER MARTIN .....605  
 PELVIS-HOOK ST.MARKS .....165  
 PENISCLAMP STOCKMANN .....553/1  
 PENISCLAMP STRAUSS .....553/1  
 PENNINGTON HEMOSTATIC CLAMP .....109  
 PENNINGTON SEPTUM ELEVATOR .....438  
 PERCUSSION HAMMER BABINSKY .....24  
 PERCUSSION HAMMER BERLINER .....24  
 PERCUSSION HAMMER BUCK .....24  
 PERCUSSION HAMMER TAYLOR .....24  
 PERCUSSION HAMMER TROEMNER .....24  
 PERCY REKTOR .....296  
 PERFORATORS SMELLIE .....607  
 PERIPHERAL-VASCULAR CLAMP DE BAKEY .....494  
 PERIPHERAL-VASCULAR CLAMP LELAND-JONES .....494  
 PERITONEUMCLAMP FAURE .....123  
 PERITONEUMCLAMP MIKULICZ .....123  
 PERITONEUMCLAMP MIKULICZ-BABY .....123  
 PERITONEUMCLAMP PHANEUF .....123  
 PERKINS RETRACTORS .....168  
 PERTHES AWL .....304  
 PESTALOZZA OVUM CURETTE .....606  
 PETRI BOX .....620  
 PETZ STOMACH AND BOWEL SUTUREING APPARATUS .....549  
 PHALANGEN KNIVES .....44  
 PHANEUF PERITONEUM CLAMP .....123  
 PIERCE SEPTUM .....438  
 PIERCE TROCAR .....204  
 PIFFARD LUPUS CURETTE .....608  
 PILLING CLIP FORCEPS .....524  
 PIN CUTTER .....320  
 PINARD STETHOSCOPE .....23  
 PINWHEEL WARTENBERG .....25  
 PIPER OBSTETRICAL FORCEPS .....604  
 PISTOL FOR CLEANING .....626  
 PLACENTA PAN .....621  
 PLASTER CAST SAW ELEKTRISCH .....230  
 PLASTER CAST SAW ENGEL .....229  
 PLASTER FORCEPS WOLFF .....233  
 PLASTER KNIVES ESMARCH .....233  
 PLASTER KNIVES HOPKINS .....233  
 PLASTER KNIVES REINER .....233  
 PLASTER KNIVES WIGMORE .....229  
 PLASTER RETRACTOR BEESON .....232  
 PLASTER RETRACTOR HAGLUND-STILLE .....232

PLASTER RETRACTOR HENNIG .....232  
 PLASTER RETRACTOR REDA .....232  
 PLASTER VACUUM WITH OSCILLATING PLASTER SAW .....231  
 PLASTERSCISSORSSTILLE .....229  
 PLASTIK-HAMMER .....271  
 PLATTE JAEGER .....371  
 PLEKMANN DRESSING FORCEPS .....137  
 PLESTER KNIVES .....418  
 PLESTER RETRACTORS .....171  
 PLESTER SUCTION TUBE .....338  
 PNEUMATIC TOURNIQUE .....295  
 POLITZER AIR BLOWER .....406  
 POLITZER EAR KNIVES .....408  
 POLITZER EAR SPECULA .....399  
 POLITZER NOSEOLIVE .....406  
 POLITZER PARACENTESIS NEEDLE .....408  
 POLYP FORCEPS HARTMANN .....424  
 POLYP FORCEPS LITTAUER .....425  
 POLYP FORCEPS NOYES .....425  
 POLYP LOOP .....411  
 POLYP SNARE KRAUSE .....433/2  
 POLYP SNARE KRAUSE .....411, 434  
 POLYP SNARE KRAUSE-VOSS .....433/2  
 POLYP SNARE WILDE .....433/2  
 POLYP SNARE WILDE .....411, 434  
 POOLE SUCTION TUBE .....27  
 POST MORTEM .....268  
 POST MORTEM KNIVES .....48  
 POST MORTEM KNIVES VIRCHOW .....48  
 POTTS SMITH SURGICAL TISSUE FORCEPS .....81  
 POTTS-DE MARTEL VASCULARSCISSORS .....59  
 POTTS-SMITH ANATOMIC TISSUE FORCEPS .....81  
 POTTS-SMITH VASCULAR SCISSORS .....61  
 PRATT FISTULA PROBES .....563  
 PRATT GRASPING FORCEPS .....110  
 PRATT HOOK FORCEPS .....584  
 PRATT RECTAL-SPECULA .....559  
 PRATT UTERINE DILATATOR .....580  
 PRECISA SPHYGMOMANOMETER .....9  
 PRICE-THOMAS BRONCHUS CLAMP .....490  
 PRINCE MUSCLE FORCEPS .....387  
 PRINCE TONSIL SCISSORS .....59  
 PROBE AND PACKER .....612  
 PROBE TIPS .....201  
 PROBES BRODIE .....199  
 PROBES DOYEN .....199  
 PROBES FISH .....199  
 PROBES HARMS .....333  
 PROBES KOCHER .....479  
 PROBES NELATON .....199  
 PROBES VALLEIX .....586  
 PROBES WATSON-CHEYNE .....199  
 PROBES WORST .....333  
 PROCTOSCOPE BENSAUDE .....565  
 PROCTOSCOPE CHELSEA-EATON .....563  
 PROCTOSCOPE FANSLER .....564  
 PROCTOSCOPE KELLY .....562, 563  
 PROCTOSCOPE MORGAN .....565  
 PROSTATIC GRASPING FORCEPS MILLIN .....551  
 PROSTATIC HOOK YOUNG .....550  
 PROVIDENCE-HOSPITAL HEMOSTATIC CLAMP .....106  
 PUNCH KEYES .....608  
 PUNCTION CANNULA FRAZIER .....337  
 PUNCTION CANNULA LICHTWITZ .....433  
 PUNCTION CANNULA QUINKE .....206  
 PUTTI BONE RASP .....294  
 PYLORUSRETRACTOR BENSON .....544

**Q**

QUERVAIN ELEVATOR .....275  
 QUICK HANDLE .....301  
 QUINBY GUM SCISSORS .....67  
 QUINKE PUNCTION CANNULA .....206  
 QUIRE FOREIGN-BODY LEVER .....412  
 QUISLING HAMMER .....271

**R**

RACHIOTOM .....267  
 RADOLF NAIL FORCEPS .....297  
 RALK BONE HAND DRILLS .....300  
 RAMPLEY DRESSING FORCEPS .....136  
 RAMUS RETRACTOR .....461  
 RANDALL BIOPSY CURETTE .....587  
 RANDALL KIDNEY STONE FORCEPS .....535  
 RANEY APPLING FORCEPS .....327  
 RANGELL RETRACTOR .....140  
 RASPTORIES .....279  
 RASPTORIES ADSON .....282  
 RASPTORIES ALEXANDER .....276  
 RASPTORIES COBB .....280  
 RASPTORIES DINGMANN .....463, 463/3  
 RASPTORIES DOYEN .....278  
 RASPTORIES FARABEUF .....274  
 RASPTORIES FARABEUF-COLLIN .....274  
 RASPTORIES FOMON .....277  
 RASPTORIES JOSEPH .....277  
 RASPTORIES KOENIG .....276  
 RASPTORIES LAMBOTTE .....274  
 RASPTORIES LANGENBECK .....275  
 RASPTORIES MATSON .....279  
 RASPTORIES MATSON-ALEXANDER .....279  
 RASPTORIES OBWEGESER .....462  
 RASPTORIES SEMB .....278  
 RASPTORIES WILLIGER .....276  
 RASPTORIESIUM MOLT .....276  
 RASPTORIESIUM WIBERG .....277  
 RASPTORIESSEDILLOT .....274, 275  
 RASPTORY HARGIS .....463/2  
 RASPTORY SELDING .....277  
 RAZOR BLADES .....45  
 REAMER KUENTSCHER .....321  
 RECAMIER UTERINE CURETTE .....597  
 RECTAL BIOPSY FORCEPS TURREL .....567  
 RECTAL SUCTION TUBE BUJE .....566  
 RECTALBIOPSY FORCEPS YEOMAN .....566, 567  
 RECTALSNARE WESTON .....566  
 RECTAL-SPECULA ALAN-PARKS .....561  
 RECTAL-SPECULA BARR .....559  
 RECTAL-SPECULA BODENHAMMER .....559  
 RECTAL-SPECULA CZERNY .....559  
 RECTAL-SPECULA HILL-FERGUSON .....560  
 RECTAL-SPECULA MATHIEU .....560  
 RECTAL-SPECULA PRATT .....559  
 RECTAL-SPECULA SAWYER .....560  
 RECTAL-SPECULA SCHULZE-BERG .....560  
 RECTAL-SPECULA SIMS .....559  
 RECTUM-ANAST.KL. HAYES .....545  
 REDA TUNING FORC .....403  
 REDA AMPUTATION KNIVES .....44  
 REDA BLADEBREAKER .....45  
 REDA BONE CURETTES .....256  
 REDA BONE HAND DRILLS .....300  
 REDA BONE HOLDING FORCEPS .....246, 247  
 REDA BOWEL GRASPING FORCEPS ATRAUMA .....111  
 REDA CILIA FORCEPS .....395  
 REDA COTTON-APPLICATOR .....203  
 REDA EXCENTER BANDAGE SCISSORS .....69/2  
 REDA EYE MAGNET .....395  
 REDA FINGER RING SAW .....297  
 REDA NOSE SPECULA .....423  
 REDA PLASTER RETRACTOR .....232



REDA SICKLE KNIVES.....	435	RETRACTOR MORRIS.....	164	RIB SPREADER HAIGHT.....	487
REDA SKIN HOOK.....	150	RETRACTOR MURPHY.....	156	RIB SPREADER MORSE.....	484
REDA STERILIZATION FORCEPS.....	615	RETRACTOR NAGER.....	465	RIB SPREADER MORSE-FAVALORO.....	484
REDA SUTURE FORC.....	221	RETRACTOR OBWEGESER.....	460, 461	RIB SPREADER RIENHOFF-FINOCCHIETTO.....	486
REDON GUIDE NEEDLE.....	207	RETRACTOR OLLIER.....	162	RIB SPREADER TUFFIER.....	487
REES FACE LIFT SCISSORS.....	73	RETRACTOR PARKER.....	139	RIB SPREADERBAILEY-GIBBON.....	489
REICHERT DECKEL EPIGLOTTIS RETRACTOR.....	471	RETRACTOR RAGNELL.....	140	RIBBON BOWEL SPATULA.....	143
REILL BONE HOLDING FORCEPS.....	248	RETRACTOR RAMUS.....	461	RICARD ABDOMINAL RETRACTORS.....	191
REINER EAR SYRINGE.....	406	RETRACTOR RICHARDSON.....	142	RICHARDSON RETRACTOR.....	142
REINER PLASTER KNIVES.....	233	RETRACTOR RICHARDSON GRIP.....	142	RICHARDSON-EASTMAN RETRACTOR.....	142
REKORDSYRINGE.....	596	RETRACTOR RICHARDSON-EASTMAN.....	142	RICHARDSON-GRIP RETRACTOR.....	142
RESANO BOWEL CLAMP.....	542	RETRACTOR ROSE.....	140	RICHNAU-HOLMGREN EAR SPECULA.....	400
RESANO CAPSULA SCISSORS.....	53/2	RETRACTOR ROUX.....	139	RICHTER-HEATH CLIP FORCEPS.....	224
RESECTION KNIVES.....	47	RETRACTOR ROUX-BABY.....	140	RIENHOFF-FINOCCHIETTO RIB SPREADER.....	486
RETRACTOR ALM.....	168	RETRACTOR ROUX-MINI.....	140	RIGBY ABDOMINAL RETRACTORS.....	189/2
RETRACTOR ANDERSON.....	198	RETRACTOR SAUERBRUCH.....	164	RI-MINI DIAGNOSTIC SET.....	17
RETRACTOR ASSEMBLY.....	188	RETRACTOR SAUERBRUCH.....	164, 166	RING OVAL.....	194
RETRACTOR AUFFRANC.....	289	RETRACTOR SENN-GREEN.....	153	RING ROUND.....	194
RETRACTOR BREAST.....	198	RETRACTOR SENN-MILLER.....	143	RING SEGMENT.....	194
RETRACTOR BRUNNER.....	167	RETRACTOR SIMON.....	164	RING TONGUE DEPRESSORS.....	455
RETRACTOR COLLIN.....	139	RETRACTOR SPINA-NASALIS.....	461	RINGS LIGATURE.....	568
RETRACTOR COLLIN HARTMANN.....	141	RETRACTOR TEBBETTS.....	197	RITTER-HALLE IRRIGATION CANNULA.....	433
RETRACTOR COOLEY.....	148	RETRACTOR TESSIER.....	463/3	ROBB SPATULA.....	530
RETRACTOR CORONAL BROW.....	198	RETRACTOR TUFFIER.....	147	ROBERTS HEMOSTATIC CLAMP.....	117
RETRACTOR CORYLLOS.....	166	RETRACTOR US-ARMY PARKER-LANG.....	141	ROCHARD ABDOMINAL RETRACTORS.....	186
RETRACTOR CRILE.....	140	RETRACTOR VOLKMANN.....	153	ROCHESTER-CARMALT HEMOSTATIC CLAMP.....	109
RETRACTOR CUSHING.....	151	RETRACTOR VOLKMANN.....	156	ROCHESTER-OCHSNER HEMOSTATIC CLAMP.....	108
RETRACTOR DAVIDSON (SCAPULA).....	166	RETRACTOR YANCOSKIE.....	198	ROCHESTER-PEAN HEMOSTATIC CLAMP.....	108
RETRACTOR DEAVER.....	145	RETRACTOR ZENKER.....	161	ROEDER TOWEL CLAMP.....	132
RETRACTOR DEAVER GRIP.....	146	RETRACTORS ADSON.....	173	ROGER SEPTUM.....	437
RETRACTOR DEBAKEY.....	189/1	RETRACTORS ADSON.....	172, 173, 174	ROGERS HYSTERECTOMY CLAMP.....	127
RETRACTOR DELEE.....	574	RETRACTORS ANDERSON-ADSON.....	172	ROGGE STERILIZATION FORCEPS.....	227
RETRACTOR DESMARRS.....	151	RETRACTORS BECKMANN.....	176	ROLLET EXTIRPATION CHISELS.....	374
RETRACTOR DESMARRS.....	151	RETRACTORS BECKMANN-ADSON.....	175	ROLLET EXTRACTION HOOK.....	375
RETRACTOR DOYEN.....	163	RETRACTORS BECKMANN-EATON.....	176	RONGEUR CITELLI.....	430
RETRACTOR DOYEN-STILLE.....	167	RETRACTORS CASPAR.....	179, 180	RONGEUR FERRIS-SMITH-KERRISON.....	344, 344/2
RETRACTOR FARABEUF.....	139	RETRACTORS CLOWARD.....	178	RONGEUR HAJEK-KOFLER.....	429, 431
RETRACTOR FERRIERA.....	197	RETRACTORS DARLING.....	178	RONGEUR HOLTH.....	380
RETRACTOR FINSEN.....	168	RETRACTORS HENLEY.....	170	RONGEUR KERRISON.....	428
RETRACTOR FREEMAN.....	198	RETRACTORS MAYO-ADAMS.....	171	ROSE RETRACTOR.....	140
RETRACTOR FRITSCH.....	163	RETRACTORS MEYERDING.....	180	ROSEN KNIVES.....	418
RETRACTOR GIL-VERNET.....	152	RETRACTORS MOLLISON.....	171	ROSEN NEEDLE.....	419
RETRACTOR GOELET.....	141	RETRACTORS NORDFOLK-NORDWICH.....	172	ROSEN SUCTION TUBE.....	338
RETRACTOR GREEN.....	160	RETRACTORS PERKINS.....	168	ROSER-KOENIG.....	454
RETRACTOR HARRINGTON.....	147	RETRACTORS PLESTER.....	171	ROUND RING MEDIUM.....	194
RETRACTOR HARRINGTON-PEMBERTON.....	147	RETRACTORS PLESTER.....	171	ROUX MINI RETRACTOR.....	140
RETRACTOR HEANEY.....	164	RETRACTORS PLESTER.....	171	ROUX RETRACTOR.....	139
RETRACTOR HIBBS.....	164	RETRACTORS SCALP-CONTOUR.....	169	ROUX-BABY RETRACTOR.....	140
RETRACTOR HOESSEL.....	167	RETRACTORS TRAVERS.....	172	ROWE.....	459
RETRACTOR HOFER.....	465	RETRACTORS WEITLANER.....	169	RUBIN SEPTUM FORCEPS.....	428
RETRACTOR HOLZHEIMER.....	168	RETRACTORS WULLSTEIN.....	171	RUDD HAEMORRHOIDAL LIGATOR.....	568
RETRACTOR ISRAEL.....	162	RETRAKTOR PERCY.....	296	RUMEL HEMOSTATIC CLAMP.....	117
RETRACTOR JACKSON-BURROWS RETRACTOR.....	189/2	REVERDIN BOWEL SPATULA.....	143/1	RUMEL-BELMONT TOURNIQUET.....	528
RETRACTOR JANSEN.....	168	REVERDIN NEEDLE.....	220	RUSKIN BONE RONGEUR.....	239
RETRACTOR KELLY.....	164	REYNOLDS SUPERCUT SCISSORS.....	72	RUSKIN-LISTON BONE CUTTING FORCEPS.....	241
RETRACTOR KELLY GRIP.....	142	REYNOLDS SURGICAL SCISSORS.....	54	RUSS MODELL GRASPING TISSUE FORCEPS.....	85
RETRACTOR KLAPP.....	150	RHINOPLASTIKSCISSORS FOMON.....	65/1	RUSSEL-DAVIS.....	458
RETRACTOR KOCHER.....	155	RIB SCISSORS.....	480	RYDEL-SEIFFERT TUNING FORC.....	404
RETRACTOR KOCHER.....	160, 163	RIB SCISSORS BETHUNE.....	481	RYDER NEEDLE HOLDER.....	210
RETRACTOR KOCHER-LANGENBECK.....	159	RIB SCISSORS BRUNNER.....	481		
RETRACTOR KOERTE.....	162	RIB SCISSORS CORYLLOS.....	480		
RETRACTOR KONIG.....	153	RIB SCISSORS GIERTZ-STILLE.....	481		
RETRACTOR LAHEY.....	157	RIB SCISSORS GLUCK.....	480		
RETRACTOR LANGENBECK.....	158, 159	RIB SCISSORS SAUERBRUCH.....	481		
RETRACTOR LANGENBECK-GREEN.....	153	RIB SCISSORS SAUERBRUCH-FREY.....	481		
RETRACTOR LITTLE.....	157	RIB SCISSORSSTILLE.....	480		
RETRACTOR LOVE.....	465	RIB SPREADER BAILEY.....	489		
RETRACTOR MARTIN.....	175/1	RIB SPREADER BAILEY-BABY.....	489		
RETRACTOR MATHIEU.....	141	RIB SPREADER COOLEY.....	487		
RETRACTOR MEYERDING.....	157, 177	RIB SPREADER COOLEY-NEONATAL.....	485		
RETRACTOR MEYERDING.....	177	RIB SPREADER DE BOER.....	486		
RETRACTOR MIDDELDORPF.....	160	RIB SPREADER FINOCCHIETTO.....	482, 484		
RETRACTOR MIKULICZ.....	163	RIB SPREADER FINOCCHIETTO-BURFORD.....	483		

S

SAALFELD COMEDONE EXTRACTOR.....	608
SACHS DURA DISSECTOR.....	332
SACHS NERVE HOOK.....	328
SAENGER OVUM FORCEPS.....	606
SAGITTAL SPLIT RETRACTOR SMITH.....	463/5
SALPINGOGRAPHSCHULTZE.....	596
SANVENERO SURGICAL SCISSORS.....	54
SAROT HEMOSTATIC CLAMP.....	118
SAROT NEEDLE HOLDER.....	211
SATINSKY TANGENTIAL CLAMP.....	502
SATINSKY VASCULAR SCISSORS.....	65/1
SATINSKY VASCULARSCLAMP.....	491

SATO CORNEAL SCARIFIER.....	373	SCOVILLE NERVE HOOK.....	329, 330	SIEBENMANN IRRIGATION CANNULA.....	433/1
SATTERLEE AMPUTATION SAW.....	296	SCOVILLE-HAVERFIELD LAMINECTOMY		SIEBOLD GYNECOLOGICAL SCISSORS.....	62
SAUERBRUCH BONE RONGEUR.....	240	RETRACTORRETRACTOR.....	196	SIEGLE EAR SPECULA.....	402
SAUERBRUCH RETRACTOR.....	164	SCREW DRIVER.....	232	SILICONMATT.....	616
SAUERBRUCH RETRACTOR.....	164, 166	SCREW DRIVER LANE.....	323	SILVER DERMATOM.....	50
SAUERBRUCH RIB SCISSORS.....	481	SCREW DRIVER WILLIAMS.....	323	SILVER SEPTUM CHISELS.....	442
SAUERBRUCH WASTEFORCEPS.....	227	SCREW HOLDING SLEEVE.....	324	SILVERCLAMP.....	326
SAUERBRUCH-FREY STERNUM SCISSORS.....	481	SCUDDER BOWEL CLAMP.....	541	SIMCOE IRRIGATION CANNULA.....	394/2
SAW BLADES FOR AUTOPSY SAW.....	231/2	SEBLEAU ELEVATOR.....	275	SIMON RETRACTOR.....	164
SAW GIGLI.....	332	SECTION NEEDLE.....	268	SIMON UTERINE CURETTE.....	594
SAWTELL TONSIL FORCEPS.....	467	SEDILOT RASPARTORIES.....	274	SIMPLEX TUBING CLAMP.....	624
SAWYER RECTAL SPECULA.....	560	SEGMENTED RING.....	194	SIMPSON OBSTETRICAL FORCEPS.....	602
SAYRE ELEVATOR.....	281	SEGOND HYSTERECTOMYCLAMP.....	125	SIMPSON-BRAUN OBSTETRICAL FORCEPS.....	602
SCAGLIETTI BONE RONGEUR.....	240	SEGOND MYOMA KNIVES.....	594	SIMPSON-LUIKART OBSTETRICAL FORCEPS.....	603
SCALP-CONTOUR RETRACTORS.....	169	SEGOND-LANDAU HYSTERECTOMYCLAMP.....	125	SIMS GYNECOLOGICAL SCISSORS.....	62
SCALPEL.....	46	SEIFERT INTERCHANGEABLE TIPS.....	472	SIMS RECTAL-SPECULA.....	559
SCALPEL MINI.....	41	SELDIN RASPARTORY.....	277	SIMS UTERINE CURETTE.....	597
SCALPEL STERILE.....	43	SELLHEIM OBSTETRICAL CURETTE.....	607	SIMS UTERINE DILATOR.....	581
SCALPEL-BLADE.....	42	SEMB BONE CUTTING FORCEPS.....	242	SIMS UTERINE-DEPRESSOR.....	586
SCALPELBLADE REMOVER.....	42	SEMB BONE HOLDING FORCEPS.....	243	SIMS UTERINE-PROBES.....	586
SCALPEL-HANDLE.....	38, 39, 39/1, 39/2, 40, 42	SEMB BONE RONGEUR.....	240	SIMS VAGINAL SPECULA.....	573
SCALPEL-HANDLE COLLIN.....	40	SEMB BRONCHUSCLAMP.....	491	SIMS-MAIER DRESSINGFORCEPS.....	134
SCALPELHANDLE MINI.....	41	SEMB RASPARTORIES.....	278	SINGLEY TISSUE FORCEPS.....	88
SCHAEDEL TOWEL CLAMP.....	132	SEMKEN ANATOMIC TISSUE FORCEPS.....	86	SINSKEY HOOK.....	376
SCHAMBERG COMEDONE EXTRACTOR.....	608	SEMKEN SURGICAL TISSUE FORCEPS.....	86	SINUS SEPTUM ELEVATOR.....	438
SCHEDI BONE CURETTES.....	251	SEMM VAGINAL SPECULA.....	571	SINUSCOPY FORCEPS.....	431
SCHIEE GONIOTOMY KNIVES.....	373	SENN-GREEN RETRACTOR.....	153	SINUSCOPY-TROCAR.....	205
SCHIEINMANN INTERCHANGEABLE TIPS.....	472	SENN-MILLER RETRACTOR.....	143	SINUS-PROBES.....	438
SCHERBAK VAGINAL SPECULA.....	575	SEPTUM CANNULA.....	406	SISIMPACTION FORCEPS ROWE.....	459
SCHINK DERMATOME.....	49	SEPTUM CHISELS CINELLI.....	441	SKENE HOOK FORCEPS.....	582
SCHIOETZ TONOMETER.....	394/2	SEPTUM CHISELS COTTLE.....	440	SKIN HOOK COTTLE.....	447, 448
SCHLESINGER LAMINECTOMY RETRACTOR FORCEPS		SEPTUM CHISELS FOMON.....	441	SKIN HOOK COTTLE-NEVERT.....	448
.....	342	SEPTUM CHISELS FREER.....	439	SKIN HOOK FOMON.....	447/1
SCHMEDEN NOSE FORCEPS.....	427	SEPTUM CHISELS SHEEHAN.....	441	SKIN HOOK FRAZIER.....	149
SCHMID VASCULAR-IRRIGATION CANNULA.....	338	SEPTUM CHISELS SILVER.....	442	SKIN HOOK FREER.....	448
SCHMIEDEN GUIDEPROBES.....	221	SEPTUM ELEVATOR BALLENGER.....	439	SKIN HOOK GILLIES.....	448
SCHMIEDEN-DICK LIGATUREE NEEDLE.....	219, 221	SEPTUM ELEVATOR COTTLE.....	439	SKIN HOOK GRAEFE.....	149
SCHMIEDEN-TAYLOR DURASCISSORS.....	65/1	SEPTUM ELEVATOR COTTLE-JOSEPH.....	439	SKIN HOOK GUTHRIE.....	149
SCHNIDT TONSIL FORCEPS.....	467	SEPTUM ELEVATOR FREER.....	437	SKIN HOOK JOSEPH.....	149
SCHOENBORN THYROID GLAND HOOK.....	479	SEPTUM ELEVATOR HAJEK-BALLENGER.....	439	SKIN HOOK KILNER.....	608
SCHRÖDER HOOK FORCEPS.....	583, 584	SEPTUM ELEVATOR HALLE.....	437	SKIN HOOK KLEINERT-KUTZ.....	149
SCHRÖDER UTERINE CURETTE.....	595	SEPTUM ELEVATOR HOWARTH.....	438	SKIN HOOK REDA.....	150
SCHROEDER(POZZI) HOOK FORCEPS.....	582	SEPTUM ELEVATOR JOSEPH.....	437	SKIN SCISSORS.....	610
SCHUBERT BIOPSY FORCEPS.....	588	SEPTUM ELEVATOR KILLIAN.....	438	SKIN STRAIGHTENING BLADE FOR DERMATOME.....	49
SCHUKNECHT KNIVES.....	418	SEPTUM ELEVATOR MCKENTY.....	437, 438	SKIN-PUNCH KEYE.....	608
SCHULTZE SALPINGOGRAPH.....	596	SEPTUM ELEVATOR PENNINGTON.....	438	SKIN-PUNCH KEYE.....	608
SCHULZE-BERGMANN RECTAL-SPECULA.....	560	SEPTUM ELEVATOR PIERCE.....	438	SKLEROTOM GUYTON-LUNDGAARD.....	373
SCHUMACHER BIOPSY FORCEPS.....	588, 589	SEPTUM ELEVATOR ROGER.....	437	SKLEROTOM LUNDGAARD.....	373
SCHUMACHER EPISOTOMY SCISSORS.....	64	SEPTUM FORCEPS BRUENINGS.....	425	SLS CLIP FORCEPS.....	524
SCHUMACHER INTERCHANGEABLE TIPS.....	472	SEPTUM FORCEPS HEYMANN.....	425	SLUDER-BALLENGER.....	470
SCHUMACHER STERNUM SCISSORS.....	481	SEPTUM FORCEPS KNIGHT.....	425	SMELLIE HOOK.....	605
SCHWEIGGER CAPSULAR FORCEPS.....	391	SEPTUM FORCEPS LUC.....	426	SMELLIE PERFORATORS.....	607
SCISSORS CASTROVIEJO.....	79	SEPTUM FORCEPS MIDDLETON-JANSEN.....	430	SMILLIE BONE LEVERS.....	291
SCISSORS COTTLE.....	56	SEPTUM FORCEPS RUBIN.....	428	SMILLIE MENISCUSKNIVES.....	292
SCISSORS DOYEN.....	63	SEPTUM GOUGES FREER.....	442/1	SMITH EYE SPECULA.....	370
SCISSORS ENTEROTOMY.....	66	SEPTUM GOUGES HAJEK.....	442/1	SMITH SAGITTAL SPLIT RETRACTOR.....	463/5
SCISSORS ENUCLEATION.....	58	SEPTUM GOUGES KILLIAN-CLAUS.....	442/1	SMITH US ARMY BANDAGE SCISSORS.....	69/1
SCISSORS GORNEY.....	73	SEPTUM KNIVES CONVERSE.....	435	SMITH-BUIE ANAL RETRACTOR.....	561
SCISSORS GRAEFE.....	56	SEPTUM KNIVES COTTLE.....	435	SMITH-PETERSEN.....	261
SCISSORS HEPP-SCHIEDL.....	78	SEPTUM KNIVES FREER.....	434	SMITH-PETERSEN BONE RONGEUR.....	238
SCISSORS MARTIN CARTILAGE.....	65/1	SEPTUM KNIVES JOSEPH.....	434, 435	SMITHWICK APPLIERSFORCEPS.....	326
SCISSORS MICRO.....	76	SEPTUM SCISSORS KILLIAN.....	471	SMITHWICK NERVE HOOK.....	328
SCISSORS NEUROSURGICAL.....	65	SEPTUM STRAIGHTENING FORCEPS ASCH.....	449	SNELLEN CATARACT LOOP.....	378
SCISSORS PARAMETRIUM.....	63	SEPTUM STRAIGHTENING FORCEPS WALSHAM.....	449	SNELLEN ENTROPIONUM FORCEPS.....	393
SCISSORS REES.....	73	SERPENTINE BIOPSY FORCEPS.....	593	SOMER UTERINE-GRASPING FORCEPS.....	585
SCISSORS SIEBOLD.....	62	SEUTIN BANDAGE SCISSORS.....	69/2	SPAREBLADE.....	49
SCISSORS SIMS.....	62	SEXTON EAR KNIVES.....	408	SPAREBLADE STERILE.....	50
SCISSORS THOREK.....	65/2	SHAPLEIGH EAR LOOP.....	410	SPATULA.....	203, 612
SCISSORS WAGNER.....	67	SHAVER KNIVES.....	49	SPATULA AND PACKER.....	612
SCISSORS WERTHEIM.....	63	SHEA MICRO-EAR SCISSORS.....	413	SPATULA HIRSCHMAN.....	379
SCOVILLE BONE CURETTE.....	253	SHEEHAN CHISELS.....	441	SPECULA FRIEDMANN.....	577
SCOVILLE HOOK.....	196	SHEETS EYE CANNULA.....	394/2	SPECULA KALLMORGEN.....	573
SCOVILLE LAMINECTOMY RETRACTORRETRACTOR.....	196	SICKLE KNIVES REDA.....	435	SPECULA KRISTELLER.....	572





SPECULA O'SULLIVAN-O'CONNOR .....576  
 SPENCER SUTURE SCISSORS .....66  
 SPENCER-WELLS HEMOSTATIC CLAMP .....109  
 SPHYGMOMANOMETER BABYPHON .....10  
 SPHYGMOMANOMETER DIPLOMAT .....5  
 SPHYGMOMANOMETER EXACTA .....8  
 SPHYGMOMANOMETER MINIMUS .....11, 12  
 SPHYGMOMANOMETER NOVA .....6, 7  
 SPHYGMOMANOMETER PRECISA .....9  
 SPINAL BONE CURETTES .....253  
 SPINAL HOOK TAYLOR .....291  
 SPINA-NASALIS RETRACTOR .....461  
 SPLINTERFORCEPS ARCHER .....92  
 SPLINTERFORCEPS PEET .....92  
 SPLINTERFORCEPS VIRTUS (PALK) .....92  
 SPLINTERFORCEPSSTIEGLITZ .....92  
 SPLINTERTISSUE FORCEPS .....91  
 SPLINTERTISSUE FORCEPS CARMALT .....91  
 SPLINTERTISSUE FORCEPS FEILCHENFELD .....91  
 SPLINTERTISSUE FORCEPS HUNTER .....91  
 SPOON MEDICINE .....621  
 SPRATT BONE CURETTES .....251  
 SPREADER DAVIS-BOYLE .....455  
 SPREADER DAVIS-MEYER .....457  
 SPREADER DINGMANN .....456  
 SPREADER KILNER-DOUGHTY .....456  
 SPURLING LAMINECTOMY RETRACTOR FORCEPS .....340  
 SPUTUM CUP .....621  
 SREWHOLDINGFORCEPS LANE .....325  
 ST. CLAIR-THOMSON AENOID CURETTE .....450  
 ST.MARKS PELVIS-HOOK .....165  
 ST.MARTIN TISSUE FORCEPS .....392  
 STACKE EARPROBES .....199  
 STAMMBERGER FORCEPS .....431  
 STAND .....188  
 STANDARD SURGICAL SCISSORS .....51  
 STAUDE-MOORE HOOK FORCEPS .....582  
 STEINMANN ENDER NAIL .....307, 308  
 STEINMANN TENDON HOLDINGFORCEPS .....292  
 STELLBRINK BONE RONGEUR .....234  
 STERILE SCALPEL .....43  
 STERILE SCALPEL-BLADE .....42  
 STERILE SPARE BLADE .....50  
 STERILIZATION CLAMP BUNT .....227  
 STERILIZATION CLAMP MAYO .....227  
 STERILIZATION FORCEPS .....227  
 STERILIZATION FORCEPS .....227  
 STERILIZATION FORCEPS CHEATLE .....227  
 STERILIZATION FORCEPS REDA .....615  
 STERILIZATION FORCEPS ROGGE .....227  
 STERILIZATION FORCEPS UNIVERSAL .....227  
 STERILIZATION TRAY .....622, 623  
 STERILIZATION TRAY .....616, 618  
 STERNBERG CHEEK RETRACTOR .....453  
 STERNUM SCISSORS SCHUMACHER .....481  
 STERNUMCHISELS LEBSCHER .....267  
 STETHOSCOPE ANESTOPHON .....23  
 STETHOSCOPE DUPLEX .....23  
 STETHOSCOPE PINARD .....23  
 STEVENS IRIS TISSUE FORCEPS .....383  
 STEVENS LINSENHOK .....375  
 STEVENS NEEDLE HOLDER .....214  
 STEVENS OPHTHALMOLOGIC SCISSORS .....58  
 STEVENS SUPERCUT SCISSORS .....72  
 STEVENSON EYE SPECULA .....371  
 STIEGLITZ SPLINTERFORCEPS .....92  
 STILLE ANATOMIC TISSUE FORCEPS .....81  
 STILLE BONE HAND DRILLS .....298  
 STILLE CHISELS .....260  
 STILLE CHISELS .....260  
 STILLE GOUGES .....260  
 STILLE HEMOSTATIC CLAMP .....122  
 STILLE PLASTERSCISSORS .....229

STILLE RIB SCISSORS .....480  
 STILLE SURGICAL TISSUE FORCEPS .....81  
 STILLE-BARRAYA VASCULARTISSUE FORCEPS .....88  
 STILLE-HORSLEY BONE CUTTING FORCEPS .....242  
 STILLE-LISTON BONE CUTTING FORCEPS .....241  
 STILLE-LUER BONE RONGEUR .....239  
 STILLE-RUSKIN BONE RONGEUR .....239  
 STILLE-SHERMAN BONE HAND DRILLS .....298  
 STOCKMANN PENISCLAMP .....553/1  
 STOMACH CLAMP LANE .....547  
 STOMACH-/BOWEL SUTUREING APPARTUS V.PETZ .....549  
 STOMACH-BOWEL CLAMP MIKULICZ .....543  
 STONE FORCEPS .....545  
 STONE HOLDING CLAMP .....545  
 STRABISMUS FORCEPS BONACCOLTO .....385  
 STRABISMUS FORCEPS DASTOOR .....386  
 STRABISMUS FORCEPS JAMESON .....385  
 STRABISMUS FORCEPS MCCULLOUGH .....385  
 STRABISMUS HOOK GRAEFE .....375  
 STRABISMUS HOOK JAMESON .....375  
 STRANDELL-STILLE RETRACTOR .....157  
 STRASSBURGER TISSUE FORCEPS .....89  
 STRATTE NEEDLE HOLDER .....212  
 STRAUSS PENISCLAMP .....553/1  
 STRIPPER .....202  
 STRULLY NEUROSURGICAL .....65  
 STRUYCKEN NOSE FORCEPS .....427  
 SUBRAMANIAN-MINIATURE .....521  
 SUCTION -IRRIGATION CANNULA .....394  
 SUCTION HANDLE WULLSTEIN .....338  
 SUCTION RASPATORIES GUILLEN .....433/1  
 SUCTION TUBE ADSON .....337  
 SUCTION TUBE ANDREW-PYNCHON .....28  
 SUCTION TUBE BABY-YANKAUER .....27  
 SUCTION TUBE BARON .....336  
 SUCTION TUBE COOLEY .....28  
 SUCTION TUBE DASTOOR .....380  
 SUCTION TUBE DEBAKEY .....28  
 SUCTION TUBE FRAZIER/FERGUSON .....337  
 SUCTION TUBE PLESTER .....338  
 SUCTION TUBE POOLE .....27  
 SUCTION TUBE ROSEN .....338  
 SUCTION TUBE TUBE KLEINSASSER .....36  
 SUCTION TUBE YANKAUER .....27  
 SUCTION TUBE YASARGIL .....337/1  
 SUCTION TUBE ZOELLNER .....337/1  
 SUCTION TUBE HOUSE .....337/2  
 SUPERCUT SCISSORS .....71  
 SUPERCUT SCISSORS BABY METZENBAUM .....71  
 SUPERCUT SCISSORS FREEMAN .....74  
 SUPERCUT SCISSORS GORNEY .....73  
 SUPERCUT SCISSORS IRIS .....72  
 SUPERCUT SCISSORS KAYE .....73  
 SUPERCUT SCISSORS KILNER/RAGNELL .....72  
 SUPERCUT SCISSORS LAGRANGE .....72  
 SUPERCUT SCISSORS LISTER .....72  
 SUPERCUT SCISSORS MAYO .....71  
 SUPERCUT SCISSORS MAYO-STILLE .....71  
 SUPERCUT SCISSORS METZENBAUM .....71  
 SUPERCUT SCISSORS REES .....73  
 SUPERCUT SCISSORS REYNOLDS .....72  
 SUPERCUT SCISSORS STEVENS .....72  
 SUPERCUT SCISSORS WAGNER .....72  
 SURGICAL NEEDLE .....222, 223  
 SURGICAL NEEDLE KEITH .....223  
 SURGICAL NEEDLE KOENIG .....223  
 SURGICAL SCISSORS FERGUSON .....66  
 SURGICAL SCISSORS FINE IRIS .....54  
 SURGICAL SCISSORS FINE JOSEPH .....54  
 SURGICAL SCISSORS FINE KILNER .....54  
 SURGICAL SCISSORS FINE REYNOLDS .....54  
 SURGICAL SCISSORS FINE SANVENERO .....54  
 SURGICAL SCISSORS METZENBAUM .....51, 54

SURGICAL SCISSORS STANDARD .....51  
 SURGICAL SCISSORS SYSTRUNK .....66  
 SURGICAL TISSUE FORCEPS .....81  
 SURGICAL TISSUE FORCEPS ADSON .....81/2  
 SURGICAL TISSUE FORCEPS ADSON MICRO .....81/2  
 SURGICAL TISSUE FORCEPS ADSON-BROWN .....82  
 SURGICAL TISSUE FORCEPS BONNEY .....88  
 SURGICAL TISSUE FORCEPS BROPHY .....84  
 SURGICAL TISSUE FORCEPS CUSHING .....83  
 SURGICAL TISSUE FORCEPS FERRIS-SMITH .....85  
 SURGICAL TISSUE FORCEPS GERALD .....87  
 SURGICAL TISSUE FORCEPS GILLIES .....86  
 SURGICAL TISSUE FORCEPS LANE .....84  
 SURGICAL TISSUE FORCEPS OEHLER TC .....81/1  
 SURGICAL TISSUE FORCEPS POTTS SMITH .....81  
 SURGICAL TISSUE FORCEPS SEMKEN .....86  
 SURGICAL TISSUE FORCEPS STILLE .....81  
 SURGICAL TISSUE FORCEPS TAYLOR .....87  
 SURGICAL TISSUE FORCEPS TYPE USA .....81/1  
 SURGICAL TISSUE FORCEPS WAUGH .....83  
 SUTUREFORC REDA .....221  
 SUTURESCISSORS HEATH .....66  
 SUTURESCISSORS LITTAUER .....66  
 SUTURESCISSORS NORTHBENT .....66  
 SUTURESCISSORS SPENCER .....66  
 SUTURING SET .....225  
 SWEET APPLIERSFORCEPS .....326  
 SYSTRUNK SURGICAL SCISSORS .....66

T  
 TABB KNIVES .....418  
 TABLET TRAY .....621  
 TAKAHASHI NOSE FORCEPS .....427  
 TANGENTIALCLAMP DEBAKEY-SATINSKY .....502  
 TARNIER CRANIPLAST .....607  
 TARNIER OBSTETRICAL FORCEPS .....604  
 TAYLOR PERCUSSION HAMMER .....24  
 TAYLOR SPINAL HOOK .....291  
 TAYLOR SURGICAL TISSUE FORCEPS .....87  
 TC SCISSORS FREEMAN .....74  
 TC SCISSORS PECK-JOSEPH .....74  
 TC SCISSORS REES .....73  
 TC SURGICAL SCISSORS FINE REYNOLDS TC .....54  
 TC SURGICAL SCISSORS STANDARD .....51  
 TC TISSUE FORCEPS CUSHING .....83  
 TC TISSUE FORCEPS GILLIES .....86  
 TC TISSUE FORCEPS SEMKEN .....86  
 TC TISSUE FORCEPS SURGICAL .....81  
 TC TISSUE FORCEPS WANGENSTEEN .....89  
 TC TISSUE FORCEPS ANATOMIC .....81  
 TC-SCISSORS GORNEY .....73  
 TC-SCISSORS KAYE .....73  
 TEALE HOOK FORCEPS .....583  
 TEBBETTS RETRACTOR .....197  
 TEETH TISSUE FORCEPS LONDON-COLLEGE .....93  
 TEETH TISSUE FORCEPS MERIAM .....93  
 TENDON GRASPING FORCEPS .....293  
 TENDON GRASPING FORCEPS JACKSON .....292  
 TENDON GRASPING FORCEPS LARSEN .....292  
 TENDON GRASPING INSTR KLEINERT-KUTZ .....294  
 TENDON GRASPING INSTRUMENT BRAND .....293  
 TENDON GRASPING INSTRUMENT CAROLL .....293  
 TENDON GUIDE BUNELL .....294  
 TENDON HOLDINGFORCEPSSTEINMANN .....292  
 TENDON PASSING INSTR. BRAND .....294  
 TENDON PASSING INSTR. BUNNELL .....292  
 TERSON CAPSULAR FORCEPS .....391  
 TESSIER RETRACTOR .....463/3  
 T-HANDLE .....300, 301  
 T-HANDLE HUDSON .....300  
 THOMAS UTERINE CURETTE .....599  
 THOMAS-GALLOR BIOPSY FORCEPS .....588  
 THOMS-ALLIS BOWEL GRASPING FORCEPS .....538



THOMSON-WALKER BLADDER RETRACTORS.....	552	TONSIL ELEVATOR HURD.....	465	TRAY UNIVERSAL.....	620
THORACIC SPREADER MERCEDES.....	489	TONSIL ELEVATOR LOPEZ-REINKE.....	465	TRELAT TONSIL NEEDLE.....	466
THOREK SCISSORS.....	65/2	TONSIL ELEVATOR YANKAUER.....	465	TRELAT VAGINAL SPECULA.....	571
THUDICHUM NOSE SPECULA.....	421	TONSIL FORCEPS BALLENGER.....	467	TROCAR COAKLEY.....	204
THYROID GLAND HOOK SCHOENBORN.....	479	TONSIL FORCEPS BLOHMKE.....	467	TROCAR DOUGLAS.....	205
TIECK-HALLE NOSE SPECULA.....	423	TONSIL FORCEPS MARSCHIK.....	468	TROCAR LICHTWITZ.....	204
TILLEY EAR FORCEPS.....	411	TONSIL FORCEPS NEGUS.....	467	TROCAR NELSON.....	205
TILT MECHANIC.....	194	TONSIL FORCEPS SAWTELL.....	467	TROCAR OCHSNER.....	205
TIP FOR SUCTION TUBE.....	27	TONSIL FORCEPS SCHNIDT.....	467	TROCAR PIERCE.....	204
TISCHLER-DOWN BIOPSY FORCEPS.....	591	TONSIL FORCEPS TYDING.....	467	TROCAR UNIVERSAL.....	204
TISCHLER-KEVORKIAN BIOPSY FORCEPS.....	592	TONSIL FORCEPS WHITE.....	467	TROCARSTANDARD (NELSON).....	204
TISCHLER-MORGAN BIOPSY FORCEPS.....	591	TONSIL GRASPING FORCEPS COLVER.....	467	TROELTSCH EAR FORCEPS.....	424
TISCHLER-MORGAN BIOPSY FORCEPS.....	590, 591	TONSIL NEEDLE.....	470	TROEMNER PERCUSSION HAMMER.....	24
TISCHLER-UP BIOPSY FORCEPS.....	591	TONSIL NEEDLE CLAU.....	466	TROUSSEAU TRACHEA DILATOR.....	476
TISSUE FORCEPS.....	90, 94	TONSIL NEEDLE DUPUY-WEISS.....	466	TROUSSEAU-BABY TRACHEA DILATOR.....	476
TISSUE FORCEPS ANATOMIC.....	81	TONSIL NEEDLE NAGER.....	466	TROUTMAN IRIS TISSUE FORCEPS.....	389
TISSUE FORCEPS BIPOLAR.....	630, 631	TONSIL NEEDLETRLAT.....	466	TROUTMAN IRIS TISSUE FORCEPS.....	384, 389
TISSUE FORCEPS BONNEY.....	88	TONSIL SCISSORS.....	59	TROUTMAN-CHRIS BLADEBREAKERS.....	45
TISSUE FORCEPS BROWN.....	83	TONSIL SCISSORS BOETTCHER.....	59	TUBAL CATHETER.....	596
TISSUE FORCEPS CASTROVIEJO.....	392	TONSIL SCISSORS DEAN.....	59	TUBBS AORTIC DILATOR.....	528
TISSUE FORCEPS DAVIS.....	227	TONSIL SCISSORS GOOD.....	59	TUBING ASSEMBLY.....	188
TISSUE FORCEPS DEBAKEY.....	99	TONSIL SCISSORS PRINCE.....	59	TUBING CLAMP HOFFMANN.....	624
TISSUE FORCEPS GERALD.....	86, 87	TONSIL SNARE BRUENINGS.....	468	TUBING CLAMP SIMPLEX.....	624
TISSUE FORCEPS GOMEL.....	96	TONSIL SNARE EVES.....	468	TUBINGCLAMP.....	129
TISSUE FORCEPS GRAEFE.....	83	TONSIL SYRINGE.....	470	TUBINGCLAMPBÜLOW-GUNAR-HEY.....	130
TISSUE FORCEPS JEWELRY.....	90	TONSIL WIRE.....	468	TÜBINGEN TISSUE FORCEPS.....	392
TISSUE FORCEPS MAYO.....	89	TONSIL-ELEVATOR HENKE.....	465	TUFFIER RETRACTOR.....	147
TISSUE FORCEPS MCPHERSON.....	392	TONSIL-KNIVES ABRAHAM.....	466	TUFFIER RIB SPREADER.....	487
TISSUE FORCEPS MOORFIELD.....	392	TONSIL-KNIVES BRUENINGS.....	466	TUFFIER TISSUE GRASPING FORCEPS.....	110
TISSUE FORCEPS PAUFIQUE.....	392	TONSIL-KNIVES CANFIELD.....	466	TUMOR GRASPING FORCEPS LANDOLT.....	341
TISSUE FORCEPS SINGLEY.....	88	TONSIL-KNIVES CARPENTER.....	465	TUMORTISSUE FORCEPS YASARGIL.....	97
TISSUE FORCEPS STRASSBURGER MODELL.....	89	TONSIL-KNIVES DOUGLAS.....	466	TUNING FORC.....	404
TISSUE FORCEPS TYPE TUEBINGEN.....	392	TONSIL-KNIVES FISHER.....	466	TUNING FORC HARTMANN.....	403
TISSUE FORCEPS ULTRA LIGHT.....	95	TONSILOTOME SLUDER-BALLENGER.....	470	TUNING FORC LUCAE.....	404
TISSUE FORCEPS WAGENSTEEN.....	89	TONSILOTOME TYDING.....	469	TUNING FORC REDA.....	403
TISSUE FORCEPS YASARGIL.....	97	TOOK CORNEAL SCARIFIER.....	373	TUNING FORCN RYDEL-SEIFFERT.....	404
TISSUE FORCEPS YASARGIL.....	392	TOURNIQUET RUMEL-BELMONT.....	528	TURNBULL NAIL FORCEPS.....	609
TISSUE GRASPING FORCEPS CHAPUT.....	110	TOWEL CLAMP.....	133	TURREL RECTAL BIOPSY FORCEPS.....	567
TISSUE GRASPING FORCEPS COLLIN.....	110	TOWEL CLAMP BACKHAUS.....	132	TYDING TONSIL FORCEPS.....	467
TISSUE GRASPING FORCEPS TUFFIER.....	110	TOWEL CLAMP BACKHAUS-CLIP.....	132	TYDING TONSILOTOME.....	469
TITANIUM CLIPS.....	549	TOWEL CLAMP BALL AND SOCKET.....	133	TYPE TÜBINGEN IRIS FORCEPS.....	387
TITANIUM HALSTED-MOSQUITO HEMOSTATIC CLAMP.....	105	TOWEL CLAMP BERNHARD.....	133	TYPE MÜNCHEN BIOPSY CURETTE.....	587
TITANIUM HEMOSTATIC CLAMP CRILE.....	107	TOWEL CLAMP DOYEN.....	133	TYPE VIENNA NOSE SPECULA.....	421
TITANIUM HEMOSTATIC CLAMP KELLY.....	106	TOWEL CLAMP JONES.....	132		
TITANIUM TISSUE FORCEPS DEBAKEY.....	99	TOWEL CLAMP JONES-CLIP.....	132	<b>U</b>	
TITANIUM-ATRAUMA-BULLDOG CLAMP.....	102	TOWEL CLAMP LANE.....	133	UCKERMANN COTTON-APPLICATOR.....	203
TOBOLD COTTON-APPLICATOR.....	203	TOWEL CLAMP LORNA.....	133	ULRICH BONE HOLDING FORCEPS.....	248
TOBOLD TONGUE DEPRESSORS.....	453	TOWEL CLAMP MOYNIHAN.....	133	ULRICH DRESSINGFORCEPS.....	135
TOENNIS DURA DISSECTOR.....	332	TOWEL CLAMP PEERS.....	132	ULTRA-LIGHT-TISSUE FORCEPS ATRAUMA.....	95
TOENNIS HEMOSTATIC CLAMP.....	117	TOWEL CLAMP ROEDER.....	132	UMBILICAL CORD SCISSORS BRAUN-STADLER.....	64
TOENNIS-ADSON DISSECTING SCISSORS.....	65	TOWEL CLAMP SCHAEDEL.....	132	UMBILICAL CORD SCISSORS BUSCH.....	64
TOHUKU TOWEL CLAMP.....	132	TOWEL CLAMP TOHOKU.....	132	UMBILICAL CORD SCISSORS SCHUMACHER.....	64
TONGUE BLADE DOUGHTY.....	458	TOWNLEY CALIPER.....	26	UMBILICAL CORD SCISSORS TYPE USA.....	64
TONGUE DEPRESSORS.....	451	TOWNSEND BIOPSY FORCEPS.....	591	UNI I DIAGNOSTIK-BES.....	13
TONGUE DEPRESSORS ANDREW.....	452	TOWNSEND MINI BIOPSY FORCEPS.....	591	UNI III DIAGNOSTIK-BES.....	15
TONGUE DEPRESSORS BRUENINGS.....	451	TOWNSEND TISCHLER MINI BIOPSY FORCEPS.....	591	UNIVERSAL BANDAGE SCISSORS.....	70
TONGUE DEPRESSORS BUCHWALD.....	451	TOYNBEE EAR SPECULA.....	399	UNIVERSAL ENDOSCOPE ASSEMBLY.....	188
TONGUE DEPRESSORS DAVIS-BOYLE.....	455	TRACHEA CANNULA LUER.....	479	UNIVERSAL STERILIZATION FORCEPS.....	227
TONGUE DEPRESSORS DINGMANN.....	456	TRACHEA CANNULA WAGENER-MOSHER.....	477	UNIVERSAL TRAY.....	620
TONGUE DEPRESSORS FRENZEL.....	451	TRACHEA CANNULACHEVALIER-JACK.....	479	UNIVERSAL TROCAR.....	204
TONGUE DEPRESSORS HARTMANN.....	452	TRACHEA DILATATOR. LABORDE.....	476	UNIVERSAL WIRESCISSORS.....	67
TONGUE DEPRESSORS KILNER-DOUGHTY.....	456	TRACHEA DILATOR. TROUSSEAU.....	476	UNIVERSALHANDLE HUBER.....	472
TONGUE DEPRESSORS KROENIG.....	451	TRACHEA DILATORTROUSSEAU-BABY.....	476	UNNA COMEDONE EXTRACTOR.....	608
TONGUE DEPRESSORS MAYO.....	451	TRACHEA HOOK BOSE.....	476, 477	URETHROTOME OTIS.....	553
TONGUE DEPRESSORS MORITZ-SCHMIDT.....	452	TRACHEA HOOK ITERSON.....	477	US ARMY RETRACTOR.....	141
TONGUE DEPRESSORS RING.....	455	TRACHEA HOOK JACKSON.....	476	USA ANATOMIC TISSUE FORCEPS.....	81
TONGUE DEPRESSORS RUSSEL-DAVIS.....	458	TRACHEA HOOK NEWS.....	477	USA TYPE UMBILICAL CORD SCISSORS.....	64
TONGUE DEPRESSORS TOBOLD.....	453	TRACHEOTOMY-SET.....	478	UTERINE CURETTE SIMON.....	594
TONGUE DEPRESSORS WIEDER.....	452	TRACHOMA FORCEPS KNAPP-LUER.....	393	UTERINE CURETTE BLAKE.....	595
TONGUE FORCEPS COLLIN.....	453	TRANSFORMATOR.....	22	UTERINE CURETTE BUMM.....	597
TONGUE FORCEPS YOUNG.....	453	TRANSFORMER FOR LARYNGOSCOPE HANDLE.....	34	UTERINE CURETTE GOURDET STUMPF.....	599
TONOMETER SCHIOETZ.....	394/2	TRAVERS RETRACTORS.....	172	UTERINE CURETTE RECAMIER.....	597
TONSIL FORCEPS ABRAHAM.....	468	TRAY.....	619	UTERINE CURETTE SCHRÖDER.....	595



UTERINE CURETTE SIMS .....597  
 UTERINE CURETTE THOMAS .....599  
 UTERINE DILATATOR GOODELL .....581  
 UTERINE DILATATOR HANK .....580  
 UTERINE DILATATOR HEGAR.....578, 579  
 UTERINE DILATATOR PRATT .....580  
 UTERINE DILATATOR SIMS .....581  
 UTERINE DILATATOR WYLIE .....581  
 UTERINE POLYP FORCEPS DOYEN .....585  
 UTERINE POLYP FORCEPS KELLY .....585  
 UTERINE POLYP FORCEPS NOTO .....585  
 UTERINE-DEPRESSOR BRAUN .....586  
 UTERINE-DEPRESSOR SIMS .....586  
 UTERINE-GRASPING FORCEPS COLLIN .....585  
 UTERINE-GRASPING FORCEPS DARTIGUES.....585  
 UTERINE-GRASPING FORCEPS SOMER .....585  
 UTERINE-KL.FORCEPSGREEN-ARMYTAGE .....605  
 UTERINE-PROBES COLLIN .....586  
 UTERINE-PROBES MARTIN .....586  
 UTERINE-PROBES SIMS .....586

V

VAGINAL SPECULA .....569  
 VAGINAL SPECULA JACKSON .....573  
 VAGINAL SPECULA AUWARD .....576  
 VAGINAL SPECULA BREISKY .....577  
 VAGINAL SPECULA COLLIN .....570  
 VAGINAL SPECULA CUSCO .....570  
 VAGINAL SPECULA DOYEN .....574  
 VAGINAL SPECULA GRAVE .....570  
 VAGINAL SPECULA KRISTELLER .....572  
 VAGINAL SPECULA LANDAU .....577  
 VAGINAL SPECULA PEDERSON .....570  
 VAGINAL SPECULA SEMM .....571  
 VAGINAL SPECULA SIMS .....573  
 VAGINAL SPECULA TRELAT .....571  
 VAGINAL SPECULA VU-MORE .....569  
 VAGINAL SPECULASCHERBAK .....575  
 VALLEIX PROBES .....586  
 VAN BUREN BONE HOLDING FORCEPS .....249  
 VAN BUREN DILATION BOUGIE .....554  
 VAN DOREN BIOPSY FORCEPS .....588  
 VANNAS EYESCISSORS .....79  
 VARADY VARIX INSTRUMENT .....202  
 VARICOSE VEIN PROBES NABATOFF .....201  
 VARIX INSTRUMENT VARADY .....202  
 VASCULAR CLAMP BAINBRIDGE .....495  
 VASCULAR CLAMP COOLEY .....518, 522  
 VASCULAR CLAMP DE BAKEY .....495  
 VASCULAR CLAMP DEBAKEY .....507, 514, 515  
 VASCULAR CLAMP DEBAKEY CHILDREN .....516  
 VASCULAR CLAMP GLOVER .....515  
 VASCULAR CLIP BIEMER.....361  
 VASCULAR CLIP MEHDORN .....362  
 VASCULAR CLIP MUELLER .....365  
 VASCULAR SCISSORS DE BAKEY .....61  
 VASCULAR SCISSORS DEBAKEY TC .....60  
 VASCULAR SCISSORS DIETRICH .....60  
 VASCULAR SCISSORS FAVALORO .....61  
 VASCULAR SCISSORS KELLY .....61  
 VASCULAR SCISSORS POTTS-SMITH .....61  
 VASCULAR-CANNULA SCHMID .....338  
 VASCULAR-DILATOR DEBAKEY .....529  
 VASCULARDISSECTOR ROBB .....530  
 VASCULARSCISSORS KLINKENBERG-LOTH.....65/2  
 VASCULARSCISSORS POTTS-DE MARTEL .....59  
 VASCULARSCISSORS SATINSKY .....65/1  
 VASCULARSCLAMP DIEFFENBACH.....104  
 VASCULARSCLAMP SATINSKY .....491  
 VASCULARTISSUE FORCEPS ADLERKREUTZ .....84  
 VASCULARTISSUE FORCEPS NELSON .....89  
 VASCULARTISSUE FORCEPSSITTLE-BARRAYA.....88  
 VASEKTOMIECLAMP .....553/2

VERBRUGGE BONE HOLDING FORCEPS .....245  
 VERBRUGGE-MÜLLER BONE LEVERS .....287  
 VERESS INSUFFLATION CANNULA .....206  
 VIENNA GUIDEPROBES .....221  
 VIRCHOW POST MORTEM KNIVES .....48  
 VIRTUS(RALK) SPLINTER .....92  
 VOLKMANN BONE CURETTES .....251  
 VOLKMANN CURETTE .....257  
 VOLKMANN RETRACTOR .....153  
 VOLKMANN RETRACTOR.....153, 156  
 VOLTOLINI NOSE SPECULA .....421  
 VU-MORE VAGINAL SPECULA .....569

W

WACHENFELDT CLIP TISSUE FORCEPS .....224  
 WADSWORTH-TODD CAUTER .....378  
 WAGENER-MOSHER TRACHEA CANNULA .....477  
 WAGNER HOOK .....409  
 WAGNER LAMINECTOMY RETRACTOR FORCEPS.....343  
 WAGNER SCISSORS .....67  
 WAGNER SUPERCUT SCISSORS.....72  
 WALDMANN EPISOTOMY SCISSORS .....64  
 WALLICH OVUM CURETTE .....607  
 WALSHAM SEPTUM STRAIGHTENING FORCEPS .....449  
 WALTON FOREIGN-BODY GOUGES .....374  
 WALTON COMEDONE EXTRACTOR .....608  
 WALTON FINGER RING SAW .....297  
 WANGENSTEIN VASCULARTISSUE FORCEPS.....89  
 WARTENBERG PINWHEEL .....25  
 WASTEFORCEPS SAUERBRUCH .....227  
 WATER JET PISTOL .....626  
 WATSON DERMATOM .....50  
 WATSON DERMATOM .....50  
 WATSON-CHEYNE .....283  
 WATSON-CHEYNE PROBES .....199  
 WATSON-WILLIAMS NOSE FORCEPS .....428  
 WAUGH SURGICAL TISSUE FORCEPS.....83  
 WEBER BLOOD VESSEL CLAMP .....501  
 WEBER CATARACT LOOP .....378  
 WEBSTER NEEDLE HOLDER .....208  
 WECKER EYESCISSORS .....75  
 WECKER IRIS SPATULA .....378  
 WEEK EYE SPECULA .....370  
 WEIL-BLAKESLEY NOSE FORCEPS .....426  
 WEITLANER RETRACTORS .....169  
 WEITLANER-WULLSTEIN RETRACTORS .....169  
 WELLER DISSECTING SCISSORS .....53/2  
 WELLS ENUCULATION CURETTE .....378  
 WERTHEIM GYNECOLOGICAL SCISSORS .....63  
 WERTHEIM HYSTERECTOMY CLAMP .....124, 128  
 WERTHEIM HYSTERECTOMY SCISSORS .....63  
 WERTHEIM-CULLEN HYSTERECTOMY CLAMP.....125  
 WEST NOSE CHISELS .....442  
 WESTCOTT EYESCISSORS .....75  
 WESTMACOTT NOSE DRESSING FORCEPS.....424  
 WESTON RECTALSNARE .....566  
 WHEELER CYCLODIALYSIS SPATULA .....379  
 WHEELER DISCISION KNIVES .....373  
 WHITE TONSIL FORCEPS .....467  
 WIBERG RASPIORIESIUM .....277  
 WIEDER TONGUE DEPRESSORS .....452  
 WIENER ANTRUM RASP .....443  
 WIENER IRIS HOOK .....375  
 WIGMORE PLASTER KNIVES .....229  
 WIKSTROEM HEMOSTATIC CLAMP .....117  
 WILDE POLYP SNARE .....411  
 WILDE POLYP SNARE .....433/2  
 WILDE(TROELTSCH) EAR FORCEPS .....410  
 WILDER PROBE .....381  
 WILDER CATARACT LOOP .....378  
 WILLET MARTEL GRASPING FORCEPS.....110  
 WILLIAMS BOWEL GRASPING FORCEPS .....539  
 WILLIAMS EYE SPECULA .....370

WILLIAMS SCREW DRIVER .....323  
 WILLIGER CURETTE .....255, 257  
 WILLIGER HAMMER .....271  
 WILLIGER RASPIORIES .....276  
 WINTER OVUM FORCEPS .....606  
 WIRE BASKET FOR ENDOSCOPE .....623  
 WIRE FORCEPS .....317, 318  
 WIRE FORCEPS BERRY TC .....319  
 WIRE FORCEPS CORWIN-HEGAR TC .....319  
 WIRE FORCEPS MAYO-HABERISSER TC .....319  
 WIRE GAUZE .....311  
 WIRE GRASPING FORCEPS .....318  
 WIRE GUIDE NEEDLE DEMEL .....315  
 WIRE INSTRUMENT DEMEL .....315  
 WIRE INSTRUMENT LOUTE .....315  
 WIRESAW OLIVECRONA .....332  
 WIRESCISSORS UNIVERSAL .....67  
 WITNER BIOPSY FORCEPS .....589  
 WOLFF PLASTER FORCEPS .....233  
 WOODSON DURA DISSECTOR .....333  
 WORST PROBES .....333  
 WOUND CURETTE ARRUGA.....378  
 WRIGLEY OBSTETRICAL FORCEPS .....602  
 WULLSTEIN KNIVES .....418  
 WULLSTEIN MICRO-CURETTE FORCEPS .....416  
 WULLSTEIN RETRACTORS .....171  
 WULLSTEIN SUCTION HANDLE .....338  
 WYLIE UTERINE DILATOR .....581

Y

YANCOSKIE RETRACTOR .....198  
 YANKAUER SUCTION TUBE .....27  
 YANKAUER TONSIL DISSECTOR .....465  
 YASARGIL ANEURYSM .....349, 350, 351, 352, 353, 354, 355, 356  
 YASARGIL GALEAHOOK .....330  
 YASARGIL SUCTION TUBE .....337/1  
 YASARGIL TUMORTISSUE FORCEPS .....97  
 YEOMAN RECTAL BIOPSY FORCEPS .....566, 567  
 YOUNG BOOMERANG .....220  
 YOUNG PROSTATIC HOOK .....550  
 YOUNG TONGUE FORCEPS .....453

Z

ZAUFAL EAR LEVER .....409  
 ZAUFAL-JANSEN BONE RONGEUR .....238  
 ZAUFAL-JANSEN EAR LEVER .....409  
 ZENKER HEMOSTATIC CLAMP .....118  
 ZENKER RETRACTOR .....161  
 ZIEGLER DISCISION KNIVES .....373  
 ZIEGLER EYE SPECULA .....371  
 ZIEGLER HEAD MIRRORS .....21  
 ZIEGLER IRIS KNIVES .....372  
 ZIEGLER LACHRYMAL DILATOR .....381  
 ZIELKE GOUGES .....264  
 ZOELLNER SUCTION TUBE .....337/1





Abraham bisturi para amigdalas.....	466	alicate corta-uñas Anvil.....	613	Backhaus-Clip pinza de campo.....	132
Abraham pinza para coger amigdalas.....	468	alicate cuticular.....	613	Bailey aproximador para costillas.....	489
abre-boca Davis-Boyle.....	455	alicate Grip.....	316	Bailey-Baby aproximador para costillas.....	489
abre-boca Davis-Meyer.....	457	alicate para cortar uñas Turnbull.....	609	Bailey-Gibbon aproximador para costillas.....	489
abre-boca Denhart.....	454	alicates.....	316-318, 320	Bainbridge pinza hemostatica.....	119/2
abre-boca Dingmann.....	456	alicates para cortar alambres.....	316-318, 320	Bainbridge pinza vascular de uso multiple.....	495
abre-boca Doyen-Jansen (Molt).....	454	Allen pinza para apendice.....	544	baja-lengua Andrew.....	452
abre-boca Heister.....	454	Allis pinza intestinal.....	537	baja-lengua Bruenings.....	451
abre-boca Jennings.....	454	Allis-Adair pinza intestinal.....	537	baja-lengua Buchwald.....	451
abre-boca Kilner-Doughty.....	456	Allis-Baby pinza intestinal.....	537	baja-lengua Cawood-Minnesota.....	451
abre-boca Mclvor.....	457	Allsion espátula pulmonar.....	489	baja-lengua Doughty.....	458
abre-boca Roser-Koenig.....	454	Alm separador.....	168	baja-lengua Frenzel.....	451
aceite para instrumentos Instru Care.....	634	Alvis cureta para cuerpos extraños.....	374	baja-lengua Hartmann.....	452
adaptador para iluminacion para amioscopio.....	600	amigdalotomo Sluder-Ballenger.....	470	baja-lengua Kroenig.....	451
adenotomo LaForce.....	450	amigdalotomo Tyding.....	469	baja-lengua Mayo.....	451
Adlerkreutz pinza de diseccion.....	84	amiotomo.....	586, 600	baja-lengua Moritz-Schmidt.....	452
Adson Baby pinza hemostatica.....	113	amiotomo Beacham.....	586	baja-lengua Ring.....	455
Adson elevador.....	282	Anderson Adson separador.....	172	baja-lengua Russel-Davis.....	458
Adson gancho para dura-madre.....	329	Anderson separador.....	198	baja-lengua Tobold.....	453
Adson pinza de diseccion.....	81/2, 82	Andrew baja-lengua.....	452	baja-lengua Wieder.....	452
Adson pinza de proteccion.....	298	ANDREW-PYNCHON tubo de aspiracion.....	28	baja-lenguas.....	451, 452, 453, 455
Adson pinza guia.....	236	ANESTOPHON estetoscopio.....	23	Bakes dilatador para conductos biliares.....	532
Adson pinza hemostatica.....	112, 113	anillo para KLEINSASSER.....	36	Balfour Baby separador abdominal.....	182, 183
Adson pinza para hipofisis.....	334	anoscopio Chelsea-Eaton.....	563	Balfour separador abdominal.....	182, 183
Adson porta aguja.....	211	anoscopio Hirschmann.....	562	Balfour-Us separador abdominal.....	184
Adson separador.....	172, 173, 174	anoscopio Ives-Fansler.....	562	Ball and Socket pinza para campo.....	133
Adson tubo de aspiracion.....	337	anteojos para nistagmo FRENZEL.....	20	Ballenger cuchillo para tabique nasal.....	436
Adson-Brown pinza de diseccion.....	82	Antrum cureta.....	435	Ballenger elevador para el tabique nasal.....	439
Adson-DeBakey pinza de diseccion.....	81/2	Anvil alicate corta-uñas.....	613	Ballenger pinza para coger amigdalas.....	467
AEBLI tijera corneal.....	58	aparato para suturar estomago y.....		bandejas.....	620
agrafe MICHEL.....	224	intestinos V. Petz.....	549	Bane-Hartmann pinza guia.....	237
aguja Barbara.....	419	aproximador de Biemer.....	366	Bangerter espátula para ciclodialisis.....	379
aguja de discision Bowman.....	374	aproximador de Biemer-Müller.....	363	Baracani punta de pinza.....	472
aguja de guia para anestesia.....	206	aproximador de Müller.....	364	Barany esordecedor.....	405
aguja de guia REDON.....	207	aproximador para costillas Bailey.....	489	Barbara aguja.....	419
aguja para amigdalas.....	470	aproximador para costillas Bailey-Baby.....	489	Barbara gancho.....	419
aguja para autopsia.....	268	aproximador para costillas Bailey-Gibbon.....	489	Barkan cuchillo para goniotomia.....	373
aguja para biopsia Franklin-Silvermann.....	206	Archer pinza para espinas.....	92	Barnhill cuchillo para vegetaciones adenoides.....	450
aguja para biopsia Menghini.....	206	Arit asa.....	378	Baron canula de succion.....	336
aguja para catarata.....	374	Arruga blefarostato.....	370	Barr especulo rectal.....	559
aguja para cuerpos extraños.....	374	Arruga gancho para extraccion.....	375	barra de traccion Gerster.....	250
aguja para cuerpos extraños Davis.....	374	Arruga pinza capsular.....	391	Barraquer (Colibri) blefarostato.....	370
aguja para cuerpos extraños Francis.....	374	Arruga porta aguja.....	214	Barraquer (Colibri) pinza para iris.....	384
aguja para cuerpos extraños Levinson.....	374	Arruga protector.....	378	Barraquer Colibri tijera para oftalmologia.....	75
aguja para laringe.....	470	articulacion para KLEINSASSER.....	36	Barraquer cuchillo para queratoplastica.....	373
aguja para ligadura.....	218, 219	asa Arit.....	378	Barraquer micro porta aguja.....	216, 217
aguja para ligadura Cooper.....	219	asa Billeau.....	409	Barraquer pinza depilatoria.....	395
aguja para ligadura Deschamps.....	218	asa Langenbeck.....	409	Barraquer pinza para fijacion.....	390
aguja para ligadura Kronecker.....	219	asa Shapleigh.....	410	Barraquer-Katzin pinza para iris.....	384
aguja para ligadura Nelson.....	219	asa Snellen.....	378	Barraquer-Troutmann micro porta aguja.....	216
aguja para ligadura Schmieden-Dick.....	219	asa Weber.....	378	Barrett pinza uterina.....	582
aguja para neumoperitoneo Verres.....	206	asa Wilder.....	378	Barton forceps obstetrico.....	603
aguja para paracentesis Lucae.....	408	Asch pinza para enderezar el tabique nasal.....	449	Barton tractor.....	603
aguja para paracentesis Politzer.....	408	Aufranc-Cobra separador.....	289	Baumgartner porta aguja.....	208
aguja para sutura amigdalas Dupuy-Weiss.....	466	Aufricht lima nasal.....	443	Beacham amiotomo.....	586
aguja para sutura del paladar Claus.....	466	Aufricht retractor nasal.....	447	Bechert rotador.....	379
aguja para sutura del paladar Claus-Eicken.....	466	Auward especulo vaginal.....	576	Beck pinza para anastomosis.....	516, 520
aguja para sutura del paladar Nager.....	466	Axenfeld cucharilla para chalazion.....	377	Becker quistotomo.....	375
aguja pasa-hilo Demel.....	315	Ayer pinza para ligadura.....	393	Beckmann cuchillo para vegetaciones adenoides.....	450
aguja Reverdin.....	220			Beckmann separador.....	176
aguja Yound Boomerang.....	220			BECKMANN-ADSON separador.....	175
agujas de sutura.....	222, 223			Beckmann-Eaton separador.....	176
Air Injection canula.....	394	B		Beebee tijera para coronas.....	68
alambre de Kirschner.....	306, 307	Babcock pinza intestinal.....	539	Beer pinza depilatoria.....	395
alambre de Steinmann.....	307, 308	BABINSKI martillo de percusion.....	24	Beeson separador para yesos.....	232
alambres.....	306, 307, 308, 309	Baby Burke pinza para biopsia.....	590	Bellucci tijera auricula micro.....	413, 417
Alan-Parks especulo rectal.....	561	Baby Gosset separador abdominal.....	181	Bengolea pinza hemostatica.....	112
Alderdyce elevador.....	282	Baby Metzenbaum tijera supercut.....	71	Bennett elevador.....	283
Alexander cincel.....	259	Baby-Kocher pinza intestinal.....	540	Bensaude protoscopio.....	565
Alexander guia.....	259	Baby-Olsen-Hegar porta aguja.....	212	Benson separador para piloro.....	544
Alexander periostotomo.....	276	BABYPHON esfigmomanometro.....	10	Berens cuchillo de discision.....	372
Alexander pinza para biopsia.....	589	Baby-Tischler pinza para biopsia.....	592	Bergmann martillo.....	272
alicate corta-uñas.....	609, 612/2, 613, 614	BABY-YANKAUER tubo de aspiracion.....	27	Bergmann tijera para vendaje.....	69/1
		Back holder separador abdominal.....	192, 193, 194, 195		
		Backhaus pinza de campo.....	132		



Berke pinza muscular.....	389	Bozemann-Douglas pinza porta esponja.....	138	canula irrigacion Eicken (Kilian).....	433
BERLINER martillo de percusion.....	24	Brand mondador de tendones.....	294	canula Kilian.....	433/1
Bernhard pinza de campo.....	133	Brand pinza de agarre para tendones.....	293	canula Lacrimal.....	394
Berry pinza para torcer hilo.....	319	Braun cranioclasto.....	607	canula lacrimal McIntyre.....	394
Bethune costotomo.....	481	Braun depresor uterino.....	586	canula para lavador vascular Schmid.....	338
Beyer pinza gubia.....	237, 238	Braun gancho de decapitacion.....	607	canula para traqueotomia Chevalier-Jackson.....	479
Biemer aproximador.....	366	Braun pinza uterina.....	582	canula para traqueotomia Luer.....	479
Biemer pinza para vasos.....	361	Braun-Stadler tijera para episiotomia.....	64	canula para traqueotomia Wagoner-Mosher.....	477
Biemer-Müller aproximador.....	363	brazalete para brazo.....	295	canula Sheets.....	394/2
Bier sierra para amputacion.....	296	brazalete para femur.....	295	canula Simcoe.....	394/2
Bill tractor.....	604	Breast separador mamaio.....	198	Carmalt pinza para espinas.....	91
Billeau asa.....	409	Breisky espejulo vaginal.....	577	Caroll pinza de agarre para tendones.....	293
Bircher-Ganske pinza para hueso.....	246	Bridge pinza hemostatica.....	116	Carpenter cuchillo para amigdalas.....	465
Birkett pinza hemostatica.....	116	Bristow elevador.....	290	Caspar hemostatico.....	258
Bishop-Harman pinza para iris.....	386	Brodie sonda acanalada.....	199	Caspar separador.....	179, 180
Bishop-Harmon canula de irrigacion y aspiracion.....	394/1	Brophy pinza de diseccion.....	84	Castaneda pinza vascular para neonatales.....	527
bisturi nasal Joseph.....	434, 435	Brown pinza de diseccion.....	83	Castroviejo blerarostato.....	371
bisturi para amigdalas Abraham.....	466	Brown porta aguja.....	209	Castroviejo compas marcador.....	380
bisturi para amigdalas Bruenings.....	466	Bruenings baja-lengua.....	451	Castroviejo cuchillo para discision.....	372
bisturi para amigdalas Canfield.....	466	Bruenings bisturi para amigdalas.....	466	Castroviejo dilatador lacrimal.....	381
bisturi para amigdalas Douglas.....	466	Bruenings cierranudos.....	468	Castroviejo espátula para ciclodialis... ..	379
bisturi para amigdalas Fisher.....	466	Bruenings espejulo auricular.....	401	Castroviejo pinza capsular.....	391
bisturi para fibroma Segond.....	594	Bruenings pinza nasal.....	425	Castroviejo pinza para fijacion.....	390
bisturías.....	46	Bruenings punta de pinza.....	472	Castroviejo pinza para sutura.....	392
Blake curetas uterinas.....	595	Bruenings tubo de extension.....	472	Castroviejo porta aguja.....	215
Blake pinza para calculos biliares.....	531	Brunetti cincel.....	268	CASTROVIEJO rompe hojas.....	45
blefarostato Arruga.....	370	Brünings-Lucas cincel.....	260	Castroviejo tijera para corneales.....	79
blefarostato Barraquer (Colibr).....	370	Brünings-Lucas gubia.....	260	Castroviejo tijera para iridectomia.....	79
blefarostato Bowman.....	370	Brunner costotomo.....	481	Castroviejo-Micro porta aguja.....	215
blefarostato Clark.....	370	Brunner pinza intestinal.....	543	Castroviejo-Standard micro porta aguja.....	216
blefarostato Critchett.....	370	Brunner separador.....	167	cateter auricular Hartmann.....	408
blefarostato Graefe.....	370	Brunner sonda conductora.....	221	cateter Coxeter.....	555
blefarostato Lancaster.....	371	Bruns cucharilla cortante.....	251, 254	cateter metalicos.....	555
blefarostato Lister-Burch.....	370	Bruns tijera para vendaje.....	70	CATLIN cuchillo para amputacion.....	44
blefarostato Mellinger.....	370	Bryant pinza para medicacion.....	137	cauterio Wadsworth-Todd.....	378
blefarostato Mellinger-Axenfeld.....	370	Buchwald baja-lengua.....	451	Cawood-Minnesota baja-lengua.....	451
blefarostato Murdock.....	370	Buck cureta.....	407	cepillo para uñas.....	611
blefarostato Smith.....	370	Buck elevador para cuerpos extraños.....	412	cesta de esterilizacion.....	621, 623
blefarostato Week.....	370	BUCK martillo de percusion.....	24	Chandler elevador.....	282
blefarostato Williams.....	370	Buck-Gramcko elevador.....	285	Chapat pinza hemostatica.....	110
blefarostato Ziegler.....	371	Buie canula de aspiracion rectal.....	566	Charnley separador abdominal.....	289
blerarostato Castroviejo.....	371	bujia dilatadora Dittel.....	554	Charriere sierra para amputacion.....	296
blerarostato Liebermann.....	371	bujia dilatadora Guyon.....	554	Cheatle pinza para esterilizacion.....	227
blerarostato Mueller.....	371	bujia dilatadora Van Buren.....	554	Chelsea-Eaton anoscopio.....	563
blerarostato Park.....	371	Bülow-Gunar-Hey pinza cierra-tubo.....	130	Cheron pinza porta esponja.....	137
blerarostato Stevenson.....	371	Bumm curetas uterinas.....	597	Cherry separador para laminectomia.....	488
Blohmke pinza para coger amigdalas.....	467	Bunell pasador de tendones.....	294	Chevalier-Jackson canula para traqueotomia.....	479
Blount elevador.....	288	Bunell perforador de mano.....	299	Chevalier-Jackson pinza para bronco-esofagoscopia.....	473
Blount separador para rodilla.....	289	Bunell separador para tendones.....	292	Childe pinza para aplicar agrafes.....	224
Blumenthal pinza gubia.....	236	Bunge cucharilla para exenteracion.....	378	cierra-nudo auricular Krause.....	411
Bodenhämmer espejulo rectal.....	559	Bunt clip para esterilizacion.....	227, 624	cierra-nudo auricular Wilde.....	411
Boerma forceps obstetrico.....	604	Bunt horquilla fijadora.....	373	cierra-nudo rectal Yeoman.....	566
BOETTCHEr tijera para amigdalas.....	59	Burke pinza para biopsia.....	590	cierranudos Bruenings.....	468
Böhler estribo para extension.....	312	Busch tijera para cordon umbilical.....	64	cierranudos Eves.....	468
Böhler pinza cortante para huesos.....	241	Bushe cucharilla cortante.....	256	cierra-tubos Hoffmann.....	624
Böhler pinza gubia.....	238			cierra-tubos Simplex.....	624
Boies elevador.....	277			cincel.....	259-261, 264, 265
bomba de aire.....	295	C		cincel Alexander.....	259
bombilla de repuesto para laringoscopio.....	29, 30	caja para esterilizacion.....	616, 618	cincel Brunetti.....	268
Bonaccolito pinza para estrabismo.....	385	cajas para instrumentos.....	617	cincel Brünings-Lucas.....	260
Bonn pinza para sutura.....	386	cailbrador decimal Iwanson.....	624	cincel de esternon Lebsche.....	267
Bonney pinza de diseccion.....	88	calibre.....	26	cincel Hibbs.....	265
Bose gancho para traqueotomia.....	477	calibre TOWNLEY.....	26	cincel nasal Cinelli.....	441
Bose separador traqueal.....	476	Canfield bisturi para amigdalas.....	466	cincel nasal Cottle.....	440
Boucheron espejulo auricular.....	399	canula Air Injection.....	394	cincel nasal Fomon.....	441
Bowman aguja de discision.....	374	canula capsular Jensen.....	394	cincel nasal Freer.....	442/1
Bowman blefarostato.....	374	canula de aspiracion rectal Buie.....	566	cincel nasal HajeK.....	442/1
Bowman cuchillo para discision.....	372	canula de aspiracion para mango de Zöllner y Wullstein.....	337/1	cincel nasal Kilian.....	442/1
Bowman sonda lacrimal.....	381	canula de inyeccion KLEINSASSER.....	36	cincel nasal Kilian-Claus.....	442/1
Boynton porta aguja.....	214	canula de irrigacion y aspiracion Bishop-Harmon.....	394/1	cincel nasal Neivert-Anderson.....	442
Boys-Allis pinza intestinal.....	538	canula de puncion Lichtwitz.....	433	cincel nasal Rubin.....	440
Bozemann pinza porta esponja.....	138	canula de succion Baron.....	336	cincel nasal Sheehan.....	441
Bozemann porta aguja.....	211	canula de succion KLEINSASSER.....	36	cincel nasal Silver.....	442
		canula Hartmann.....	433		



cincel nasal West.....	442/1	Cooley pinza para anastomosis.....	519, 520	cucharilla cortante Jacobson.....	257
cincel para cuerpos extraños Dix.....	374	Cooley pinza para cateter.....	510	cucharilla cortante Jansen.....	257
cincel para el tabique nasal Freer.....	439	Cooley pinza vascular.....	520	cucharilla cortante Lempert.....	256
cincel para extirpacion Rollet.....	374	Cooley pinza vascular de uso multiple.....	518-520	cucharilla cortante Martini.....	257
cincel Partsch.....	259	Cooley pinza vascular pediatrica.....	522	cucharilla cortante REDA.....	256
cincel rompe-craneo.....	267	Cooley separador.....	148	cucharilla cortante Schede.....	251
cincel Smith-Petersen.....	261	Cooley separador costal.....	485, 487	cucharilla cortante Scoville.....	253
cincel Stille.....	260	COOLEY tubo de aspiracion.....	28	cucharilla cortante Spinal.....	253
cincel tamponador para huesos Passow.....	260	Cooley-Derra pinza para anastomosis.....	519	cucharilla cortante Spratt.....	251
Cinelli cincel nasal.....	441	Cooper aguja para ligadura.....	219	cucharilla cortante Volkmann.....	251, 257
Circumflex micro tijera.....	76	copas graduadas.....	620	cucharilla cortante Williger.....	255, 257
Citelli pinza sacabocado.....	430	Cordes punta de pinza.....	472	cucharilla para aborto Cuzzi.....	606
cizalla para yesos Stille.....	229	Coronal Blow Lift separador.....	198	cucharilla para aborto Wallich.....	607
clamp atrauma Bulldog.....	100	Corwin-Hegar pinza para torcer hilo.....	319	cucharilla para cataratas Daviel.....	377
clamp atrauma Bulldog DeBaKey.....	100, 103	Coryllos (Thorax) separador.....	166	cucharilla para cataratas Graefe.....	377
clamp atrauma Bulldog Glover.....	100, 103	Coryllos costotomo.....	480	cucharilla para cataratas Knapp.....	378
clamp Bulldog de Titanio.....	102	Cos pinza auricular micro.....	414	cucharilla para chalazion Axenfeld.....	377
clamp Bulldog DeBaKey-Dietrich.....	101	costotomo.....	480, 481	cucharilla para chalazion Hebra.....	377
clamp Bulldog Dietrich.....	101	costotomo bethune.....	481	cucharilla para chalazion Meyhoefer.....	377
clamp umbilical Collin.....	605	costotomo Brunner.....	481	cucharilla para exenteracion Bunge.....	378
clamp umbilical Kane.....	605	costotomo Coryllos.....	480	cucharilla uterina Simon.....	594
CLAR lampara frontal.....	22	costotomo Giertz-Stille.....	481	cucharra para sangre.....	268, 621
Clark blefarostato.....	370	costotomo Gluck.....	480	cuchillo auricular Politzer.....	408
Claus aguja para sutura del paladar.....	466	costotomo Sauerbruch.....	481	cuchillo auricular Sexton.....	408
Claus-Eicken aguja para sutura del paladar.....	466	costotomo Sauerbruch-Frey.....	481	cuchillo corneal Eilschnig.....	373
Clayman gancho.....	376	costotomo Stille.....	480	cuchillo corneal Gill.....	373
Cleveland pinza gubia.....	235	Cottle (Maltz) lima nasal.....	444	cuchillo corneal Sato.....	373
clip para esterilizacion Bunt.....	227, 624	Cottle cincel nasal.....	440	cuchillo corneal Took.....	373
clip para esterilizacion Mayo.....	227, 624	Cottle cuchillo rinoplastico.....	435	cuchillo de discision Berens.....	372
clips para aneurisma Yasargil.....	345-356	Cottle elevador para el tabique nasal.....	439	cuchillo de discision Jaeger.....	372
clips para vasos de Müller.....	365	Cottle especulo nasal.....	423	cuchillo de hoz REDA.....	435
Cloward pinza cortante para laminectomia.....	342	Cottle gancho para la piel.....	448	cuchillo interoseo.....	44
Cloward separador.....	178	Cottle Joseph elevador para el tabique nasal.....	439	cuchillo para amigdales Carpenter.....	465
Cloward separador para cuerpo vertebral.....	339	Cottle martillo.....	273	cuchillo para amputacion CATLIN.....	44
Cloward separador para tejido cervical.....	339	Cottle pinza para columna.....	448	cuchillo para amputacion LANGENBECK.....	44
coagulacion bipolar.....	630-633	Cottle pinza para fijacion.....	410	cuchillo para amputacion LISTON.....	44
Coakley cureta para seno.....	449	Cottle retractor nasal.....	447, 447/1	cuchillo para amputacion REDA.....	44
Coakley trocar para seno maxilar.....	204	COTTLE tijera nasal.....	59	cuchillo para autopsia.....	48
COBB cureta.....	252	COTTLE tijera para cirugia.....	56	cuchillo para autopsia VIRCHOW.....	48
Cobb gubia.....	262	Cottle-Kazanjian pinza cortante para huesos.....	241	cuchillo para cataratas Deutschmann.....	371
Cobb periostotomo.....	280	Cottle-Neivert gancho para la piel.....	448	cuchillo para cataratas Graefe.....	371
Cocciough pinza sacabocado para discos intervertebral.....	344/1	Coxeter cateter.....	555	cuchillo para cerebro VIRCHOW.....	48
Colibri (Barraquer) blefarostato.....	370	Crafoord pinza hemostatica.....	118	cuchillo para discision Wheeler.....	373
Colibri Barraquer tijera para oftalmologia.....	75	Crafoord tijera pulmonares.....	65/2	cuchillo para discision Bowman.....	372
Colibri pinza para iris.....	384	Crafoord-Sellors pinza hemostatica.....	119	cuchillo para discision Castroviejo.....	372
Coller-Crile pinza hemostatica.....	106	cranioclasto Braun.....	607	cuchillo para discision Graefe.....	372
Collier pelvimetro.....	605	cranioclasto Tarnier.....	607	cuchillo para discision Ziegler.....	373
Collier porta aguja.....	208	Crego elevador.....	282	cuchillo para falanges.....	44
Collin clamp umbilical.....	605	Crile gancho para nervio.....	328	cuchillo para goniotomia Barkan.....	373
COLLIN dinamómetro.....	25	Crile pinza hemostatica.....	107	cuchillo para goniotomia Scheie.....	373
Collin especulo vaginal.....	570	Crile porta aguja.....	213	cuchillo para iris Dean.....	372
Collin histero metro.....	586	Crile separador.....	140	cuchillo para iris Knapp.....	372
Collin Loktite separador abdominal.....	191	Crile-Murray porta aguja.....	209	cuchillo para iris Ziegler.....	372
COLLIN mango de bisturi.....	40	Crile-Rankin pinza hemostatica.....	107	cuchillo para organos.....	48
Collin martillo.....	270	Crile-Wood porta aguja.....	209	cuchillo para peristio.....	47
Collin pelvimetro.....	605	Critchett blefarostato.....	370	cuchillo para queratoplastica Barraquer.....	373
Collin pinza hemostatica.....	110	Crutchfield perforador inicial.....	327	cuchillo para queratoplastica Paufigue.....	373
Collin pinza para el utero.....	585	Crutchfield pinza de traccion craneal.....	327	cuchillo para reseccion.....	47
Collin pinza para quitar agrafes.....	224	cupeta para placenta.....	621	cuchillo para reseccion LANGENBECK.....	47
Collin pinza para tejido.....	539	cupeta Petri.....	620	cuchillo para tabique nasal Ballenger.....	436
Collin pinza porta esponja.....	137	cupetas.....	619	cuchillo para tabique nasal Freer.....	434
Collin pinza tira-lengua.....	453	cuchara medicinal.....	268	cuchillo para vegetaciones adenoides Barnhill.....	450
Collin separador.....	139	cuchara para calculos biliares Desjardins.....	534	cuchillo para vegetaciones adenoides Beckmann.....	450
Collin separador abdominal.....	190	cuchara para calculos biliares Fergusson.....	533	cuchillo para vegetaciones adenoides St.Clair-Thomson.....	450
Collin-Duval pinza de diseccion.....	85	cuchara para calculos biliares Luer-Koerte.....	533	cuchillo para vendaje enyesado Esmarch.....	233
Collin-Hartmann separador.....	141	cuchara para calculos biliares Mayo.....	534	cuchillo para vendaje enyesado Hopkins.....	233
Colver pinza para coger amigdalas.....	467	cuchara para calculos biliares Moor.....	532	cuchillo para vendaje enyesado Reiner.....	233
compas marcador Castroviejo.....	380	cuchara y gancho Gross.....	409	cuchillo para vendajes enyesados Wigmore.....	229
Cone pinza sacabocado craneal.....	331	cucharilla cortante.....	251-257	cuchillo Plester.....	418
Connin-Amsler marcador.....	380	cucharilla cortante Bruns.....	251, 254	cuchillo rinoplastico Converse.....	435
Converse cuchillo rinoplastico.....	435	cucharilla cortante Bushe.....	256	cuchillo rinoplastico Cottle.....	435
Converse separador.....	448	cucharilla cortante Daubenspeck.....	255	cuchillo Rosen.....	418
Cooley dilatador de aorta.....	528	cucharilla cortante Halle.....	253	cuchillo Schukhnecht.....	418

cuchillo Tabb .....	418	DeBaKey pinza vascular de uso multiple .....	495, 507, 508, 514, 515	Dingman elevador .....	463/3
cuchillo Wullstein .....	418	DeBaKey pinza vascular pediátrica .....	516, 517	Dingman periotostomo .....	463
Culler espátula para iris.....	378	DeBaKey pinzas traumáticas .....	98, 99	Dingmann abre-boca.....	456
cureta Antrum .....	435	DeBaKey porta aguja.....	210	Dingmann pinza para hueso .....	246
cureta aspiradora .....	600	DeBaKey separador.....	189/1	DIPLOMAT esfigmomanómetro.....	5
cureta aspiradora para biopsia uterina Novak .....	587	DeBaKey tijera .....	60	disecador corneal Green .....	374
cureta aspiradora para biopsia uterina Randall .....	587	DeBaKey tijera vascular .....	61	disecador corneal Paton .....	373
cureta Buck .....	407	DeBaKey-Bahnon pinza para aneurisma.....	506	disecador para el saco lacrimal Lang .....	378
cureta Cobb .....	252	DeBaKey-Dietrich clamp Bulldog .....	101	disecador vascular Robb .....	530
cureta Faulkner.....	449	DeBaKey-Mosquito pinza hemostática .....	509	disecador Watson-Cheyne.....	199
cureta House .....	420	DeBaKey-Pean pinza hemostática traumática .....	513	disector Fisch .....	420
cureta para aborto Pestalozza .....	606	DeBaKey-Rankin pinza hemostática traumática .....	512	disector Gorney .....	277
cureta para biopsia Heany .....	587	DeBaKey-Satinsky pinza para oclusión tangencial .....	502	dispensador de cepillos .....	611
cureta para biopsia Kevorkian .....	587	DeBaKey-Semb pinza para ligadura y la aorta .....	499	dispensador para brocas filiformes.....	310
cureta para biopsia Mod. Muenchen .....	587	dedal .....	311	Dittel buja dilatadora .....	554
cureta para cuerpos extraños Alvis .....	374	DEJERINE martillo de percusión.....	24	Dix cincel para cuerpos extraños .....	374
cureta para hipofisis .....	334	Delee espejo vaginal .....	574	Dix instrumento para cuerpo extraños (doble).....	380
cureta para hipofisis RAY .....	334	DeMartel guía conductora.....	330	Doren pinza para biopsia .....	588
cureta para lupus Fox .....	608	Demel aguja pasa-hilo.....	315	Doughty baja-lengua.....	458
cureta para lupus Piffard .....	608	Demel tensor de cierra-hilo.....	315	Douglas bisturi para amígdalas.....	466
cureta para seno Coakley .....	449	Denhart abre-boca.....	454	Douglas pinza depilatoria .....	395
curetadas uterinas Blake .....	595	Denis-Browne separador abdominal .....	185	Douglas trocar .....	204
curetadas uterinas Bumm .....	597	depressor para epiglotis Reichert .....	471	Doyen espejo vaginal .....	574
curetadas uterinas Gourdet .....	599	depressor uterino Braun .....	586	Doyen estilete acanalado .....	199
curetadas uterinas Recamier.....	597	depressor uterino Sims .....	586	Doyen periotostomo .....	278
curetadas uterinas Schröder .....	595	DERF porta aguja .....	208	Doyen pinza de campo .....	133
curetadas uterinas Sims.....	597	dermatomo HUMBY .....	50	Doyen pinza intestinal .....	540
curetadas uterinas Thomas .....	599	dermatomo SCHINK.....	49	Doyen pinza para polipos uterinos .....	585
Cusco espejo vaginal .....	570	dermatomo SILVER .....	50	Doyen separador .....	163
Cushing espátula cerebral .....	336, 369	dermatomo WATSON .....	50	Doyen separador abdominal.....	189/1
Cushing gancho para nervio .....	328	Derra pinza para anastomosis .....	515	Doyen tijera ginecológica .....	63
Cushing pinza cortante para laminectomía .....	340	D'Errico separador para la raíz de nervios .....	329/2	Doyen tirabuzon para fibroma.....	594
Cushing pinza de disección .....	83	Deschamps aguja para ligadura .....	218	Doyen-Baby pinza intestinal .....	540
Cushing separador .....	151, 152, 153	Desjardins cuchara para calculos biliares.....	534	Doyen-Jansen (Molt) abre-boca.....	454
Cushing-Taylor pinza de disección .....	87	Desjardins explorador para calculos biliares .....	532	Doyen-Stille separador .....	167
Cuzzi cucharilla para aborto .....	606	Desjardins pinza hemostática .....	121	Dubois tijera ginecológica .....	63
Czerny espejo rectal .....	559	Desjardins pinza para calculos biliares .....	531	Duehrsen pinza de disección .....	84
Czerny pinza uterina .....	584	Desmarres pinza para chalazión .....	393	Duplay pinza porta-esponja .....	134
D		Desmarres separador .....	151	Duplay pinza uterina .....	582
Dandy gancho para nervio .....	328	desobitador de vena.....	202	DUPLEX estetoscopio .....	23
Dandy pinza hemostática .....	109	destornillador Lane .....	323, 324	Dupuy-Weiss aguja para sutura amígdalas .....	466
Darling separador .....	178	destornillador Williams .....	323	Durante pinza de disección .....	88
Dartigues pinza para el útero .....	585	Deutschmann cuchillo para cataratas.....	371	Duval pinza de disección .....	85
Dastoor pinza para estrabismo .....	386	Devilbiss pinza sacabocado craneal .....	332	Duval pinza para tejido.....	539
Daubenspeck cucharilla cortante.....	255	diapason Hartmann .....	403	E	
Davidson (Scapula) separador .....	166	diapason REDA .....	403	Echlin pinza gubia .....	240
Daviel cucharilla para cataratas .....	377	diapason Lucae .....	404	ECO "T" y "C" estuche de diagnóstico .....	16
Davis aguja para cuerpos extraños .....	374	diapason Rydel-Seiffert.....	404	Eicken (Killian) canula irrigación .....	433
Davis elevador para duramadre .....	332	diaposones .....	403, 404	electrocirugía .....	628, 629
Davis espátula cerebral .....	337	Dieffenbach serra-fina .....	104	elevador .....	281-289
Davis pinza para esterilización de jeringas .....	227	Dieter pinza auricular micro .....	414	elevador Adson .....	282
Davis-Boyle abre-boca.....	455	Dietrich clamp Bulldog .....	101	elevador Alderdyce.....	282
Davis-Meyer abre-boca.....	457	Dietrich pinza para la aorta .....	510	elevador auricular Zaufal .....	409
Day gancho auricular .....	409	DIETRICH tijera vascular .....	60	elevador auricular Zaufal-Jansen .....	409
De Boer separador costal .....	486	dilatador de aorta Cooley.....	528	elevador Bennett .....	283
De Lee forceps obstetrico .....	602	dilatador de aorta Tubbs .....	528	elevador Blount .....	288
De Martel-Wolfson pinza para anastomosis .....	546	dilatador lacrimal Castroviejo.....	381	elevador Boies.....	277
De Martel-Wolfson pinza para cerrar clips .....	546	dilatador lacrimal Wilder .....	381	elevador Bristow .....	290
De Martel-Wolfson porta-clamps .....	546	dilatador lacrimal Ziegler .....	381	elevador Buck-gramcko .....	285
Dean cuchillo para iris.....	372	dilatador para conductos biliares Bakes.....	532	elevador Chandler .....	282
DEAN tijera para amígdalas .....	59	dilatador para el seno Ritter-Halle .....	433	elevador Crego .....	282
DEAVER separador .....	145, 146	dilatador para el seno Siebenmann .....	433/1	elevador Dingman .....	463/3
DEAVER tijera de disección .....	52	dilatador traqueal Laborde .....	476	elevador Hohmann .....	284, 285
DEAVER-GRIP separador.....	146	dilatador traqueal Trousseau-Baby .....	476	elevador Hohmann mini .....	286
DeBaKey clamp trauma Bulldog .....	100, 103	dilatador uterino Goodell.....	581	elevador Key .....	282
DeBaKey dilatador vascular .....	529	dilatador uterino Hank .....	580	elevador König .....	284
DeBaKey pinza para anastomosis.....	505, 515	dilatador uterino Hegar .....	578, 579	elevador Lane .....	290
DeBaKey pinza para aneurisma de la aorta.....	496, 497, 498	dilatador uterino Pratt .....	580	elevador Lane Trethowan .....	290
DeBaKey pinza para ligadura .....	493	dilatador uterino Sims .....	581	elevador Lange-Hohmann.....	286
DeBaKey pinza para ligadura .....	499, 500	dilatador uterino Wylie .....	581	elevador Lempert .....	420
DeBaKey pinza para vasos periféricos.....	494	dilatador vascular DeBaKey .....	529	elevador Mc Donald .....	283
		dinamómetro COLLIN .....	25	elevador Murphy-Lane .....	283

elevador Obwegeser .....	461	espatula cerebral Heifetz .....	369	estilete acanalado Doyen .....	199
elevador para amígdalas Henke .....	465	espatula cerebral Olivecrona .....	336	estilete hoja mirte .....	199
elevador para amígdalas Hurd .....	465	espatula Locke .....	612/1	estribo para extension Böhler .....	312
elevador para amígdalas Lopez-Reinke .....	465	espatula para ciclodialisis Bangerter .....	379	estribo para extension Kirschner .....	312
elevador para amígdalas Yankauer .....	465	espatula para ciclodialisis Castroviejo .....	379	estribo para extension Kirschner U.S. ....	312
elevador para cuerpos extraños Buck .....	412	espatula para ciclodialisis Elschmig .....	379	estuche de bolsillo y sutura .....	225
elevador para cuerpos extraños Quire .....	412	espatula para ciclodialisis Hirschman .....	379	estuche de diagnostico ECO "T" y ECO "C" ..	16
elevador para duramadre .....	332, 333	espatula para ciclodialisis Wheeler .....	379	estuche de diagnostico UNI I .....	13
elevador para duramadre Davis .....	332	espatula para enucleacion Wells .....	378	estuche de diagnostico UNI II .....	14
elevador para duramadre Frazier .....	333	espatula para iris Culler .....	378	estuche de diagnostico UNI III .....	15
elevador para duramadre Hoen .....	333	espatula para iris Wecker .....	378	estuche para autopsia .....	269
elevador para duramadre Horsley .....	333	espatula para la intima Robb .....	530	estuche para sutura Standard .....	226
elevador para duramadre Milligan .....	332	espatula pulmonar Allison .....	489	estuche para sutura y agrafes .....	225
elevador para duramadre Olivecrona .....	332	espatula vesical Kocher .....	552	estuche para traqueotomia .....	478
elevador para duramadre Penfield .....	333	espatula vesical Legueu .....	552	estuches de diagnostico RI-MINI .....	17
elevador para duramadre Sachs .....	332	espatulas abdominales .....	143, 143/1	estuches para esterilizar agujas .....	615
elevador para duramadre Toennis .....	332	especula vaginal Vu-More .....	569	Eves cierranudos .....	468
elevador para duramadre Woodson .....	333	especulo auricular Boucheron .....	399	EXACTA-SPEZIAL esfigmomanómetro .....	8
elevador para el tabique nasal Ballenger .....	439	especulo auricular Bruenings .....	401	explorador para calculos biliares Desjardins ..	532
elevador para el tabique nasal Cottle .....	439	especulo auricular Gruber .....	399	explorador para calculos biliares Moynihan ..	532
elevador para el tabique nasal Cottle Joseph ..	439	especulo auricular Hartmann .....	399	extractor Küntschner .....	322
elevador para el tabique nasal Freer .....	437	especulo auricular Politzer .....	399	extractor/impactor para clavos .....	321, 322
elevador para el tabique nasal Hajek-Ballenger ..	439	especulo auricular Richnau-Holmgren .....	400	F	
elevador para el tabique nasal Halle .....	437	especulo auricular Siegle .....	402	face lift tijera Freeman .....	73
elevador para el tabique nasal Howarth .....	438	especulo auricular Toynbee .....	399	face lift tijera Gorney .....	73
elevador para el tabique nasal Joseph .....	437	especulo endocervical Kogan .....	577	face lift tijera kaye .....	73
elevador para el tabique nasal Killian .....	438, 439	especulo Friedmann .....	577	face lift tijera Peck Joseph .....	73
elevador para el tabique nasal McKenty .....	437, 438	especulo nasal Cottle .....	423	Face lift tijera Rees .....	73
elevador para el tabique nasal Pennington .....	438	especulo nasal Hartmann .....	422	Fansler protoscopio .....	564
elevador para el tabique nasal Pierce .....	438	especulo nasal Hartmann-Halle .....	421	Farabeuf periototomo .....	274
elevador para el tabique nasal Roger .....	437	especulo nasal Killian .....	423	Farabeuf pinza para hueso .....	243
elevador SAYRE .....	281	especulo nasal Mod. Vienna .....	421	Farabeuf separador .....	139
elevador Verbrugge-Müller .....	286/2	especulo nasal REDA .....	423	Farabeuf-Collin periototomo .....	274
elevador Watson-Cheyne .....	283	especulo nasal Thudichum .....	421	Farabeuf-Lambotte pinza para hueso .....	243
Elliot forceps obstetrico .....	602	especulo nasal Tieck-Halle .....	423	Farrell porta-algodon .....	203
Ellis gubia para cuerpos extraños .....	374	especulo nasal Voltolini .....	421	Faulkner cureta .....	449
Elschnig cuchillo corneal .....	373	especulo rectal Alan-Parks .....	561	Faure pinza para biopsia .....	588
Elschnig espatula para ciclodialisis .....	379	especulo rectal Barr .....	559	Faure pinza para peritoneo .....	123
Elschnig pinza capsular .....	391	especulo rectal Bodenhammer .....	559	Favaloro tijera vascular .....	61
Elschnig pinza para fijacion .....	389	especulo rectal Czerny .....	559	Fehland pinza intestinal .....	542
Emmet gancho para fistulas .....	594	especulo rectal Hill-Ferguson .....	560	Feilchenfeld pinza para espinas .....	91
Engel sierra para vendajes enyesados .....	229	especulo rectal Mathieu .....	560	Feldheim pinza para huesos .....	249
ensordecedor Barany .....	405	especulo rectal Pratt .....	559	Fergusson cuchara para calculos biliares .....	533
ENUCLEATION tijera .....	58	especulo rectal Sawyer .....	560	Fergusson pinza hemostatica .....	109
Epker osteotomo .....	464/2	especulo rectal Schulze-Bergmann .....	560	Fergusson pinza para hueso .....	243
Eppendorfer pinza para biopsia .....	590	especulo rectal Sims .....	559	Fergusson tijera para intestino .....	66
escariador .....	304	especulo vaginal .....	569-577	Fergusson tubo de aspiracion .....	337
escariador Perthes .....	304	especulo vaginal Auvard .....	576	Ferriera separador para cirugia plastica .....	197
esclerotomo Guyton-Lundsgaard .....	373	especulo vaginal Breisky .....	577	Ferris-Smith pinza cortante para laminectomia ..	343
esclerotomo Lundsgaard .....	373	especulo vaginal Collin .....	570	Ferris-Smith pinza de diseccion .....	85
escofina nasal Miller .....	444	especulo vaginal Cosco .....	570	Ferris-Smith-Kerrison pinza sacabocado para	
escofina nasal Miller .....	444	especulo vaginal Cosco .....	571	discos intervertebral .....	344, 344/2
escofina nasal Peet .....	446	especulo vaginal Delee .....	574	Finocchio pinza bronquial .....	490
escofina nasal Wiener .....	443	especulo vaginal Doyen .....	574	Finocchio porta aguja .....	211
escupidora .....	621	especulo vaginal Grave .....	570	Finocchio separador costal .....	482, 484
esfigmomanómetro BABYPHON .....	10	especulo vaginal Jackson .....	573	Finocchio-Burford separador costal .....	483
esfigmomanómetro EXACTA-SPEZIAL .....	8	especulo vaginal Kallmorgen .....	573	Finsen separador .....	168
esfigmomanómetro MINIMUS II .....	11	especulo vaginal Kristeller .....	572	Fisch disector .....	420
esfigmomanómetro MINIMUS III .....	12	especulo vaginal Landau .....	577	Fisch gancho para duramadre .....	335
esfigmomanómetro NOVA .....	7	especulo vaginal O'Sullivan-O'Connor .....	576	Fischer pinza para iris .....	384
esfigmomanómetro NOVA-PRESAMETER .....	6	especulo vaginal Pederson .....	570	Fish sonda .....	199
esfigmomanómetro PRECISA .....	9	especulo vaginal Scherbak .....	575	Fisher bisturi para amígdalas .....	466
esfigmomanómetro, DIPLOMAT .....	5	especulo vaginal Semm .....	571	Foerster pinza para iris .....	383
Esmarch cuchillo para vendaje enyesado .....	233	especulo vaginal Sims .....	573	Foerster porta esponjas .....	136
Esmarch tijera para vendaje .....	69/2	especulo vaginal Trelat .....	571	Fomon cincel nasal .....	441
Esmarch vendaje de compresion .....	296	espejo frontal ZIEGLER .....	21	Fomon gancho nasal .....	447/1
espatula .....	203	espejo laringeo .....	473	Fomon lima nasal .....	444, 445
espatula abdominal Haberer .....	143/1	espejo laringeo Michel .....	423	Fomon periototomo .....	277
espatula abdominal Kader .....	143/1	estetoscopio ANESTOPHON .....	23	FOMON tijera nasal .....	58
espatula abdominal Kümmel .....	144	estetoscopio DUPLEX .....	23	Fomon tijera para rinoplastia .....	65/1
espatula abdominal Ribbon .....	143	estetoscopio PINARD .....	23	forceps obstetrico Barton .....	603
espatula cerebral Cushing .....	336, 369	estilete abotonado .....	199	forceps obstetrico Boerma .....	604
espatula cerebral Davis .....	337	estilete acanalado abotonado .....	199		





forceps obstetrico De Lee.....	602	gancho para estrabismo Graefe.....	375	Graefe pinza para iris.....	382
forceps obstetrico Elliot.....	602	gancho para estrabismo Jameson.....	375	Graefequistotomo.....	375
forceps obstetrico Kielland.....	602	gancho para extraccion Arruga.....	375	GRAEFFE tijera para cirugia.....	56
forceps obstetrico Kielland-Luikart.....	603	gancho para fistulas Emmet.....	594	Graham gancho para nervio.....	329
forceps obstetrico Luikart.....	603	gancho para galea Yasargil.....	330	Graig pinza para tabique nasal.....	426
forceps obstetrico McLean.....	603	gancho para iris O'Conner.....	375	grapa para cuero cabelludo Raney.....	327
forceps obstetrico McLean-Tucker.....	603	gancho para iris Wiener.....	375	grapas.....	326
forceps obstetrico McLean-Tucker-Luikart.....	603	gancho para la piel Cottle.....	448	Grave especulo vaginal.....	570
forceps obstetrico Naegele.....	602	gancho para la piel Cottle-Neivert.....	448	Gray pinza hemostatica.....	121
forceps obstetrico Piper.....	604	gancho para la piel Freer.....	448	Green disecador corneal.....	374
forceps obstetrico Simpson.....	602	gancho para la piel Gillies.....	448	Green gancho muscular.....	375
forceps obstetrico Simpson-Braun.....	602	gancho para las alas de la nariz Lange.....	448	Green pinza para fijacion.....	390
forceps obstetrico Simpson-Luikart.....	603	gancho para nervio Crile.....	328	Green separador.....	160
forceps obstetrico Tarnier.....	604	gancho para nervio Cushing.....	328	Green-Armytage pinza para uterus.....	605
forceps obstetrico Wrigley.....	602	gancho para nervio Dandy.....	328	Gregory pinza atraumatica.....	517
FOREGGER juego de laringoscopia.....	31	gancho para nervio Graham.....	329	Greven pinza auricular micro.....	414
FOREGGER laringoscopia.....	29	gancho para nervio Sachs.....	329	Grip alicata.....	316
Fox cureta para lupus.....	608	gancho para nervio Smithwick.....	329	Gross cuchara y gancho.....	409
Fraenkel pinza para laringe.....	471	gancho para nervios Kraysenbühl.....	336	Gross-Maier pinza porta-esponja.....	134
Fraenkel punta de pinza.....	472	gancho para sacar el inserto I.U.D.....	593	Gruber especulo auricular.....	399
Francis aguja para cuerpos extraños.....	374	gancho para traqueotomia Bose.....	477	gubia.....	259-265
Franklin-Silvermann aguja para biopsia.....	206	gancho para traqueotomia Iterson.....	477	gubia Alexander.....	259
Frazier elevador para duramadre.....	333	gancho para traqueotomia Jackson.....	476	gubia Brünings-Lucas.....	260
Frazier ganchito.....	149	gancho para traqueotomia News.....	477	gubia Cobb.....	262
Frazier separador abdominal.....	181	gancho REDA.....	150	gubia Hibbs.....	265
Frazier/Fergusson tubo de aspiracion.....	337	gancho Rollet.....	375	gubia Lexer.....	263
Freeman separador.....	198	gancho Rosen.....	419	gubia Lexer Mini.....	263
Freeman tijera face lift.....	73	gancho Shambaugh.....	419	gubia para cuerpos extraños Ellis.....	374
Freer cincel nasal.....	442/1	gancho Sinskey.....	376	gubia para cuerpos extraños Walton.....	374
Freer cincel para el tabique nasal.....	439	ganchos.....	419	gubia Partsch.....	259
Freer cuchillo para tabique nasal.....	434	garrote de madera Maulder.....	459	gubia Smith-Petersen.....	261
Freer elevador para el tabique nasal.....	437	Gass gancho.....	376	gubia Stille.....	260
Freer gancho para la piel.....	448	Gauss pinza para pericraneio.....	605	gubia Zielke.....	264
FRENZEL anteojos para nistagmo.....	20	Gelpi separador perineal.....	189/1, 189/2	guia-conductora DeMartel.....	330
Frenzel baja-lengua.....	451	Gemini pinza hemostatica.....	115	guia-conductora para clavos medulares.....	321
Friedmann especulo.....	577	Gerald pinza de diseccion.....	86, 87	Guilen legra de succion.....	433/1
Friedmann mini pinza gubia.....	234	Gerster barra de traccion.....	250	Guthrie ganchito.....	149
Friedmann pinza gubia.....	234	Gerzog martillo.....	270	Guyon buja dilatadora.....	554
Fritsch separador.....	163	Giertz-Stille costotomo.....	481	Guyon mandril para cateter.....	554
Frykholm pinza gubia.....	240	Gigli mango para sierra hilo.....	332	Guyon pinza hemostatica.....	122
Fuchs pinza capsular.....	391	Gill cuchillo corneal.....	373	Guyton-Lundsgaard esclerotomo.....	373
Fuchsigs pinza hemostatica.....	113	Gill pinza para iris.....	384		
		Gill-Arruga pinza capsular.....	390	H	
		Gill-Hess pinza para iris.....	384	Haberer espátula abdominal.....	143/1
G		Gillies gancho para la piel.....	448	Haglund-Stille separador para yesos.....	232
Gallaher lima para seno.....	446	Gillies pinza de diseccion.....	86	Haight separador costal.....	487
ganchito Frazier.....	149	Gillies porta aguja.....	212	Hajek cincel nasal.....	442/1
ganchito Graefe.....	149	Gil-Vernet separador.....	152	Hajek martillo.....	273
ganchito Guthrie.....	149	Glover clamp atrauma Bulldog.....	100, 103	Hajek-Ballenger elevador para el tabique nasal.....	439
ganchito Joseph.....	149	Glover pinza para uso multiple.....	515	Hajek-Kofler pinza cortante.....	429
ganchito Kleinert-Kutz.....	149	Gluck costotomo.....	480	Hajek-Kofler pinza sacabocado.....	431
ganchito Lahay.....	149	Goelet separador.....	141	Halle cucharrilla cortante.....	253
ganchito nasal Fomon.....	447/1	Goldman-Fox tijera para encias.....	67	Halle elevador para el tabique nasal.....	437
gancho abotonado Lucae.....	409	Gomel micro tijera.....	80	Halsey porta aguja.....	208
gancho abotonado Wagener.....	409	Gomel pinza para microcirugia.....	96	Halsted-Mosquito pinza hemostatica.....	105
gancho auricular Day.....	409	goniometro MOELTGEN.....	25	Hank dilatador uterino.....	580
gancho Barbara.....	419	goniometro para dedos.....	25	Hargis separador para el borde anterior.....	463
gancho Clayman.....	376	GOOD tijera para amigdalas.....	59	Hargis separador para el cuerpo mandibular.....	463/6
gancho cutaneo Kliner.....	608	Goodell dilatador uterino.....	581	Harken pinza auricular.....	503
gancho de decapitacion Braun.....	607	Gorney disector.....	277	Harms sonda.....	381
gancho de menton Obwegeser.....	461	Gorney tijera face lift.....	73	Harrington pinza bronquial.....	490
gancho extractor.....	322	Gosset separador abdominal.....	181	Harrington separador.....	147
gancho Gass.....	376	Gourdet curetas uterinas.....	599	Harrington-Pemberton separador.....	147
gancho Kirschner.....	313	Gradle pinza depilatoria.....	395	Hartmann baja-lengua.....	452
gancho Klapp.....	150	GRADLE tijera para oftalmologia.....	57	Hartmann canula.....	433
gancho Knapp.....	375	Graefe blefarostato.....	370	Hartmann cateter auricular.....	408
gancho McGee.....	419	Graefe cucharrilla para cataratas.....	377	Hartmann diapason.....	403
gancho muscular.....	267	Graefe cuchillo para cataratas.....	371	Hartmann especulo auricular.....	399
gancho muscular Green.....	375	Graefe cuchillo para discision.....	372	Hartmann especulo nasal.....	422
gancho obstetrico Smellie.....	605	Graefe ganchito.....	149	Hartmann pinza auricular.....	411
gancho para cristalino Stevens.....	375	Graefe gancho para estrabismo.....	375	Hartmann pinza hemostatica.....	104
gancho para duramadre.....	335	Graefe pinza de diseccion.....	83	Hartmann pinza nasal.....	424, 427
gancho para dura-madre Adson.....	329	Graefe pinza para fijacion.....	389	Hartmann pinza para polipos.....	412
gancho para duramadre Fisch.....	335				



Hartmann-Halle especulo nasal.....	421	Huber mango universal.....	472	Joseph sierra nasal.....	446
Hartmann-Hoffmann pinza para polipos.....	412	Hudson perforador de mano.....	299	JOSEPH tijera para cirugia.....	54
Hartmann-Wullstein pinza para polipos.....	412	Hulka pinza uterina.....	583	Judd-Allis pinza intestinal.....	538
Haugh pinza auricular micro.....	414	HUMBY dermatomo.....	50	Judd-Masson separador vesical.....	552
Hayes pinza para anastomosis del recto.....	545	Hunter pinza para espinas.....	91	juego de laringoscopia FOREGGER.....	31
Heaney pinza para histerectomia.....	126	Hurd elevador para amigdales.....	465	juego de laringoscopia McINTOSH.....	31
Heaney porta aguja.....	210	I.....		juego de manicura para enfermeras.....	609
Heaney separador.....	164	I.U.D. gancho para sacar el inserto.....	593	juego para varices NABATOFF.....	201
Heany cureta para biopsia.....	587	iman ocular REDA.....	395	Juers pinza auricular micro.....	414
Heany-Ballentine pinza para histerectomia.....	127	impactor final Kuentscher.....	321	Jurasz pinza para polipos laringeos.....	471
Heath martillo.....	273	impactor/extractor para clavos.....	321, 322	K.....	
Heath tijera para ligadura.....	66	Inge separador para cuerpo vertebral.....	339	Kabierske lanzapolvo.....	405
Hebra cucharilla para chalazion.....	377	Instru Care aceite para instrumentos.....	634	Kader espátula abdominal.....	143/1
Hegar dilatador uterino.....	578, 579	instrumento para circuncision.....	556	Kallmorgen especulo vaginal.....	573
Hegebarth pinza para aplicar agrafes.....	224	instrumento para circuncision Mogen.....	556	Kalt pinza capsular.....	391
Heifetz espátula cerebral.....	369	instrumento para cuerpo extraños (doble) Dix.....	380	Kalt porta aguja.....	214
Heiming pinza para calculos renales.....	536	instrumento para cuerpos extraños La Force.....	374	Kalt-Arruga porta aguja.....	214
Heiss pinza hemostatica.....	112	instrumento para el fragmento de la uña.....	612/1	Kane clamp umbilical.....	605
Heister abre-boca.....	454	instrumento para varices Varady.....	202	Kantowitz pinza hemostatica.....	119/1
hemostatico.....	258, 259	instrumento para vendaje enyesado REDA.....	232	Kaye tijera face lift.....	73
hemostatico Caspar.....	258	instrumentos para manicura.....	612, 612/1	Kelly Grip separador.....	142
Henke elevador para amigdales.....	465	instrumentos para medir.....	594	Kelly pinza hemostatica.....	106
Henley separador.....	170	instrumentos para traqueotomia.....	475	Kelly pinza para polipos uterinos.....	585
Hennig separador para yesos.....	232	Iowa pinza uterina.....	584	Kelly protoscopia.....	562, 563
Hepp-Scheidel micro tijera.....	78	IRIS tijera para cirugia.....	54	Kelly separador.....	142, 164
Herrick pinza para pediculo.....	123	Iris tijera supercut.....	72	Kelly tijera vascular.....	61
Hess pinza capsular.....	391	Israel separador.....	162	Kelly-Rankin pinza hemostatica.....	106
Hess pinza para iris.....	384	Iterson gancho para traqueotomia.....	477	Kern pinza para hueso.....	244
Hess separador para la raiz de nervios.....	329/1	Ives-Fansler anoscopio.....	562	Kerrison pinza cortante.....	428
Heymann pinza nasal.....	425	Iwanson calibrador decimal.....	624	Kevorkian cureta para biopsia.....	587
HEYMANN tijera nasal.....	58	J.....		Kevorkian pinza para biopsia.....	589, 591
Heymann-Knight pinza nasal.....	425	Jackson especulo vaginal.....	573	Kevorkian-Pacific pinza para biopsia.....	592
Heywood-Smith pinza hemorroidal.....	567	Jackson gancho para traqueotomia.....	476	Key elevador.....	282
Hibbs cincel.....	265	JACKSON laringoscopia.....	37	Keyes trepano.....	608
Hibbs gubia.....	265	Jackson pinza de agarre para tendones.....	292	Kielland forceps obstetrico.....	602
Hibbs osteotomo.....	265	Jackson pinza para taponos.....	471	Kielland-Luikart forceps obstetrico.....	603
Hibbs separador.....	164	JACKSON portador de luz.....	37	Killian (Eicken) canula irrigacion.....	433
Hill-Ferguson especulo rectal.....	560	Jackson separador traqueal.....	476	Killian canula.....	433/1
hilos para huesos.....	314	Jackson-Burrows separador.....	189/2	Killian cincel nasal.....	442/1
Hirschman espátula para ciclodialis.....	379	Jacobs pinza uterina.....	583	Killian elevador para el tabique nasal.....	438, 439
Hirschmann anoscopio.....	562	Jacobsen porta aguja.....	215	Killian especulo nasal.....	423
histerometro Collin.....	586	Jacobson porta aguja.....	257	Killian tijera para septo.....	471
histerometro Martin.....	586	Jacobson cucharilla cortante.....	257	Killian-Claus cincel nasal.....	442/1
histerometro Sims.....	586	Jacobson sonda abotonada.....	335	Kilner gancho cutaneo.....	608
histerometro Valleix.....	586	Jaeger cuchillo de discision.....	372	Kilner porta aguja.....	212
Hoen elevador para duramadre.....	333	Jaeger placa para parpado.....	371	Kilner retractor nasal.....	447/1
Hoesel porta aguja.....	213	Jameson gancho para estrabismo.....	375	KILNER tijera para cirugia.....	54
Hofer separador para pilar.....	465	Jansen pinza para estrabismo.....	385	Kilner/Ragnell tijera supercut.....	72
Hoffmann cierra-tubos.....	624	Jansen cucharilla cortante.....	257	Kilner-Doughty abre-boca.....	456
Hohmann elevador.....	284, 285	Jansen pinza gubia.....	237	Kirby-Arthur pinza para fijacion.....	385
Hohmann mini elevador.....	286	Jansen pinza nasal.....	424	Kirk martillo.....	270
hoja de repuesto para dermatomo.....	49	Jansen separador.....	168	Kirschner alambre.....	306, 307
hoja de repuesto para dermatomo.....	50	Jansen-Gruenwald pinza nasal.....	424	Kirschner estribo para extension.....	312
hojas de afeitar.....	45	Jarcho pinza uterina.....	583	Kirschner gancho.....	313
hojas de bisturi, esteril.....	42	Javid pinza para shunt carotido.....	511	Kirschner perforador de mano.....	299
hojas de bisturi, esteril, desechables.....	43	Jennings abre-boca.....	454	Kirschner separador abdominal.....	185, 187, 187/1
hojas de cincel intercambiables.....	266	Jensen canula capsular.....	394	Kirschner sonda conductora.....	221
hojas de osteotomo intercambiables.....	266	jeringa.....	406, 407	Kirschner soporte de esterilizacion para alambres.....	305
Hoke osteotomo.....	265	jeringa auricular Reiner.....	406	Kirschner U.S. estribo para extension.....	312
HOLINGER laringoscopia.....	37	jeringa para amigdales.....	470	Klapp gancho.....	150
HOLINGER portador de luz.....	37	Jobson-Horne porta-algodon.....	203	Kleinert-Kutz ganchito.....	149
Holsher separador para la raiz de nervios.....	329/1	Johns-Hopkins pinza hemostatica.....	120	Kleinert-Kutz pinza de agarre para tendones.....	294
Holth pinza para capsuloidectom.....	380	Johns-Hopkins serra-fina.....	104	Kleinert-Kutz pinza gubia.....	237
Holzbach pinza para histerectomia.....	126	Jones pinza de campo.....	132	KLEINSASSER anillo.....	36
Holzheimer separador.....	168	Jones-Clip pinza de campo.....	132	KLEINSASSER articulacion.....	36
Hopkins cuchillo para vendaje enyesado.....	233	Jonson porta aguja.....	211	KLEINSASSER canula de inyeccion.....	36
horquilla fijadora Burch.....	373	JORGENSEN tijera de diseccion.....	53	KLEINSASSER canula de succion.....	36
Horsley elevador para duramadre.....	333	Joseph bisturi nasal.....	434, 435	KLEINSASSER laringoscopia operativo.....	35
Hösel separador.....	167	Joseph elevador para el tabique nasal.....	437	KLEINSASSER portadore de luz fria.....	36
House cureta.....	420	Joseph ganchito.....	149	KLEINSASSER soporte pectoral.....	36
House sonda para mesurar.....	420	Joseph lima para hueso.....	443	Klein Schmidt pinza para apendice.....	544
House tubo de aspiracion.....	337/2	Joseph periostotomo.....	277	Klinikum Berlin pinza cierra-tubo.....	129
Howarth elevador para el tabique nasal.....	438				



Klinkenbergh-Loth tijera vasija.....	65/2	Lang diseccador para el saco lacrimal.....	378	Littauer pinza depiladora.....	395
Knapp cucharilla para cataratas.....	378	Lange gancho para las alas de la nariz.....	448	Littauer pinza para polipos.....	425
Knapp cuchillo para iris.....	372	Lange punta de pinza.....	472	Littauer tijera para ligadura.....	66
Knapp gancho.....	375	Langè-Hohmann elevador.....	286	Little separador.....	157
KNAPP tijera para cirugia.....	55	Langenbeck asa.....	409	LITTLE tijera para cirugia.....	55
Knapp-Luer pinza para tracomia.....	393	LANGENBECK cuchillo para amputacion.....	44	Littlewood pinza intestinal.....	538
Knight pinza nasal.....	425	LANGENBECK cuchillo para reseccion.....	47	llave de tuerca.....	313
Knowles tijera para vendaje.....	70	Langenbeck periostotomo.....	275	Locke espátula.....	612/1
Kocher espátula vesical.....	552	Langenbeck pinza para hueso.....	243	Lockhart-Mummary sonda para fistula.....	200
Kocher pinza hemostatica.....	108	Langenbeck porta aguja.....	213	Locklin tijera para encias.....	69
Kocher pinza intestinal.....	540	Langenbeck separador.....	158, 159	Lockwood-Allis pinza intestinal.....	538
Kocher separador.....	155	Langenbeck sierra para amputacion.....	296	London-College pinza dental.....	93
Kocher separador.....	159, 160, 163	Langenbeck-Green separador.....	153	Lopez-Reinke elevador para amigdales.....	465
Kocher sonda para bocio.....	479	lanzapolo Kabierske.....	405	Lorenz tijera para vendaje.....	70
Kocher-Langenbeck separador.....	159	laringoscopio FOREGGER.....	29	Lorna pinza para campo.....	133
Koenig sonda conductora.....	221	laringoscopio HOLINGER.....	37	Loute tensor de cierra-hilo.....	315
Koerte separador.....	162	laringoscopio JACKSON.....	37	Love separador para la raiz de nervios.....	329/2, 330
Kogan especulo endocervical.....	577	laringoscopio McINTOSH.....	29	Love separador para uvula.....	465
König elevador.....	284	laringoscopio MILLER.....	30	Love-Gruenwald pinza cortante para laminectomia.....	340
König periostotomo.....	276	laringoscopio operativo KLEINSASSER.....	35	Lovelace pinza hemostatica.....	109
König separador.....	153	Larsen pinza para tendones.....	292	Lovelace pinza para coger el pulmon.....	490
Koos micro cuchillo.....	335	Lawrence pinza hemostatica.....	119	Lower pinza hemostatica.....	120
Körte separador.....	143/1	Lebsche cincel de esternon.....	267	Lowman pinza para huesos.....	249
Krause cierra-nudo auricular.....	411	Lees pinza bronquial.....	504	Lowman-Hoglund pinza para huesos.....	249
Krause polipotomo.....	433/2	legra corneal Kuhnt.....	373	Lubet-Barbon pinza nasal.....	424
Krause punta de pinza.....	472	legra de succion Guilen.....	433/1	Luc pinza nasal.....	426
Krause-Voss polipotomo.....	433/2	Legueu espátula vesical.....	552	Lucae aguja para paracentesis.....	408
Krayenbühl gancho para nervios.....	336	Legueu separador vesical.....	553	Lucae diapason.....	404
Kristeller especulo vaginal.....	572	Leksell (Stille) pinza gubia.....	240	Lucae gancho abotonado.....	409
Kroenig baja-lengua.....	451	Leland-Jones pinza para vasos perifericos.....	494	Lucae martillo.....	271
Kronecker aguja para ligadura.....	219	Lempert cucharilla cortante.....	256	Lucae pinza auricular.....	410
Kuentscher impactor final.....	321	Lempert elevador.....	420	Luer canula para traqueotomia.....	479
Kuglen manipulador.....	376	Lempert pinza gubia.....	237	Luer pinza gubia.....	236
Kühnt legra corneal.....	373	Lerche pinza de diseccion.....	83	Luer separador.....	140
Kümmel espátula abdominal.....	144	Leriche pinza hemostatica.....	111	Luer-Koerte cuchara para calculos biliares.....	533
Kümmel separador abdominal.....	143/2	Leriche separador intestinal.....	143/2	Luikart forceps obstetrico.....	603
Küntscher extractor.....	322	Lester pinza para fijacion.....	389	Luikart-Bill tractor.....	604
Küntscher perforador para femur.....	321	Levinson aguja para cuerpos extraños.....	374	Lundsgaard esclerotomo.....	373
Küntscher perforador para la cavidad medular.....	321	Lewin pinza para hueso.....	246	Luniatschek tamponador.....	465
L.....		Lewis (Joseph) lima nasal.....	443	M.....	
L&M separador intra oral.....	463/4	LEXER BABY tijera de diseccion.....	53	MAGILL pinza para introducir cateter.....	28
La Force instrumento para cuerpos extraños.....	374	Lexer gubia.....	263	malla de alambre.....	311
La Grange tijera para encias.....	69	Lexer Mini gubia.....	263	Maltz lima nasal.....	443, 444
La Grange tijera supercut.....	72	Lexer Mini osteotomo.....	263	mandril.....	300
Laborde dilatador traqueal.....	476	Lexer osteotomo.....	263	mandril para cateter Guyon.....	554
Lacrimal canula.....	394	LEXER tijera de diseccion.....	53	mango bisturi MINI.....	41
LaForce adenotomo.....	450	Leyla separador de sistema.....	368-368/4	mango bisturíes.....	38-41
Lahey gancho.....	149	lezna Obwegeser.....	463, 463/3	mango con iluminacion para proctoscopia Morgan.....	565
Lahey pinza para agarrar el bocio.....	479	Lichtenberg porta aguja.....	213	mango de aspiracion Wullstein.....	338
LAHEY pinzas hemostáticas.....	119/2, 120	Lichtwitz canula de puncion.....	433	mango de bisturi COLLIN.....	40
Lahey separador.....	157	Lichtwitz trocar para seno maxilar.....	204	mango de pila para laringoscopia.....	32, 33, 34
Lambert pinza para chalazion.....	393	Liebermann blearostato.....	371	mango para cincel/gubia.....	266
Lambert-Kay pinza para anastomosis.....	505	ligador para hemorroides.....	568	mango para espejo laringeo.....	473
Lambert-Lowman pinza para huesos.....	249	ligador para hemorroides McGivney.....	568	mango para sierra hilo Gigli.....	332
Lambotte osteotomo.....	261	ligador para hemorroides Rudd.....	568	mango universal Huber.....	472
Lambotte periostotomo.....	274	lima nasal Aufrecht.....	443	manos de acople rapido.....	301
Lambotte pinza para hueso.....	244	lima nasal Cottle (Maltz).....	444	manguito de cierre Stone-Watt.....	545
lampara frontal CLAR.....	22	lima nasal Fomon.....	444, 445	manipulador Kuglen.....	376
lampara halogena.....	29	lima nasal Lewis (Joseph).....	443	manometro.....	295
Lancaster blefarostato.....	371	lima nasal Maltz.....	443, 444	manopla de plomo.....	250
Landau especulo vaginal.....	577	lima para hueso Joseph.....	443	marcador Connin-Amsler.....	380
Landolt pinza para tumores.....	341	lima para huesos.....	294	Marquardt pinza gubia.....	239
Lane destornillador.....	323, 324	lima para huesos.....	612/1	Marschik pinza para amigdales.....	468
Lane elevador.....	290	lima para huesos Putti.....	294	Martel pinza hemostatica.....	110
Lane palanca para doblar placas.....	325	lima para seno Gallaher.....	446	martillo.....	270, 271, 272, 273
Lane pinza de campo.....	133	lima para uñas.....	610	Lister (Sinus) pinza porta esponja.....	272
Lane pinza de diseccion.....	84	lima para huesos.....	137	Lister tijera para vendaje.....	69/1
Lane pinza estomacal.....	547	Lister-Burch blefarostato.....	72	Lister tijera supercut.....	72
Lane pinza para hueso.....	244	LISTON cuchillo para amputacion.....	44	Lister-Burch blefarostato.....	370
Lane pinza para sostener placas.....	325	Liston pinza cortante para huesos.....	241	LISTON pinza para amputacion.....	44
Lane pinza para sostener tornillos.....	325	Littauer pinza auricular.....	411	Liston pinza cortante para huesos.....	241
Lane Trethowan elevador.....	290			Littauer pinza auricular.....	411



martillo de percusion TROEMNER.....	24	Mellinger-Axenfeld blefarostato.....	370	Moynihan pinza de campo.....	133
martillo Gerzog.....	270	Menghini aguja para biopsia.....	206	Moynihan pinza hemostatica.....	120
martillo Hajek.....	273	meniscotomo Neff.....	292	Mueller blerlarostato.....	371
martillo Heath.....	273	meniscotomo Smillie.....	292	Muenchen Mod. cuerta para biopsia.....	587
martillo Kirk.....	270	Mercedes separador toracico.....	489	Müller aproximador.....	364
martillo Lucae.....	271	Meriam pinza dental.....	93	Müller clips para vasos.....	365
martillo Mead.....	271	Metzenbaum porta aguja.....	211	Murdoch blefarostato.....	370
martillo Ombredanne.....	273	METZENBAUM tijera de diseccion.....	53/1	Murphy separador.....	156
martillo Partsch.....	271	METZENBAUM tijera para cirugia.....	54	Murphy-Lane elevador.....	283
martillo Quisling.....	271	Metzenbaum tijera supercut.....	71	Museux pinza uterina.....	583
martillo Williger.....	271	Meyering separador.....	157, 177, 180	Myles pinza nasal.....	427
Martin histormetro.....	586	Meyhoefer cucharilla para chalazion.....	377		
Martin pelvimetro.....	605	Michel agrafe.....	224	<b>N</b>	
Martin pinza para cartilago.....	246	Michel espejo laríngeo.....	423	NABATOFF juego para varices.....	201
Martin separador.....	175/1	Michel pinza para aplicar agrafes.....	224	Naegele forceps obstetrico.....	602
Martin-Cartilage tijera.....	65/1	Michel pinza para aplicar y quitar agrafes.....	224	Nager aguja para sutura del paladar.....	466
Martini cucharilla cortante.....	257	micro cuchillo Koos.....	335	Nager separador para paladar.....	465
Masing retractor nasal.....	447	Micro Friedmann pinza gubia.....	234	navaja.....	49
Masing-Neivert retractor nasal.....	447	micro pinza auricular.....	413, 414, 415	Neff meniscotomo.....	292
Masson porta aguja.....	210	micro pinzas.....	86, 94	Negus pinza para coger amígdalas.....	467
Maxtin pinza muscular.....	479	micro porta aguja Barraquer.....	216, 217	Negus soporte de pecho.....	459
Mathieu especulo rectal.....	560	micro porta aguja Barraquer-Troutman.....	216	Neivert porta aguja.....	208
Mathieu pinza para cuerpos extraños.....	553/1	micro porta aguja Castroviejo-Standard.....	216	Neivert-Anderson cincel nasal.....	442
Mathieu porta aguja.....	213	micro tijera Circumflex.....	76	Nelaton sonda.....	199
Mathieu separador.....	141	micro tijera Gommel.....	80	Nelson (Standard) trocar abdominal.....	204
Mathieu-Olsen porta aguja.....	212	micro tijera Hepp-Scheidel.....	78	Nelson aguja para ligadura.....	219
Matson periostotomo.....	279	micro tijeras.....	76, 77, 78	Nelson pinza de diseccion.....	89
Matson-Alexander periostotomo.....	279	micro tijeras REDA.....	77, 80	Nelson trocar.....	205
Maunder garrote de madera.....	459	Microvascular porta aguja.....	210	Neonatal pinza vascular.....	523
Maxi Grasper pinza para biopsia.....	593	Middeldorf separador.....	160	News gancho para traqueotomia.....	477
May oftalmoscopia UNI II.....	14	Middleton-Jansen pinza para tabique nasal.....	430	Nissen pinza hemostatica.....	113
Mayfield pinza gubia.....	238	Mikulicz pinza intestinal.....	543	Norfolk / Norwich separador.....	172
Mayo baja-lengua.....	451	Mikulicz pinza para peritoneo.....	123	Northbert tijera.....	66
Mayo clip para esterilizacion.....	227, 624	Mikulicz separador.....	163	Norwich / Norfolk separador.....	172
Mayo cuchara para calculos biliares.....	534	MILLER laringoscopia.....	30	Noto pinza para polipos uterinos.....	585
Mayo pinza de diseccion.....	89	Milligan elevador para duramadre.....	332	NOVA esfigmomanometro.....	7
Mayo sonda para calculos biliares.....	534	Millin pinza de agarre para capsula.....	550, 551	Novak cureta aspiradora para biopsia uterina.....	587
MAYO tijera de diseccion.....	52	Millin pinza para ligadura.....	551	NOVA-PRESAMETER esfigmomanometro.....	6
Mayo tijera supercut.....	71	Millin pinza para lobo anterior.....	551	Noyes pinza para polipos.....	425
Mayo-Adams separador.....	171	Millin separador cuello vejiga.....	553	Noyes tijera para iris.....	75
Mayo-Blake pinza para calculos biliares.....	531	Millin separador vesical.....	552		
Mayo-collins separador.....	141	MINI mango de bisturi.....	41	<b>O</b>	
Mayo-Guyon pinza hemostatica.....	122	Mini-Lamotte osteotomo.....	262	Obwegeser elevador.....	461
Mayo-Haberisser pinza para torcer hilo.....	319	MINIMUS II esfigmomanometro.....	11	Obwegeser gancho de menton.....	461
MAYO-Hegar porta aguja.....	209	MINIMUS III esfigmomanometro.....	12	Obwegeser lezna.....	463, 463/3
MAYO-NOBLE tijera de diseccion.....	52	Mini-Townsend-Down pinza para biopsia.....	591	Obwegeser osteotomo.....	463
Mayo-Robson pinza intestinal.....	541	Mini-Townsend-Up pinza para biopsia.....	591	Obwegeser osteotomo de hoja.....	464/1
MAYO-STILLE tijera de diseccion.....	52	Mixer Baby pinza hemostatica.....	119/1	Obwegeser periostotomo.....	462
Mayo-Stille tijera supercut.....	71	Mixer pinza hemostatica.....	116, 119/1, 119/2, 120	Obwegeser separador manibular.....	461
Mc Donald elevador.....	283	Mixer pinza para calculos biliares.....	531	Obwegeser separador para partes blandas.....	460
McCullough pinza para estrabismo.....	385	Mixer-O'Shaughnessy pinza hemostatica.....	119/2	Ochsner pinza de diseccion.....	88
McGee gancho.....	419	Mod. Bonn pinza para sutura.....	386	Ochsner trocar.....	205
McGee pinza auricular micro.....	414	Mod. Muenchen cureta para biopsia.....	587	O'Conner gancho para iris.....	375
McGivney ligador para hemorroides.....	568	Mod. Tübingen pinza para ligadura.....	392	Oehler pinza de diseccion.....	81/1
McGivney pinza para hemorroides.....	568	Mod. Tübingen pinza para sutura.....	386	oftalmoscopia May UNI II.....	14
McIndoe pinza cortante para huesos.....	241	Mod. USA tijera para cordon umbilical.....	64	Oldberg pinza cortante para laminectomia.....	341
McIndoe pinza de diseccion.....	85	Mod. Vienna especulo nasal.....	421	oliva auricular.....	406
McIndoe tijera para cartilago.....	65/1	MOELTGEN goniometro.....	25	oliva auricular Politzer.....	406
McINTOSH juego de laringoscopia.....	31	Mogen instrumento para circuncision.....	556	Olivecrona elevador para duramadre.....	332
McINTOSH laringoscopia.....	29	Mollison separador.....	171	Olivecrona espátula cerebral.....	336
McIntyre canula lacrimal.....	394	Molt (Doyen-Jansen) abre-boca.....	454	Olivecrona pinza gubia.....	237
McIvor abre-boca.....	457	Molt periostotomo.....	276	Olivecrona sierra hilo.....	332
McKenty elevador para el tabique nasal.....	437, 438	mondador de tendones Brand.....	294	Olivecrona-Toennis pinza aplicadora.....	326
McKenzie pinza aplicadora.....	326	Moor cuchara para calculos biliares.....	532	Ollier separador.....	162
McLean forceps obstetrico.....	603	Moore perforador de mano.....	298	Olsen-Hegar porta aguja.....	212
McLean-Tucker forceps obstetrico.....	603	Moorfield pinza para sutura.....	392	Ombredanne martillo.....	273
McLean-Tucker-Luikart forceps obstetrico.....	603	Morgan proctoscopia.....	565	osteotomo.....	259-263, 265, 267
McPherson pinza para ligadura.....	392	Moritz-Schmidt baja-lengua.....	452	osteotomo.....	464
Mead martillo.....	271	Morris separador.....	164	osteotomo de hoja Obwegeser.....	464/1
Mead pinza gubia.....	235	Morris-DeBakey pinza para la aorta.....	506	osteotomo Epker.....	464/2
Meeker pinza hemostatica.....	119	Morse separador costal.....	484	osteotomo Hibbs.....	265
Mehdorn pinza para vasos.....	362	Morse-Favaloro separador costal.....	484	osteotomo Hoke.....	265
Mellinger blefarostato.....	370	Moynihan explorador apra calculos biliares.....	532	osteotomo Lambotte.....	261



osteotomo Lexer .....	263	periostotomo Matson .....	279	pinza cortante para huesos Semb .....	242
osteotomo Lexer Mini .....	263	periostotomo Matson-Alexander .....	279	pinza cortante para huesos Stamm .....	241
osteotomo Mini-Lambotte .....	262	periostotomo Molt .....	276	pinza cortante para huesos Stille-Horsley .....	242
osteotomo Obwegeser .....	463	periostotomo Obwegeser .....	462	pinza cortante para huesos Stille-Liston .....	242
osteotomo Stille .....	260	periostotomo Quervain .....	275	pinza cortante para laminectomia Cloward .....	342
Ostroem pinza sacabocado .....	430	periostotomo Sebileau .....	275	pinza cortante para laminectomia Cushing .....	340
O'Sullivan-O'Connor espejulo vaginal .....	576	periostotomo Sedillot .....	274, 275	pinza cortante para laminectomia Ferris-Smith .....	343
O'Sullivan-O'Connor separador abdominal .....	181	periostotomo Seldin .....	277	pinza cortante para laminectomia Love-Gruenwald .....	340
Otis uretrotomo .....	553	periostotomo Semb .....	278	pinza cortante para laminectomia Oldberg .....	341
otoscopio UNI I .....	13	periostotomo Williger .....	276	pinza cortante para laminectomia Schlesinger .....	342
Overholt pinza hemostatica .....	114	Perkins separador .....	168	pinza cortante para laminectomia Spurling .....	340
Overholt-Baby pinza hemostatica .....	114	Perthes escariador .....	304	pinza cortante para laminectomia Wagner .....	343
Overholt-Geissendoerfer pinza hemostatica .....	114	Pestalozza cureta para aborto .....	606	pinza cuticular .....	610
Overholt-Mixer pinza hemostatica .....	115	Petri cubeta .....	620	pinza de agarre .....	305
<b>P</b>					
palanca para doblar placas Lane .....	325	Phaneuf pinza para peritoneo .....	123	pinza de agarre para capsula Millin .....	550, 551
Park blearostato .....	371	Pierce elevador para el tabique nasal .....	438	pinza de agarre para prostata Young .....	550
Parker separador .....	139	Pierce trocar para seno maxilar .....	204	pinza de agarre para tendones .....	292, 293
Parker-Langenbeck / Us Army separador .....	141	pieza de acomplamiento para curetas aspiradoras .....	600	pinza de agarre para tendones Brand .....	293
Partsch cincel .....	259	Pifard cureta para lupus .....	608	pinza de agarre para tendones Caroll .....	293
Partsch gubia .....	259	PINARD estetoscopio .....	23	pinza de agarre para tendones Jackson .....	292
Partsch martillo .....	271	pinza aplicadora .....	104	pinza de agarre para tendones Kleinert-Kutz .....	294
pasador de tendones Bunell .....	294	pinza aplicadora de clips .....	524, 525	pinza de agarre para tendones Steinmann .....	292
Passow cincel tamponador para huesos .....	260	pinza aplicadora McKenzie .....	326	pinza de aplicacion .....	357-360
Patella pinza para hueso .....	248	pinza aplicadora Olivecrona-Toennis .....	326	pinza de campo .....	132, 133
Paton disecador corneal .....	373	pinza aplicadora Raney .....	327	pinza de campo Backhaus .....	132
Paufique cuchillo para queratoplastica .....	373	pinza aplicadora Smithwick .....	326	pinza de campo Backhaus-Clip .....	132
Paufique pinza para ligadura .....	392	pinza aplicadora Sweet .....	326	pinza de campo Bernhard .....	133
Payr pinza intestinal y estomacal .....	548	pinza traumatica Gregory .....	517	pinza de campo Doyen .....	133
Payr sonda conductora .....	221	pinza traumatica REDA .....	111	pinza de campo Jones .....	132
Payr-Baby pinza intestinal y estomacal .....	548	pinza traumatica Rogers .....	127	pinza de campo Jones-Clip .....	132
Pean pinza hemostatica .....	108, 110	pinza auricular Harken .....	503	pinza de campo Lane .....	133
Peck Joseph tijera face lift .....	73	pinza auricular Hartmann .....	411	pinza de campo Moynihan .....	133
Pederson espejulo vaginal .....	570	pinza auricular Littauer .....	411	pinza de campo Peers .....	132
Peers pinza de campo .....	132	pinza auricular Lucae .....	410	pinza de campo Roeder .....	132
Peet escofina nasal .....	446	pinza auricular micro .....	413, 414, 415	pinza de campo Schaedel .....	132
Peet pinza para espinas .....	92	pinza auricular micro Cos .....	414	pinza de campo Tohoku .....	132
Pelkmann pinza porta esponja .....	137	pinza auricular micro Dieter .....	414	pinza de diseccion Adlerkreutz .....	84
pelvimetro Collier .....	605	pinza auricular micro Greven .....	414	pinza de diseccion Adson .....	81/2, 82
pelvimetro Collin .....	605	pinza auricular micro Haugh .....	414	pinza de diseccion Adson-Brown .....	82
pelvimetro Martin .....	605	pinza auricular micro Juers .....	414	pinza de diseccion Adson-DeBakey .....	81/2
Penfield elevador para duramadre .....	333	pinza auricular micro McGee .....	414	pinza de diseccion Bonney .....	88
Pennington elevador para el tabique nasal .....	438	pinza auricular micro Mullen .....	416	pinza de diseccion Brophy .....	84
Pennington pinza hemostatica .....	109	pinza auricular micro Tilly .....	411	pinza de diseccion Brown .....	83
Percy retractor para amputacion .....	296	pinza auricular Wilde (Troeltsch) .....	410	pinza de diseccion Collin-Duval .....	85
perforacraneo Smellie .....	607	pinza autocentradora para sostener huesos REDA .....	247	pinza de diseccion Cushing .....	83
perforador de mano .....	298, 299, 300, 304	pinza bronquial .....	126	pinza de diseccion Cushing-Taylor .....	87
perforador de mano Bunell .....	299	pinza bronquial Finochietto .....	490	pinza de diseccion Duhresen .....	84
perforador de mano Hudson .....	299	pinza bronquial Harrington .....	490	pinza de diseccion Durante .....	88
perforador de mano Kirschner .....	299	pinza bronquial Lees .....	504	pinza de diseccion Duval .....	85
perforador de mano Moore .....	298	pinza bronquial Price-Thomas .....	490	pinza de diseccion Ferris-Smith .....	85
perforador de mano Ralk .....	300	pinza bronquial Semb .....	491	pinza de diseccion Gerald .....	86, 87
perforador de mano REDA .....	300	pinza capsular Arruga .....	391	pinza de diseccion Gillies .....	86
perforador de mano Stille .....	298	pinza capsular Castroviejo .....	391	pinza de diseccion Graefe .....	83
perforador de mano Stille-Sherman .....	298	pinza capsular Elschmig .....	391	pinza de diseccion Lane .....	84
perforador inicial Crutchfield .....	327	pinza capsular Fuchs .....	391	pinza de diseccion Lerche .....	83
perforador medular .....	322	pinza capsular Gill-Arruga .....	390	pinza de diseccion Mayo .....	89
perforador para femur Kuntscher .....	321	pinza capsular Hess .....	391	pinza de diseccion McIndoe .....	85
perforador para la cavidad medular Kuntscher .....	321	pinza capsular Kalt .....	391	pinza de diseccion modelo ruso .....	85
periostotomo .....	274-280	pinza capsular Schweigger .....	391	pinza de diseccion modelo Strassburger .....	89
periostotomo Alexander .....	276	pinza capsular Terson .....	391	pinza de diseccion Nelson .....	89
periostotomo Cobb .....	280	pinza cierra-tubo .....	129	pinza de diseccion Ochsner .....	88
periostotomo Dingman .....	463	pinza cierra-tubo Bülöw-Gunar-Hey .....	130	pinza de diseccion Oehler .....	81/1
periostotomo Doyen .....	278	pinza cierra-tubo Klinikum Berlin .....	129	pinza de diseccion Potts-Smith .....	81, 81/1
periostotomo Farabeuf .....	274	pinza cierra-tubo Presbyterian .....	129	pinza de diseccion Semken .....	86
periostotomo Farabeuf-Collin .....	274	pinza circular .....	432	pinza de diseccion Singley .....	88
periostotomo Fomon .....	277	pinza cortante Hajek-Koffler .....	429	pinza de diseccion Standard .....	81, 81/1
periostotomo Hargis .....	463/2	pinza cortante Kerrison .....	428	pinza de diseccion Stille .....	81, 81/1
periostotomo Joseph .....	277	pinza cortante para hipofisis .....	341	pinza de diseccion Stille-Barraya .....	88
periostotomo König .....	276	pinza cortante para huesos Böhler .....	241	pinza de diseccion Taylor .....	87
periostotomo Lambotte .....	274	pinza cortante para huesos Cottle-Kazanjan .....	241	pinza de diseccion USA .....	81, 81/1
periostotomo Langenbeck .....	275	pinza cortante para huesos Liston .....	241	pinza de diseccion Wagenstein .....	89
		pinza cortante para huesos McIndoe .....	241	pinza de diseccion Waugh .....	83
		pinza cortante para huesos Ruskin-Liston .....	241	pinza de proteccion Adson .....	298



pinza de reduction REDA .....	247	pinza hemostatica Lahey .....	119/2, 120	pinza nasal Takahashi .....	427
pinza de relojero .....	90	pinza hemostatica Lawrence .....	119	pinza nasal Troeltsch .....	424
pinza de traccion craneal Crutchfield .....	327	pinza hemostatica Leriche .....	111	pinza nasal Watson-Williams .....	428
pinza dental London-College .....	93	pinza hemostatica Lovelace .....	109	pinza nasal Weil-Blakesley .....	426
pinza dental Meriam .....	93	pinza hemostatica Lower .....	120	pinza nasal Westmacott .....	424
pinza depilatoria Barraquer .....	395	pinza hemostatica Martel .....	110	pinza para aborto Saenger .....	606
pinza depilatoria Beer .....	395	pinza hemostatica Mayo-Guyon .....	122	pinza para aborto Winter .....	606
pinza depilatoria Douglas .....	395	pinza hemostatica Meeker .....	119	pinza para agarrar el bocio Lahey .....	479
pinza depilatoria Gradle .....	395	pinza hemostatica Mixer .....	116, 119/1, 119/2, 120	pinza para amigdalas Marschik .....	468
pinza depilatoria Littauer .....	395	pinza hemostatica Mixer Baby .....	119/1	pinza para anastomosis Beck .....	516, 520
pinza depilatoria REDA .....	395	pinza hemostatica Mixer-O'Shaugnessy .....	119/2	pinza para anastomosis Cooley .....	519, 520
pinza estomacal Lane .....	547	pinza hemostatica Moynihan .....	120	pinza para anastomosis Cooley-Derra .....	519
pinza gubia Adson .....	236	pinza hemostatica Nissen .....	113	pinza para anastomosis De Martel-Wolfson .....	546
pinza gubia Bane-Hartmann .....	237	pinza hemostatica Overholt .....	114	pinza para anastomosis DeBakey .....	505, 515
pinza gubia Beyer .....	237, 238	pinza hemostatica Overholt-Baby .....	114	pinza para anastomosis del recto Hayes .....	545
pinza gubia Blumenthal .....	236	pinza hemostatica Overholt-Geissendoerfer .....	114	pinza para anastomosis Derra .....	515
pinza gubia Böhler .....	238	pinza hemostatica Overholt-Mixer .....	115	pinza para anastomosis Lambert-Kay .....	505
pinza gubia Cleveland .....	235	pinza hemostatica Pean .....	108, 110	pinza para anastomosis Potts .....	493
pinza gubia Echlin .....	240	pinza hemostatica Pennington .....	109	pinza para aneurisma de la aorta DeBakey .....	496, 497, 498
pinza gubia Friedmann .....	234	pinza hemostatica Pratt .....	110	pinza para aneurisma DeBakey-Bahnsen .....	506
pinza gubia Friedmann mini .....	234	pinza hemostatica Providence-Hospital .....	106	pinza para apendice Allen .....	544
pinza gubia Frykholm .....	240	pinza hemostatica Roberts .....	117	pinza para apendice Kleinschmidt .....	544
pinza gubia Jansen .....	237	pinza hemostatica Rochester-Carmalt .....	109	pinza para aplicar agrafes Childe .....	224
pinza gubia Kleiner-Kutz .....	237	pinza hemostatica Rochester-Ochsner .....	108	pinza para aplicar agrafes Hegebarth .....	224
pinza gubia Leksell (Stille) .....	240	pinza hemostatica Rochester-Pean .....	108	pinza para aplicar agrafes Michel .....	224
pinza gubia Lempert .....	237	pinza hemostatica Rumel .....	117	pinza para aplicar agrafes Wachenfeldt .....	224
pinza gubia Luer .....	236	pinza hemostatica Sarot .....	118	pinza para aplicar y quitar agrafes Michel .....	224
pinza gubia Marquardt .....	239	pinza hemostatica Spencer-Wells .....	109	pinza para arrancar uñas Radolf .....	297
pinza gubia Mayfield .....	238	pinza hemostatica Stille .....	122	pinza para arrancar vendaje enyesado Wolff .....	233
pinza gubia Mead .....	235	pinza hemostatica Toennis .....	117	pinza para biopsia Alexander .....	589
pinza gubia Micro Friedmann .....	234	pinza hemostatica Tuffier .....	110	pinza para biopsia Baby Burke .....	590
pinza gubia Olivecrona .....	237	pinza hemostatica Wikstroem .....	117	pinza para biopsia Baby-Tischler .....	592
pinza gubia Ruskin .....	239	pinza hemostatica Willet Martel .....	110	pinza para biopsia Burke .....	590
pinza gubia Sauerbruch .....	240	pinza hemostatica Zenker .....	118	pinza para biopsia Eppendorfer .....	590
pinza gubia Scaglietti .....	240	pinza intestinal Allis .....	537	pinza para biopsia Faure .....	588
pinza gubia Semb .....	240	pinza intestinal Allis-Adair .....	537	pinza para biopsia Kevorkian .....	589, 591
pinza gubia Smith-Petersen .....	238	pinza intestinal Allis-Baby .....	537	pinza para biopsia Kevorkian-Pacific .....	592
pinza gubia Stellbrink .....	234	pinza intestinal Babcock .....	539	pinza para biopsia Maxi Grasper .....	593
pinza gubia Stille-Luer .....	239	pinza intestinal Baby-Kocher .....	540	pinza para biopsia Mini-Townsend-Down .....	591
pinza gubia Stille-Ruskin .....	239	pinza intestinal Boys-Allis .....	538	pinza para biopsia Mini-Townsend-Up .....	591
pinza gubia Zaufal-Jansen .....	238	pinza intestinal Brunner .....	543	pinza para biopsia rectal Turrel .....	567
pinza hemorroidal Heywood-Smith .....	567	pinza intestinal Doyen .....	540	pinza para biopsia rectal Yeoman .....	566, 567
pinza hemostatica Adson .....	112, 113	pinza intestinal Doyen-Baby .....	540	pinza para biopsia Schubert .....	588
pinza hemostatica Adson Baby .....	113	pinza intestinal Fehland .....	542	pinza para biopsia Schumacher .....	588, 589
pinza hemostatica atraumatica DeBakey-Mosquito .....	509	pinza intestinal Judd-Allis .....	538	pinza para biopsia Serpentine-Grasper .....	593
pinza hemostatica atraumatica DeBakey-Pean .....	513	pinza intestinal Kocher .....	540	pinza para biopsia Thomas-Gaylor .....	588
pinza hemostatica atraumatica DeBakey-Rankin .....	512	pinza intestinal Littlewood .....	538	pinza para biopsia Tischler-Down .....	591
pinza hemostatica Bainbridge .....	119/2	pinza intestinal Lockwood-Allis .....	538	pinza para biopsia Tischler-Kevorkian .....	592
pinza hemostatica Bengolea .....	112	pinza intestinal Mayo-Robson .....	541	pinza para biopsia Tischler-Morgan .....	590, 591
pinza hemostatica Birkett .....	116	pinza intestinal Mikulicz .....	543	pinza para biopsia Tischler-Up .....	591
pinza hemostatica Bridge .....	116	pinza intestinal Resano .....	542	pinza para biopsia Townsend .....	591
pinza hemostatica Chaput .....	110	pinza intestinal Scudder .....	541	pinza para biopsia van Doren .....	588
pinza hemostatica Collier-Crile .....	106	pinza intestinal Stone-Watt .....	545	pinza para biopsia Wittner .....	589
pinza hemostatica Collin .....	110	pinza intestinal Thoms-Allis .....	538	pinza para bronco-esofagoscopia Chevalier-Jackson .....	473
pinza hemostatica Crafoord .....	118	pinza intestinal y estomacal Payr .....	548	pinza para calculos biliares Blake .....	531
pinza hemostatica Crafoord-Sellors .....	119	pinza intestinal y estomacal Payr-Baby .....	548	pinza para calculos biliares Desjardins .....	531
pinza hemostatica Crile .....	107	pinza maleolar .....	247	pinza para calculos biliares Mayo-Blake .....	531
pinza hemostatica Crile-Rankin .....	107	pinza muscular Berke .....	389	pinza para calculos biliares Mixer .....	531
pinza hemostatica Dandy .....	109	pinza muscular Mastin .....	479	pinza para calculos renales Heimig .....	536
pinza hemostatica Desjardins .....	121	pinza muscular Prince .....	386	pinza para calculos renales Randall .....	535
pinza hemostatica Ferguson .....	109	pinza muscular Snellen .....	393	pinza para campo Bali and Socket .....	133
pinza hemostatica Fuchsig .....	113	pinza nasal Bruenings .....	425	pinza para campo Lorna .....	133
pinza hemostatica Gemini .....	115	pinza nasal Hartmann .....	424, 427	pinza para capsuloridectom Holth .....	380
pinza hemostatica Gray .....	121	pinza nasal Heymann .....	425	pinza para cartilagos Martin .....	246
pinza hemostatica Guyon .....	122	pinza nasal Heymann-Knight .....	425	pinza para cateter Cooley .....	510
pinza hemostatica Halsted-Mosquito .....	105	pinza nasal Jansen .....	424	pinza para cerrar clamps De Martel-Wolfson .....	546
pinza hemostatica Hartmann .....	104	pinza nasal Jansen-Gruenwald .....	424	pinza para cerrar clamps Stone .....	545
pinza hemostatica Heiss .....	112	pinza nasal Knight .....	425	pinza para chalazion Desmarres .....	393
pinza hemostatica Johns-Hopkins .....	120	pinza nasal Lubet-Barbon .....	424	pinza para chalazion Lambert .....	393
pinza hemostatica Kantrowitz .....	119/1	pinza nasal Luc .....	426	pinza para coartacion Potts .....	492
pinza hemostatica Kelly .....	106	pinza nasal Myles .....	427	pinza para coger amigdalas Abraham .....	468
pinza hemostatica Kelly-Rankin .....	106	pinza nasal Schmeden .....	427	pinza para coger amigdalas Ballenger .....	467
pinza hemostatica Kocher .....	108	pinza nasal Struckyen .....	427	pinza para coger amigdalas Blohmke .....	467



pinza para coger amígdalas Colver .....	467	pinza para introducir cateter MAGILL.....	28	pinza para torcer hilo Berry .....	319
pinza para coger amígdalas Negus .....	467	pinza para iris Barraquer (Colibri) .....	384	pinza para torcer hilo Corwin-Hegar .....	319
pinza para coger amígdalas Tyding .....	468	pinza para iris Barraquer-Katzin .....	384	pinza para torcer hilo Mayo-Haberisner .....	319
pinza para coger amígdalas White .....	467	pinza para iris Bishop-Harman .....	386	pinza para tracomma Knapp-Luer .....	393
pinza para coger el pulmon Lovelace .....	490	pinza para iris Colibri .....	384	pinza para tumores Landolt .....	341
pinza para coger las amígdalas Sawtell .....	467	pinza para iris Fischer .....	384	pinza para tumores Yasargil .....	97
pinza para coger las amígdalas Schmidt .....	467	pinza para iris Foerster .....	383	pinza para uso multiple Glover .....	515
pinza para columna Cottle .....	448	pinza para iris Gill .....	384	pinza para uterus Green-Armytage .....	605
pinza para cordón espermático .....	553/2	pinza para iris Gill-Hess .....	384	pinza para vasectomía .....	553/2
pinza para cuerpos extraños Mathieu .....	553/1	pinza para iris Graefe .....	382	pinza para vasos Biemer .....	361
pinza para desechos Sauerbruch .....	227	pinza para iris Hess .....	384	pinza para vasos Mehdorn .....	362
pinza para el pene Stockmann .....	553/1	pinza para iris Stevens .....	383	pinza para vasos periféricos DeBaKey .....	494
pinza para el pene Strauss .....	553/1	pinza para iris Troutman .....	389	pinza para vasos periféricos Leland-Jones .....	494
pinza para el tunel del tendón .....	293	pinza para iris Troutman (Colibri) .....	384	pinza para vasos Satinsky .....	491
pinza para el útero Collin .....	585	pinza para la aorta Dietrich .....	510	pinza porta esponja Bozemann .....	138
pinza para el útero Dartigues .....	585	pinza para la aorta Morris-DeBaKey .....	506	pinza porta esponja Bozemann-Douglas .....	138
pinza para el útero Somer .....	585	pinza para la aorta Subramanian .....	521	pinza porta esponja Cheron .....	137
pinza para enderezar el tabique nasal Asch .....	449	pinza para la aorta Subramanian-Miniature .....	521	pinza porta esponja Collin .....	137
pinza para enderezar el tabique nasal Walsham .....	449	pinza para la aorta Weber .....	501	pinza porta esponja Lister (Sinus) .....	137
pinza para espinas Archer .....	92	pinza para laringe Fraenkel .....	471	pinza porta esponja Pelkmann .....	137
pinza para espinas Carmalt .....	91	pinza para ligadura Ayer .....	393	pinza porta-esponja Duplay .....	134
pinza para espinas Feilchenfeld .....	91	pinza para ligadura DeBaKey .....	493	pinza porta-esponja Gross-Maier .....	134
pinza para espinas Hunter .....	91	pinza para ligadura DeBaKey .....	499, 500	pinza porta-esponja Sims-Maier .....	134
pinza para espinas Peet .....	92	pinza para ligadura McPherson .....	392	pinza sacabocado Citelli .....	430
pinza para espinas Stieglitz .....	92	pinza para ligadura Millin .....	551	pinza sacabocado craneal Cone .....	331
pinza para espinas Virtus (Ralk) .....	92	pinza para ligadura Mod. Tübingen .....	392	pinza sacabocado craneal DeVilbiss .....	332
pinza para esterilización .....	227	pinza para ligadura Paufigue .....	392	pinza sacabocado Hajek-Kofler .....	431
pinza para esterilización Cheatle .....	227	pinza para ligadura y la aorta DeBaKey-Semb .....	499	pinza sacabocado Ostroem .....	430
pinza para esterilización de jeringas Davis .....	227	pinza para lobo anterior Millin .....	551	pinza sacabocado para discos intervertebral .....	
pinza para esterilización Rogge .....	227	pinza para magullar tabique Rubin .....	428	Colclough .....	344/1
pinza para esterilización Universal .....	227	pinza para medicación Bryant .....	137	pinza sacabocado para discos intervertebral .....	
pinza para estrabismo Bonaccolto .....	385	pinza para microcirugía .....	96	Ferris-Smith-Kerrison .....	344, 344/2
pinza para estrabismo Dastoor .....	386	pinza para micro-cirugía de la laringe .....	474	pinza tira-lengua Collin .....	453
pinza para estrabismo Jameson .....	385	pinza para oclusión tangencial DeBaKey-Satinsky .....	502	pinza tira-lengua Young .....	453
pinza para estrabismo McCullough .....	385	pinza para pedículo Herrick .....	123	pinza uterina Barrett .....	582
pinza para fijación Barraquer .....	390	pinza para pericraneos Gauss .....	605	pinza uterina Braun .....	582
pinza para fijación Castroviejo .....	390	pinza para peritoneo Faure .....	123	pinza uterina Czerny .....	584
pinza para fijación Cottle .....	410	pinza para peritoneo Mikulicz .....	123	pinza uterina Duplay .....	582
pinza para fijación Elschrig .....	389	pinza para peritoneo Phaneuf .....	123	pinza uterina Hulka .....	583
pinza para fijación Graefe .....	389	pinza para polipos Hartmann .....	412	pinza uterina Iowa .....	584
pinza para fijación Green .....	390	pinza para polipos Hartmann-Hoffmann .....	412	pinza uterina Jacobs .....	583
pinza para fijación Kirby-Arthur .....	385	pinza para polipos Hartmann-Wulstein .....	412	pinza uterina Jarcho .....	583
pinza para fijación Lester .....	389	pinza para polipos laringeos Jurasz .....	471	pinza uterina Museux .....	583
pinza para hemorroides McGivney .....	568	pinza para polipos Littauer .....	425	pinza uterina Pratt .....	584
pinza para hipofisis Adson .....	334	pinza para polipos Noyes .....	425	pinza uterina Schröder .....	584
pinza para histerectomía Heaney .....	126	pinza para polipos Struempel .....	412	pinza uterina Schroeder .....	583
pinza para histerectomía Heany-Ballentine .....	127	pinza para polipos uterinos Doyen .....	585	pinza uterina Schroeder (Pozzi) .....	582
pinza para histerectomía Holzbach .....	126	pinza para polipos uterinos Kelly .....	585	pinza uterina Skene .....	582
pinza para histerectomía Segond .....	125	pinza para polipos uterinos Noto .....	585	pinza uterina Staude-Moore .....	582
pinza para histerectomía Segond-Landau .....	125	pinza para quitar agrafes Collin .....	224	pinza uterina Teale .....	583
pinza para histerectomía Wertheim .....	124, 128	pinza para quitar agrafes Richter-Heath .....	224	pinza vascular .....	526
pinza para histerectomía Wertheim-Cullen .....	125	pinza para reducción .....	246	pinza vascular Cooley .....	520
pinza para hueso Bircher-Ganske .....	246	pinza para reposición Rowe .....	459	pinza vascular de uso múltiple Bainbridge .....	495
pinza para hueso Dingmann .....	246	pinza para secuestros .....	249	pinza vascular de uso múltiple Cooley .....	518-520
pinza para hueso Farabeuf .....	243	pinza para secuestros VAN Buren .....	249	pinza vascular de uso múltiple DeBaKey .....	
pinza para hueso Farabeuf-Lambotte .....	243	pinza para senoscopia .....	431	.....	495, 507, 508, 514, 515
pinza para hueso Fergusson .....	243	pinza para shunt carotídeo Javid .....	511	pinza vascular Neonatal .....	523
pinza para hueso Kern .....	244	pinza para sostener placas Lane .....	325	pinza vascular para neotales Castaneda .....	527
pinza para hueso Lambotte .....	244	pinza para sostener tornillos Lane .....	325	pinza vascular pediátrica Cooley .....	522
pinza para hueso Lane .....	244	pinza para sutura Castroviejo .....	392	pinza vascular pediátrica DeBaKey .....	516, 517
pinza para hueso Langenbeck .....	243	pinza para sutura Mod. Bonn .....	386	pinzas atraumáticas DeBaKey .....	98, 99
pinza para hueso Lewin .....	246	pinza para sutura Mod. Tübingen .....	386	pinzas de disección .....	81, 81/1
pinza para hueso Patella .....	248	pinza para sutura Moorfield .....	392	pinzas para espinas .....	91, 92
pinza para hueso REDA .....	246	pinza para sutura St. Martin .....	392	pinzas Ultra-Ligera .....	95
pinza para hueso Reill .....	248	pinza para tabique nasal Graig .....	426	Piper forceps obstétrico .....	604
pinza para hueso Semb .....	243	pinza para tabique nasal Middleton-Jansen .....	430	Pistola lavadora .....	626
pinza para hueso Ulrich .....	248	pinza para tapones .....	135	placa para extender la piel .....	49
pinza para hueso Verbrugge .....	245	pinza para tapones Jackson .....	471	placa para párpado Jaeger .....	371
pinza para huesos autocentrantes .....	245	pinza para tapones Ulrich .....	135	plato para tabletas .....	621
pinza para huesos Feldheim .....	249	pinza para tejido Collin .....	539	Plester cuchillo .....	418
pinza para huesos Lambert-Lowman .....	249	pinza para tejido Duval .....	539	Plester separador .....	171
pinza para huesos Lowman .....	249	pinza para tejido Williams .....	539	Plester tubo de aspiración .....	338
pinza para huesos Lowman-Hoglund .....	249	pinza para tendones Larsen .....	292	polipotomía Krause .....	433/2



polipotomo Krause-Voss.....	433/2	Pratt especulo rectal .....	559	Reill pinza para hueso .....	248
polipotomo Wilde .....	433/2	Pratt pinza hemostatica .....	110	Reiner cuchillo para vendaje enyesado .....	233
Politzer aguja para paracentesis .....	408	Pratt pinza uterina .....	584	Reiner jeringa auricular.....	406
Politzer cuchillo auricular .....	408	Pratt sonda para fistula.....	563	Resano pinza intestinal .....	542
Politzer especulo auricular .....	399	PRECISA esfigmomanometro .....	9	RESANO tijera para capsula .....	53/2
Politzer oliva auricular .....	406	Presbyterian pinza cierra-tubo .....	129	retractor nasal Aufrecht .....	447
POOLE tubo de aspiracion .....	27	Price-Thomas pinza bronquial .....	490	retractor nasal Cottle .....	447, 447/1
porta aguja (micro) Barraquer .....	216, 217	Prince pinza muscular .....	386	retractor nasal Kilner .....	447/1
porta aguja (micro) Barraquer-Troutmann .....	216	PRINCE tijera para amigdalas .....	59	retractor nasal Masing.....	447
porta aguja (micro) Castroviejo-Standard .....	216	proctoscopio Bensaude .....	565	retractor nasal Masing-Neivert.....	447
porta aguja Adson .....	211	proctoscopio Fansler .....	564	retractor para amputacion Percy .....	296
porta aguja Arruga .....	214	proctoscopio Kelly .....	562, 563	Reverdin aguja.....	220
porta aguja Baby-Olsen-Hegar .....	212	proctoscopio Morgan .....	565	Reverdin separador abdominal .....	143/1
porta aguja Baumgartner .....	208	protector Arruga .....	378	REYNOLDS tijera para cirugia .....	54
porta aguja Boynton .....	214	Providence-Hospital pinza hemostatica .....	106	Reynolds tijera supercut .....	72
porta aguja Bozemann .....	211	punta de pinza Baracani .....	472	Ribbon espátula abdominal .....	143
porta aguja Brown .....	209	punta de pinza Bruenings .....	472	Ricard separador abdominal .....	191
porta aguja Castroviejo .....	215	punta de pinza Cordes .....	472	Richardson Grip separador .....	142
porta aguja Castroviejo-Micro.....	215	punta de pinza Fraenkel .....	472	Richardson separador .....	142
porta aguja Collier .....	208	punta de pinza Krause .....	472	Richardson-Eastman separador .....	142
porta aguja Crile .....	213	punta de pinza Lange .....	472	Richnau-Holmgren especulo auricular .....	400
porta aguja Crile-Murray .....	209	punta de pinza Scheimann .....	472	Richter-Heath pinza para quitar agrafes .....	224
porta aguja Crile-Wood .....	209	punta de pinza Schumacher .....	472	Rienhoff-Finochietto separador costal .....	486
porta aguja DeBakey.....	210	punta de pinza Seifert .....	472	Rigby separador .....	189/2
porta aguja DERF .....	208	Putti lima para huesos .....	294	RI-MINI estuche de diagnostico .....	17
porta aguja Finochietto .....	211	Q		Ring baja-lengua .....	455
porta aguja Gillies.....	212	Quervain periototomo.....	275	riñoneras .....	619
porta aguja Halsey .....	208	Quinby tijera para encias .....	67	Ritter-Halle dilatador para el seno .....	433
porta aguja Heaney .....	210	Quire elevador para cuerpos extraños.....	412	Robb disecador vascular .....	530
porta aguja Hoesel .....	213	Quising martillo .....	271	Robb espátula para la intima .....	530
porta aguja Jacobsen .....	215	quistotomo Becker .....	375	Roberts pinza hemostatica .....	117
porta aguja Johnson .....	211	quistotomo Graefe .....	375	Rochester-Carmalt pinza hemostatica .....	109
porta aguja Kalt .....	214	quita hojas .....	42	Rochester-Ochsner pinza hemostatica .....	108
porta aguja Kalt-Arruga.....	214	R		Rochester-Pean pinza hemostatica .....	108
porta aguja Kilner .....	212	Radolf pinza para arrancar uñas.....	297	Roeder pinza de campo .....	132
porta aguja Langenbeck .....	213	Ragnell separador .....	140	Roger elevador para el tabique nasal .....	437
porta aguja Lichtenberg .....	213	Ralk (Virtus) pinza para espinas .....	92	Roger pinza atraumatica .....	127
porta aguja Masson .....	210	Ralk perforador de mano .....	300	Rogge pinza para esterilizacion .....	227
porta aguja Mathieu .....	213	Ramplay porta esponjas .....	136	Rollet cinceal para extirpacion .....	374
porta aguja Mathieu-Olsen.....	212	Ramus separador para el ramo .....	461	Rollet gancho .....	375
porta aguja Mayo-Hegar .....	209	Randall cureta aspiradora para biopsia uterina .....	587	rompe hojas CASTROVIEJO .....	45
porta aguja Metzbaum .....	211	Randall pinza para calculos renales .....	535	rompe hojas REDA .....	45
porta aguja Microvascular.....	210	Raney grapa para cuero cabelludo .....	327	rompe hojas TROUTMAN-CHRIS .....	45
porta aguja Neivert .....	208	Raney pinza aplicadora .....	327	Rose separador .....	140
porta aguja Olsen-Hegar .....	212	raquioto .....	267	Rosen cuchillo .....	418
porta aguja Ryder .....	210	Ray cureta para hipofisis .....	334	Rosen gancho .....	419
porta aguja Sarot.....	211	Recamier curetas uterinas.....	597	Rosen tubo de aspiracion .....	338
porta aguja Stevens .....	214	REDA cucharilla cortante .....	256	Roser-Koenig abre-boca .....	454
porta aguja Stratte .....	212	REDA cuchillo de hoz .....	435	rotador Becher .....	379
porta aguja Wangenstein .....	210	REDA cuchillo para amputacion .....	44	Roux Baby separador .....	140
porta aguja Webster.....	208	REDA diapason .....	403	Roux mini separador .....	140
porta aguja Young Boomerang .....	220	REDA especulo nasal .....	423	Roux separador .....	139
porta esponjas Foerster .....	136	REDA Excenter tijera para vendaje.....	69/2	Rowe pinza para reposicion .....	459
porta esponjas Ramplay .....	136	REDA gancho .....	150	Rubin cinceal nasal .....	440
porta ligadura para tournique.....	528	REDA iman ocular .....	395	Rubin pinza para magullar tabique .....	428
porta pinza de traslado .....	615	REDA instrumento para vendaje enyesado .....	232	Rudd ligador para hemorroides .....	568
porta-algodon Farrell .....	203	REDA micro tijeras .....	77, 80	Rumel pinza hemostatica .....	117
porta-algodon Jobson-Horne .....	203	REDA perforador de mano .....	300	Rumel-belmont tournique .....	528
porta-algodon REDA .....	203	REDA pinza atraumatica .....	111	Ruskin pinza gubia .....	239
porta-algodon Tobold .....	203	REDA pinza autocentradora para sostener huesos .....	247	Ruskin-Liston pinza cortante para huesos .....	241
porta-algodon Uckermann .....	203	REDA pinza de reduction .....	247	Russel-Davis baja-lengua .....	458
porta-algon .....	203	REDA pinza depilatoria .....	395	Rydel-Seiffert diapason.....	404
porta-clamps De Martel-Wolfson .....	546	REDA pinza para hueso .....	246	Ryder porta aguja.....	210
portador de luz fria KLEINSASSER .....	36	REDA porta-algodon .....	203	S	
portador de luz HOLINGER .....	37	REDA rompe hojas .....	45	Saalfeld saca comedones .....	608
portador de luz JACKSON .....	37	REDA sierra para abrir anillos .....	297	saca comedones Saalfeld .....	608
POTTS DE MARTEL tijera vascular.....	59	REDA sonda conductora .....	221	saca comedones Schamberg .....	608
Potts pinza para anastomosis.....	493	REDON aguja de guia .....	207	saca comedones Unna .....	608
Potts pinza para coartacion .....	492	Rees tijera face lift.....	73	saca comedones Walton .....	608
Potts-Smith pinza de diseccion .....	81, 81/1	regla .....	25	Sachs elevador para duramadre .....	332
Potts-Smith tijera vascular .....	61	Reichert depresor para epiglotis.....	471	Sachs gancho para nervio .....	329
Pozzi (Schroeder) pinza uterina.....	582			Saenger pinza para aborto .....	606
Pratt dilatador uterino .....	580				





salpingografo Schultze.....	596	separador abdominal Baby Gosset.....	181	separador intra oral L&M.....	463/4
SANVERNERO tijera para cirugia.....	54	separador abdominal Back holder.....	192, 193, 194, 195	separador Israel.....	162
Sarot pinza hemostatica.....	118	separador abdominal Balfour.....	182, 183	separador Jackson-Burrows.....	189/2
Sarot porta aguja.....	211	separador abdominal Balfour Baby.....	182, 183	separador Jansen.....	168
Satinsky pinza para vasos.....	491	separador abdominal Balfour-us.....	184	separador Kelly.....	142, 164
Satinsky tijera para vasija.....	65/2	separador abdominal Charnley.....	289	separador Kelly Grip.....	142
Sato cuchillo corneal.....	373	separador abdominal Collin.....	190	separador KOCHER.....	155
Satterlee sierra para amputacion.....	296	separador abdominal Collin Loktite.....	191	separador Kocher.....	159, 160, 163
Sauerbruch costotomo.....	481	separador abdominal Denis-Browne.....	185	separador Kocher-Langenbeck.....	159
Sauerbruch pinza gubia.....	240	separador abdominal Doyen.....	189/1	separador Koerte.....	162
Sauerbruch pinza para desechos.....	227	separador abdominal Frazier.....	181	separador König.....	153
Sauerbruch separador.....	164, 166	separador abdominal Gosset.....	181	separador Körte.....	143/1
Sauerbruch-Frey costotomo.....	481	separador abdominal Kirschner.....	185, 187, 187/1	separador Lahey.....	157
Sawtell pinza para coger las amigdalas.....	467	separador abdominal Kümmel.....	143/2	separador Langenbeck.....	158, 159
Sawyer especulo rectal.....	560	separador abdominal O'Sullivan-O'Connor.....	181	separador Langenbeck-Green.....	153
SAVRE elevador.....	281	separador abdominal Reverdin.....	143/1	separador Little.....	157
Scaglietti pinza gubia.....	240	separador abdominal Ricard.....	191	separador Luer.....	140
Scalp-Contour separador.....	169	separador Adson.....	172, 173, 174	separador mamarío Breast.....	198
Scapula (Davidson) separador.....	166	separador Alm.....	168	separador manibular Obwegeser.....	461
Schaedel pinza de campo.....	132	separador Anderson.....	198	separador Martin.....	175/1
Schamberg saca comedones.....	608	separador Anderson Adson.....	172	separador Mathieu.....	141
Schede cucharilla cortante.....	251	separador Aufranc-Cobra.....	289	separador Mayo-Adams.....	171
Scheie cuchillo para goniotomia.....	373	separador Beckmann.....	176	separador Mayo-Collins.....	141
Scheinmann punta de pinza.....	472	separador BECKMANN-ADSON.....	175	separador Meyerding.....	157, 177, 180
Scherbak especulo vaginal.....	575	separador Beckmann-Eaton.....	176	separador Middeldorf.....	160
Schimmelbusch tambores para esterilizacion.....	621	separador Brunner.....	167	separador Mikulicz.....	163
SCHINK dermatomo.....	49	separador Caspar.....	179, 180	separador Mollison.....	171
Schioetz tonometro.....	394/2	separador Cloward.....	178	separador Morris.....	164
Schlesinger pinza cortante para laminectomia.....	342	separador Collin.....	139	separador Murphy.....	156
Schmeden pinza nasal.....	427	separador Collin-Hartmann.....	141	separador nasal Converse.....	448
Schmid canula para lavador vascular.....	338	separador Cooley.....	148	separador Norfolk / Norwich.....	172
Schmieden sonda conductora.....	221	separador Coronal Blow Lift.....	198	separador obstetrico Sellheim.....	607
Schmieden-Dick aguja para ligadura.....	219	separador Coryllos (Thorax).....	166	separador Ollier.....	162
Schmieden-Payr sonda conductora.....	221	separador costal Cooley.....	485, 487	separador para cirugia plastica Ferriera.....	197
Schmieden-Taylor tijera duramadre.....	65/1	separador costal De Boer.....	486	separador para cirugia plastica Tebbetts.....	197
Schmidt pinza para coger las amigdalas.....	467	separador costal Finochietto.....	482, 484	separador para cuerpo vertebral Cloward.....	339
Schoenborn separador para la glandula tiroidea.....	479	separador costal Finochietto-Burford.....	483	separador para cuerpo vertebral Inge.....	339
Schröder curetas uterinas.....	595	separador costal Haight.....	487	separador para el borde anterior Hargis.....	463
Schröder pinza uterina.....	584	separador costal Morse.....	484	separador para el cuerpo mandibular Hargis.....	463/6
Schroeder (Pozzi) pinza uterina.....	582	separador costal Morse-Favaloro.....	484	separador para el ramo Ramus.....	461
Schroeder pinza uterina.....	583	separador costal Rienhoff-Finochietto.....	486	separador para el ramo Spina-Nasalis.....	461
Schubert pinza para biopsia.....	588	separador costal Tuffier.....	487	separador para la glandula tiroidea Schoenborn.....	479
Schuhknecht cuchillo.....	418	separador Crile.....	140	separador para la raiz de nervios D'Errico.....	329/2
Schultze salpingografo.....	596	separador cuello vejiga Millin.....	553	separador para la raiz de nervios Hess.....	329/1
Schulze-Bergmann especulo rectal.....	560	separador Cushing.....	151, 152, 153	separador para la raiz de nervios Holsher.....	329/1
Schumacher pinza para biopsia.....	588, 589	separador Darling.....	178	separador para la raiz de nervios Love.....	329/2, 330
Schumacher punta de pinza.....	472	separador Davidson (Scapula).....	166	separador para la raiz de nervios Scoville.....	329/1, 330
Schumacher tijera para cordon umbilical.....	64	separador de mobilizacion Tessier.....	463/3	separador para labios y mejillas.....	453
Schumacher tijera para esternon.....	481	separador de pelvis St. Marks.....	165	separador para labios y mejillas Sternberg.....	453
Schweigger pinza capsular.....	391	separador de sistema Leyla.....	368-368/4	separador para laminectomia Cherry.....	488
Scoville cucharilla cortante.....	253	separador DEEVER.....	145, 146	separador para laminectomia Scoville.....	196
Scoville separador para la raiz de nervios.....	329/1, 330	separador DEEVER GRIP.....	146	separador para laminectomia Scoville-Haverfield.....	196
Scoville separador para laminectomia.....	196	separador DeBakey.....	189/1	separador para menisco Smillie.....	291
Scoville-Haverfield separador para laminectomia.....	196	separador Desmarres.....	151	separador para paladar Nager.....	465
Scudder pinza intestinal.....	541	separador Doyen.....	163	separador para partes blandas Obwegeser.....	460
Sebileau periostotomo.....	275	separador Doyen-Stille.....	167	separador para pilar Hofer.....	465
Sedillot periostotomo.....	274, 275	separador espinal Taylor.....	291	separador para piloro Benson.....	544
Segond bisturi para fibroma.....	594	separador Farabeuf.....	139	separador para rodilla Blount.....	289
Segond pinza para histerectomia.....	125	separador Finsen.....	168	separador para tejido cervical Cloward.....	339
Segond-Landau pinza para histerectomia.....	125	separador Freeman.....	198	separador para tendones Bunell.....	292
Seifert punta de pinza.....	472	separador Fritsch.....	163	separador para uvula Love.....	465
Seldin periostotomo.....	277	separador Gil-Vernet.....	152	separador para yesos Beeson.....	232
Sellheim separador obstetrico.....	607	separador Goelet.....	141	separador para yesos Haglund-Stille.....	232
Semb periostotomo.....	278	separador Green.....	160	separador para yesos Henning.....	232
Semb pinza bronquial.....	491	separador Harrington.....	147	separador Parker.....	139
Semb pinza cortante para huesos.....	242	separador Harrington-Pemberton.....	147	separador perineal Gelpij.....	189/1, 189/2
Semb pinza gubia.....	240	separador Heaney.....	164	separador Perkins.....	168
Semb pinza para hueso.....	243	separador Henley.....	170	separador Plester.....	171
Semken pinza de diseccion.....	86	separador Hibbs.....	164	separador prostatico Young.....	550
Semm especulo vaginal.....	571	separador Holzheimer.....	168	separador Ragnell.....	140
Senn-Green separador.....	153	separador Hösel.....	167	separador rectal Smith-Buie.....	561
Senn-Miller separador.....	143	separador intestinal Leriche.....	143/2	separador Richardson.....	142
sensimetro WARTENBERG.....	25	separador intra oral.....	463/1, 463/4	separador Richardson Grip.....	142

separador Richardson-Eastman .....	142	Sinsky gancho .....	376	Stevenson blerarostato .....	371
separador Rigby .....	189/2	Sinus (Lister) pinza porta esponja .....	137	Stieglitz pinza para espinas .....	92
separador Rose .....	140	Sinus sonda para sinoscopia .....	438	Stille (Leksell) pinza gubia .....	240
separador Roux .....	139	sistema de brazo .....	188, 189	Stille cincel .....	260
separador Roux Baby .....	140	Skene pinza uterina .....	582	Stille cizalla para yesos .....	229
separador Roux mini .....	140	Sluder-Ballenger amigdalotomo .....	470	Stille costotomo .....	480
separador sagital Smith .....	463/5	Smellie gancho obstetrico .....	605	Stille gubia .....	260
separador Sauerbruch .....	164, 166	Smellie perforacraneo .....	607	Stille osteotomo .....	260
separador Scalp-Contour .....	169	Smillie meniscotomo .....	292	Stille perforador de mano .....	298
separador Senn-Green .....	153	Smillie separador para menisco .....	291	Stille pinza de diseccion .....	81, 81/1
separador Senn-Miller .....	143	Smith blefarostato .....	370	Stille pinza hemostatica .....	122
separador Simon .....	164	Smith separador sagital .....	463/5	Stille-Barraya pinza de diseccion .....	88
separador Strandell-Stille .....	157	Smith Us Army tijera para gaza .....	69/1	Stille-Horsley pinza cortante para huesos .....	242
separador toracico Mercedes .....	489	Smith-Buie separador rectal .....	561	Stille-Liston pinza cortante para huesos .....	242
separador traqueal Bose .....	476	Smith-Petersen cincel .....	261	Stille-Luer pinza gubia .....	239
separador traqueal Jackson .....	476	Smith-Petersen gubia .....	261	Stille-Ruskin pinza gubia .....	239
separador Travers .....	172	Smith-Petersen pinza gubia .....	238	Stille-Sherman perforador de mano .....	298
separador Tuffier .....	147	Smithwick gancho para nervio .....	329	Stockmann pinza para el pene .....	553/1
separador US ARMY / Parker-Langenbeck .....	141	Smithwick pinza aplicadora .....	326	Stone pinza para cerrar clamps .....	545
separador vesical Judd-Masson .....	552	Snellen asa .....	378	Stone-Watt manguito de cierre .....	545
separador vesical Legueu .....	553	Snellen pinza muscular .....	393	Stone-Watt pinza intestinal .....	545
separador vesical Millin .....	552	Somer pinza para el utero .....	585	STRABISMUS tijera .....	58
separador vesical Thomson-Walker .....	552	sonda abotonada Jacobson .....	335	Strandell-Stille separador .....	157
separador Volkmann .....	153, 154, 156	sonda acanalada .....	199	Strassburger pinza de diseccion .....	89
separador Weitlaner .....	169	sonda acanalada Brodie .....	199	Stratte porta aguja .....	212
separador Weitlaner-Wullstein .....	169	sonda auricular Stacke .....	199	Strauss pinza para el pene .....	553/1
separador Wullstein .....	171	sonda conductora Brunner .....	221	Struempel pinza para polipos .....	412
separador Yancoskie .....	198	sonda conductora Kirschner .....	221	Strully tijera para neurocirugia .....	65
separador Zenker .....	161	sonda conductora Koenig .....	221	Struycken pinza nasal .....	427
Serpentine Grasper pinza para biopsia .....	593	sonda conductora Payr .....	221	Subramanian pinza para la aorta .....	521
serra-fina Dieffenbach .....	104	sonda conductora REDA .....	221	Subramanian-Miniature pinza para la aorta .....	521
serra-fina Johns-Hopkins .....	104	sonda conductora Schmieden .....	221	Supercut tijera Baby Metzenbaum .....	71
Seutin tijera para vendaje .....	69/2	sonda conductora Schmieden-Payr .....	221	Supercut tijera Iris .....	72
Sexton cuchillo auricular .....	408	sonda conductora Vienna .....	221	supercut tijera Kilner/Ragnell .....	72
Shambaugh gancho .....	419	sonda Fish .....	199	Supercut tijera La Grange .....	72
Shapleigh asa .....	410	sonda Harms .....	381	supercut tijera Lister .....	72
Shea tijera auricular micro .....	413	sonda lacrimal Bowman .....	381	supercut tijera Mayo .....	71
Sheehan cincel nasal .....	441	sonda lacrimal Worst .....	381	Supercut tijera Mayo-Stille .....	71
Sheets canula .....	394/2	sonda Nelaton .....	199	Supercut tijera Metzenbaum .....	71
Siebenmann dilatador para el seno .....	433/1	sonda para bocio Kocher .....	479	supercut tijera Reynolds .....	72
Siebold tijera ginecologica .....	62	sonda para calculos biliares Mayo .....	534	supercut tijera Stevens .....	72
Siegle especulo auricular .....	402	sonda para fistula Lockhart-Mummery .....	200	supercut tijera wagner .....	72
Sierra hilo Olivecrona .....	332	sonda para fistula Pratt .....	563	Supercut tijeras .....	71, 72
sierra nasal Joseph .....	446	sonda para mesurar House .....	420	Sweet pinza aplicadora .....	326
sierra oscilante con aspiracion .....	231	sonda para sinoscopia Sinus .....	438	Systrunk tijera para cirugia .....	66
sierra oscilante para vendajes enyesados .....	230	soporte de esterilizacion para alambres de Kirschner .....	305		
sierra para abrir anillos REDA .....	297	soporte de pecho Negus .....	459	<b>T</b>	
sierra para abrir anillos Walton .....	297	soporte pectoral KLEINSASSER .....	36	Tabb cuchillo .....	418
sierra para amputacion Bier .....	296	Spencer tijera para ligadura .....	66	Takahashi pinza nasal .....	427
sierra para amputacion Charriere .....	296	Spencer-Wells pinza hemostatica .....	109	taladros .....	302
sierra para amputacion Langenbeck .....	296	Spinal cucharilla cortante .....	253	tambores para esterilizacion Schimmelbusch .....	621
sierra para amputacion Satterlee .....	296	Spina-Nasalis separador para el ramo .....	461	tamponeador Luniatshchek .....	465
sierra para autopsia .....	231/1, 231/2, 231/3	Spratt cucharilla cortante .....	251	Tarnier cranioclasto .....	607
sierra para vendajes enyesados Engel .....	229	Spurling pinza cortante para laminectomia .....	340	Tarnier forceps obstetrico .....	604
silleta .....	621	St. Marks separador de pelvis .....	165	tarros .....	620
Silver cincel nasal .....	442	St. Martin pinza para sutura .....	392	TAYLOR martillo de percusion .....	24
SILVER dermatomo .....	50	St. Clair-Thomson cuchillo para vegetaciones adenoides .....	450	Taylor pinza de diseccion .....	87
Simcoe canula .....	394/2	Stacke sonda auricular .....	199	Taylor separador espinal .....	291
Simon cucharilla uterina .....	594	Stamm pinza cortante para huesos .....	241	Teale pinza uterina .....	583
Simon separador .....	164	Standard (Nelson) trocar abdominal .....	204	Tebbetts separador para cirugia plastica .....	197
Simplex cierra-tubos .....	624	Standard estuche para sutura .....	226	Thomas-Gaylor pinza para biopsia .....	588
Simpson forceps obstetrico .....	602	Standard pinza de diseccion .....	81, 81/1	Thoms-Allis pinza intestinal .....	538
Simpson-Braun forceps obstetrico .....	602	STANDARD tijera para cirugia .....	51	Thomson-Walker separador vesical .....	552
Simpson-Luikart forceps obstetrico .....	603	Staude-Moore pinza uterina .....	582	Thorax (Coryllos) separador .....	166
Sims curetas uterinas .....	597	Steinmann alambre .....	307, 308	Thorek tijera vesicula biliar .....	65/2
Sims depresor uterino .....	586	Steinmann pinza de agarre para tendones .....	292	Thudichum especulo nasal .....	421
Sims dilatador uterino .....	581	Stelbrink pinza gubia .....	234	Tieck-Halle especulo nasal .....	423
Sims especulo rectal .....	559	Sternberg separador para labios y mejillas .....	453		
Sims especulo vaginal .....	573	Stevens gancho para cristalino .....	375		
Sims histerometro .....	586	Stevens pinza para iris .....	383		
Sims tijera ginecologica .....	62	Stevens porta aguja .....	214		
Sims-Maier pinza porta-esponja .....	134	STEVENS tijera para tenotomia .....	58		
Singley pinza de diseccion .....	88	Stevens tijera supercut .....	72		



tijera auricular micro Bellucci.....	413, 417
tijera auricular micro Shea.....	413
tijera corneal AEBLI.....	58
tijera cuticular.....	610
tijera de diseccion DEEVER.....	52
tijera de diseccion JORGENSEN.....	53
tijera de diseccion LEXER.....	53
tijera de diseccion LEXER BABY.....	53
tijera de diseccion MAYO.....	52
tijera de diseccion MAYO-NOBLE.....	52
tijera de diseccion MAYO-STILLE.....	52
tijera de diseccion METZENBAUM.....	53/1
tijera de diseccion WELLER.....	53/2
tijera de incision.....	52
tijera DeBakey.....	60
tijera duramadre Schmieden-Taylor.....	65/1
tijera ENUCLEATION.....	58
tijera face lift Freeman.....	73
tijera face lift Gorney.....	73
tijera face lift Kaye.....	73
tijera face lift Peck Joseph.....	73
tijera face lift Rees.....	73
tijera ginecologica Doyen.....	63
tijera ginecologica Dubois.....	63
tijera ginecologica Siebold.....	62
tijera ginecologica SIMS.....	62
tijera ginecologica Wertheim.....	63
tijera Martin-Cartilage.....	65/1
tijera nasal.....	428, 429
tijera nasal COTTLE.....	59
tijera nasal FOMON.....	58
tijera nasal HEYMANN.....	58
tijera nasal Watson-Williams.....	428
tijera Northbent.....	66
tijera para alambre y laminas Universal.....	67
tijera para amigdalas.....	59
tijera para amigdalas BOETTCHER.....	59
tijera para amigdalas DEAN.....	59
tijera para amigdalas GOOD.....	59
tijera para capsula RESANO.....	53/2
tijera para cartilago McIndoe.....	65/1
tijera para cirugia COTTLE.....	56
tijera para cirugia GRAEFFE.....	56
tijera para cirugia IRIS.....	54
tijera para cirugia JOSEPH.....	54
tijera para cirugia KILNER.....	54
tijera para cirugia LITTLER.....	55
tijera para cirugia METZENBAUM.....	54
tijera para cirugia REYNOLDS.....	54
tijera para cirugia SANVERNERO.....	54
tijera para cirugia STANDARD.....	51
tijera para cirugia Systrunk.....	66
tijera para cirugia Waldmann.....	64
tijera para cordon umbilical Busch.....	64
tijera para cordon umbilical Mod. USA.....	64
tijera para cordon umbilical Schuhmacher.....	64
tijera para corneales Castroviejo.....	79
tijera para coronas Beebe.....	68
tijera para encias Goldman-Fox.....	67
tijera para encias La Grange.....	69
tijera para encias Locklin.....	69
tijera para encias Quinby.....	67
tijera para enterotomo.....	66
tijera para episiotomia Braun-Stadler.....	64
tijera para esternon Schumacher.....	481
tijera para gaza Smith Us Army.....	69/1
tijera para intestino Fergusson.....	66
tijera para iridectomia Castroviejo.....	79
tijera para iridectomia Vannas.....	79
tijera para iris Noyes.....	75
tijera para iris Wecker.....	75
tijera para ligadura Heath.....	66
tijera para ligadura Littauer.....	66

tijera para ligadura Spencer.....	66
tijera para neurocirugia.....	65
tijera para neurocirugia Strully.....	65
tijera para oftalmologia.....	57
tijera para oftalmologia.....	75, 79
tijera para oftalmologia Barraquer Colibri.....	75
tijera para oftalmologia GRADLE.....	57
tijera para parametrium.....	63
tijera para preparacion.....	65
tijera para rinoplastia Fomon.....	65/1
tijera para septo Killian.....	471
tijera para tendon Westcott.....	75
tijera para tenotomia STEVENS.....	58
tijera para uñas.....	609, 614
tijera para vasija Klinkenbergh-Loth.....	65/2
tijera para vendaje.....	69/1, 69/2, 70
tijera para vendaje Bergmann.....	69/1
tijera para vendaje Bruns.....	70
tijera para vendaje Esmarch.....	69/2
tijera para vendaje Knowles.....	70
tijera para vendaje Lister.....	69/1
tijera para vendaje Lorenz.....	70
tijera para vendaje REDA Excenter.....	69/2
tijera para vendaje Seutin.....	69/2
tijera para vendaje Universal.....	70
tijera para vesicula biliar Thorek.....	65/2
tijera pulmonares Crafoord.....	65/2
tijera STRABISMUS.....	58
tijera supercut Baby Metzenbaum.....	71
tijera supercut Iris.....	72
tijera supercut Kilner/Ragnell.....	72
tijera supercut La Grange.....	72
tijera supercut Lister.....	72
tijera supercut Mayo.....	71
tijera supercut Mayo-Stille.....	71
tijera supercut Metzenbaum.....	71
tijera supercut Reynolds.....	72
tijera supercut Stevens.....	72
tijera supercut Wagner.....	72
tijera Toennis-Adson.....	65
tijera vascular DeBakey.....	61
tijera vascular DIETRICH.....	60
tijera vascular Favalora.....	61
tijera vascular Kelly.....	61
tijera vascular POTTS DE MARTEL.....	59
tijera vascular Potts-Smith.....	61
tijera vasija Satinsky.....	65/2
tijera Wagner.....	67
tijeras para cirugia KNAPP.....	55
tijeras Supercut.....	71, 72
tijeras vasculares.....	59
Tilley pinza auricular.....	411
tirabuzon para fibroma Doyen.....	594
Tischler-Down pinza para biopsia.....	591
Tischler-Kevorkian pinza para biopsia.....	592
Tischler-Morgan pinza para biopsia.....	590, 591
Tischler-Up pinza para biopsia.....	591
Tobold baja-lengua.....	453
Tobold porta-algodon.....	203
Toennis elevador para duramadre.....	332
Toennis pinza hemostatica.....	117
Toennis-Adson tijera.....	65
Tohoku pinza de campo.....	132
tonometro Schioetz.....	394/2
Took cuchillo corneal.....	373
torniquete pneumatico.....	295
tourneque Rumel-Belmont.....	528
TOWNLEY calibre.....	26
Townsend pinza para biopsia.....	591
Toynbee especulo auricular.....	399
tractor Barton.....	603
tractor Bill.....	604
tractor Luikart-Bill.....	604

transformador para mango de pila para laringoscopio.....	34
Travers separador.....	172
Trelat especulo vaginal.....	571
trepano Keyes.....	608
trocar abdominal Standard (Nelson).....	204
trocar Douglas.....	204
trocar Nelson.....	205
trocar Ochsner.....	205
trocar para seno maxilar Coakley.....	204
trocar para seno maxilar Lichtwitz.....	204
trocar para seno maxilar Pierce.....	204
trocar para sinoscopia.....	205
trocar Universal.....	204
Troeltsch (Wilde) pinza auricular.....	410
Troeltsch pinza nasal.....	424
TROEMNER martillo de percusion.....	24
Trousseau-Baby dilatador traqueal.....	476
Trotman (Colibri) pinza para iris.....	384
Trotman pinza para iris.....	389
TROUTMAN-CHRIS.....	45
Tubbs dilatador de aorta.....	528
Tübingen pinza para ligadura.....	392
Tübingen pinza para sutura.....	386
tubo de aspiracion.....	337, 337/1, 337/2, 338
tubo de aspiracion Adson.....	337
tubo de aspiracion ANDREW-PYNCHON.....	28
tubo de aspiracion BABY-YANKAUER.....	27
tubo de aspiracion COOLEY.....	28
tubo de aspiracion Fergusson.....	337
tubo de aspiracion Frazier/Fergusson.....	337
tubo de aspiracion House.....	337/2
tubo de aspiracion Plester.....	338
tubo de aspiracion POOLE.....	27
tubo de aspiracion Rosen.....	338
tubo de aspiracion Yasargil.....	337/1
tubo de aspiracion Zöllner.....	337/1
tubo de extension Bruenings.....	472
tubos de aspiracion YANKAUER.....	27
Tuffier pinza hemostatica.....	110
Tuffier separador.....	147
Tuffier separador costal.....	487
Turnbull alicate para cortar uñas.....	609
Turrel pinza para biopsia rectal.....	567
Tyding amigdalotomo.....	469
Tyding pinza para coger amigdalas.....	468

### U

U.S. Kirschner estribo para extension.....	312
Uckermann porta-algodon.....	203
Ulrich pinza para hueso.....	248
Ulrich pinza para tapones.....	135
UNI I estuche de diagnostico / otoscopio.....	13
UNI II estuche de diagnostico/ oftalmoscopio May.....	14
UNI III estuche de diagnostico.....	15
Universal pinza para esterilizacion.....	227
Universal tijera para alambre y laminas.....	67
Universal tijera para vendaje.....	70
Universal trocar.....	204
Unna saca comedones.....	608
uretrotomo Otis.....	553
US Army / Parker-Langenbeck separador.....	141
USA Mod. tijera para cordon umbilical.....	64
USA pinza de diseccion.....	81, 81/1

### V

V. Petz aparato para suturar estomago y intestinos.....	549
vaina para tornillos.....	324
Valleix histerometro.....	586
Van Buren buja dilatadora.....	554
Van Buren pinza para secuestros.....	249
van Doren pinza para biopsia.....	588
Vannas tijera para iridectomia.....	79
Vardy instrumento para varices.....	202



vasos graduados .....	621	Williger periostotomo .....	276
vendaje de compresion Esmarch .....	296	Winter pinza para aborto .....	606
Verbrugge pinza para hueso .....	245	Wittner pinza para biopsia .....	589
Verbrugge-Müller elevador .....	286/2	Wolff pinza para arrancar vendaje enyesado .....	233
Verres aguja para neumoperitoneo .....	206	Woodson elevador para duramadre .....	333
Vienna especulo nasal .....	421	Worst sonda lacrimal .....	381
Vienna sonda conductora .....	221	Wrigley forceps obstetrico .....	602
VIRCHOW cuchillo para autopsia .....	48	Wullstein cuchillo .....	418
VIRCHOW cuchillo para cerebro .....	48	Wullstein mango de aspiracion .....	338
Virtus (RALK) pinza para espinas .....	92	Wullstein pinza auricular micro .....	416
Volkman cucharella cortante .....	251, 257	Wullstein separador .....	171
Volkman separador .....	153, 154, 156	Wylie dilatador uterino .....	581
Voitolini especulo nasal .....	421		
Vu-More especula vaginal .....	569	<b>Y</b>	
		Yancoskie separador .....	198
<b>W</b>		Yankauer elevador para amigdalas .....	465
Wachenfeldt pinza para aplicar agrafes .....	224	YANKAUER tubo de aspiracion .....	27
Wadsworth-Todd cauterio .....	378	Yasargil clips para aneurisma .....	345-356
Wagener gancho abotonado .....	409	Yasargil gancho para galea .....	330
Wagener-Mosher canula para traqueotomia .....	477	Yasargil pinza para tumores .....	97
Wagner pinza cortante para laminectomia .....	343	Yasargil tubo de aspiracion .....	337/1
Wagner tijera .....	67	Yeoman cierra-nudo rectal .....	566
Wagner tijera supercut .....	72	Yeoman pinza para biopsia rectal .....	566, 567
Waldmann tijera para cirugía .....	64	Young Boomerang aguja .....	220
Wallich cucharella para aborto .....	607	Young Boomerang porta aguja .....	220
Walsham pinza para enderezar el tabique nasal .....	449	Young pinza de agarre para prostata .....	550
Walton gubia para cuerpos extraños .....	374	Young pinza tira-lengua .....	453
Walton saca comedones .....	608	Young separador prostatico .....	550
Walton sierra para abrir anillos .....	297		
Wangensteen pinza de diseccion .....	89	<b>Z</b>	
Wangensteen porta aguja .....	210	Zaufal elevador auricular .....	409
WARTENBERG sensimetro .....	25	Zaufal-Jansen elevador auricular .....	409
WATSON dermatomo .....	50	Zaufal-Jansen pinza gubia .....	238
Watson-Cheyne disecador .....	199	Zenker pinza hemostatica .....	118
Watson-Cheyne elevador .....	283	Zenker separador .....	161
Watson-Williams pinza nasal .....	428	Ziegler blefarostato .....	371
Waugh pinza de diseccion .....	83	Ziegler cuchillo para discision .....	373
Weber asa .....	378	Ziegler cuchillo para iris .....	372
Weber pinza para la aorta .....	501	Ziegler dilatador lacrimal .....	381
Webster porta aguja .....	208	ZIEGLER espejo frontal .....	21
Wecker espátula para iris .....	378	Zielke gubia .....	264
Wecker tijera para iris .....	75	Zöllner tubo de aspiracion .....	337/1
Week blefarostato .....	370		
Weil-Blakesley pinza nasal .....	426		
Weitlaner separador .....	169		
Weitlaner-Wullstein separador .....	169		
WELLER tijera de diseccion .....	53/2		
Wells espátula para enucleacion .....	378		
Wertheim pinza para histerectomia .....	124, 128		
Wertheim tijera ginecologica .....	63		
Wertheim-Cullen pinza para histerectomia .....	125		
West cincel nasal .....	442/1		
Westcott tijera para tendon .....	75		
Westmacott pinza nasal .....	424		
Wheeler cuchillo para discision .....	373		
Wheeler espátula para ciclodialisis .....	379		
White pinza para coger amigdalas .....	467		
Wieder baja-lengua .....	452		
Wiener escofina nasal .....	443		
Wiener gancho para iris .....	375		
Wigmore cuchillo para vendajes enyesados .....	229		
Wikstroem pinza hemostatica .....	117		
Wilde (Troeltsch) pinza auricular .....	410		
Wilde cierra-nudo auricular .....	411		
Wilde polipotomo .....	433/2		
Wiider asa .....	378		
Wiider dilatador lacrimal .....	381		
Williams destornillador .....	323		
Willet Martel pinza hemostatica .....	110		
Williams blefarostato .....	370		
Williams pinza para tejido .....	539		
Williger cucharella cortante .....	255, 257		
Williger martillo .....	271		



ADENOTOMO LA FORCE.....	450	AGO, KOENIG.....	223	AXENFELD CURETTA DA CALAZIO.....	377
AGRAFES, MICHEL.....	224	AGO, REVERDIN.....	220	AYER PINZA PER CALAZIO.....	393
ABBASSALINGUA.....	451	AGO, ROSEN.....	419	<b>B</b>	
ABBASSALINGUA DAVIS-BOYLE.....	455	AGO, YOUNG-BOOMERANG.....	220	BABCOCK PINZA PER AFFERRARE INTESTINI.....	539
ABBASSALINGUA DOUGHTY.....	458	ALAN-PARKS DIVARICATORE ANALE.....	561	BABINSKI MARTELLO DA PERCUSSIONE.....	24
ABBASSALINGUA RUSSEL-DAVIS.....	458	ALDERDYCE ELEVATORE.....	282	BABY BURKE PINZA PER BIOPSIA.....	590
ABBASSALINGUA, ANDREW.....	452	ALESATORE PER FEMORE, KUENTSCHER.....	321	BABY GOSSET DIVARICATORE ADDOMINALE.....	181
ABBASSALINGUA, BRUENINGS.....	451	ALESATORE PER L'APERTURA DEL MIDOLLO, KUENTSCHER.....	321	BABY METZENBAUM SUPERCUT FORBICI.....	71
ABBASSALINGUA, BUCHWALD.....	451	ALEXANDER PERIOTOTOMO.....	276	BABY TISCHLER PINZA PER BIOPSIA.....	592
ABBASSALINGUA, DINGMANN.....	456	ALEXANDER PINZA PER BIOPSIA.....	589	BABY WEBSTER PORT'AGHI.....	208
ABBASSALINGUA, FRENZEL.....	451	ALEXANDER SCALPELLO.....	259	BABY YANKAUER CANNULA D'ASPIRAZIONE.....	27
ABBASSALINGUA, HARTMANN.....	452	ALEXANDER SGORBIA.....	259	BABY-KOCHER PINZA INTESTINALE.....	540
ABBASSALINGUA, KILNER-DOUGHTY.....	456	ALGESIMETRO, WARTENBERG.....	25	BABY-OLSEN-HEGAR PORT'AGHI.....	212
ABBASSALINGUA, KROENIG.....	451	ALLEN PINZA PER L'APPENDICE.....	544	BABYPHON SFGIMOMANOMETRO.....	10
ABBASSALINGUA, MAYO.....	451	ALLIS PINZA PER AFFERRARE INTESTINI.....	537	BACINELLA.....	619, 620
ABBASSALINGUA, MORITZ-SCHMIDT.....	452	ALLIS-ADAIR PINZA PER AFFERRARE INTESTINI.....	537	BACINELLA PER PLACENTA.....	621
ABBASSALINGUA, TOBOLD.....	453	ALLIS-BABY PINZA PER AFFERARE INTESTINI.....	537	BACINELLA RENIFORMA.....	619
ABBASSALINGUA, WIEDER.....	452	ALLISON SPATOLA PER POLMONE.....	489	BACKHAUS PINZA FISSATELI.....	132
ABRAHAM COLTELLO PER TONSILLE.....	466	ALM DIVARICATORE.....	168	BAILEY APPROSSIMATORE COSTALE.....	489
ABRAHAM PINZA PER TONSILLE.....	468	ALVIS CURETTA PER CORPI ESTRANEI.....	374	BAILEY-BABY APPROSSIMATORE COSTALE.....	489
ACCESSORI DI FISSAZIONE, ANELLI E BARRE.....	195	AMNIOSCOPO.....	601	BAILEY-GIBBON APPROSSIMATORE COSTALE.....	489
ACCESSORI PER SEGA PER AUTOPSIA.....	231/2, 231/3	AMNIOTOMO, BEACHAM.....	586	BAINBRIDGE PINZA EMOSTATICA.....	119/2
ADATTATORE DI ILLUMINAZIONE.....	601	ANDERSON ADSON DIVARICATORE.....	172	BAINBRIDGE PINZA VASCOLARE.....	495
ADLERKREUTZ PINZA VASCOLARE.....	84	ANDREW ABBASSALINGUA.....	452	BAKES DILATATORE BILIARE.....	532
ADSON DIVARICATORE.....	173	ANDREW-PYNCHON TUBO D'ASPIRAZIONE.....	28	BALFOUR BABY DIVARICATORE ADDOMINALE.....	182
ADSON PINZA ANATOMICA.....	82	ANELLI DI GOMMA PER LEGATURA.....	568	BALFOUR DIVARICATORE ADDOMINALE.....	182
ADSON PINZA ANATOMICA.....	82	ANOSCOPO, HIRSCHMANN.....	562	BALFOUR DIVARICATORE ADDOMINALE.....	183
ADSON PINZA CHIRURGICA.....	82	ANSA AURICOLARE, BILLEAU.....	409	BALFOUR-US DIVARICATORE ADDOMINALE.....	184
ADSON BABY PINZA EMOSTATICA.....	113	ANSA AURICOLARE, SHAPLEIGH.....	410	BALL AND SOCKET PINZA FISSATELI.....	133
ADSON DIVARICATORE.....	172	ANSA PER CATERATTA, ARLT.....	378	BALLENGER COLTELLO PER SETTO.....	436
ADSON MICRO PINZA ANATOMICA.....	82	ANSA PER CATERATTA, SNELLEN.....	378	BALLENGER ELEVATORE PER SETTO.....	439
ADSON MICRO PINZA CHIRURGICA.....	82	ANSA PER CATERATTA, WEBER.....	378	BALLENGER PINZA PER TONSILLE.....	467
ADSON PERIOTOTOMO.....	282	ANSA PER CATERATTA, WILDER.....	378	BANE-HARTMANN PINZA SGORBIA.....	237
ADSON PINZA EMOSTATICA.....	112	ANSA PER POLIPI.....	411	BANGERTER SPATOLA PER CICLODIALISI.....	379
ADSON PINZA PER IPOFISI.....	334	ANSE PER TONSILLE.....	468	BARACANI INSERTO.....	472
ADSON PINZA SGORBIA.....	236	ANTRUM-CURETTA.....	435	BARANY ASSORDITORE.....	405
ADSON PORT'AGHI.....	211	ANVIL TRONCHESINA PER UNGHIE.....	613	BARBARA AGO.....	419
ADSON TENAGLIA PER OSSA.....	298	APPARECCHIATURA DI SUTURA GASTRO-INTESTINALE, V.PETZ.....	549	BARBARA UNCINO.....	419
ADSON TUBO D'ASPIRAZIONE.....	337	APPROSSIMATORE COSTALE, BAILEY.....	489	BARKAN COLTELLO PER GONIOTOMIA.....	373
ADSON UNCINO PER DURAMADRE.....	329	APPROSSIMATORE COSTALE, BAILEY-BABY.....	489	BARNHILL COLTELLO ADENOIDE.....	450
ADSON, DIVARICATORE.....	174	APPROSSIMATORE COSTALE, BAILEY-GIBBON.....	489	BARNHILL COLTELLO ADENOIDE.....	450
ADSON-BROWN PINZA CHIRURGICA.....	82	APPROSSIMATORE, BIEMER.....	366	BARON CANNULA D'ASPIRAZIONE.....	336
ADSON-DIVARICATORE.....	174	APPROSSIMATORE, BIEMER-MÜLLER.....	363	BARR SPECULO RETTALE.....	559
ADSON-BROWN PINZA CHIRURGICA.....	82	APRIBOCCA DI LEGNO MAUNDER.....	459	BARRAQUER (COLIBRI) PINZA PER IRIDE.....	384
AEBLI FORBICI PER OFTALMOLOGIA.....	58	APRIBOCCA, DAVIS-BOYLE.....	455	BARRAQUER BLEFAROSTATO.....	370
AGHI PER SUTURE.....	222, 223	APRIBOCCA, DAVIS-MEYER.....	457	BARRAQUER COLTELLO PER CHERATOPLASTICA.....	373
AGO PER BIOPSIA,FRANKLIN-SILVER.....	206	APRIBOCCA, DENHART,12CM.....	454	BARRAQUER FORBICI OCULISTICHE.....	75
AGO DI GUIDA, IOWA.....	206	APRIBOCCA, DINGMANN.....	456	BARRAQUER PINZA DA FISSAZIONE.....	390
AGO DI GUIDA, REDON.....	207	APRIBOCCA, HEISTER.....	454	BARRAQUER PINZA DEPILETORIA.....	395
AGO DI INTRODUZIONE, OBWEGESER.....	463	APRIBOCCA, JENNINGS.....	454	BARRAQUER PORT'AGHI.....	216, 217
AGO DI INTRODUZIONE, OBWEGESER.....	463/3	APRIBOCCA, KILNER-DOUGHTY.....	456	BARRAQUER-KATZIN PINZA PER IRIDE.....	384
AGO PASSAFILI, DEMEL.....	315	APRIBOCCA, MCIVOR.....	457	BARRAQUER-TROUTMAN PORT'AGHI.....	216
AGO PER CORPI ESTRANEI.....	374	APRIBOCCA, ROSEN-KOENIG 16CM.....	454	BARRET PINZA PER ABBASSARE IL COLLO	
AGO PER CORPI ESTRANEI, DAVIS.....	374	APRIBOCCA, DOYEN-JANSEN(MOLT).....	454	DELL'UTERO.....	582
AGO PER CORPI ESTRANEI, FRANCIS.....	374	ARCHER PINZA PER SCHEGGE.....	92	BARTON FORCIPE.....	603
AGO PER CORPI ESTRANEI, LA FORCE.....	374	ARCO PER ESTENSIONE, BOEHLER.....	312	BARTON TRATTORE.....	603
AGO PER CORPI ESTRANEI, LEVINSON.....	374	ARCO PER ESTENSIONE, KIRSCHNER.....	312	BAUMGARTNER PORT'AGHI.....	208
AGO PER DISCISIONE.....	374	ARCO PER ESTENSIONE, KIRSCHNER US.....	312	BEACHAM AMNIOTOMO.....	586
AGO PER DISCISIONE, BOWMAN.....	374	ARLT ANSA PER CATERATTA.....	378	BECHERT ROTATORE PER NUCLEO.....	379
AGO PER DISCISIONE, BOWMAN.....	374	ARRUGA BLEFAROSTATO.....	370	BECK PINZA PER ANASTOMOSI.....	520
AGO PER INSUFFLAZIONE, VERESS.....	206	ARRUGA CUCCHIAIO PER ASPORTAZIONE RETINALE.....	378	BECK PINZA VASCOLARI.....	516
AGO PER LEGATURE.....	218	ARRUGA PINZA CAPSULARE.....	391	BECKER CISTOTOMO.....	375
AGO PER LEGATURE SCHMIEDEN-DICK.....	219	ARRUGA PORT'AGHI.....	214	BECKMANN COLTELLO ADENOIDE.....	450
AGO PER LEGATURE, COOPER.....	219	ARRUGA UNCINO ESTRATTORE.....	375	BECKMANN DIVARICATORE.....	176
AGO PER LEGATURE, DESCHAMPS.....	218	ASCH PINZA PER LA PLASTICA NASALE.....	449	BECKMANN-ADSON DIVARICATORE.....	175
AGO PER LEGATURE, KRONECKER.....	219	ASSORDITORE, BARANY.....	405	BECKMANN-EATON DIVARICATORE.....	176
AGO PER LEGATURE, NELSON.....	219	AUFBRANC-COBRA DIVARICATORE.....	289	BEEBEE FORBICI PER CORONA.....	68
AGO PER PARACENTESI, LUCAE.....	408	AUFRICHT RASPA NASALE.....	443	BEER PINZA DEPILETORIA.....	395
AGO PER PARACENTESI, POLITZER.....	408	AUFRICHT UNCINO NASALE.....	447	BEESON DIVARICATORE PER GESSI.....	232
AGO PER TONSILLE.....	470	AUVARD SPECULO VAGINALE.....	576	BEESON DIVARICATORE PER GESSI.....	232
AGO PER TONSILLE, CLAUS.....	466			BELLUCCI MICRO FORBICI AURICOLARI.....	413
AGO PER TONSILLE, DUPUY-WEISS.....	466			BELLUCCI MICRO FORBICINE.....	417
AGO PER TONSILLE, NAGER.....	466			BENDA PER COMPRESIONE ESMARCH.....	297
AGO POST MORTEM.....	268				
AGO, BARBARA.....	419				
AGO, KEITH.....	223				



BENDER MODELLATORE PER CHIODI.....	322	BOYNTON PORT'AGHI.....	214	CANNULA D'ASPIRAZIONE PER BIOPSIA, BUIE.....	566
BENGOLEA PINZA EMOSTATICA.....	112	BOZEMANN PINZA PER TAMPONI.....	138	CANNULA D'ASPIRAZIONE POOLE.....	27
BENNETT ELEVATORE PER OSSA.....	283	BOZEMANN PORT'AGHI.....	211	CANNULA D'ASPIRAZIONE ZÖLLNER.....	337/1
BENSAUDE PROCTOSCOPO.....	565	BOZEMANN-DOUGLAS PINZA PER TAMPONI.....	138	CANNULA D'ASPIRAZIONE, ADSON.....	337
BENSON DIVARICATORE PER PILORO.....	544	BRACCIALE.....	295	CANNULA D'ASPIRAZIONE, ANDREW-PYNCHON.....	28
BERENS CHERATOMO.....	372	BRACCIO PORTALARINGOSCOPIO KLEINSASSER.....	36	CANNULA D'ASPIRAZIONE, BABY-YANKAUER.....	27
BERGMANN FORBICI PER BENDAGGI.....	69/1	BRAND ENUCLEATORE PER TENDINI.....	294	CANNULA D'ASPIRAZIONE, COOLEY.....	28
BERGMANN MARTELLO.....	272	BRAND STRUMENTI PER AFFERRARE TENDINI.....	293	CANNULA D'ASPIRAZIONE, DE BAKEY.....	28
BERKE PINZA MUSCOLARE.....	389	BRAUN CRANIOCLASTO.....	607	CANNULA D'ASPIRAZIONE, FERGUSSON.....	337
BERLINER MARTELLO DA PERCUSSIONE.....	24	BRAUN DEPRESSORE UTERINO.....	586	CANNULA D'ASPIRAZIONE, FRAZIER/FERGUSSON.....	337
BERNHARD PINZA FISSATELI.....	133	BRAUN PINZA PER ABBASSARE IL COLLO DELL'UTERO.....	582	CANNULA D'ASPIRAZIONE, PLESTER.....	338
BERRY PINZA TORCIFILI.....	319	BRAUN UNCINO SPEZZATORE.....	607	CANNULA D'ASPIRAZIONE, ROSEN.....	338
BETHUNE COSTOTOMO.....	481	BRAUN-STADLER FORBICI PER EPISIOTOMIA.....	64	CANNULA D'ASPIRAZIONE, YASARGIL.....	337/1
BICCHIERE GRADUATO.....	620	BREAST DIVARICATORE PER CHIRURGIA PLASTICA.....	198	CANNULA D'ASPIRAZIONE, HOUSE.....	337/2
BICCHIERE PER MEDICINALI.....	621	BREISKY SPECOLO VAGINALE.....	577	CANNULA LARINGEA.....	470
BIEMER APPROSSIMATORE.....	366	BRIDGE PINZA EMOSTATICA.....	116	CANNULA OCULISTICA JENSEN.....	394
BIEMER CLIPS PER VASI.....	361	BRISTOW ELEVATORE PER OSSA.....	290	CANNULA OCULISTICA MCINTYRE.....	394
BIEMER PINZA POSA CLIPS.....	361,363,364,366	BRODIE SPECILLO.....	199	CANNULA OCULISTICA PER IRRIGAZIONE ED ASPIRAZIONE BISHOP-HARMON.....	394/1
BIEMER-MÜLLER APPROSSIMATOR.....	363	BROPHY PINZA ANATOMICA.....	84	CANNULA OCULISTICA, LACRIMAL.....	394
BIER SEGA PER AMPUTAZIONE.....	296	BROPHY PINZA CHIRURGICA.....	84	CANNULA PER ASPIRAZIONE GUILLEN.....	433/1
BILL TRATTORE.....	604	BROWN PINZA PER TESSUTI.....	83	CANNULA PER BIOPSIA, MENGHINI.....	206
BILLEAU ANSA AURICOLARE.....	409	BROWN PORT'AGHI.....	209	CANNULA PER IRRIGAZIONE KILLIAN.....	433, 433/1
BIRCHER-GANSKE TENAGLIA PER OSSA.....	246	BRUENINGS COLTELLO PER TONSILLE.....	466	CANNULA PER IRRIGAZIONE SHEETS.....	394/2
BIRKETT PINZA EMOSTATICA.....	116	BRUENINGS ABBASSALINGUA.....	451	CANNULA PER IRRIGAZIONE, HARTMANN.....	433
BISHOP-HARMAN PINZA PER IRIDE.....	386	BRUENINGS INSERTO.....	472	CANNULA PER IRRIGAZIONE, SCHMID.....	338
BISHOP-HARMON CANNULA OCULISTICA PER IRRIGAZIONE ED ASPIRAZIONE.....	394/1	BRUENINGS PINZA PER SETTO NASALE.....	425	CANNULA PER IRRIGAZIONE, SIEBENMANN.....	433
BISTURI MONOUSO, STERILI.....	43	BRUENINGS SPECOLO AURICOLARE.....	401	CANNULA PER IRRIGAZIONE, SIMCOE.....	394
BISTURI PER FIBROMI, SEGOND.....	594	BRUNETTI SCALPELLO.....	268	CANNULA TRACHEALE, LUER.....	479
BISTURI, MANICO DI METALLO.....	46	BRÜNING-LUCAS SCALPELLO.....	260	CANNULA TRACHEALE, WAGENER-MOSHER.....	477
BLAKE CURETTA UTERINA.....	595	BRÜNING-LUCAS SCALPELLO.....	260	CANNULA TRACHEALE,CHEVALIER-JACK.....	479
BLAKE PINZA PER CALCOLI BILIARI.....	531	BRÜNING-LUCAS SGORBIA.....	260	CANNULA, LICHTWITZ.....	433
BLEFAROSTATO CLARK.....	370	BRUNNER COSTOTOMO.....	481	CAPLAN PINZA NASALE.....	428
BLEFAROSTATO LIEBERMANN.....	371	BRUNNER DIVARICATORE.....	167	CARMALT PINZA PER SCHEGGE.....	91
BLEFAROSTATO, ARRUGA.....	370	BRUNNER PINZA INTESTINALE.....	543	CAROLL PINZA PER AFFERRARE TENDINI.....	293
BLEFAROSTATO, BARRAQUER.....	370	BRUNNER SONDE CONDUTTRICE.....	221	CARPENTER COLTELLO PER TONSILLE.....	465
BLEFAROSTATO, BOWMAN.....	370	BRUNNER SONDE CONDUTTRICE.....	221	CASPAR DIVARICATORE PER SPINA CERVICALE.....	179
BLEFAROSTATO, CASTROVIEJO.....	371	BRUNS CURETTA TAGLIANTE.....	251, 254	CASPAR DIVARICATORE PER SPINA CERVICALE.....	180
BLEFAROSTATO, CRITCHETT.....	370	BRUNS FORBICI PER BENDAGGI.....	70	CASPAR PISTONI.....	258
BLEFAROSTATO, GRAEFE.....	370	BRYANT PINZA PER MEDICATURA.....	137	CASTANEDA NEONATAL PINZA VASCOLARE.....	527
BLEFAROSTATO, LANCASTER.....	371	BUCHWALD ABBASSALINGUA.....	451	CASTROVIEJO BLEFAROSTATO.....	371
BLEFAROSTATO, LISTER-BURCH.....	370	BUCK CURETTA AURICOLARE.....	407	CASTROVIEJO COLTELLO LANCEOLARE.....	372
BLEFAROSTATO, MELLINGER.....	370	BUCK LEVA PER CORPI ESTRANEI.....	412	CASTROVIEJO COMPASSO.....	380
BLEFAROSTATO, MELLINGER-AXENFELD.....	370	BUCK MARTELLO DA PERCUSSIONE.....	24	CASTROVIEJO FORBICI CORNEALI.....	79
BLEFAROSTATO, MUELLER.....	371	BUCK-GRAMCKO ELEVATORE PER OSSA.....	285	CASTROVIEJO PINZA CAPSULARE.....	391
BLEFAROSTATO, MURDOCK.....	370	BUIE CANNULA D'ASPIRAZIONE RETTALE.....	566	CASTROVIEJO PINZA FISSATRICE.....	390
BLEFAROSTATO, PARK.....	371	BULLDOG PINZA MINI DIETRICH.....	101	CASTROVIEJO PINZA PER SUTURA.....	392
BLEFAROSTATO, SMITH.....	370	BULLDOG PINZA, JOHNS-HOPKINS.....	104	CASTROVIEJO PORT'AGHI.....	215
BLEFAROSTATO, STEVENSON.....	371	BULLDOG PINZE ATRAUMATICHE.....	100	CASTROVIEJO ROMPIAMETTE.....	45
BLEFAROSTATO, WEEK.....	370	BÜLOW-GUNAR-HEY PINZA SERRATUBI A RULLI.....	130	CASTROVIEJO SPATOLA PER CICLODIALISI.....	379
BLEFAROSTATO, WILLIAMS.....	370	BUMM CURETTE UTERINI.....	597	CASTROVIEJO-MICRO PORT'AGHI.....	215
BLEFAROSTATO, ZIEGLER.....	371	BUNELL ENUCLEATORE PER TENDINI.....	292	CASTROVIEJO-STANDARD PORT'AGHI.....	216
BLOHMKE PINZA PER TONSILLE.....	467	BUNELL GUIDA PER TENDINI.....	294	CATETERE AURICOLARE, HARTMANN.....	408
BLOUNT ELEVATORE PER GINOCCHIO.....	289	BUNELL PERFORATORE A MANO.....	299	CATETERE METALLICO.....	555
BLOUNT ELEVATORE PER OSSA.....	288	BUNGE CUCCHIAIO PER ESTENTERAZIONE.....	378	CATETERE METALLICO, COXETER.....	555
BLUMENTHAL PINZA SGORBIA.....	236	BUNT PINZA PER STERILIZZAZIONE.....	227	CATLIN AMPUTATIONSMESSN.....	44
BODENHAMMER SPECOLO RETTALE.....	559	BURCH UNCINO DI FISSAZIONE.....	373	CAUTERIO WADSWORTH-TODD.....	378
BOEHLER ARCO PER ESTENSIONE.....	312	BURKE PINZA PER BIOPSIA.....	590	CAVO BIPOLORE.....	633
BOERMA FORCIPE.....	604	BUSHE CURETTA TAGLIANTE.....	256	CESOIA PER GESSI, STILLE.....	229
BOETTCHER FORBICI PER TONSILLE.....	59			CESOIA PER OSSA STILLE-HORSLEY.....	242
BÖHLER CESOIA PER OSSA.....	241	<b>C</b>		CESOIA PER OSSA STILLE-LISTON.....	242
BÖHLER PINZA SGORBIA.....	238	CACCIAVITE WILLIAMS.....	323	CESOIA PER OSSA, BOEHLER.....	241
BOIES ELEVATORE.....	277	CACCIAVITE, LANE.....	323, 324	CESOIA PER OSSA, LISTON.....	241
BONACCOLTO PINZA PER STRABISMO.....	385	CALAMITA OCULISTICA, REDA.....	395	CESOIA PER OSSA, MCINDOE.....	241
BONN PINZA PER IRIDE.....	387	CALIBRO.....	26	CESOIA PER OSSA, RUSKIN-LISTON.....	241
BONNEY PINZA ANATOMICA.....	88	CAMERA D'ARIA.....	295	CESOIA PER OSSA, SEMB.....	242
BONNEY PINZA CHIRURGICA.....	88	CANDELETTA DILATATRICE, DITTEL.....	554	CESOIA PER OSSA,COTTLE-K.....	241
BOSE DIVARICATORE TRACHEALE.....	476	CANDELETTA DILATATRICE, GUYON.....	554	CESTELLO.....	623
BOUCHERON SPECOLO AURICOLARE.....	399	CANDELETTA DILATATRICE, VAN BUREN.....	554	CESTELLO PER ENDOSCOPI.....	623
BOWMAN AGO PER DISCISIONE.....	374	CANFIELD COLTELLO PER TONSILLE.....	466	CESTELLO PER STERILIZZAZIONE.....	622
BOWMAN BLEFAROSTATO.....	370	CANNULA DA INIEZIONE.....	36	CHANDLER ELEVATORE.....	282
BOWMAN CHERATOMO.....	372	CANNULA D'ASPIRAZIONE.....	337/1	CHAPUT PINZA PER AFFERRARE TESSUTI.....	110
BOWMAN SPECILLO PER CANALE LACRIMALE.....	381	CANNULA D'ASPIRAZIONE KLEINSASSER.....	36	CHARNLEY DIVARICATORE ADDOMINALE.....	289



CHARRIERE SEGA PER AMPUTAZIONE.....	296	COLTELLO PER AMPUTAZIONE, CATLIN.....	44	CORONAL BLOW DIVARICATORE PER CHIRURGIA PLASTICA.....	198
CHEATLE PINZA PER STERILIZZAZIONE.....	227	COLTELLO PER AMPUTAZIONE, LANGENBECK.....	44	CORWIN-HEGAR PINZA TORCIFILI.....	319
CHELSEA-EATON PROCTOSCOPO.....	563	COLTELLO PER AMPUTAZIONE, REDA.....	44	CORYLLOS COSTOTOMO.....	480
CHERON PINZA PER MEDICATURA.....	137	COLTELLO PER CARTILAGINE E DISSEZIONE, VIRCHOW.....	48	CORYLLOS DIVARICATORE.....	166
CHERRY DIVARICATORE PER LAMINECTOMIA.....	488	COLTELLO PER CARTILAGINI, LANGENBECK.....	47	COS MIKRO-PINZA AURICOLARE.....	414
CHEVALIER-JACKSON CANNULA TRACHEALE.....	479	COLTELLO PER CATARATTA, DEUTSCHMANN.....	371	COSCIALE.....	295
CHEVALIER-JACKSON PINZA PER BRONCO-ESOFAGOSOFIA.....	473	COLTELLO PER CATARATTA, GRAEFE.....	371	COSTOTOMO.....	480
CHIAVE.....	266	COLTELLO PER CERVELLO.....	48	COSTOTOMO SAUERBRUCH-FREY.....	481
CHIAVI.....	313	COLTELLO PER CATARATTA, BARRAQUER.....	373	COSTOTOMO, BETHUNE.....	481
CHILDE PINZA PER AGRAFES.....	224	COLTELLO PER CHERATOPLASTICA, PAUFIQUE.....	373	COSTOTOMO, BRUNNER.....	481
CHIODI PER OSSA.....	309	COLTELLO PER DURA MADRE, KOOS.....	335	COSTOTOMO, CORYLLOS.....	480
CHIODI STEINMANN.....	307, 308	COLTELLO PER CHERATOPLASTICA, BARRAQUER.....	373	COSTOTOMO, GIERTZ-STILLE.....	481
CINELLI SCALPELLO PER SETTO.....	441	COLTELLO PER GESSI, ESMARCH.....	233	COSTOTOMO, GLUCK.....	480
CISTOTOMO, BECKER.....	375	COLTELLO PER GESSI, HOPKINS.....	233	COSTOTOMO, SAUERBRUCH.....	481
CISTOTOMO, GRAEFE.....	375	COLTELLO PER GESSI, REINER.....	233	COSTOTOMO, STILLE.....	480
CITELLI PINZA TAGLIANTE PER SETTO NASALE.....	430	COLTELLO PER GESSI, WIGMORE.....	229	COTTLE COLUMELLA PINZA.....	448
CLAR LAMPADA FRONTALE.....	22	COLTELLO PER GONIOTOMIA, BARKAN.....	373	COTTLE BULLDOG-FORBICI.....	56
CLARB BLEFAROSTATO 8CM.....	370	COLTELLO PER GONIOTOMIA, SCHEIE.....	373	COTTLE COLTELLO NASALE.....	435
CLAUS AGO PER TONSILLE.....	466	COLTELLO PER IRIDE, DEAN.....	372	COTTLE ELEVATORE PER SETTO.....	439
CLAYMAN UNCINO.....	376	COLTELLO PER IRIDE, KNAPP.....	372	COTTLE FORBICI NASALI.....	59
CLEVELAND PINZA SGOBRIA.....	235	COLTELLO PER IRIDE, ZIEGLER.....	372	COTTLE MARTELLO.....	273
CLIPS PER ANEURISMA YASARGIL.....	345-356	COLTELLO PER MENISCO, NEFF.....	292	COTTLE PINZA DA PRESA.....	410
CLIPS PER VASI, BIEMER.....	361	COLTELLO PER MENISCO, SMILLIE.....	292	COTTLE SCALPELLO PER SETTO.....	440
CLIPS PER VASI, MEHDORN.....	362	COLTELLO PER ORGANI.....	48	COTTLE SPECOLO NASALE.....	423
CLIPS PER VASI, MUELLER.....	364, 365	COLTELLO PER PERIOSTIO CON RASCHINO.....	47	COTTLE UNCINO NASALE.....	447
CLOWARD DIVARICATORE.....	178	COLTELLO PER RESEZIONE.....	47	COTTLE-JOSEPH ELEVATORE PER SETTO.....	439
CLOWARD DIVARICATORE PER CORPI VERTEBRALI.....	339	COLTELLO PER SETTO NASALE, FREER.....	434	COTTLE-KAZANJIAN CESOIA PER OSSA.....	241
CLOWARD PINZA TAGLIANTE PER LAMINECTOMIA.....	342	COLTELLO PER SETTO, BALLENGER.....	436	COTTLE-NEIVERT UNCINO NASALE.....	448
COAKLEY ANTRUM CURETTA.....	449	COLTELLO PER TONSILLE, ABRAHAM.....	466	COXETER CATERETTER METALLICO.....	555
COAKLEY TREQUARTO PER SENO MASCELLARE.....	204	COLTELLO PER TONSILLE, BRUENINGS.....	466	CRAFOOD-SELLORS PINZA EMOSTATICA.....	119
COBB CURETTA.....	252	COLTELLO PER TONSILLE, CANFIELD.....	466	CRAFOOD FORBICI POLMONARE.....	65/2
COBB PERIOSTOTOMO.....	280	COLTELLO PER TONSILLE, CARPENTER.....	465	CRAFOOD PINZA EMOSTATICA.....	118
COBB SGOBRIA.....	262	COLTELLO PER TONSILLE, DOUGLAS.....	466	CRANIOCLASTO, BRAUN.....	607
COLCLOUGH PINZA TAGLIANTE PER DISCHI INTERVERTEBRALI.....	344/1	COLTELLO PER TONSILLE, FISHER.....	466	CRANIOCLASTO, TARNIER.....	607
COLLER-CRILE PINZA EMOSTATICA.....	106	COLTELLO, PLESTER.....	418	CREGO ELEVATORE.....	282
COLLIER PELVIMETRO.....	605	COLTELLO, ROSEN.....	418	CRILE DIVARICATORE.....	140
COLLIER PORT'AGHI.....	208	COLTELLO, SCHUKNECHT.....	418	CRILE PINZA EMOSTATICA.....	107
COLLIN DINAMOMETRO.....	25	COLTELLO, TABB.....	418	CRILE PORT'AGHI.....	213
COLLIN DIVARICATORE.....	139	COLTELLO, WULLSTEIN.....	418	CRILE UNCINO PER NERVI.....	328
COLLIN DIVARICATORE ADDOMINALE.....	189/1	COLUMELLA PINZA, COTTLE.....	448	CRILE-MURRAY PORT'AGHI.....	209
COLLIN DIVARICATORE ADDOMINALE.....	190	COLVER PINZA PER TONSILLE.....	467	CRILE-RANKIN PINZA EMOSTATICA.....	107
COLLIN ISTEROMETRO.....	586	COMBINAZIONE PER DIAGNOSTICA CON ILLUMINAZIONE ALOGENA, RI-MINI.....	17	CRILE-WOOD PORT'AGHI.....	209
COLLIN LOKITTE DIVARICATORE ADDOMINALE.....	191	COMBINAZIONE PER DIAGNOSTICA CON ILLUMINAZIONE STANDARD ECO "T".....	16	CRITCHETT BLEFAROSTATO.....	370
COLLIN MARTELLO.....	270	COMBINAZIONE PER DIAGNOSTICA CON ILLUMINAZIONE STANDARD UNI I.....	13	CRUTCHFIELD PERFORATORE.....	327
COLLIN PELVIMETRO.....	605	COMBINAZIONE PER DIAGNOSTICA CON ILLUMINAZIONE STANDARD UNI II.....	14	CRUTCHFIELD PINZA PER TRAZIONE CRANIALE.....	327
COLLIN PINZA OMBELICALE.....	605	COMBINAZIONE PER DIAGNOSTICA CON ILLUMINAZIONE STANDARD UNI III.....	15	CUCCHIAIO AURICOLARE, GROSS.....	409
COLLIN PINZA PER AFFERRARE INTESTINI.....	539	COMPASSO, CASTROVIEJO.....	380	CUCCHIAIO OSTETRICO, SELLHEIM.....	607
COLLIN PINZA PER AFFERRARE L'UTERO.....	585	COMPASSO, IWANSON.....	624	CUCCHIAIO PER ABORTO, CUZZI.....	606
COLLIN PINZA PER AFFERRARE TESSUTI.....	110	COMPRESSORE STONE-WATT.....	545	CUCCHIAIO PER ABORTO, WALLICH.....	607
COLLIN PINZA PER AGRAFES.....	224	CONE PINZA PER CRANIOTOMIA.....	331	CUCCHIAIO PER ASPORTAZIONE RETINALE, ARRUGA.....	378
COLLIN PINZA PER MEDICATURA.....	137	CONNIN-AMSLER MARCATORE.....	380	CUCCHIAIO PER CALCOLI BILIARI MOOR.....	532
COLLIN PINZA TIRILINGUA.....	453	CONVERSE COLTELLO NASALE.....	448	CUCCHIAIO PER CALCOLI BILIARI, DESJARDINS.....	534
COLLIN SPECOLO VAGINALE.....	570	COOLEY DILATATORE.....	528	CUCCHIAIO PER CALCOLI BILIARI, FERGUSSON.....	533
COLLIN-DUVAL PINZA DA PRESA.....	85	COOLEY CANNULA D'ASPIRAZIONE.....	28	CUCCHIAIO PER CALCOLI BILIARI, LUER-KOERTE.....	533
COLLIN-HARTMANN DIVARICATORE.....	141	COOLEY DIVARICATORE.....	148	CUCCHIAIO PER CALCOLI BILIARI, MAYO.....	534
COLTELLO ADENOIDE BECKMANN.....	450	COOLEY DIVARICATORE COSTALE.....	487	CUCCHIAIO PER CATERATTA, BILLY.....	377
COLTELLO ADENOIDE, BARNHILL.....	450	COOLEY PINZA CARDIOVASCOLARE ATRAUMATICA.....	518, 519, 522	CUCCHIAIO PER CATERATTA, GRAEFE.....	377
COLTELLO ADENOIDE, ST. CLAIR-THOMSON.....	450	COOLEY PINZA PER CATETERI.....	510	CUCCHIAIO PER CATERATTA, KNAPP.....	378
COLTELLO AURICOLARE, POLITZER.....	408	COOLEY-DERRA PINZA PER ANASTOMOSI.....	519	CUCCHIAIO PER CATERATTA, WELLS.....	378
COLTELLO AURICOLARE, SEXTON.....	408	COOLEY-NEONATAL DIVARICATORE COSTALE.....	485	CUCCHIAIO PER ESTENTERAZIONE, BUNGE.....	378
COLTELLO FALCATO REDA.....	435	COOPER AGO PER LEGATURE.....	219	CUCCHIAIO PER MEDICINALI.....	621
COLTELLO INTEROSSEO.....	44	COPERCHIO PER PADELLA.....	621	CUCCHIAIO PER SANGUE.....	268
COLTELLO LANCEOLARE, BERENS.....	372	CORDA DI TRAZIONE.....	201	CUCCHIAIO UTERINO GOURDET.....	599
COLTELLO LANCEOLARE, BOWMAN.....	372	CORDES INSERTO.....	472	CUCCHIAIO UTERINO SCHRÖDER.....	595
COLTELLO LANCEOLARE, CASTROVIEJO.....	372			CUCCHIAIO UTERINO, SIMON.....	594
COLTELLO LANCEOLARE, JAEGER.....	372			CULLER SPATOLA PER IRIDE.....	378
COLTELLO LANCEOLARE, WHEELER.....	373			CURETTA ANTRUM.....	435
COLTELLO LANCEOLARE, ZIEGLER.....	373			CURETTA ANTRUM, COAKLEY.....	449
COLTELLO NASALE, CONVERSE.....	435			CURETTA AURICOLARE, BUCK.....	407
COLTELLO NASALE, COTTLE.....	435			CURETTA COBB.....	252
COLTELLO PER AMPUTAZIONE LISTON.....	44			CURETTA DA CALAZIO, AXENFELD.....	377



CURETTA DA CALAZIO, HEBRA .....	377	DE BAKEY PINZA VASCOLARE .....	493, 494, 495, 496, 497, .....498, 499, 500, 505, 507, 508, 514, 515, 516, 517,	DILATATORE UTERINO PRATT .....	580
CURETTA DA CALAZIO, MEYHOEFER .....	377	DE BAKEY PORT'AGHI .....	210	DILATATORE UTERINO SIMS .....	581
CURETTA PER ABORTO, PESTALOZZA .....	606	DE BAKEY, PINZA ATRAUMATICA BULLDOG .....	100	DILATATORE UTERINO WYLIE .....	581
CURETTA PER BIOPSIA ED ASPIRAZIONE .....	600	DE BAKEY, PINZE ATRAUMATICHE .....	98	DILATATORE VASCOLARE DEBAKEY .....	529
CURETTA PER BIOPSIA, HEANY .....	587	DE BOER DIVARICATORE COSTALE .....	486	DINAMOMETRO, COLLIN .....	25
CURETTA PER BIOPSIA, KEVORKIAN .....	587	DE LEE FORCIPE .....	602	DINGMAN ELEVATORE .....	463/3
CURETTA PER BIOPSIA, MOD.MÜNCHEN .....	587	DE MARTEL STRUMENTO CONDUTTRICE .....	330	DINGMANN ABBASSALINGUA .....	456
CURETTA PER BIOPSIA, NOVAK .....	587	DE MARTEL STRUMENTO CONDUTTRICE .....	330	DINGMANN APRIBOCCA .....	456
CURETTA PER BIOPSIA, RANDALL .....	587	DE MARTEL-WOLFSON PINZA PER ANASTOMOSI .....	546	DINGMANN DIVARICATORE .....	463
CURETTA PER CORPI ESTRANEI ALVIS .....	374	DEAN COLTELLO PER IRIDE .....	372	DINGMANN PERIOTOSTOMO .....	463
CURETTA PER IPOFISI .....	334	DEAN FORBICI PER TONSILLE .....	59	DINGMANN TENAGLIA PER OSSA .....	246
CURETTA PER LUPUS, FOX .....	608	DEAVER DIVARICATORE .....	145	DIPLOMAT SFGMOMANOMETRO .....	5
CURETTA PER LUPUS, PIFFARD .....	608	DEAVER FORBICI PER DISSEZIONE .....	52	DISSETTORE CORNEALE, PATON .....	373
CURETTA TAGLIANTE BRUNS .....	251, 254	DEAVER-GRIP DIVARICATORE .....	146	DISSETTORE CORNEALE, ELSCHNIG .....	373
CURETTA TAGLIANTE DOPPIA VOLKMANN .....	257	DEBAKEY FORBICI VASCOLARI .....	61	DISSETTORE CORNEALE, GILL .....	373
CURETTA TAGLIANTE VOLKMANN .....	251	DEBAKEY FORBICI VASCOLARI TC .....	60	DISSETTORE CORNEALE, GREEN .....	374
CURETTA TAGLIANTE WILLIGER .....	255	DEBAKEY PINZA PER ANASTOMOSI .....	505	DISSETTORE CORNEALE, SATO .....	373
CURETTA TAGLIANTE, BUSHE .....	256	DEBAKEY-BAHNSON PINZA ANEURISMA .....	506	DISSETTORE CORNEALE, TOOK .....	373
CURETTA TAGLIANTE, DAUBENSPECK .....	255	DEBAKEY-DIETHRICH MINI PINZA BULLDOG .....	101	DISSETTORE GORNEY .....	277
CURETTA TAGLIANTE, HALLE .....	253	DEBAKEY-MOSQUITO PINZA EMOSTATICA .....	509	DISSETTORE PER SACCO LACRIMALE, LANG .....	378
CURETTA TAGLIANTE, JACOBSON .....	257	DEBAKEY-PEAN PINZA EMOSTATICA .....	513	DISSETTORE PER TONSILLE, HURD .....	465
CURETTA TAGLIANTE, JANSEN .....	257	DEBAKEY-RANKIN PINZA EMOSTATICA .....	512	DISSETTORE PER TONSILLE, LOPEZ-REINKE .....	465
CURETTA TAGLIANTE, LEMPERS .....	256	DEBAKEY-SATINSKY PINZA PER OCCLUSIONE TANGENZIALE .....	502	DISSETTORE PER TONSILLE, YANKAUER .....	465
CURETTA TAGLIANTE, MARTINI .....	257	DEJERINE MARTELLO DA PERCUSSIONE .....	24	DISSETTORE, FISCH .....	420
CURETTA TAGLIANTE, SCHEDE .....	251	DELEE DIVARICATORE .....	574	DISSETTORE, PENFIELD .....	333
CURETTA TAGLIANTE, SCOVILLE .....	253	DEMEEL AGO PASSAFILI .....	315	DISTRIBUTORE PER PERFORATORI FILIFORME .....	310
CURETTA TAGLIANTE, SPINAL .....	253	DEMEEL STRUMENTO TENDIFILI .....	315	DISTRIBUTORE PER SPAZZOLINI .....	611
CURETTA TAGLIANTE, SPRATT .....	251	DENHART APRIBOCCA .....	454	DITTEL CANDELETTA DILATATRICE .....	554
CURETTA, FAULKNER .....	449	DENIS-BROWNE DIVARICATORE ADDOMINALE .....	185	DIVARICATORE .....	463/3
CURETTA, HOUSE .....	420	DEPRESSORE PER EPIGLOTTIDE, REICHERT .....	471	DIVARICATORE ADDOMINALE BABY GOSSET .....	181
CURETTE UTERINI, BLAKE .....	595	DEPRESSORE UTERINO, BRAUN .....	586	DIVARICATORE ADDOMINALE BALFOUR .....	182
CURETTE UTERINI, BUMM .....	597	DEPRESSORE UTERINO, SIMS .....	586	DIVARICATORE ADDOMINALE BALFOUR BABY .....	182
CURETTE UTERINI, RECAMIER .....	597	DERF PORT'AGHI .....	208	DIVARICATORE ADDOMINALE BALFOUR-US .....	184
CURETTE UTERINI, SIMS .....	597, 598	DERMATOMO, HUMBY .....	50	DIVARICATORE ADDOMINALE CHARNELY .....	289
CURETTE UTERINI, THOMAS .....	599	DERMATOMO, SILVER .....	50	DIVARICATORE ADDOMINALE COLLIN .....	190
CUSCO SPECOLO VAGINALE .....	570, 571	DERMATOMO, SCHINK .....	49	DIVARICATORE ADDOMINALE COLLIN-LOKTTITE .....	191
CUSHING (TAYLOR) PINZA TC .....	87	DERRA PINZA CARDIOVASCOLARE ATRAUMATICA .....	515	..... 187/1	
CUSHING DIVARICATORE .....	151	D'ERRICO UNCINO PER NERVI .....	329/2	DIVARICATORE ADDOMINALE DENIS-BROWNE .....	185
CUSHING DIVARICATORE .....	152	DESCHAMPS AGO PER LEGATURE .....	218	DIVARICATORE ADDOMINALE FRAZIER .....	181
CUSHING DIVARICATORE .....	153	DESJARDINS CUCCHIAIO PER CALCOLI BILIARI .....	534	DIVARICATORE ADDOMINALE GELPI .....	189/2
CUSHING PERFORATORE .....	299	DESJARDINS PINZA EMOSTATICA .....	121	DIVARICATORE ADDOMINALE GOSSET .....	181
CUSHING PINZA ANATOMICA .....	83	DESJARDINS PINZA PER CALCOLI BILIARI .....	531	DIVARICATORE ADDOMINALE HORGAN .....	183
CUSHING PINZA CHIRURGICA .....	83	DESJARDINS SONDA PER CALCOLI BILIARI .....	532	DIVARICATORE ADDOMINALE JACKSON BURROWS .....	189/2
CUSHING PINZA TAGLIANTE PER LAMINECTOMIA .....	340	DESMARRES DIVARICATORE .....	151	DIVARICATORE ADDOMINALE KIRSCHNER .....	185
CUSHING SPATOLA CEREBRALE .....	369	DESMARRES PINZA PER CALAZIO .....	393	DIVARICATORE ADDOMINALE RICARD .....	191
CUSHING UNCINO PER NERVI .....	328	DEUTSCHMANN COLTELLO PER CATARATTA .....	371	DIVARICATORE ADDOMINALE RIGBY .....	189/2
CUZZI CUCCHIAIO PER ABORTO .....	606	DEVILBISS PINZA PER CRANIOTOMIA .....	332	DIVARICATORE ADDOMINALE ROCHARD .....	186
CZERNY PINZA PER ABBASSARE IL COLLO DELL'UTERO .....	584	DEVILBISS PINZA PER CRANIOTOMIA .....	332	DIVARICATORE ADDOMINALE, DE BAKEY .....	189/1
CZERNY SPECOLO RETTALE .....	559	DIAPASON .....	404	DIVARICATORE ADDOMINALE, DOYEN .....	189/1
D		DIAPASON, HARTMANN .....	403	DIVARICATORE ADDOMINALE, GELPI .....	189/1
DANDY PINZA EMOSTATICA .....	109	DIAPASON, LUCAE .....	404	DIVARICATORE ADDOMINALE, SET COMPLETO, CON MORSETTI E VALVE .....	193
DANDY UNCINO PER NERVI .....	328	DIAPASON, REDA .....	403	DIVARICATORE ADDOMINALE, SET COMPLETO, CON SISTEMA DI MONTAGGIO .....	192
DARLING DIVARICATORE .....	178	DIAPASONN, RYDEL-SEIFFERT .....	404	DIVARICATORE ADSON .....	172
DARTIGUES PINZA PER AFFERRARE L'UTERO .....	585	DIAPASONN, RYDEL-SEIFFERT .....	404	DIVARICATORE ADSON .....	174
DASTOOR PINZA PER STRABISMO .....	386	DIAPASONN, RYDEL-SEIFFERT .....	404	DIVARICATORE ANALE, SMITH-BUIE .....	561
DAUBENSPECK CURETTA TAGLIANTE .....	255	DIAPASONN, RYDEL-SEIFFERT .....	404	DIVARICATORE AUFRANC-COBRA .....	289
DAVIDSON(SCAPULA) DIVARICATORE .....	166	DIAPASONN, RYDEL-SEIFFERT .....	404	DIVARICATORE COLLIN .....	139
DAVIEL CUCCHIAIO PER CATERATTA .....	377	DIAPASONN, RYDEL-SEIFFERT .....	404	DIVARICATORE COSTALE, COOLEY .....	487
DAVIS AGO PER CORPI ESTRANEI .....	374	DIAPASONN, RYDEL-SEIFFERT .....	404	DIVARICATORE COSTALE, COOLEY-NEONATAL .....	485
DAVIS DURA DISSETTORE .....	332	DIAPASONN, RYDEL-SEIFFERT .....	404	DIVARICATORE COSTALE, DE BOER .....	486
DAVIS PINZA PER STERILIZZAZIONE .....	227	DIAPASONN, RYDEL-SEIFFERT .....	404	DIVARICATORE COSTALE, FINOCHIETTO-BURFORD .....	483
DAVIS SPATOLA CEREBRALE .....	337	DIAPASONN, RYDEL-SEIFFERT .....	404	DIVARICATORE COSTALE, HAIGHT .....	487
DAVIS-BOYLE ABBASSALINGUA .....	455	DIAPASONN, RYDEL-SEIFFERT .....	404	DIVARICATORE COSTALE, MORSE .....	484
DAVIS-BOYLE APRIBOCCA .....	455	DIAPASONN, RYDEL-SEIFFERT .....	404	DIVARICATORE COSTALE, MORSE-FAVALORO .....	484
DAVIS-MEYER APRIBOCCA .....	457	DIAPASONN, RYDEL-SEIFFERT .....	404	DIVARICATORE COSTALE, MORSE-FAVALORO .....	484
DAY UNCINO .....	409	DIAPASONN, RYDEL-SEIFFERT .....	404	DIVARICATORE COSTALE, RIENHOFF-FINOCHIETTO .....	486
DE BAKEY PINZE ATRAUMATICHE BULLDOG .....	103	DIAPASONN, RYDEL-SEIFFERT .....	404	DIVARICATORE COSTALE, TUFFIER .....	487
DE BAKEY PINZE ATRAUMATICHE IN TITANIO .....	99	DIAPASONN, RYDEL-SEIFFERT .....	404	DIVARICATORE CUSHING .....	152
DE BAKEY CANNULA D'ASPIRAZIONE .....	28	DIAPASONN, RYDEL-SEIFFERT .....	404	DIVARICATORE CUSHING .....	153
DE BAKEY DILATATORE VASCOLARE .....	529	DIAPASONN, RYDEL-SEIFFERT .....	404	DIVARICATORE DELEE .....	574
DE BAKEY DIVARICATORE ADDOMINALE .....	189/1	DIAPASONN, RYDEL-SEIFFERT .....	404		





DIVARICATORE FINSEN .....	168	DIVARICATORE, COOLEY.....	148	DOYEN PINZA INTESTINALE .....	540
DIVARICATORE HARRINGTON-PEMBERTON .....	147	DIVARICATORE, CORYLLOS .....	166	DOYEN PINZA PER POLIPI UTERINI .....	585
DIVARICATORE KIRSCHNER.....	187	DIVARICATORE, CRILE .....	140	DOYEN SPECILLO SCANALATO .....	199
DIVARICATORE KOCHER .....	155	DIVARICATORE, CUSHING .....	151	DOYEN SPECOLO VAGINALE .....	574
DIVARICATORE KOCHER .....	159	DIVARICATORE, DARLING.....	178	DOYEN TIRAMIOMI.....	594
DIVARICATORE KOCHER .....	160	DIVARICATORE, DAVIDSON (SCAPULA).....	166	DOYEN-BABY PINZA INTESTINALE .....	540
DIVARICATORE KOCHER .....	163	DIVARICATORE, DEAYER.....	145	DOYEN-JANSEN(MOLT) APRIBOCCA.....	454
DIVARICATORE KÖNIG .....	153	DIVARICATORE, DEAYER GRIP .....	146	DOYEN-JANSEN(MOLT) APRIBOCCA.....	454
DIVARICATORE LANGENBECK .....	158	DIVARICATORE, DESMARRS .....	151	DOYEN-STILLE .....	167
DIVARICATORE LANGENBECK .....	159	DIVARICATORE, DINGMANN.....	463	DUBOIS FORBICI GINECOLOGICHE.....	63
DIVARICATORE MARTIN.....	175/1	DIVARICATORE, DOYEN.....	163	DUPLAY PINZA PER ABBASSARE IL COLLO	
DIVARICATORE MAYO-ADAMS .....	171	DIVARICATORE, DOYEN-STILLE .....	167	DELL'UTERO .....	582
DIVARICATORE MEYERDING.....	157	DIVARICATORE, FARABEU.....	139	DUPLAY PINZA PER MEDICATURA .....	134
DIVARICATORE MEYERDING .....	177	DIVARICATORE, FRITTSCH.....	163	DUPLEX STETOSCOPIO.....	23
DIVARICATORE MURPHY .....	156	DIVARICATORE, GI-L-VERNET .....	152	DUPUY-WEISS AGO PER TONSILLE .....	466
DIVARICATORE NORFOLK-NORDWICH .....	172	DIVARICATORE, GOELET .....	141	DURA DISSETTORE.....	332
DIVARICATORE OBWEGESER.....	460, 461	DIVARICATORE, GREEN.....	160	DURA DISSETTORE, DAVIS.....	332
DIVARICATORE PELVICO, ST.MARKS.....	165	DIVARICATORE, HARRINGTON.....	147	DURA DISSETTORE, FRAZIER .....	333
DIVARICATORE PER CHIRURGIA PLASTICA BREAST .....	198	DIVARICATORE, HEANEY.....	164	DURA DISSETTORE, HOEN.....	333
DIVARICATORE PER CHIRURGIA PLASTICA CORONAL		DIVARICATORE, HENLEY .....	170	DURA DISSETTORE, HORSLEY .....	333
BLOW .....	198	DIVARICATORE, HIBBS .....	164	DURA DISSETTORE, MILLIGAN .....	332
DIVARICATORE PER CHIRURGIA PLASTICA FERRIERA .....	197	DIVARICATORE, HOESSEL .....	167	DURA DISSETTORE, OLIVECRONA .....	332
DIVARICATORE PER CHIRURGIA PLASTICA FREEMAN .....	198	DIVARICATORE, HOFER .....	465	DURA DISSETTORE, SACHS.....	332
DIVARICATORE PER CHIRURGIA PLASTICA TEBBETS .....	197	DIVARICATORE, HOLZHEIMER.....	168	DURA DISSETTORE, TOENNIS .....	332
DIVARICATORE PER CHIRURGIA PLASTICA		DIVARICATORE, ISRAEL .....	162	DURA DISSETTORE, WOODSON .....	333
YANCOSKIE .....	198	DIVARICATORE, JANSEN .....	168	DURANTE PINZA DA PRESA.....	88
DIVARICATORE PER CORPI VERTREBRALI, CLOWARD .....	339	DIVARICATORE, KELLY .....	164	DUVAL PINZA DA PRESA.....	85
DIVARICATORE PER CORPI VERTREBRALI, INGE .....	339	DIVARICATORE, KELLY GRIP .....	142	DUVAL PINZA PER AFFERRARE INTESTINI .....	539
DIVARICATORE PER GESSI REDA.....	232	DIVARICATORE, KOCHER-LANGENBECK .....	159		
DIVARICATORE PER GESSI, BEESON .....	232	DIVARICATORE, KOERTE .....	162		
DIVARICATORE PER GESSI, HAGLUND-STILLE .....	232	DIVARICATORE, LAHEY .....	157		
DIVARICATORE PER GESSI, HENNIG.....	232	DIVARICATORE, LITTLE .....	157		
DIVARICATORE PER GUANCE,STERNBERG .....	453	DIVARICATORE, LOVE .....	465		
DIVARICATORE PER LA PROSTATA, YOUNG .....	550	DIVARICATORE, MATHIEU.....	141		
DIVARICATORE PER LABBRA .....	453	DIVARICATORE, MEYERDING .....	180		
DIVARICATORE PER LAMINECTOMIA SCOVILLE .....	196	DIVARICATORE, MIDDELDORFF .....	160		
DIVARICATORE PER LAMINECTOMIA		DIVARICATORE, MIKULICZ .....	163		
SCOVILLE-HAVERFIELD .....	196	DIVARICATORE, MOLLISON .....	171		
DIVARICATORE PER LAMINECTOMIA, CHERRY.....	488	DIVARICATORE, MORRIS .....	164		
DIVARICATORE PER SPINA CERVICALE CASPAR .....	179	DIVARICATORE, NAGER .....	465		
DIVARICATORE PER SPINA CERVICALE CASPAR .....	180	DIVARICATORE, OLLIER .....	162		
DIVARICATORE PER TIROIDE, SCHOENBORN.....	479	DIVARICATORE, PARKER .....	139		
DIVARICATORE PER TORACE, MERCEDES.....	489	DIVARICATORE, PLESTER.....	171		
DIVARICATORE PERKINS .....	168	DIVARICATORE, RAGNELL .....	140		
DIVARICATORE ROSE .....	140	DIVARICATORE, RAMUS .....	461		
DIVARICATORE SAUERBRUCH.....	164	DIVARICATORE, RICHARDSON.....	142		
DIVARICATORE SAUERBRUCH.....	166	DIVARICATORE, RICHARDSON GRIP .....	142		
DIVARICATORE SCALP-CONTOUR .....	169	DIVARICATORE, RICHARDSON-EASTMAN .....	142		
DIVARICATORE SPINALE, TAYLOR .....	291	DIVARICATORE, ROUX .....	139		
DIVARICATORE STRANDELL-STILLE .....	157	DIVARICATORE, ROUX-BABY .....	140		
DIVARICATORE TESSIER .....	463/3	DIVARICATORE, ROUX-MINI .....	140		
DIVARICATORE TRACHEALE .....	476	DIVARICATORE, SENN-GREEN .....	153		
DIVARICATORE TRACHEALE, ITERSON.....	477	DIVARICATORE, SENN-MILLER .....	143		
DIVARICATORE TRACHEALE, JACKSON.....	476	DIVARICATORE, SIMON.....	164		
DIVARICATORE TRACHEALE, NEWS .....	477	DIVARICATORE, SPINA-NASALIS .....	461		
DIVARICATORE TRAVERS .....	172	DIVARICATORE, VOLKMANN .....	153		
DIVARICATORE TUFFIER.....	147	DIVARICATORE, VOLKMANN .....	154		
DIVARICATORE VESCICALE, LEGUE .....	553	DIVARICATORE, WEITLANER .....	169		
DIVARICATORE VESCICALE, MILLIN .....	552	DIVARICATORE, WEITLANER-WULLSTEIN.....	169		
DIVARICATORE VESCICALE, MILLIN .....	553	DIVARICATORE, ZENKER .....	161		
DIVARICATORE VESCICALE, THOMSON-WALKER.....	552	DIVARICATORE,US-ARMY PARKER-LANG.....	141		
DIVARICATORE VESCICALE,JUDD-MASSON .....	552	DIVISORE PER CRANIO .....	267		
DIVARICATORE VOLKMANN, .....	156	DIX SGORBIA PER CORPI ESTRANEI .....	374		
DIVARICATORE WULLSTEIN .....	171	DIX STRUMENTI PER CORPI ESTRANEI.....	380		
DIVARICATORE, ADSON.....	173	DOUGHTY ABBASSALINGUA .....	458		
DIVARICATORE, ALM.....	168	DOUGLAS COLTELLO PER TONSILLE .....	466		
DIVARICATORE, ANDERSON-ADSON.....	172	DOUGLAS PINZA DEPILATORIA .....	395		
DIVARICATORE, BECKMANN .....	176	DOYEN DIVARICATORE .....	163		
DIVARICATORE, BECKMANN-ADSON .....	175	DOYEN DIVARICATORE ADDOMINALE .....	189/1		
DIVARICATORE, BECKMANN-EATON.....	176	DOYEN FORBICI GINECOLOGICHE .....	63		
DIVARICATORE, BRUNNER .....	167	DOYEN PERIOTOTOMO .....	278		
DIVARICATORE, CLOWARD .....	178	DOYEN PERIOTOTOMO .....	278		
DIVARICATORE, COLLIN HARTMANN .....	141	DOYEN PINZA FISSATELI.....	133		

ELEVATORE QUERVAIN.....	275	FISCH UNCINO.....	335	FORBICI PER DISSEZIONE, LEXER.....	53
ELEVATORE SEBILEAU.....	275	FISCH DISSETTORE.....	420	FORBICI PER DISSEZIONE, LEXER-BABY.....	53
ELEVATORE, ALDERDYCE.....	282	FISCHER PINZA PER IRIDE.....	384	FORBICI PER DISSEZIONE, LEXER-BABY TC.....	53
ELEVATORE, BOIES.....	277	FISH SPECILLO.....	199	FORBICI PER DISSEZIONE, MAYO-NOBLE.....	52
ELEVATORE, CREGO.....	282	FISHER COLTELLO PER TONSILLE.....	466	FORBICI PER DISSEZIONE, METZENBAUM.....	53/1
ELEVATORE, FREER.....	434	FOERSTER PINZA PER IRIDE.....	383	FORBICI PER DISSEZIONE, METZENBAUM FINO.....	53/1
ELEVATORE, KEY.....	282	FOERSTER PINZA PER MEDICATURA.....	136	FORBICI PER DISSEZIONE, METZENBAUM TC.....	53/1
ELEVATORE, LEMPERT.....	420	FOMON FORBICI NASALI.....	58	FORBICI PER DISSEZIONE, TOENNIS-ADSON.....	65
ELEVATORE, MCDONALD, 19CM.....	283	FOMON FORBICI PER RINOPLASTICA.....	65/1	FORBICI PER DISSEZIONE, WELLER.....	53/2
ELEVATORE, MURPHY-LANE.....	283	FOMON PERIOSTOTOMO.....	277	FORBICI PER DISSEZIONE, METZENBAUM FINO TC.....	53/1
ELEVATORE, SAYRE.....	281	FOMON RASPA NASALE.....	444	FORBICI PER DURAMADRE, SCHMIEDEN-TAYLOR.....	65/1
ELEVATORE, WATSON-CHEYNE.....	283	FOMON SCALPELLO PER SETTO.....	441	FORBICI PER ENTEROTOMIA.....	66
ELLIOT FORCIPE.....	602	FOMON TC RASPA NASALE.....	445	FORBICI PER EPISIOTOMIA, BRAUN-STADLER.....	64
ELLIS SGORBIA PER CORPI ESTRANEI.....	374	FOMON UNCINO PER LA PELLE.....	447/1	FORBICI PER EPISIOTOMIA, WALDMANN.....	64
ELSCHING DISSETTORE CORNEALE.....	373	FORBICE PER IL SETTO NASALE, KILLIAN.....	471	FORBICI PER FILO DI METALLO E LAMIERA, UNIVERSAL.....	67
ELSCHING SPATOLA PER CICLODIALISI.....	379	FORBICE PER LE UNGHIE.....	609	FORBICI PER INCISIONE.....	52
ELSCHNIG PINZA CAPSULARE.....	391	FORBICE PER PELLE.....	610	FORBICI PER ISTERECTOMIA, WERTHEIM.....	63
ELSCHNIG PINZA FISSATRICE.....	389	FORBICI BULLDOG COTTLE.....	56	FORBICI PER LEGATURE, HEATH.....	66
EMMETT UNCINO PER FISTOLE.....	594	FORBICI CORNEALI, CASTROVIEJO.....	79	FORBICI PER LEGATURE, LITTAUER.....	66
ENDOSPECOLO KOGAN.....	577	FORBICI GINECOLOGICHE, DOYEN.....	63	FORBICI PER LEGATURE, NORTHBENT.....	66
ENGL SEGÀ PER GESSI.....	229	FORBICI GINECOLOGICHE, DUBOIS.....	63	FORBICI PER LEGATURE, SPENCER.....	66
ENUCLATORE PER TENDINI, BRAND.....	294	FORBICI GINECOLOGICHE, SIEBOLD.....	62	FORBICI PER NEUROCHIRURGIA.....	65
ENUCLATORE PER TENDINI, BUNELL.....	292	FORBICI GINECOLOGICHE, SIMS.....	62	FORBICI PER NEUROCHIRURGIA, STRULLY.....	65
EPPER OSTEOTOMI.....	464/2	FORBICI GINGIVALI, GOLDMAN-FOX.....	67	FORBICI PER OFTALMOLOGIA.....	57
EPPENDORFER PINZA PER BIOPSIA.....	590	FORBICI GINGIVALI, LA GRANGE.....	69	FORBICI PER OFTALMOLOGIA GRADLE.....	57
ERRICO PERFORATORE.....	299	FORBICI GINGIVALI, LOCKKLIN.....	69	FORBICI PER OFTALMOLOGIA, AEBLI.....	58
ESMARCH BENDA PER COMPRESSIONE.....	297	FORBICI GINGIVALI, QUINBY.....	67	FORBICI PER OFTALMOLOGIA, STEVENS.....	58
ESMARCH COLTELLO PER GESSI.....	233	FORBICI GRAEFE.....	56	FORBICI PER PARAMETRIO.....	63
ESMARCH FORBICI PER BENDAGGI.....	69/2	FORBICI NASALI.....	429	FORBICI PER RINOPLASTICA FOMON.....	65/1
ESTENSIONE DELL'ARTICOLAZIONE.....	188	FORBICI NASALI, COTTLE.....	59	FORBICI PER STERNO SCHUMACHER.....	481
ESTRATTATORE, KUENTSCHER.....	322	FORBICI NASALI, FOMON.....	58	FORBICI PER STRABISMO.....	58
ETHICON PINZA APPLICATORE CLIPS.....	524, 525	FORBICI NASALI, HEYMAN.....	58	FORBICI PER STRABISMO.....	58
EVES SERRANODI PER TONSILLE.....	468	FORBICI OCULISTICHE WESTCOTT.....	75	FORBICI PER TONSILLE.....	59
EXACTA SFIGMOMANOMETRO.....	8	FORBICI OCULISTICHE, BARRAQUER.....	75	FORBICI PER TONSILLE, BOETTCHER.....	59
		FORBICI OCULISTICHE, NOYES.....	75	FORBICI PER TONSILLE, DEAN.....	59
		FORBICI OCULISTICHE, VANNAS.....	79	FORBICI PER TONSILLE, GOOD.....	59
<b>F</b>		FORBICI OCULISTICHE, WECKER.....	75	FORBICI PER TONSILLE, PRINCE.....	59
FACE LIFT FORBICI FREEMAN.....	74	FORBICI PER BENDAGGI.....	70	FORBICI POLMONARE, CRAFTOORD.....	65/2
FACE LIFT FORBICI GORNEY.....	73	FORBICI PER BENDAGGI, BERGMANN.....	69/1	FORBICI TORACALI, THOREK.....	65/2
FACE LIFT FORBICI KAYE.....	73	FORBICI PER BENDAGGI, BRUNS.....	70	FORBICI VASCOLARI DEBAKEY TC.....	60
FACE LIFT FORBICI REES.....	73	FORBICI PER BENDAGGI, ESMARCH.....	69/2	FORBICI VASCOLARI, DE BAKEY.....	61
FANSLER PROCTOSCOPO.....	565	FORBICI PER BENDAGGI, KNOWLES.....	70	FORBICI VASCOLARI, DIETRICH.....	60
FARABEUF DIVARICATORE.....	139	FORBICI PER BENDAGGI, LISTER.....	69/1	FORBICI VASCOLARI, FAVALORO.....	61
FARABEUF PERIOSTOTOMO.....	274	FORBICI PER BENDAGGI, LORENZ.....	70	FORBICI VASCOLARI, KELLY.....	61
FARABEUF TENAGLIA PER OSSA.....	243	FORBICI PER BENDAGGI, REDA EXCENTER.....	69/2	FORBICI VASCOLARI, KLINCKENBERG-LOTH.....	65/2
FARABEUF-COLLIN PERIOSTOTOMO.....	274	FORBICI PER BENDAGGI, SEUTIN.....	69/2	FORBICI VASCOLARI, POTTS-DE MARTEL.....	59
FARABEUF-LAMBOTTE TENAGLIA PER OSSA.....	243	FORBICI PER BENDAGGI, SMITH US ARMY.....	69/1	FORBICI VASCOLARI, POTTS-SMITH.....	61
FARRELL PORTACOTONE.....	203	FORBICI PER BENDAGGI, UNIVERSAL.....	70	FORBICI VASCOLARI, SATINSKY.....	62
FAULKNER CURETTA.....	449	FORBICI PER BENDAGGI, UNIRIS.....	54	FORBICI WAGNER.....	67
FAURE PINZA PER BIOPSIA.....	588	FORBICI PER BENDAGGI, JOSEPH.....	54	FORCIPE, BARTON.....	603
FAURE PINZA PERITONEALE.....	123	FORBICI PER BENDAGGI, KILNER.....	54	FORCIPE, BOERMA.....	604
FAVALORO FORBICI VASCOLARI.....	61	FORBICI PER BENDAGGI, REYNOLDS.....	54	FORCIPE, DE LEE.....	602
FEHLAND PINZA INTESTINALE.....	542	FORBICI PER BENDAGGI, SANVENERO.....	54	FORCIPE, ELLIOT.....	602
FEILCHENFELD PINZA PER SCHEGGE.....	91	FORBICI PER BENDAGGI, STANDARD.....	51	FORCIPE, KIELLAND.....	602
FELDHEIM PINZA PER OSSA.....	249	FORBICI PER BENDAGGI, SYSTRUNK.....	66	FORCIPE, KIELLAND-LUIKART.....	603
FERGUSSON CUCCHIAIO PER CALCOLI BILIARI.....	533	FORBICI PER BENDAGGI, FERGUSSON.....	66	FORCIPE, LUIKART.....	603
FERGUSSON FORBICI PER CHIRURGIA.....	66	FORBICI PER BENDAGGI, METZENBAUM.....	54	FORCIPE, MCLEAN.....	603
FERGUSSON FRAZIER CANNULA D'ASPIRAZIONE.....	337	FORBICI PER BENDAGGI, SYSTRUNK.....	66	FORCIPE, MCLEAN-LUIKART.....	603
FERGUSSON PINZA EMORROIDALE.....	109	FORBICI PER BENDAGGI, TUCKER.....	603	FORCIPE, MCLEAN-TUCKER.....	603
FERGUSSON TENAGLIA PER OSSA.....	243	FORBICI PER BENDAGGI, UMBELICALE, BUSCH.....	64	FORCIPE, MCLEAN-TUCKER-LUIKART.....	603
FERRIERA DIVARICATORE PER CHIRURGIA PLASTICA.....	197	FORBICI PER BENDAGGI, UMBELICALE, MOD.USA.....	64	FORCIPE, NAEGELE.....	602
FERRIS-SMITH PINZA CHIRURGICA.....	84	FORBICI PER BENDAGGI, UMBELICALE, SCHUMACHER.....	64	FORCIPE, PIPER.....	604
FERRIS-SMITH PINZA TAGLIANTE PER LAMINECTOMIA.....	343	FORBICI PER BENDAGGI, UMBELICALE, BEEBEE.....	68	FORCIPE, SIMPSON.....	602
FERRIS-SMITH-KERRISON PINZA TAGLIANTE PER DISCHI INTERVERTEBRALI.....	344, 344/2	FORBICI PER DISSEZIONE.....	52	FORCIPE, SIMPSON-BRAUN.....	602
FICHOCHIETTO-BABY DIVARICATORE COSTALE.....	482	FORBICI PER DISSEZIONE DEAYER.....	52	FORCIPE, SIMPSON-LUIKART.....	603
FILO PER OSSA.....	314	FORBICI PER DISSEZIONE MAYO.....	52	FORCIPE, WRIGLEY.....	602
FINOCCHIETTO DIVARICATORE COSTALE.....	482, 484	FORBICI PER DISSEZIONE MAYO, TC.....	52	FOREGGER LARINGSOCOPIO.....	29
FINOCCHIETTO PINZA PER BRONCHI.....	490	FORBICI PER DISSEZIONE MAYO-STILLE.....	52	FOREGGER LARINGSOCOPIO SET.....	31
FINOCCHIETTO DIVARICATORE COSTALE.....	484	FORBICI PER DISSEZIONE MAYO-STILLE.....	52	FOX CURETTA PER LUPUS.....	608
FINOCCHIETTO PORT'AGHI.....	211	FORBICI PER DISSEZIONE MAYO-STILLE, TC.....	52	FRAENKEL INSERTO.....	472
FINOCCHIETTO-BURFORD DIVARICATORE COSTALE.....	483	FORBICI PER DISSEZIONE METZENBAUM.....	53/1	FRAENKEL PINZA PER POLIPI LARINGEI.....	471
FINSEN DIVARICATORE.....	168	FORBICI PER DISSEZIONE, JORGENSEN.....	53	FRANCIS AGO PER CORPI ESTRANEI.....	374



FRANKLIN-SILVERMANN AGO PER BIOPSIA .....	206	GRAFFA PER IL CUIOIO CAPELLUTO, RANEY .....	327	HEIFETZ SPATOLA CEREBRALE .....	369
FRAZIER DIVARICATORE ADDOMINALE .....	181	GRAHAM UNCINO PER NERVI .....	329	HEIMING PINZA PER CALCOLI RENALI .....	536
FRAZIER DURA DISSETTORE .....	333	GRAIG PINZA NASALE .....	426	HEISS PINZA EMOSTATICA .....	112
FRAZIER UNCINO PER LA PELLE .....	149	GRAVE SPECOLO VAGINALE .....	570	HEISTER APRIBOCCA .....	454
FREEMAN DIVARICATORE PER CHIRURGIA PLASTICA .....	198	GRAY PINZA EMOSTATICA .....	121	HENKE ELEVATORE PER TONSILLE .....	465
FREEMAN FACE LIFT FORBICI .....	74	GREEN DISSETTORE CORNEALE .....	374	HENLEY DIVARICATORE .....	170
FREER COLTELLO PER SETTO NASALE .....	434	GREEN DIVARICATORE .....	160	HENNIG DIVARICATORE PER GESSI .....	232
FREER ELEVATORE .....	434	GREEN PINZA FISSATRICE .....	390	HEPP-SCHEIDEL MICRO FORBICI .....	78
FREER ELEVATORE PER SETTO .....	437	GREEN UNCINO PER IL STRABISMO .....	375	HERRICK PINZA PER PUNCOLO RENALE .....	123
FREER SCALPELLO PER SETTO .....	.....	GREEN-ARMYTAGE PINZA UTERINA PER EMOSTASI .....	605	HESS PINZA CAPSULARE .....	391
FREER UNCINO PER LA PELLE .....	448	GREGORY PINZA CARDIOVASCOLARE ATRAUMATICA .....	517	HESS PINZA PER IRIDE .....	384
FRENZEL ABBASSALINGUA .....	451	GREVEN MIKRO-PINZA AURICOLARE .....	414	HESS UNCIÓN PER NERVI .....	329/1
FRENZEL OCCHIALI NISTAGMO .....	20	GROSS CUCCHIAIO AURICOLARE .....	409	HEYMANN PINZA PER SETTO NASALE .....	425
FRIEDMANN MINI PINZA SGORBJA .....	234	GROSS-MAIER PINZA PER MEDICATURA .....	134	HEYMANN FORBICI NASALI .....	58
FRIEDMANN SPECOLO VAGINALE .....	577	GRUBER SPECOLO AURICOLARE .....	399	HEYMANN-KNIGHT PINZA AURICOLARE .....	425
FRITSCH DIVARICATORE .....	163	GUAINA PER VITI .....	325	HEYWOOD-SMITH PINZA PER EMORROIDI .....	567
FRYKHOLM PINZA SGORBJA .....	240	GUIDA CONDUTTRICE .....	321	HIBBS OSTEOTOMO .....	265
FUCHS PINZA CAPSULARE .....	391	GUIDA TENDINI, BUNELL .....	294	HIBBS DIVARICATORE .....	164
FUCHSIG PINZA EMOSTATICA .....	113	GUILLEN CANNULA PER ASPIRAZIONE .....	433/1	HIBBS SCALPELLO .....	265
<b>G</b>					
GALLAHER RASPA NASALE .....	446	GUTHRIE UNCINO PER LA PELLE .....	149	HIBBS SGORBJA .....	265
GASS UNCINO .....	376	GUYON CANDELETTA DILATRICE .....	554	HILL-FERGUSON SPECOLO RETTALE .....	560
GAUSS PINZA PER IL CUIOIO CAPELLUTO .....	605	GUYON INTRODOTTORE PER CATETERI .....	554	HIRSCHMAN SPATOLA PER CICLODIALISI .....	379
GELPI DIVARICATORE ADDOMINALE .....	189/1	GUYON PINZA EMOSTATICA .....	122	HIRSCHMANN ANOSCOPO .....	562
GELPI DIVARICATORE ADDOMINALE .....	189/2	GUYON PINZA RENALE .....	122	HOEN DURA DISSETTORE .....	333
GEMINI PINZA EMOSTATICA .....	115	GUYTON-LUNDGAARD SCLEROTOMO .....	373	HOESEL PORT'AGHI .....	213
GERALD PINZA ANATOMICA .....	86	<b>H</b>			
GERALD PINZA CHIRURGICA .....	87	HABERER SPATOLA ADDOMINALE E INTESTINALE .....	143/1	HOESEL PORT'AGHI .....	213
GERSTER PINZA PER OSSA .....	250	HAGLUND-STILLE DIVARICATORE PER GESSI .....	232	HOFER DIVARICATORE .....	465
GERZOG MARTELLO .....	270	HAIGHT DIVARICATORE COSTALE .....	487	HOFFMANN PINZA SERRATUBI .....	624
GHIGLIOTTINA PER TAGLIARE FILI 32CM .....	320	HAJEK MARTELLO .....	273	HOHMANN MINI ELEVATORE PER OSSA .....	286
GIERTZ-STILLE COSTOTOMO .....	481	HAJEK SCALPELLO PER SETTO .....	442/1	HOLINGER LARINGOSCOPIO PER OPERAZIONE .....	37
GIGLI SEGA .....	332	HAJEK-BALLENGER ELEVATORE PER SETTO .....	439	HOLLINGER PORTATORE DI LUCE .....	37
GILL DISSETTORE CORNEALE .....	373	HAJEK-KOFLER PINZA SFENOIDALE .....	430, 431	HOLSHER UNCINO PER RADICI DEI NERVI .....	329/1
GILL PINZA PER IRIDE .....	384	HALLE CURETTA TAGLIENTE .....	253	HOLTH PINZA TAGLIENTE PER CAPSULA .....	380
GILL-ARRUGA PINZA CAPSULARE .....	390	HALLE ELEVATORE PER SETTO .....	437	HOLZBACH PINZA PER ISTERECTOMIA .....	126
GILL-HESS PINZA PER IRIDE .....	384	HALSEY PORT'AGHI .....	208	HOLZBACH PINZA PER ISTERECTOMIA .....	126
GILLIES PINZA CHIRURGICA .....	86	HALSTED-MOSQUITO PINZA EMOSTATICA .....	105	HOLZHEIMER DIVARICATORE .....	168
GILLIES PORT'AGHI .....	212	HANK DILATATORE UTERINO .....	580	HOPKINS COLTELLO PER GESSI .....	233
GILLIES UNCINO PER LA PELLE .....	448	HARGIS ELEVATORE PER PERIOSTIO .....	463/2	HORGAN DIVARICATORE ADDOMINALE .....	183
GIL-VERNET DIVARICATORE .....	152	HARGIS SEPERATORE PER IL CORPO .....	.....	HORIZON PINZA APPLICATORE CLIPS .....	524, 525
GIUNTO DI PROLUNGAMENTO .....	299	MANDIBOLARE .....	463/6	HORSLEY DURA DISSETTORE .....	333
GLOVER BULLDOG PINZA ATRAUMATICA .....	100	HARKEN PINZA AURICOLA .....	503	HÖSEL DIVARICATORE .....	167
GLOVER BULLDOG PINZA ATRAUMATICA .....	103	HARMS, SONDA .....	381	HOUSE CANNULA D'ASPIRAZIONE .....	337/2
GLOVER PINZA VASCOLARE .....	515	HARRINGTON DIVARICATORE .....	147	HOUSE CURETTA .....	420
GLUCK COSTOTOMO .....	480	HARRINGTON PINZA PER BRONCHI .....	490	HOWARTH ELEVATORE PER SETTO .....	438
GOELET DIVARICATORE .....	141	HARRINGTON-PEMBERTON DIVARICATORE .....	147	HUBER MANICO UNIVERSALE .....	472
GOLDMANN-FOX FORBICI GINGIVALI .....	67	HARTMANN ABBASSALINGUA .....	452	HUDSON MANICO A T .....	300
GOMEL MICRO FORBICI .....	80	HARTMANN CANNULA PER IRRIGAZIONE .....	433	HUDSON PERFORATORE A MANO .....	299
GOMEL MICROPINZA CHIRURGICA .....	96	HARTMANN CATETERE AURICOLARE .....	408	HULKA PINZA PER ABBASSARE IL COLLO .....	.....
GONIOMETRO PER LE DITA .....	25	HARTMANN DIAPASON .....	403	DELL'UTERO .....	583
GONIOMETRO, MOELTGEN .....	25	HARTMANN PINZA PER CORPI ESTRANEI .....	412	HUMBY DERMATOMO .....	50
GOOD FORBICI PER TONSILLE .....	59	HARTMANN PINZA EMOSTATICA .....	104	HUNTER PINZA PER SCHEGGE .....	91
GOODELL DILATATORE UTERINO .....	581	HARTMANN PINZA PER POLIPI .....	424	HURD DISSETTORE PER TONSILLE .....	465
GORNEY DISSETTORE .....	277	HARTMANN SPECOLO AURICOLARE .....	399	<b>I</b>	
GORNEY FACE LIFT FORBICI .....	73	HARTMANN SPECOLO NASALE .....	422	I.U.D. PINZA DA PRESA FLESSIBILE, SERPENTINE .....	593
GOSSET DIVARICATORE ADDOMINALE .....	181	HARTMANN-HALLE SPECOLO NASALE .....	421	I.U.D. UNCINO ESTRATTORE .....	593
GOURDET CUCCHIAIO UTERINO .....	599	HARTMANN-HOFFMANN PINZA PER CORPI .....	.....	IMPATTATORE .....	322
GRADLE FORBICI PER OFTALMOLOGIA .....	57	ESTRANEI .....	412	IMPATTATORE / ESTRATTORE .....	322
GRADLE PINZA DEPILTORIA .....	395	HARTMANN-WULLSTEIN PINZA PER CORPI .....	.....	IMPATTATORE FINALE, KUENTSCHER .....	321
GRAEFÉ BLEFAROSTATO .....	370	ESTRANEI .....	412	INGE DIVARICATORE PER CORPI VERTEBRALI .....	339
GRAEFÉ CISTOTOMO .....	375	HAUGH MIKRO-PINZA AURICOLARE .....	414	INSERTO, BARACANI .....	472
GRAEFÉ COLTELLO LANCEOLARE .....	372	HAYES PINZA PER ANASTOMOSI DEL RETTO .....	545	INSERTO, BRUENINGS .....	472
GRAEFÉ COLTELLO LANCEOLARE .....	372	HEANEY PINZA PER ISTERECTOMIA .....	126	INSERTO, CORDES .....	472
GRAEFÉ COLTELLO PER CATARATTA .....	371	HEANEY PORT'AGHI .....	210	INSERTO, FRAENKEL .....	472
GRAEFÉ CUCCHIAIO PER CATARATTA .....	377	HEANY CURETTA PER BIOPSIA .....	587	INSERTO, FRAENKEL .....	472
GRAEFÉ FORBICI .....	56	HEANY DIVARICATORE .....	164	INSERTO, KRAUSE .....	472
GRAEFÉ PINZA DA PRESA .....	83	HEANY-BALLENTEINE PINZA PER ISTERECTOMIA .....	127	INSERTO, LANGE .....	472
GRAEFÉ PINZA FISSATRICE .....	389	HEATH FORBICI PER LEGATURE .....	66	INSERTO, SCHEINMANN .....	472
GRAEFÉ PINZA PER IRIDE .....	382	HEATH MARTELLO .....	273	INSERTO, SCHUMACHER .....	472
GRAEFÉ UNCINO .....	149	HEBRA CURETTA DA CALAZIO .....	377	INSERTO, SEIFERT .....	472
GRAEFÉ UNCINO PER IL STRABISMO .....	375	HEGAR DILATATORE UTERINO .....	578, 579	INSOFFIATORE D'ARIA, POLITZER .....	406
		HEGENBARTH PINZA PER AGRAFES .....	224	INSOFFIATORE PER POLVERE, KABIERSKE .....	405
				INSTRU-CARE OLIO PER STRUMENTI .....	634



INTRODUTTORE PER CATETERI GUYON .....	554	KEINSASSER LARINGOSCOPIO PER OPERAZIONE .....	35	KOGAN ENDOSPECOLO .....	577
IOWA AGO DI GUIDA .....	206	KEITH AGO .....	223	KÖNIG DIVARICATORE .....	153
IOWA PINZA PER ABBASSARE IL COLLO DELL'UTERO .....	584	KELLY DIVARICATORE .....	164	KÖNIG ELEVATORE PER OSSA .....	284
IRIS FORBICI .....	54	KELLY FORBICI VASCOLARI .....	61	KÖNIG PERIOSTOTOMO .....	276
IRIS FORBICI, KNAPP .....	55	KELLY GRIP DIVARICATORE .....	142	KÖNIG SPECILLO DI GUIDA SCANALATO .....	221
IRIS FORBICI, LITTLER .....	55	KELLY PINZA EMOSTATICA .....	106	KOOS COLTELLO PER DURA MADRE .....	335
IRIS SUPERCUT FORBICI .....	72	KELLY PINZA PER POLIPI UTERINI .....	585	KÖRTE SPATOLA ADDOMINALE ED INTESTINALE .....	143/1
ISRAEL DIVARICATORE .....	162	KELLY PROCTOSCOPIO .....	562, 563	KRAUSE INSERTO .....	472
ISTEROMETRO VALLEIX .....	586	KELLY-RANKIN PINZA EMOSTATICA .....	106	KRAUSE SERRANODI .....	411
ISTEROMETRO, COLLIN .....	586	KERN TENAGLIA PER OSSA .....	244	KRAUSE SERRANODI .....	433/2
ISTEROMETRO, MARTIN .....	586	KERRISON PINZA TAGLIENTE NASALE .....	428	KRAUSE-VOSS SERRANODI .....	433/2
ISTEROMETRO, SIMS .....	586	KEVORKIAN CURETTA PER BIOPSIA .....	587	KRAYENBÜHL UNCINO PER NERVI .....	336
ITERSON DIVARICATORE TRACHEALE .....	477	KEVORKIAN PINZA PER BIOPSIA .....	589	KRISTELLER SPECILO VAGINALE .....	572
IVES-FANSLER ANOSCOPIO .....	562, 563	KEVORKIAN-PACIFIC PINZA PER BIOPSIA .....	592	KROENIG ABBASSALINGUA .....	451
IWANSON COMPASSO .....	624	KEY ELEVATORE .....	282	KRONECKER AGO PER LEGATURE .....	219
J		KEYES TREFINA CUTANEA .....	608	KUGLEN UNCINO .....	376
JACKSON BURROWS DIVARICATORE ADDOMINALE .....	189/2	KIELLAND FORCIPE .....	602	KUHNT RASCHIATOIO CORNEALE .....	373
JACKSON DIVARICATORE TRACHEALE .....	476	KIELLAND-LUIKART FORCIPE .....	603	KÜMMEL SPATOLA ADDOMINALE .....	144
JACKSON LARINGOSCOPIO PER OPERAZIONE .....	37	KILLIAN PER IRRIGAZIONE .....	433, 433/1	KÜMMEL SPATOLA ADDOMINALE E INTESTINALE .....	143/2
JACKSON PINZA PER AFFERRARE TENDINI DA PRESA .....	292	KILLIAN CANNULA PER IRRIGAZIONE .....	433, 433/1	KÜNTSCHER ALESATORE PER FEMORE .....	321
JACKSON PINZA PER POLIPI LARINGEI .....	471	KILLIAN FORBICE PER IL SETTO NASALE .....	471	KÜNTSCHER ALESATORE PER L'APERTURA DEL MIDOLLO .....	321
JACKSON SPECILO VAGINALE .....	573	KILLIAN SGORBIA .....	442/1	KÜNTSCHER ESTRATTATORE .....	322
JACOBS PINZA PER ABBASSARE IL COLLO DELL'UTERO .....	583	KILLIAN CLAUD SGORBIA PER SETTO .....	442/1	KÜNTSCHER IMPATTATORE FINALE .....	321
JACOBSON CURETTA TAGLIENTE .....	257	KILLNER FORBICI PER CHIRURGIA .....	54	L	
JACOBSON PINZA EMOSTATICA .....	105	KILNER PORT'AGHI .....	212	LA FORCE AGO PER CORPI ESTRANEI .....	374
JACOBSON PORT'AGHI .....	215	KILNER SUPERCUT FORBICI .....	72	LA FORCE COLTELLO ADENOIDE .....	450
JACOBSON SONTA BOTTUNUTA .....	335	KILNER UNCINO NASALE .....	447/1	LA GRANGE FORBICI GINGIVALI .....	69
JACOBSON UNCINO PER DURA MADRE .....	335	KILNER UNCINO PER LA PELLE .....	608	LABORDE DILATATORE TRACHEALE .....	476
JAEGER COLTELLO LANCEOLARE .....	372	KILNER-DOUGHTY APRIBOCCA .....	456	LACRIMAL CANNULA OCULISTICA .....	394
JAEGER PLACCA PER PALPEBRE .....	371	KIRBY-ARTHUR PINZA PER IRIDE .....	385	LAHEY DIVARICATORE .....	157
JAMESON PINZA PER STRABISMO .....	385	KIRK MARTELLO .....	270	LAHEY PINZA EMOSTATICA .....	119/2
JAMESON UNCINO PER IL STRABISMO .....	375	KIRSCHNER ARCO PER ESTENSIONE .....	312	LAHEY PINZA PER GOZZO .....	479
JANSEN CURETTA TAGLIENTE .....	257	KIRSCHNER DIVARICATORE ADDOMINALE .....	185	LAHEY UNCINO ACUTO .....	149
JANSEN DIVARICATORE .....	168	KIRSCHNER DIVARICATORE ADDOMINALE COMPLETO .....	187/1	LAMA DI RASOIO .....	45
JANSEN PINZA AURICOLARE .....	424	KIRSCHNER PERFORATORE A MANO .....	299	LAMA DI RICAMBIO .....	49
JANSEN PINZA SGORBIA .....	237	KIRSCHNER PERFORATORI FILIFORME .....	306, 307	LAMA DI RICAMBIO, STERILE .....	50
JARCHO PINZA PER ABBASSARE IL COLLO DELL'UTERO .....	583	KIRSCHNER SPECILLO DI GUIDA SCANALATO .....	221	LAMA PER OSTEOTOMI .....	266
JAVID PINZA PER CAROTIDE .....	511	KIRSCHNER US ARCO PER ESTENSIONE .....	312	LAMA PER SCALPELLI .....	266
JENNINGS APRIBOCCA .....	454	KIRSCHNER TELAIO PIEGABILE .....	187	LAMBERT PINZA PER CALAZIO .....	393
JENSEN CANNULA OCULISTICA .....	394	KIT PER AUTOPSIA IN ASTUCCIO DI LEGNO .....	269	LAMBERT-KAY PINZA PER ANASTOMOSI .....	505
JOBSON-HORNE PORTACOTONE .....	203	KLAPP DIVARICATORE .....	150	LAMBERT-LOWMAN PINZA PER OSSA .....	249
JOHNS-HOPKINS BULLDOG PINZA .....	104	KLEINERT-KUTZ PINZA PER AFFERRARE TENDINI .....	294	LAMBOTTE OSTEOTOMO .....	261
JOHNS-HOPKINS PINZA APPLICATRICE .....	104	KLEINERT-KUTZ PINZA SGORBIA .....	237	LAMBOTTE TENAGLIA PER OSSA .....	244
JOHNS-HOPKINS PINZA EMOSTATICA .....	120	KLEINERT-KUTZ UNCINO PER LA PELLE .....	149	LAME PER BISTURI, STERILI .....	42
JOHNSON PORT'AGHI .....	211	KLEINSASSER BRACCIO PORTALARINGOSCOPIO STERNALE .....	36	LAME PER BISTURI, STERILI .....	42
JONES PINZA FISSATELI .....	132	KLEINSASSER CANNULA DA INIEZIONE .....	36	LAMPADA FRONTALE, CLAR .....	22
JORGENSEN FORBICI PER DISSEZIONE .....	53	KLEINSASSER CANNULA D'ASPIRAZIONE .....	36	LANCASTER BLEFAROSTATO .....	371
JOSEPH (LEWIS) RASPA NASALE .....	443	KLEINSASSER PORTATORE DI LUCE FREDDA A FIBRE DI VETRO .....	36	LANDAU SPECILO VAGINALE .....	577
JOSEPH COLTELLO NASALE .....	434	KLEINSCHMIDT PINZA PER APPENDICE .....	544	LANDOLT PINZA DA PRESA PER TUMORI .....	341
JOSEPH ELEVATORE PER SETTO .....	437	KLINKENBERGH-LOTH .....	65/2	LANE CACCIAVITE .....	323, 324
JOSEPH FORBICI PER CHIRURGIA .....	54	KNAPP COLTELLO PER IRIDE .....	372	LANE ELEVATORE PER OSSA .....	290
JOSEPH PERIOTOTOMO .....	277	KNAPP CUCCHIAIO PER CATERATTA .....	378	LANE PIEGAPLACCHE .....	325
JOSEPH RASPA NASALE .....	443	KNAPP IRIS FORBICI .....	55	LANE PINZA CHIRURGICA .....	84
JOSEPH SEGA NASALE .....	446	KNAPP UNCINO DIVARICATORE .....	375	LANE PINZA FISSATELI .....	133
JOSEPH UNCINO PER LA PELLE .....	149	KNAPP-LUER PINZA PER TRACOMA .....	393	LANE PINZA PORTAPLACCHE .....	325
JUDD-ALLIS PINZA PER AFFERRARE INTESTINI .....	538	KNIGHT PINZA PER SETTO NASALE .....	425	LANE PINZA PORTAVITI .....	325
JUDD-MASSON DIVARICATORE VESCICALE .....	552	KNOWLES FORBICI PER BENDAGGI .....	70	LANE PINZA STOMACALE .....	547
JUERS MIKRO-PINZA AURICOLARE .....	414	KOCHER DIVARICATORE .....	155	LANE TENAGLIA PER OSSA .....	244
JURASZ PINZA PER POLIPI LARINGEI .....	471	KOCHER DIVARICATORE .....	159	LANE TRETOWAN ELEVATORE PER OSSA .....	290
K		KOCHER DIVARICATORE .....	160	LANG DISSETTORE PER SACCO LACRIMALE .....	378
KABIERSKE INSOFFIATORE PER POLVERE .....	405	KOCHER DIVARICATORE .....	163	LANGE INSERTO .....	472
KADER SPATOLA ADDOMINALE ED INTESTINALE .....	143/1	KOCHER DIVARICATORE .....	108	LANGE UNCINO PER LE PINNE NASALI .....	448
KALLMORGEN SPECILO VAGINALE .....	573	KOCHER PINZA EMOSTATICA .....	540	LANGE-HOHMANN ELEVATORE PER OSSA .....	286
KALT PINZA CAPSULARE .....	391	KOCHER PINZA INTESTINALE .....	479	LANGENBECK ANSA AURICOLARE .....	409
KALT, PORT'AGHI, .....	214	KOCHER SONTA PER GOZZO .....	552	LANGENBECK COLTELLO PER AMPUTAZIONE .....	44
KALT-ARRUGA PORT'AGHI .....	214	KOCHER SPATOLA VESCICALE .....	159	LANGENBECK COLTELLO PER CARTILAGINI .....	47
KANE PINZA OMBELICALE .....	605	KOENIG AGO .....	223	LANGENBECK DIVARICATORE .....	158
KANTROWITZ PINZA EMOSTATICA .....	119/1	KOERTE DIVARICATORE .....	162	LANGENBECK DIVARICATORE .....	159
KAYE FACE LIFT FORBICI .....	73			LANGENBECK PERIOTOTOMO .....	275
				LANGENBECK PORT'AGHI .....	213
				LANGENBECK SEGA PER DITA .....	296



LANGENBECK TENAGLIA PER OSSA .....	243	LOWMAN-HOGLUND PINZA PER OSSA .....	249	MATHIEU PINZA PER CORPI ESTRANEI .....	553/1
LANGENBECK-GREEN DIVARICATORE .....	153	LUBET-BARBON PINZA NASALE PER TAMPONI .....	424	MATHIEU PORT'AGHI .....	213
LARINGOSCOPIO MC INTOSH .....	29	LUC PINZA PER SETTO NASALE .....	426	MATHIEU SPECCHIO RETTALE .....	560
LARINGOSCOPIO MILLER .....	30	LUCAE AGO PER PARACENTESI .....	408	MATHIEU-OLSEN PORT'AGHI .....	212
LARINGOSCOPIO PER OPERAZIONE KLEINSASSER .....	35	LUCAE DIAPASON .....	404	MATSON PERIOSTOTOMO .....	279
LARINGOSCOPIO FOREGGER .....	29	LUCAE MARTELO .....	271	MATSON-ALEXANDER PERIOSTOTOMO .....	279
LARSEN PINZA PER AFFERRARE TENDINI .....	292	LUCAE PINZA AURICOLARE .....	410	MAUNDER APRIBOCCA DI LEGNO .....	459
LAWRENCE PINZA EMOSTATICA .....	119	LUCAE UNCINO .....	409	MAXI GRASPER PINZA PER BIOPSIA .....	593
LEBSCHÉ SCALPELLO PER STERNO .....	267	LUER CANNULA TRACHEALE .....	479	MAYFIELD PINZA SGORBIA .....	238
LEES PINZA PER BRONCHI .....	504	LUER DIVARICATORE .....	140	MAYO ABBASSALINGUA .....	451
LEGATORE EMORROIDALE, MC GIVNEY .....	568	LUER PINZA SGORBIA .....	236	MAYO CUCCHIAIO PER CALCOLI BILIARI .....	534
LEGATORE EMORROIDALE RUDD .....	568	LUER-KOERTE CUCCHIAIO PER CALCOLI BILIARI .....	533	MAYO FORBICI PER DISSEZIONE .....	52
LEGUE DIVARICATORE VESCICALE .....	553	LUIKART FORCIPE .....	603	MAYO PINZA .....	89
LEGUEU SPATOLA VESCICALE .....	552	LUIKART-BILL TRATTORE .....	604	MAYO SONDA PER CALCOLI BILIARI .....	534
LEKSELL(STILLE) PINZA SGORBIA .....	240	LUNDSGAARD SCLEROTOMO .....	373	MAYO SPILLONE PER STERILIZZAZIONE .....	227
LELAND-JONES PINZA VASCOLARE .....	494	LUNIATSCHEK TAMPONATORE .....	465	MAYO SUPERCUT FORBICI .....	71
LEMPERT CURETTA TAGLIENTE .....	256	M		MAYO-ADAMS DIVARICATORE .....	171
LEMPERT ELEVATORE .....	420	MAGIL PINZA PER INTRODUZIONE SONDE .....	28	MAYO-BLAKE PINZA PER CALCOLI BILIARI .....	531
LEMPERT PINZA SGORBIA .....	237	MAGLIA METALLICA PER ESTENSIONE .....	311	MAYO-COLLINS DIVARICATORE .....	141
LERCHE PINZA DA PRESA .....	83	MALTZ (COTTE) RASPA NASALE .....	444	MAYO-COLLINS DIVARICATORE-SET .....	141
LERICHE PINZA EMOSTATICA .....	111	MALTZ RASPA NASALE .....	443	MAYO-HABERISSER PINZA TORCIFILI .....	319
LERICHE SPATOLA ADDOMINALE E INTESTINALE .....	143/2	MANICI PER LAMA BISTURI .....	38	MAYO-HEGAR PORT'AGHI .....	209
LESINA .....	304	MANICI PER LAMA BISTURI .....	39	MAYON-GUYON PINZA EMOSTATICA .....	122
LESINA, PERTHES .....	304	MANICI PER LAMA BISTURI .....	39/1	MAYO-NOBLE FORBICI PER DISSEZIONE .....	52
LESTER PINZA FISSATRICE .....	389	MANICI PER LAMA BISTURI .....	39/2	MAYO-ROBSON PINZA INTESTINALE .....	541
LEVA PER CORPI ESTRANEI, BUCK .....	412	MANICI PER LAMA BISTURI .....	40	MAYO-STILLE FORBICI PER DISSEZIONE .....	52
LEVA PER CORPI ESTRANEI, QUIRE .....	412	MANICI PER LAMA BISTURI .....	41	MAYO-STILLE SUPERCUT FORBICI .....	71
LEVA PIEGAPLACCHE, LANE .....	325	MANICO .....	266	MC DONALD ELEVATORE .....	283
LEVINSON AGO PER CORPI ESTRANEI .....	374	MANICO .....	266	MC INDOE CESOIA PER OSSA .....	241
LEWIN TENAGLIA PER OSSA .....	246	MANICO .....	300	MC INTOSH LARINGOSCOPIO .....	29
LEXER BABY FORBICI PER DISSEZIONE .....	53	MANICO .....	300	MC INTOSH LARINGOSCOPIO SET .....	31
LEXER FORBICI PER DISSEZIONE .....	53	MANICO A BATTERIA PER LUCE CALDA .....	32	MC KENZIE PERFORATORE .....	299
LEXER MINI SGORBIA .....	263	MANICO A BATTERIA PER LUCE CALDA .....	34	MCCULLOUGH PINZA PER STRABISMO .....	385
LEXER OSTEOTOMO .....	263	MANICO A BATTERIA PER LUCE FREDDA .....	33	MC GEE MICRO-PINZA AURICOLARE .....	414
LEYLA SISTEMA DI FISSAGGIO .....	368, 368/1, 368/2, 368/3, 368/4	MANICO A T, HUDSON .....	300	MC GEE UNCINO .....	419
LICHTENBERG PORT'AGHI .....	213	MANICO CON ATTACCO RAPIDO .....	301	MCGIVNEY LEGATORE EMORROIDALE .....	568
LICHTWITZ CANNULA .....	433	MANICO D'ASPIRAZIONE WULLSTEIN .....	338	MCGIVNEY PINZA EMORROIDALE .....	568
LICHTWITZ TREQUARTO PER SENO MASCELLARE .....	204	MANICO PER STRUMENTI MICROLARINGEI .....	475	MCINDOE FORBICI PER CARTILAGINE .....	65/1
LIEBERMANN BLEFAROSTATO .....	371	MANICO UNIVERSALE, HUBER .....	472	MCINDOE PINZA CHIRURGICA .....	85
LIMA PER OSSA .....	294	MANO DI PIOMBO .....	250	MCINTYRE CANNULA OCULISTICA .....	394
LIMA PER OSSA .....	612/1	MARCATORE, CONNIN-AMSLER .....	380	MCIVOR APRIBOCCA .....	457
LIMETTA PER LE UNGHIE .....	610	MARQUARDT PINZA SGORBIA .....	239	MCKENTY ELEVATORE PER SETTO .....	437
LISTER FORBICI PER BENDAGGI .....	69/1	MARSHK PINZA PER TONSILLE .....	468	MCKENZIE PINZA POSA CLIPS .....	326
LISTER SUPERCUT FORBICI .....	72	MARTEL PINZA DA PRESA .....	110	MCCLEAN FORCIPE .....	603
LISTER(SINUS) TUPFERZA .....	137	MARTELO DI PERCUSSIONE, BABINSKY .....	24	MCCLEAN-LUIKART FORCIPE .....	603
LISTER-BURCH BLEFAROSTATO .....	370	MARTELO DI PERCUSSIONE, BERLINER .....	24	MCCLEAN-TUCKER-LUIKART FORCIPE .....	603
LISTON CESOIA PER OSSA .....	241	MARTELO DI PERCUSSIONE, BUCK .....	24	MCPHERSON PINZA PER FILO .....	392
LISTON COLTELLO PER AMPUTAZIONE .....	44	MARTELO DI PERCUSSIONE, TAYLOR .....	24	MEAD MARTELO .....	271
LITTAUER FORBICI PER LEGATURE .....	66	MARTELO DI PERCUSSIONE, TROEMNER .....	24	MEAD PINZA SGORBIA .....	235
LITTAUER PINZA AURICOLARE .....	411	MARTELO IN PLASTICA .....	271	MEEKER PINZA EMOSTATICA .....	119
LITTAUER PINZA DEPIILATORIA .....	395	MARTELO, BERGMANN .....	272	MEHDORN CLIPS PER VASI .....	362
LITTAUER PINZA PER POLIPI .....	425	MARTELO, COLLIN .....	270	MEHDORN PINZA POSA CLIPS .....	362
LITTLE DIVARICATORE .....	157	MARTELO, COTTLE .....	273	MELLINGER BLEFAROSTATO .....	370
LITTLE IRIS FORBICI .....	55	MARTELO, GERZOG .....	270	MELLINGER-AXENFELD BLEFAROSTATO .....	370
LITTLEWOOD PINZA PER AFFERRARE INTESTINI .....	538	MARTELO, HAJEK .....	273	MENGHINI AGO PER BIOPSIA .....	206
LOCKHART-MUMMERY SPECILLO PER FISTOLE .....	200	MARTELO, HEATH .....	273	MERCEDES DIVARICATORE PER TORACE .....	489
LOCKLIN FORBICE GINGIVALI .....	69	MARTELO, KIRK .....	270	MERIAM PINZA DENTALE .....	93
LOCKWOOD-ALLIS PINZA PER AFFERRARE INTESTINI .....	538	MARTELO, LUCAE .....	271	METZENBAUM FINO TC FORBICI PER DISSEZIONE .....	53/1
LONDON-COLLEGE PINZA DENTALE .....	93	MARTELO, MEAD .....	271	METZENBAUM FORBICI PER CHIRURGIA .....	54
LOPEZ-REINKE DISSETTORE PER TONSILLE .....	465	MARTELO, OMBREDANNE .....	273	METZENBAUM FORBICI PER DISSEZIONE .....	53/1
LORENZ FORBICI PER BENDAGGI .....	70	MARTELO, PARTSCH .....	271	METZENBAUM PORT'AGHI .....	211
LORNA PINZA FISSATELI .....	133	MARTELO, QUISLING .....	271	METZENBAUM SUPERCUT FORBICI .....	71
LOUTE STRUMENTO TENDIFILI .....	315	MARTELO, WILLIGER .....	271	METZENBAUM TC FORBICI PER DISSEZIONE .....	53/1
LOVE DIVARICATORE .....	465	MARTIN DIVARICATORE .....	175/1	MEYERDING DIVARICATORE .....	157
LOVE UNCINO PER NERVI .....	329/2	MARTIN FORBICI PER CARTILAGINE .....	65/1	MEYERDING DIVARICATORE .....	177
LOVE UNCINO PER RADICI DEI NERVI .....	330	MARTIN ISTEROMETRO .....	586	MEYERDING DIVARICATORE .....	180
LOVE-GRUENWALD PINZA TAGLIENTE PER LAMINECTOMIA .....	340	MARTIN PELVIMETRO .....	605	MEYHOEFER CURETTA DA CALAZIO .....	377
LOVELACE PINZA EMOSTATICA .....	109	MARTIN TENAGLIA PER OSSA .....	246	MICHEL AGRAFES .....	224
LOVELACE PINZA PER AFFERRARE IL POLMONE .....	490	MARTINI CURETTA TAGLIENTE .....	257	MICHEL PINZA PER AGRAFES .....	224
LOWER PINZA EMOSTATICA .....	120	MASING-NEIVERT UNCINO NASALE .....	447/1	MICHEL SPECCHIO LARINGEO .....	423
LOWMAN PINZA PER OSSA .....	249	MASSON PORT'AGHI .....	210	MICRO FORBICI .....	76
		MASTIN PINZA MUSCOLARE .....	479	MICRO FORBICI .....	77
		MATHIEU DIVARICATORE .....	141	MICRO FORBICI .....	78



MICRO FORBICI AURICOLARI, BELLUCCI.....	413	MUSEUM PINZA PER ABBASSARE IL COLLO		O'SULLIVAN-O'CONNOR SPECOLO VAGINALE.....	576
MICRO FORBICI AURICOLARI, SHEA.....	413	DELL'UTERO.....	583	OTIS URETROTOMO.....	553
MICRO FORBICI, GOMEL.....	80	MYLES PINZA NASALE.....	427	OVERHOLT PINZA EMOSTATICA.....	114
MICRO FORBICI, HEPP-SCHEIDEL.....	78			OVERHOLT-BABY PINZA EMOSTATICA.....	114
MICRO FORBICINE, BELLUCCI.....	417	<b>N</b>		OVERHOLT-GEISENDOERFER PINZA EMOSTATICA.....	114
MICRO FRIEDMANN PINZA SGORBIA.....	234	NABATOFF SET PER VARICI IN SCATOLA DI METALLO ...	201	OVERHOLT-MIXTER PINZA EMOSTATICA.....	115
MICRO PINZA AURICOLARE.....	415	NAEGELE FORCIPE.....	602		
MICRO PINZA AURICOLARE A CUCCHIAIO		NAGER AGO PER TONSILLE.....	466	<b>P</b>	
WULLSTEIN.....	416	NAGER DIVARICATORE.....	465	PADELLA.....	621
MICRO-HARTMANN PINZA EMOSTATICA.....	104	NEFF COLTELLO PER MENISCO.....	292	PARK BLEFAROSTATO.....	371
MICROPINZA CHIRURGICA, GOMEL.....	96	NEGUS PINZA PER TONSILLE.....	467	PARKER DIVARICATORE.....	139
MICROVASCULAR PORT'AGHI.....	210	NEGUS SUPPORTO PER PETTO.....	459	PARTSCH MARTELLO.....	271
MIDDELDORPF DIVARICATORE.....	160	NEIVERT PORT'AGHI.....	208	PARTSCH SCALPELLO.....	259
MIDDLETON-JANSEN PINZA PER SETTO NASALE.....	430	NEIVERT-ANDERSON OSTEOTOMO NASALE.....	442	PARTSCH SGORBIA.....	259
MIKRO COLTELLO FALCATO.....	475	NELATON SPECILLO SCANALATO.....	199	PASSOW PESTELLO DA TAMPONARE.....	260
MIKRO SEPERATORE.....	475	NELSON AGO PER LEGATURE.....	219	PATON DISETTORE CORNEALE.....	373
MIKRO UNCINO.....	475	NELSON STANDARD TREQUARTO.....	204	PAUFIQUE COLTELLO PER CHERATOPLASTICA.....	373
MIKRO-PINZA AURICOLARE.....	413	NELSON TREQUARTO.....	205	PAUFIQUE PINZA PER FILO.....	392
MIKRO-PINZA AURICOLARE, COS.....	414	NEONATAL PINZA VASCOLARE CASTANEDA.....	527	PAYR SCHIACCIATORE PER L'INTESTINO E LO	
MIKRO-PINZA AURICOLARE, DIETER.....	414	NEWS DIVARICATORE TRACHEALE.....	477	STOMACO.....	548
MIKRO-PINZA AURICOLARE, GREVEN.....	414	NISSEN PINZA EMOSTATICA.....	113	PAYR SPECILLO DI GUIDA SCANALATO.....	221
MIKRO-PINZA AURICOLARE, HAUGH.....	414	NORFOLK-NORWICH DIVARICATORE.....	172	PEAN PINZA DA PRESA.....	110
MIKRO-PINZA AURICOLARE, JUERS.....	414	NORTHBENT FORBICI PER LEGATURE.....	66	PEAN PINZA EMOSTATICA.....	108
MIKRO-PINZA AURICOLARE, MCGEE.....	414	NOTO PINZA PER POLIPI UTERINI.....	585	PECK-JOSEPH FACE LIFT FORBICI.....	74
MIKULICZ DIVARICATORE.....	163	NOVA, SFIGMOMANOMETRO.....	6.7	PECK-JOSEPH FACE LIFT FORBICI.....	74
MIKULICZ PINZA INTESTINALE.....	543	NOVAK CURETTA PER BIOPSIA.....	587	PEDERSON SPECOLO VAGINALE.....	570
MIKULICZ PINZA PERITONEALE.....	123	NOYES FORBICI OCULISTICHE.....	75	PEENFIELD DISSETTORE.....	333
MIKULICZ-BABY PINZA PERITONEALE.....	123	NOYES PINZA PER POLIPI.....	425	PEERS PINZA FISSATELI.....	132
MILLER LARINGOSCOPIO.....	30	<b>O</b>		PEET PINZA PER SCHEGGE.....	92
MILLER RASPA NASALE.....	444	OBWEGESER AGO DI INTRODUZIONE.....	463	PEET RASPA NASALE.....	446
MILLIGAN DURA DISSETTORE.....	332	OBWEGESER AGO DI INTRODUZIONE.....	463/3	PELKMANN PINZA PER MEDICATURA.....	137
MILLIN DIVARICATORE VESCICALE.....	552	OBWEGESER DIVARICATORE.....	460, 461	PELVIMETRO, COLLIER.....	605
MILLIN DIVARICATORE VESCICALE.....	553	OBWEGESER OSTEOTOMO A LAMA.....	464/1	PELVIMETRO, COLLIN.....	605
MILLIN PINZA CAPSULARE DA PRESA.....	551	OBWEGESER PERIOSTOTOMO.....	461, 462, 463	PELVIMETRO, MARTIN.....	605
MILLIN PINZA DA PRESA PER LA PROSTATA.....	551	OCCHIALI NISTAGMO FRENZEL.....	20	PENNINGTON ELEVATORE PER SETTO.....	438
MINI MANICO CON ATTACCO RAPIDO.....	301	OCHSNER TREQUARTO.....	205	PENNINGTON PINZA EMOSTATICA.....	109
MINI-LAMBOTTE OSTEOTOMO.....	262	O'CONNOR UNCINO PER IRIDE.....	375	PERCY RETRATTORE.....	296
MINIMUS II, SFIGMOMANOMETRO.....	11	OEHLER PINZA CHIRURGICA.....	81/1	PERFORATORE A MANO, BUNELL.....	299
MINIMUS III, SFIGMOMANOMETRO.....	12	OLDBERG PINZA TAGLIENTE PER LAMINECTOMIA.....	341	PERFORATORE A MANO, HUDSON KPLT.....	299
MIXTER PINZA CURVA AD "S".....	116	OLIO PER STRUMENTI INSTRU CARE.....	634	PERFORATORE A MANO, KIRSCHNER.....	299
MIXTER PINZA PER CALCOLI BILIARI.....	531	OLIVA NASALE POLITZER.....	406	PERFORATORE A MANO, MOORE.....	298
MIXTER-BABY PINZA EMOSTATICA.....	119/1	OLIVECRONA DURA DISSETTORE.....	332	PERFORATORE A MANO, RALK.....	300
MIXTER-O'SHAUGNESSY PINZA EMOSTATICA.....	119/2	OLIVECRONA PINZA SGORBIA.....	237	PERFORATORE A MANO, STILLE.....	298
MOD. BONN PINZA PER IRIDE.....	387	OLIVECRONA PINZA SGORBIA.....	237	PERFORATORE A MANO, STILLE-SHERMAN.....	298
MOD. TÜBINGEN PINZA PER IRIDE.....	387	OLIVECRONA SEGA IN FILO D'ACCIAIO.....	332	PERFORATORE ELICOIDALE.....	302
MOD.MÜNCHEN CURETTA PER BIOPSIA.....	587	OLIVECRONA SPATOLA CEREBRALE.....	336	PERFORATORE INTRAMIDOLLARE.....	322
MOD.VIENNA SPECOLO NASALE.....	421	OLIVECRONA-TOENNIS (SCOVILLE).....	326	PERFORATORE, CRUTCHFIELD.....	327
MODELLATORE PER CHIODI, BENDER.....	322	OLIVECRONA-TOENNIS PINZA POSA CLIPS.....	326	PERFORATORE, CUSHING.....	299
MODELLO RUSSO, PINZA DA PRESA.....	85	OLLIER DIVARICATORE.....	162	PERFORATORE, ERRICO.....	299
MODELLO STRASSBURG PINZA CHIRURGICA.....	89	OLSEN-HEGAR PORT'AGHI.....	212	PERFORATORE, MC KENZIE.....	299
MOELTGEN GONIOMETRO.....	25	OMBREDANNE MARTELLO.....	273	PERFORATORE, SMELLIE.....	607
MOGEN STRUMENTO PER CIRCONCISIONE.....	556	OSTEOTOME, COTTLE.....	440	PERFORATORI FILIFORME KIRSCHNER.....	306, 307
MOLLISON DIVARICATORE.....	171	OSTEOTOMI.....	259	PERIOSTOTOMO.....	279
MOLT PERIOSTOTOMO.....	276	OSTEOTOMI.....	464	PERIOSTOTOMO MOLT.....	276
MONOPOLAR ELEKTRODEN ANSAN.....	628, 629	OSTEOTOMI EPKER.....	464/2	PERIOSTOTOMO SELDIN.....	277
MOOR CUCCHIAIO PER CALCOLI BILIARI.....	532	OSTEOTOMO A LAMA OBWEGESER.....	464/1	PERIOSTOTOMO, ADSON.....	282
MOORE PERFORATORE A MANO.....	298	OSTEOTOMO LEXER.....	263	PERIOSTOTOMO, ALEXANDER.....	276
MOORFIELD PINZA PER SUTURA.....	392	OSTEOTOMO MINI-LAMBOTTE.....	262	PERIOSTOTOMO, COBB.....	280
MORGAN PROCTOSCOPIO.....	565	OSTEOTOMO NASALE NEIVERT-ANDERSON.....	442	PERIOSTOTOMO, DINGMANN.....	463
MORITZ-SCHMIDT ABBASSALINGUA.....	452	OSTEOTOMO PER SETTO, COTTLE.....	440	PERIOSTOTOMO, DOYEN.....	278
MORRIS DIVARICATORE.....	164	OSTEOTOMO PER SETTO, FOMON.....	441	PERIOSTOTOMO, FARABEUF.....	274
MORRIS-DEBAKEY PINZA AORTA.....	506	OSTEOTOMO PER SETTO, SHEEHAN.....	441	PERIOSTOTOMO, FARABEUF-COLLIN.....	274
MORSE DIVARICATORE COSTALE.....	484	OSTEOTOMO, HIBBS.....	265	PERIOSTOTOMO, FOMON.....	277
MORSE-FAVALORO DIVARICATORE COSTALE.....	484	OSTEOTOMO, LAMBOTTE.....	261	PERIOSTOTOMO, JOSEPH.....	277
MORSETTO PER SISTEMA BRACCIO.....	189	OSTEOTOMO, SMITH-PETERSEN.....	261	PERIOSTOTOMO, KOENIG.....	276
MOYNIHAN PINZA EMOSTATICA.....	120	OSTEOTOMO, STILLE.....	260	PERIOSTOTOMO, LAMBOTTE.....	274
MOYNIHAN PINZA FISSATELI.....	133	OSTEOTOMO PER SETTO RUBIN.....	440	PERIOSTOTOMO, LANGENBECK.....	275
MOYNIHAN SONDA PER CALCOLI BILIARI.....	532	OSTROEM PINZA TAGLIENTE PER SETTO NASALE.....	430	PERIOSTOTOMO, MATSON.....	279
MUELLER BLEFAROSTATO.....	371	OSTROEM PINZA TAGLIENTE PER SETTO NASALE.....	430	PERIOSTOTOMO, MATSON-ALEXANDER.....	279
MÜLLER CLIPS PER VASI.....	364, 365	O'SULLIVAN-O'CONNOR DIVARICATORE		PERIOSTOTOMO, OBWEGESER.....	461, 462, 463
MURDOCK BLEFAROSTATO.....	370	ADDOMINALE.....	181	PERIOSTOTOMO, SEMB.....	278
MURPHY DIVARICATORE.....	156	O'SULLIVAN-O'CONNOR DIVARICATORE		PERIOSTOTOMO, WILLIGER.....	276
MURPHY-LANE ELEVATORE.....	283	ADDOMINALE.....	181	PERKINS DIVARICATORE.....	168



PERTHES LESINA.....	304	PINZA CHIRURGICA, ADSON-BROWN .....	82	PINZA EMOSTATICA, KELLY-RANKIN .....	106
PESTALOZZA CURETTA PER ABORTO .....	606	PINZA CHIRURGICA, BONNEY .....	88	PINZA EMOSTATICA, LAHEY .....	119/2
PESTELLO DA TAMPONARE, PASSOW .....	260	PINZA CHIRURGICA, BROPHY .....	84	PINZA EMOSTATICA, LAWRENCE .....	119
PETZ APPARECCHIATURA DI SUTURA .....		PINZA CHIRURGICA, CUSHING .....	83	PINZA EMOSTATICA, LERICHE .....	111
GASTRO-INTESTINALE .....	549	PINZA CHIRURGICA, FERRIS-SMITH .....	84	PINZA EMOSTATICA, LOVELACE .....	109
PHANEUF PINZA PERITONEALE .....	123	PINZA CHIRURGICA, GILLIES .....	86	PINZA EMOSTATICA, LOWER .....	120
PIERCE ELEVATORE PER SETTO .....	438	PINZA CHIRURGICA, LANE .....	84	PINZA EMOSTATICA, MAYO-GUYON .....	122
PIERCE TREQUARTO PER SENO MASCELLARE .....	204	PINZA CHIRURGICA, MCINDOE .....	85	PINZA EMOSTATICA, MEEKER .....	119
PIFFARD CURETTA PER LUPUS .....	608	PINZA CHIRURGICA, MOD.USA .....	81/1	PINZA EMOSTATICA, MICRO-HARTMANN .....	104
PILLING PINZA APPLICATORE CLIPS SMAL .....	524, 525	PINZA CHIRURGICA, OEHLER TC .....	81/1	PINZA EMOSTATICA, MIXTER .....	119/1
PINARD STETOSCOPIO .....	23	PINZA CHIRURGICA, SEMKEN .....	86	PINZA EMOSTATICA, MIXTER-BABY .....	119/1
PINZA PER CORPI ESTRANEI, HARTMANN .....	412	PINZA CHIRURGICA, STILLE .....	81/1	PINZA EMOSTATICA, MOYNIHAN .....	120
PINZA PER CORPI ESTRANEI, .....		PINZA CHIRURGICA, TAYLOR .....	87	PINZA EMOSTATICA, O'SHAUGNESSY .....	119/2
HARTMANN-HOFFMANN .....	412	PINZA COPERCHIO REDA .....	615	PINZA EMOSTATICA, PENNINGTON .....	109
PINZA PER CORPI ESTRANEI, .....		PINZA CURVA AD "S" MIXTER.....	116	PINZA EMOSTATICA, PROVIDENCE-HOSPITAL .....	106
HARTMANN-WULLSTEIN .....	412	PINZA DA PRESA .....	316,317	PINZA EMOSTATICA, ROBERTS .....	117
PINZA VASCOLARE, WANGENSTEEN .....	89	PINZA DA PRESA COTTLE .....	410	PINZA EMOSTATICA, ROCHESTER-CARMALT .....	109
PINZA AD ASTA TUBOLARE PER MICROCHIRURGIA .....	474	PINZA DA PRESA PER FILI KIRSCHNER .....	305	PINZA EMOSTATICA, ROCHESTER-OCHSNER .....	108
PINZA ANATOMICA STANDARD .....	81	PINZA DA PRESA PER LA PROSTATI, MILLIN .....	551	PINZA EMOSTATICA, ROCHESTER-PEAN .....	108
PINZA ANATOMICA, ADSON .....	82	PINZA DA PRESA PER TONSILLE ABRAHAM .....	468	PINZA EMOSTATICA, RUMEL .....	117
PINZA ANATOMICA, ADSON MICRO .....	82	PINZA DA PRESA PER TUMORI, LANDOLT .....	341	PINZA EMOSTATICA, SAROT .....	118
PINZA ANATOMICA, BONNEY .....	88	PINZA DA PRESA, COLLIN-DUVAL .....	85	PINZA EMOSTATICA, SPENCER-WELLS .....	109
PINZA ANATOMICA, BONNEY .....	88	PINZA DA PRESA, DURANTE .....	88	PINZA EMOSTATICA, STILLE .....	122
PINZA ANATOMICA, BROPHY .....	84	PINZA DA PRESA, DUVAL .....	85	PINZA EMOSTATICA, TOENNIS .....	117
PINZA ANATOMICA, CUSHING .....	83	PINZA DA PRESA, GRAFFE .....	83	PINZA EMOSTATICA, ZENKER .....	118
PINZA ANATOMICA, GERALD .....	86	PINZA DA PRESA, LERCHE .....	83	PINZA EMOSTATICA, OVERHOLT-BABY .....	114
PINZA ANATOMICA, MCINDOE .....	85	PINZA DA PRESA, MARTEL .....	110	PINZA EMOSTATICA, OVERHOLT-GEISSDÖRFFER .....	114
PINZA ANATOMICA, MOD.USA .....	81	PINZA DA PRESA, MODELLO RUSSO .....	85	PINZA EMOSTATICA, OVERHOLT-MIXTER .....	115
PINZA ANATOMICA, POTTS-SMITH .....	81	PINZA DA PRESA, PEAN .....	110	PINZA FISSATELI .....	133
PINZA ANATOMICA, SEMKEN .....	86	PINZA DA PRESA, PRATT .....	110	PINZA FISSATELI BALL AND SOCKET .....	133
PINZA ANATOMICA, STILLE .....	81	PINZA DA PRESA, WILLET MARTEL .....	110	PINZA FISSATELI, BACKHAUS .....	132
PINZA ANATOMICA, TAYLOR .....	87	PINZA DENTALE LONDON-COLLEGE .....	93	PINZA FISSATELI, BERNHARD .....	133
PINZA ANATOMICA, TC .....	81	PINZA DENTALE MERIAM .....	93	PINZA FISSATELI, DOYEN .....	133
PINZA ANEURISMA DEBAKEY-BAHNSON .....	506	PINZA DEPILATORIA BEER .....	395	PINZA FISSATELI, JONES .....	132
PINZA AORTA DIETRICH .....	510	PINZA DEPILATORIA, BARRAQUER .....	395	PINZA FISSATELI, LANE .....	133
PINZA AORTA MORRIS-DEBAKEY .....	506	PINZA DEPILATORIA, DOUGLAS .....	395	PINZA FISSATELI, LORNA .....	133
PINZA ATRAUMATICA BULLDOG, DE BAKEY .....	100	PINZA DEPILATORIA, GRADLE .....	395	PINZA FISSATELI, MOYNIHAN .....	133
PINZA ATRAUMATICA BULLDOG, GLOVER .....	100	PINZA DEPILATORIA, LITTAUER .....	395	PINZA FISSATELI, PEERS .....	132
PINZA ATRAUMATICA IN TITANIO, DEBAKEY .....	99	PINZA DEPILATORIA, REDA .....	395	PINZA FISSATELI, ROEDER .....	132
PINZA ATRAUMATICA PER NEONATI E BAMBINI .....	523	PINZA EMORROIDALE FERGUSSON .....	109	PINZA FISSATELI, SCHAEDEL .....	132
PINZA ATRAUMATICA TC DEBAKEY .....	99	PINZA EMORROIDALE, MCGIVNEY .....	568	PINZA FISSATELI, TOHOKU .....	132
PINZA AURICOLARE, HARTMANN .....	411	PINZA EMOSTATICA BIRKETT .....	116	PINZA FISSATRICE, BARRAQUER .....	390
PINZA AURICOLARE, HEYMANN-KNIGHT .....	425	PINZA EMOSTATICA BRIDGE .....	106	PINZA FISSATRICE, CASTROVIEJO .....	390
PINZA AURICOLARE, JANSEN .....	424	PINZA EMOSTATICA COLLER-CRILE .....	106	PINZA FISSATRICE, ELSCHNIG .....	389
PINZA AURICOLARE, LITTAUER .....	411	PINZA EMOSTATICA DEBAKEY-MOSQUITO .....	509	PINZA FISSATRICE, GRAEFE .....	389
PINZA AURICOLARE, LUCAE .....	410	PINZA EMOSTATICA DEBAKEY-PEAN .....	513	PINZA FISSATRICE, GREEN .....	390
PINZA AURICOLARE, TILLEY .....	411	PINZA EMOSTATICA DEBAKEY-RANKIN .....	512	PINZA FISSATRICE, LESTER .....	389
PINZA AURICOLARE, TROELTSCH .....	424	PINZA EMOSTATICA FUCHSIG .....	113	PINZA INTESTINALE BRUNNER .....	543
PINZA AURICOLARE, WILDE (TROELTSCH) .....	410	PINZA EMOSTATICA KANTROWITZ .....	119/1	PINZA INTESTINALE PER BIOPSIA, TURREL .....	567
PINZA AURICOLA, HARKEN .....	503	PINZA EMOSTATICA KOCHER .....	108	PINZA INTESTINALE PER BIOPSIA, YEOMAN .....	566, 567
PINZA BIPOLARE .....	630, 631	PINZA EMOSTATICA NISSEN .....	113	PINZA INTESTINALE SCUDDER .....	541
PINZA BIPOLARE A BAIONETTA .....	631, 632	PINZA EMOSTATICA OVERHOLT .....	114	PINZA INTESTINALE, BABY-KOCHER .....	540
PINZA CAPSULARE DA PRESA, MILLIN .....	551	PINZA EMOSTATICA PEAN .....	108	PINZA INTESTINALE, DOYEN .....	540
PINZA CAPSULARE, ARRUGA .....	391	PINZA EMOSTATICA WIKSTROEM .....	117	PINZA INTESTINALE, FEHLAND .....	542
PINZA CAPSULARE, CASTROVIEJO .....	391	PINZA EMOSTATICA, ADSON .....	112	PINZA INTESTINALE, KOCHER .....	540
PINZA CAPSULARE, ELSCHNIG .....	391	PINZA EMOSTATICA, ADSON-BABY .....	113	PINZA INTESTINALE, MAYO-ROBSON .....	541
PINZA CAPSULARE, FUCHS .....	391	PINZA EMOSTATICA, BAINBRIDGE .....	119/2	PINZA INTESTINALE, MIKULICZ .....	543
PINZA CAPSULARE, GILL-ARRUGA .....	390	PINZA EMOSTATICA, BENGOLEA .....	112	PINZA INTESTINALE, RESANO .....	542
PINZA CAPSULARE, HESS .....	391	PINZA EMOSTATICA, CRAFOORD .....	118	PINZA INTESTINALE, STONE-WATT .....	545
PINZA CAPSULARE, KALT .....	391	PINZA EMOSTATICA, CRAFOORD-SELLORS .....	119	PINZA MAYO .....	89
PINZA CAPSULARE, SCHWEIGGER .....	391	PINZA EMOSTATICA, CRILE .....	107	PINZA MODELLO STRASSBURG .....	89
PINZA CAPSULARE, TERSON .....	391	PINZA EMOSTATICA, CRILE-RANKIN .....	107	PINZA MUSCOLARE, BERKE .....	389
PINZA CARDIOVASCOLARE ATRAUMATICA .....	526	PINZA EMOSTATICA, DANDY .....	109	PINZA MUSCOLARE, MASTIN .....	479
PINZA CARDIOVASCOLARE ATRAUMATICA COOLEY .....	518, 519, 522	PINZA EMOSTATICA, DESJARDINS .....	121	PINZA MUSCOLARE, PRINCE .....	387
PINZA CARDIOVASCOLARE ATRAUMATICA DERRA .....	515	PINZA EMOSTATICA, GEMINI .....	115	PINZA NASALE GRAIG .....	426
PINZA CARDIOVASCOLARE ATRAUMATICA GREGORY .....	517	PINZA EMOSTATICA, GRAY .....	121	PINZA NASALE PER TAMPONI LUBET-BARBON .....	424
PINZA CHIRURGICA GERALD .....	87	PINZA EMOSTATICA, GUYON .....	122	PINZA NASALE PER TAMPONI WESTMACOTT .....	424
PINZA CHIRURGICA POTTS SMITH .....	81	PINZA EMOSTATICA, HALSTED-MOSQUITO .....	105	PINZA NASALE WEIL-BLAKESLEY .....	426
PINZA CHIRURGICA STANDARD .....	81/1	PINZA EMOSTATICA, HARTMANN .....	104	PINZA NASALE, CAPLAN .....	428
PINZA CHIRURGICA WAUGH .....	83	PINZA EMOSTATICA, HEISS .....	112	PINZA NASALE, HARTMANN .....	427
PINZA CHIRURGICA, ADSON .....	82	PINZA EMOSTATICA, JACOBSON .....	105	PINZA NASALE, MYLES .....	427
PINZA CHIRURGICA, ADSON MICRO .....	82	PINZA EMOSTATICA, JOHNS-HOPKINS .....	120	PINZA NASALE, SCHMEDEN .....	427
		PINZA EMOSTATICA, KELLY .....	106	PINZA NASALE, TAKAHASHI .....	427



PINZA NASALE, WATSON-WILLIAMS.....	428	PINZA PER AGRAFES, RICHTER-HEATH .....	224	PINZA PER IRIDE, GRAEFEE.....	382
PINZA NASALE, STRUYCKEN.....	427	PINZA PER ANASTOMOSI DEL RETTO, HAYES .....	545	PINZA PER IRIDE, HESS .....	384
PINZA OMBELICALE, COLLIN.....	605	PINZA PER ANASTOMOSI, BECK .....	516	PINZA PER IRIDE, KIRBY-ARTHUR.....	385
PINZA OMBELICALE, KANE.....	605	PINZA PER ANASTOMOSI, BECK .....	520	PINZA PER IRIDE, MOD. BONN.....	387
PINZA PER ABBASSARE IL COLLO DELL'UTERO CZERNY .....	584	PINZA PER ANASTOMOSI, COOLEY-DERRA .....	519	PINZA PER IRIDE, MOD. TUEBINGEN .....	387
PINZA PER ABBASSARE IL COLLO DELL'UTERO SCHRÖDER .....	583, 584	PINZA PER ANASTOMOSI, DE MARTEL-WOLFSON .....	546	PINZA PER IRIDE, TROUTMAN.....	389
PINZA PER ABBASSARE IL COLLO DELL'UTERO, BARRET.....	582	PINZA PER ANASTOMOSI, DEBAKEY .....	505	PINZA PER IRIDE, STEVENS .....	383
PINZA PER ABBASSARE IL COLLO DELL'UTERO, BRAUN .....	582	PINZA PER ANASTOMOSI, LAMBERT-KAY .....	505	PINZA PER ISTERECTOMIA SEGOND.....	125
PINZA PER ABBASSARE IL COLLO DELL'UTERO, DUPLAY .....	582	PINZA PER AORTA PEDIATRICA, SUBRAMANIAN-MINIATURE .....	521	PINZA PER ISTERECTOMIA SEGOND-LANDAU .....	125
PINZA PER ABBASSARE IL COLLO DELL'UTERO, HULKA.....	583	PINZA PER AORTA, WEBER.....	501	PINZA PER ISTERECTOMIA, HEANEY.....	126
PINZA PER ABBASSARE IL COLLO DELL'UTERO, IOWA .....	584	PINZA PER APPENDICE, ALLEN.....	544	PINZA PER ISTERECTOMIA, HEANY-BALLENTINE.....	127
PINZA PER ABBASSARE IL COLLO DELL'UTERO, JACOBS .....	583	PINZA PER APPENDICE, KLEINSCHMIDT.....	544	PINZA PER ISTERECTOMIA, ROGERS .....	127
PINZA PER ABBASSARE IL COLLO DELL'UTERO, JARCHO.....	583	PINZA PER BIOPSIA BABY BURKE .....	590	PINZA PER ISTERECTOMIA, GROSS-MAIER.....	124
PINZA PER ABBASSARE IL COLLO DELL'UTERO, MUSEUX.....	583	PINZA PER BIOPSIA BABY TISCHLER .....	592	PINZA PER ISTERECTOMIA, WERTHEIM .....	128
PINZA PER ABBASSARE IL COLLO DELL'UTERO, PRATT .....	584	PINZA PER BIOPSIA SCHUMACHER .....	588, 589	PINZA PER LACERAZIONE UNGHIE, RADOLF .....	297
PINZA PER ABBASSARE IL COLLO DELL'UTERO, SCHROEDER .....	583, 584	PINZA PER BIOPSIA TOWNSEND.....	591	PINZA PER MEDICATURA.....	135
PINZA PER ABBASSARE IL COLLO DELL'UTERO, SCHROEDER (POZZI).....	582	PINZA PER BIOPSIA, ALEXANDER.....	589	PINZA PER MEDICATURA, BRYANT .....	137
PINZA PER ABBASSARE IL COLLO DELL'UTERO, SKENE.....	582	PINZA PER BIOPSIA, BURKE.....	590	PINZA PER MEDICATURA, CHERON.....	137
PINZA PER ABBASSARE IL COLLO DELL'UTERO, TEALE.....	583	PINZA PER BIOPSIA, BURKE.....	590	PINZA PER MEDICATURA, COLLIN.....	137
PINZA PER ABBASSARE IL COLLO DELL'UTERO, STAUDE-MOORE.....	582	PINZA PER BIOPSIA, EPPENDORFER.....	590	PINZA PER MEDICATURA, DUPLAY .....	134
PINZA PER ABBASSARE IL COLLO DELL'UTERO, SAENGER .....	606	PINZA PER BIOPSIA, FAURE .....	588	PINZA PER MEDICATURA, FOERSTER .....	136
PINZA PER ABBASSARE IL COLLO DELL'UTERO, WINTER.....	606	PINZA PER BIOPSIA, FAVRE.....	592	PINZA PER MEDICATURA, GROSS-MAIER.....	134
PINZA PER AFFERRARE IL POLMONE, LOVELACE.....	490	PINZA PER BIOPSIA, KEVORKIAN.....	589	PINZA PER MEDICATURA, LISTER (SINUS).....	137
PINZA PER AFFERRARE INTESTINI DOYEN-BABY.....	540	PINZA PER BIOPSIA, KEVORKIAN.....	591	PINZA PER MEDICATURA, PELKMANN.....	137
PINZA PER AFFERRARE INTESTINI LOCKWOOD-ALLIS .....	538	PINZA PER BIOPSIA, MAXI GRASPER .....	593	PINZA PER MEDICATURA, RAMPLEY .....	136
PINZA PER AFFERRARE INTESTINI, ALLIS.....	537	PINZA PER BIOPSIA, SCHUBERT .....	588	PINZA PER MEDICATURA, SIMS-MAIER.....	134
PINZA PER AFFERRARE INTESTINI, ALLIS-ADAIR.....	537	PINZA PER BIOPSIA, THOMAS-GAYLOR .....	588	PINZA PER MEDICATURA, ULRICH .....	135
PINZA PER AFFERRARE INTESTINI, ALLIS-BABY.....	537	PINZA PER BIOPSIA, TISCHLER.....	591	PINZA PER MICROCHIRURGIA.....	94
PINZA PER AFFERRARE INTESTINI, ATRAUMA.....	111	PINZA PER BIOPSIA, TISCHLER-KEVORK.....	592	PINZA PER OCCLUSIONE TANGENZIALE, DEBAKEY-SATINSKY .....	502
PINZA PER AFFERRARE INTESTINI, BABCOCK.....	539	PINZA PER BIOPSIA, TISCHLER-MORGAN .....	590, 591	PINZA PER OSSA LAMBERT-LOWMAN.....	249
PINZA PER AFFERRARE INTESTINI, COLLIN.....	539	PINZA PER BIOPSIA, VAN DOREN .....	588	PINZA PER OSSA, FELDHEIM.....	249
PINZA PER AFFERRARE INTESTINI, DOYEN.....	539	PINZA PER BIOPSIA, WITNER.....	589	PINZA PER OSSA, GERSTER.....	250
PINZA PER AFFERRARE INTESTINI, JUDD-ALLIS.....	538	PINZA PER BIOPSIA, TISCHLER-MORGAN .....	590	PINZA PER OSSA, LOWMAN.....	249
PINZA PER AFFERRARE INTESTINI, LITTLEWOOD.....	538	PINZA PER BRONCHI, FINOCCHIETTO .....	490	PINZA PER OSSA, LOWMAN-HOGLUND.....	249
PINZA PER AFFERRARE INTESTINI, THOMS-ALLIS.....	538	PINZA PER BRONCHI, HARRINGTON.....	490	PINZA PER PATELLA.....	248
PINZA PER AFFERRARE INTESTINI, WILLIAMS.....	539	PINZA PER BRONCHI, LEES.....	504	PINZA PER PEDUNCOLO RENALE, HERRICK.....	123
PINZA PER AFFERRARE L'UTERO, COLLIN.....	585	PINZA PER BRONCHI, PRICE-THOMAS .....	490	PINZA PER PEDUNCOLO RENALE, WERTHEIM-CULLEN .....	125
PINZA PER AFFERRARE L'UTERO, DARTIGUES.....	585	PINZA PER BRONCHI, SEMB .....	491	PINZA PER PILORO, BENSON.....	544
PINZA PER AFFERRARE L'UTERO, SOMER.....	585	PINZA PER BRONCO-ESOFAGOSCOPIA, CHEVALIER-JACK.....	473	PINZA PER POLIPI LARINGEI FRAENKEL.....	471
PINZA PER AFFERRARE TENDINI.....	293	PINZA PER CALAZIO, AYER.....	393	PINZA PER POLIPI LARINGEI JURASZ.....	471
PINZA PER AFFERRARE TENDINI JACKSON .....	292	PINZA PER CALAZIO, DESMARES.....	393	PINZA PER POLIPI LARINGEI, JACKSON.....	471
PINZA PER AFFERRARE TENDINI KLEINERT-KUTZ.....	294	PINZA PER CALAZIO, LAMBERT .....	393	PINZA PER POLIPI UTERINI, DOYEN.....	585
PINZA PER AFFERRARE TENDINI, BRAND.....	293	PINZA PER CALCOLI BILIARI BLAKE .....	531	PINZA PER POLIPI UTERINI, KELLY .....	585
PINZA PER AFFERRARE TENDINI, CAROLL.....	293	PINZA PER CALCOLI BILIARI DESJARDINS .....	531	PINZA PER POLIPI UTERINI, NOTO.....	585
PINZA PER AFFERRARE TENDINI, LARSEN.....	292	PINZA PER CALCOLI BILIARI MAYO-BLAKE .....	531	PINZA PER POLIPI, HARTMANN.....	424
PINZA PER AFFERRARE TENDINI, STEINMANN.....	292	PINZA PER CALCOLI BILIARI MIXTER .....	531	PINZA PER POLIPI, LITTAUER .....	425
PINZA PER AFFERRARE TESSUTI, BROWN.....	83	PINZA PER CALCOLI RENALI, HEIMING.....	536	PINZA PER POLIPI, NOYES.....	425
PINZA PER AFFERRARE TESSUTI, CHAPUT .....	110	PINZA PER CALCOLI RENALI, RANDALL.....	535	PINZA PER RADDRIZZARE IL SETTO NASALE, ASCH.....	449
PINZA PER AFFERRARE TESSUTI, COLLIN.....	110	PINZA PER CAROTIDE JAVID .....	511	PINZA PER RADDRIZZARE IL SETTO NASALE, WALSHAM .....	449
PINZA PER AFFERRARE TESSUTI, SINGLEY.....	88	PINZA PER CATETERI COOLEY .....	510	PINZA PER RIFIUTI SAUERBRUCH .....	227
PINZA PER AFFERRARE TESSUTI, TUFFIER.....	110	PINZA PER COARTAZIONE E ANASTOMOSI POTTS .....	492, 493	PINZA PER RIPOSIZIONE, ROWE.....	459
PINZA PER AGRAFES, CHILDE.....	224	PINZA PER CORPI ESTRANEI STRUEMPEL .....	412	PINZA PER ROVESCARE PALPEBRE, SNELLEN.....	393
PINZA PER AGRAFES, COLLIN.....	224	PINZA PER CORPI ESTRANEI, MATHIEU .....	553/1	PINZA PER SCHEGGE.....	91
PINZA PER AGRAFES, HEGENBARTH.....	224	PINZA PER CRANIOTOMIA CONE.....	331	PINZA PER SCHEGGE, ARCHER .....	92
PINZA PER AGRAFES, MICHEL.....	224	PINZA PER EMORROIDI, HEYWOOD-SMITH .....	567	PINZA PER SCHEGGE, CARMALT.....	91
PINZA PER AGRAFES, WACHENFELDT.....	224	PINZA PER FILO, MCPHERSON .....	392	PINZA PER SCHEGGE, FELCHENFELD.....	91
		PINZA PER FILO, MOD. TUEBINGEN .....	392	PINZA PER SCHEGGE, HUNTER .....	91
		PINZA PER FILO, PAUFIQUE.....	392	PINZA PER SCHEGGE, PEET.....	92
		PINZA PER FILO, LAHEY.....	479	PINZA PER SCHEGGE, VIRTUS (RALK).....	92
		PINZA PER IL CUIOIO CAPELLUTO, GAUSS.....	605	PINZA PER SCHEGGE, STIEGLITZ.....	92
		PINZA PER INTRODUZIONE SONDE MAGILL.....	28	PINZA PER SETTO NASALE, BRUENINGS.....	425
		PINZA PER IPOFISI.....	341	PINZA PER SETTO NASALE, HEYMANN.....	425
		PINZA PER IPOFISI, ADSON.....	334	PINZA PER SETTO NASALE, LUC .....	426
		PINZA PER IRIDE BARRAQUER (COLIBRI).....	384	PINZA PER SETTO NASALE, MIDDLETON-JANSEN.....	430
		PINZA PER IRIDE, BARRAQUER-KATZIN .....	384	PINZA PER SETTO NASALE, RUBIN.....	428
		PINZA PER IRIDE, BISHOP-HARMAN.....	386	PINZA PER SINUSCOPIA.....	431
		PINZA PER IRIDE, BONN.....	387	PINZA PER STERILIZZAZIONE.....	227
		PINZA PER IRIDE, FISCHER.....	384	PINZA PER STERILIZZAZIONE DAVIS .....	227
		PINZA PER IRIDE, FOERSTER .....	383	PINZA PER STERILIZZAZIONE, CHEATLE .....	227
		PINZA PER IRIDE, GILL.....	384	PINZA PER STERILIZZAZIONE, ROGGE.....	227
		PINZA PER IRIDE, GILL-HESS .....	384		





PINZA PER STERILIZZAZIONE, UNIVERSAL.....	227	PINZA TAGLIENTE PER DISCHI INTERVERTEBRALI, FERRIS-SMITH-KERRISON.....	344, 344/2	PORT'AGHI, DE BAKEY.....	210
PINZA PER STRABISMO, BONACCOLTO.....	385	PINZA TAGLIENTE PER LAMINECTOMIA, CLOWARD.....	342	PORT'AGHI, DERF.....	208
PINZA PER STRABISMO, DASTOOR.....	386	PINZA TAGLIENTE PER LAMINECTOMIA, OLDBERG.....	341	PORT'AGHI, FINOCCHIETTO.....	211
PINZA PER STRABISMO, JAMESON.....	385	PINZA TAGLIENTE PER LAMINECTOMIA, SCHLESINGER.....	342	PORT'AGHI, GILLIES.....	212
PINZA PER STRABISMO, MCCULLOUGH.....	385	PINZA TAGLIENTE PER LAMINECTOMIA, SPURLING.....	340	PORT'AGHI, HALSEY.....	208
PINZA PER SUTURA, CASTROVIEJO.....	392	PINZA TAGLIENTE PER LAMINECTOMIA, WAGNER.....	343	PORT'AGHI, HALSEY.....	208
PINZA PER SUTURA, MOORFIELD.....	392	PINZA TAGLIENTE PER LAMINECTOMIA, CUSHING.....	340	PORT'AGHI, HEANEY.....	210
PINZA PER SUTURA, ST. MARTIN.....	392	PINZA TAGLIENTE PER LAMINECTOMIA, FERRIS-SMITH.....	343	PORT'AGHI, HOESEL.....	213
PINZA PER TAMPONI, BOZEMANN.....	138	PINZA TAGLIENTE PER LAMINECTOMIA, LOVE-GRUENWALD.....	340	PORT'AGHI, JOHNSON.....	215
PINZA PER TAMPONI, BOZEMANN-DOUGLAS.....	138	PINZA TAGLIENTE PER SETTO NASALE, CITELLI.....	430	PORT'AGHI, JOHNSON.....	211
PINZA PER TONSILLE COLVER.....	467	PINZA TIRALINGUA, COLLIN.....	453	PORT'AGHI, KALT-ARRUGA.....	214
PINZA PER TONSILLE, BALLENGER.....	467	PINZA TIRALINGUA, YOUNG.....	453	PORT'AGHI, KILNER.....	212
PINZA PER TONSILLE, BLOHMKE.....	467	PINZA TORCIFILI, BERRY TC.....	319	PORT'AGHI, LANGENBECK.....	213
PINZA PER TONSILLE, MARSCHIK.....	468	PINZA TORCIFILI, CORWIN-HEGAR TC.....	319	PORT'AGHI, LICHTENBERG.....	213
PINZA PER TONSILLE, NEGUS.....	467	PINZA TORCIFILI, MAYO-HABERISSER TC.....	319	PORT'AGHI, MASSON.....	210
PINZA PER TONSILLE, SAWTELL.....	467	PINZA ULTRA LIGHT.....	95	PORT'AGHI, MATHIEU.....	213
PINZA PER TONSILLE, SCHNIDT.....	467	PINZA UTERINA PER EMOSTASI, GREEN-ARMYTAGE.....	605	PORT'AGHI, MATHIEU-OLSEN.....	212
PINZA PER TONSILLE, TYDING.....	467, 468	PINZA VASCOLARE BAINBRIDGE.....	495	PORT'AGHI, MAYO-HEGAR.....	209
PINZA PER TONSILLE, WHITE.....	467	PINZA VASCOLARE GLOVER.....	515	PORT'AGHI, METZENBAUM.....	211
PINZA PER TRACOMA, KNAPP-LUER.....	393	PINZA VASCOLARE ADLERKREUTZ.....	84	PORT'AGHI, NEIVERT.....	208
PINZA PER TRAZIONE CRANIALE, CRUTCHFIELD.....	327	PINZA VASCOLARE, DIEFFENBACH.....	104	PORT'AGHI, OLSEN-HEGAR.....	212
PINZA PER TUMORI, YASARGIL.....	97	PINZA VASCOLARE, LELAND-JONES.....	494	PORT'AGHI, RYDER.....	210
PINZA PERITONEALE, FAURE.....	123	PINZA VASCOLARE, SATINSKY.....	491	PORT'AGHI, SAROT.....	211
PINZA PERITONEALE, MIKULICZ, 20CM.....	123	PINZA VASCOLARE, STILLE-BARRAYA.....	88	PORT'AGHI, STEVENS.....	214
PINZA PERITONEALE, MIKULICZ-BABY.....	123	PINZA, DAVIS.....	227	PORT'AGHI, WANGENSTEEN.....	210
PINZA PERITONEALE, PHANEUF.....	123	PINZE ATRAUMATICHE BULLDOG DE BAKEY.....	103	PORT'AGHI, WEBSTER.....	208
PINZA PORTAPLACCHE, LANE.....	325	PINZE ATRAUMATICHE BULLDOG GLOVER.....	103	PORT'AGHI, BABY-OLSEN-HEG.....	212
PINZA PORTAVITI, LANE.....	325	PINZE ATRAUMATICHE BULLDOG IN TITANIO.....	102	PORT'AGHI, STRATTE.....	212
PINZA POSA CLIPS BIEMER.....	361,363,364,366	PINZE ATRAUMATICHE, DE BAKEY.....	98	PORTATORE DI LUCE FREDDA A FIBRE DI VETRO KLEINSASSER.....	36
PINZA POSA CLIPS, MEHDORN.....	362	PINZE PER SCHEGGE.....	90	POSA CLIPS.....	357,358, 359, 360
PINZA POSA CLIPS, RANEY.....	327	PIPER FORCIPE.....	604	POSA CLIPS JOHNS-HOPKINS.....	104
PINZA RENALE GUYON.....	122	PISTOLA LAVATRICE.....	626	POSA CLIPS, MC KENZIE.....	326
PINZA SERRAPENE, STOCKMANN.....	553/1	PISTONI.....	258, 259	POSA CLIPS, SMITHWICK.....	326
PINZA SERRAPENE, STRAUSS.....	553/1	PISTONI CASPAR.....	258	POSA CLIPS, SWEET.....	326
PINZA SERRATUBI.....	129	PLACCA PER PALPEBRE JAEGER.....	371	POST MORTEM AGO.....	268
PINZA SERRATUBI, HOFFMANN.....	624	PLACCA PER STENDIPELLE.....	49	POTTS PINZA PER COARTAZIONE E ANASTOMOSI .....	492, 493
PINZA SERRATUBI, SIMPLEX.....	624	PLESTER CANNULA D'ASPIRAZIONE.....	338	POTTS SMITH PINZA CHIRURGICA.....	81
PINZA SERRATUBI, BÜLOW-GUNAR-HEY.....	130	PLESTER COLTELLO.....	418	POTTS-DE MARTEL FORBICI VASCOLARI.....	59
PINZA SFENOIDALE HAJEK-KOFLER.....	430,431	PLESTER DIVARICATORE.....	171	POTTS-SMITH FORBICI VASCOLARI.....	61
PINZA SGOBRIA BANE-HARTMANN.....	237	POLITZER AGO PER PARACENTESI.....	408	POTTS-SMITH PINZA ANATOMICA.....	81
PINZA SGOBRIA MAYFIELD.....	238	POLITZER COLTELLO AURICOLARE.....	408	PRATT DILATATORE UTERINO.....	580
PINZA SGOBRIA SMITH-PETERSEN.....	238	POLITZER INSOFFIATORE D'ARIA.....	406	PRATT PINZA DA PRESA.....	110
PINZA SGOBRIA, ADSON.....	236	POLITZER OLIVA NASALE.....	406	PRATT PINZA PER ABBASSARE IL COLLO DELL'UTERO.....	584
PINZA SGOBRIA, BLUMENTHAL.....	236	POLITZER SPECOLO AURICOLARE.....	399	PRATT SPECILLO PER FISTOLE.....	563
PINZA SGOBRIA, BOEHLER.....	238	POMPA D'ARIA.....	295	PRATT SPECILO RETTALE.....	559
PINZA SGOBRIA, CLEVELAND.....	235	POOLE CANNULA D'ASPIRAZIONE.....	27	PRECISA SFIGMOMANOMETRO.....	9
PINZA SGOBRIA, ECHLIN.....	240	PORTA AGRAFES.....	326	PRICE-THOMAS PINZA PER BRONCHI.....	490
PINZA SGOBRIA, FRIEDMAN-MICRO.....	234	PORTACOTONE, FARRELL.....	203	PRINCE FORBICI PER TONSILLE.....	59
PINZA SGOBRIA, FRIEDMAN-MINI.....	234	PORTACOTONE, JOBSON-HORNE.....	203	PRINCE PINZA MUSCOLARE.....	387
PINZA SGOBRIA, FRYKHOLM.....	240	PORTACOTONE, REDA.....	203	PROTEGGIDITA, LANGENBECK.....	311
PINZA SGOBRIA, JANSEN.....	237	PORTACOTONE, TOBOLD.....	203	PROCTOSCOPO BENSAUDE.....	565
PINZA SGOBRIA, KLEINERT-KUTZ.....	237	PORTACOTONE, UCKERMANN.....	203	PROCTOSCOPO MORGAN.....	565
PINZA SGOBRIA, LEMPERS.....	237	PORT'AGHI BARRAQUER.....	216, 217	PROCTOSCOPO, CHELSEA-EATON.....	563
PINZA SGOBRIA, LUER.....	236	PORT'AGHI CASTROVIEJO.....	216	PROCTOSCOPO, FANSLER.....	565
PINZA SGOBRIA, MARQUARDT.....	239	PORT'AGHI MICROVASCOLARE.....	210	PROCTOSCOPO, KELLY.....	563
PINZA SGOBRIA, MEAD.....	235	PORT'AGHI, ADSON.....	211	PROVIDENCE-HOSPITAL PINZA EMOSTATICA.....	106
PINZA SGOBRIA, OLIVECRONA.....	237	PORT'AGHI, ARRUGA.....	214	PUNTE PER SPECILLI.....	201
PINZA SGOBRIA, RUSKIN.....	239	PORT'AGHI, BABY-WEBSTER.....	208	PUTTI RASPA PER OSSA.....	294
PINZA SGOBRIA, SAUERBRUCH.....	240	PORT'AGHI, BARRAQUER-TROUTMAN.....	216	Q QUERVAIN ELEVATORE.....	275
PINZA SGOBRIA, SCAGLIETTI.....	240	PORT'AGHI, BAUMGARTNER.....	208	QUINBY FORBICI GINGIVALI.....	67
PINZA SGOBRIA, SEMB.....	240	PORT'AGHI, BOYNTON.....	214	QUIRE LEVA PER CORPI ESTRANEI.....	412
PINZA SGOBRIA, STELLBRINK.....	234	PORT'AGHI, BOZEMANN.....	211	QUISLING MARTELLO.....	271
PINZA SGOBRIA, ZAUFAJ-JANSEN.....	238	PORT'AGHI, BROWN.....	209		
PINZA SGOBRIA, LEKSELL-STILLE.....	240	PORT'AGHI, CASTROVIEJO.....	215		
PINZA SGOBRIA, STILLE-LUER.....	239	PORT'AGHI, CASTROVIEJO MICRO.....	215		
PINZA SGOBRIA, STILLE-RUSKIN.....	239	PORT'AGHI, COLLIER, 12,5CM.....	208		
PINZA STOMACALE LANE.....	547	PORT'AGHI, CRILE.....	213		
PINZA STRAPPAGESSI, WOLFF.....	233	PORT'AGHI, CRILE-MURRAY.....	209		
PINZA TAGLIENTE CIRCOLARE.....	432	PORT'AGHI, CRILE-WOOD TC.....	209		
PINZA TAGLIENTE NASALE, KERRISON.....	428				
PINZA TAGLIENTE PER CAPSULA, HOLTH.....	380				
PINZA TAGLIENTE PER DISCHI INTERVERTEBRALI, COLCLOUGH.....	344/1				



<b>R</b>			
RACCORDO DI LAVAGGIO.....	626	ROBB SPATOLA.....	530
RACHOTOMO.....	267	ROBERTS PINZA EMOSTATICA.....	117
RADOLF PINZA PER LACERAZIONE UNGHIE.....	297	ROCHARD DIVARICATORE ADDOMINALE.....	186
RAGNELL DIVARICATORE.....	140	ROCHARD SUPPORTO.....	186
RALK PERFORATORE A MANO.....	300	ROCHESTER-CARMALT.....	109
RAMPLEY PINZA PER MEDICATURA.....	136	ROCHESTER-OCHSNER PINZA EMOSTATICA.....	108
RAMUS DIVARICATORE.....	461	ROCHESTER-PEAN PINZA EMOSTATICA.....	108
RANDALL CURETTA PER BIOPSIA.....	587	ROEDER PINZA FISSATELI.....	132
RANDALL PINZA PER CALCOLI RENALI.....	535	ROGER ELEVATORE PER SETTO.....	437, 438
RANEY GRAFFA PER IL CUOIO CAPELLUTO.....	327	ROGERS PINZA PER ISTERECTOMIA.....	127
RANEY PINZA POSA CLIPS.....	327	ROGGE PINZA PER STERILIZZAZIONE.....	227
RASCHIATOIO CORNEALE, KUHN.....	373	ROLLET SCALPELLO ESTIRPATORE.....	374
RASOIO.....	49	ROLLET UNCINO DIVARICATORE.....	375
RASPA NASALE FOMON TC.....	445	ROMPILAMETTE, CASTROVIEJO.....	45
RASPA NASALE GALLAHER.....	446	ROMPILAMETTE, REDA.....	45
RASPA NASALE MILLER.....	444	ROMPILAMETTE, TROUTMAN-CHRIS.....	45
RASPA NASALE PEET.....	446	ROSE DIVARICATORE.....	140
RASPA NASALE, FOMON.....	444	ROSEN AGO.....	419
RASPA NASALE, JOSEPH.....	443	ROSEN CANNULA D'ASPIRAZIONE.....	338
RASPA NASALE, JOSEPH (LEWIS).....	443	ROSEN COLTELLO.....	418
RASPA NASALE, MALTZ.....	443	ROSER-KOENIG APRIBOCCA.....	454
RASPA NASALE, MALTZ (COTTLE).....	444	ROTATORE PER NUCLEO BECHERT.....	379
RASPA NASALE, WIENER.....	443	ROUX MINI DIVARICATORE.....	140
RASPA PER OSSA.....	294	ROUX DIVARICATORE.....	139
RASPA PER OSSA PUTTI.....	294	ROUX-BABY DIVARICATORE.....	140
RECAMIER CURETTE UTERINI.....	597	ROWE PINZA PER RIPOSIZIONE.....	459
RECIPIENTE CILINDRICO.....	620	RUBIN OSTEOTOMO PER SETTO.....	440
REDA DIAPASON.....	403	RUBIN PINZA PER SETTO NASALE.....	428
REDA CALAMITA OCULISTICA.....	395	RUDD LEGATORE EMORROIDALE.....	568
REDA COLTELLO FALCATO.....	435	RUMEL PINZA EMOSTATICA.....	117
REDA COLTELLO PER AMPUTAZIONE.....	44	RUMEL-BELMONT TOURNIQUET.....	528
REDA CURETTA TAGLIANTE.....	256	RUSKIN PINZA SGORBIA.....	239
REDA DIVARICATORE PER GESSI.....	232	RUSKIN-LISTON CESOIA PER OSSA.....	241
REDA EXCENTER FORBICI PER BENDAGGI.....	69/2	RUSSEL-DAVIS ABBASSALINGUA.....	458
REDA PERFORATORE A MANO.....	300	RYDEL-SEIFFERT DIAPASON.....	404
REDA PINZA COPERCHIO.....	615	RYDER PORT'AGHI.....	210
REDA PINZA DEPILATORIA.....	395		
REDA PINZA PER AFFERRARE INTESTINI.....	111	<b>S</b>	
REDA PORTACOTONE.....	203	SAALFELD SCHIACCIACOMEDONI.....	608
REDA ROMPILAMETTE.....	45	SACHS DURA DISSETTORE.....	332
REDA SEGA TAGLIA ANELLI.....	297	SACHS UNCINO PER NERVI.....	329
REDA SONDA CONDOTTRICE A FORCHETTA.....	221	SAENGER PINZA PER ABORTO.....	606
REDA SPECOLO NASALE.....	423	SALPINGOGRAFO.SCHULTZE.....	596
REDA UNCINO PER LA PELLE.....	150	SANVENERO FORBICI PER CHIRURGIA.....	54
REDON AGO DI GUIDA.....	207	SAROT PINZA EMOSTATICA.....	118
REES FACE LIFT FORBICI.....	73	SAROT PORT'AGHI.....	211
REGOLO DI METALLO.....	25	SATINSKY FORBICI VASCOLARI.....	65/2
REICHERT DEPRESSORE PER EPIGLOTTIDE.....	471	SATINSKY PINZA VASCOLARE.....	491
REILL TENAGLIA PER OSSA.....	248	SATO DISSETTORE CORNEALE.....	373
REINER COLTELLO PER GESSI.....	233	SATTERLEE SEGA PER AMPUTAZIONE.....	296
REINER SIRINGA AURICOLARE.....	406	SAUERBRUCH COSTOTOMO.....	481
RESANO PINZA INTESTINALE.....	542	SAUERBRUCH DIVARICATORE.....	164
RESANO, FORBICI PER CAPSULA.....	53/2	SAUERBRUCH DIVARICATORE.....	166
RETRATTORE, PERCY.....	296	SAUERBRUCH PINZA PER RIFIUTI.....	227
RETRATTORI INTRAORALI.....	463/1	SAUERBRUCH PINZA SGORBIA.....	240
RETRATTORI INTRAORALI.....	463/4	SAUERBRUCH-FREY COSTOTOMO.....	481
REVERDIN AGO.....	220	SAWTELL PINZA PER TONSILLE.....	467
REVERDIN SPATOLA ADDOMINALE E INTESTINALE.....	143/1	SAWYER SPECOLO RETTALE.....	560
REYNOLDS FORBICI PER CHIRURGIA.....	54	SAYRE ELEVATORE.....	281
REYNOLDS SUPER CUT FORBICI.....	72	SCAGLIETTI PINZA SGORBIA.....	240
RIBBON SPATOLA ADDOMINALE E INTESTINALE.....	143	SCALP-CONTOUR DIVARICATORE.....	169
RICARD DIVARICATORE ADDOMINALE.....	191	SCALPELLI.....	259
RICHARDSON DIVARICATORE.....	142	SCALPELLO ESTIRPATORE, ROLLET.....	374
RICHARDSON-EASTMAN DIVARICATORE.....	142	SCALPELLO PARTSCH.....	259
RICHARDSON-GRIP DIVARICATORE.....	142	SCALPELLO PER SETTO, CINELLI.....	441
RICHNAU-HOLMGREN SPECOLO AURICOLARE.....	400	SCALPELLO PER SETTO, COTTLE.....	440
RICHTER-HEATH PINZA PER AGRAFES.....	224	SCALPELLO PER SETTO, FREER.....	439
RIENHOFF-FINOCHIETTO DIVARICATORE COSTALE.....	486	SCALPELLO PER SETTO, SILVER.....	442
RIGBY DIVARICATORE ADDOMINALE.....	189/2	SCALPELLO, ALEXANDER.....	259
RI-MINI COMBINAZIONE PER DIAGNOSTICA		SCALPELLO, BRUNETTI.....	268
CON ILLUMINAZIONE ALOGENA.....	17	SCALPELLO, HIBBS.....	265
BITTER-HALLE DILATATORE PER SENO FRONTALE.....	433	SCALPELLO, STILLE.....	260
		SCATOLA PER STERILIZZARE AGHI.....	615
		SCATOLA PER STRUMENTI.....	616, 617, 618
		SCHAEDEL PINZA FISSATELI.....	132
		SCHAMBERG SCHIACCIACOMEDONI.....	608
		SCHAEDE CURETTA TAGLIANTE.....	251
		SCHIEE COLTELLO PER GONIO TOMIA.....	373
		SCHNEIMANN INSERTO.....	472
		SCHERBAK SPECOLO VAGINALE.....	575
		SCHIACCIACOMEDONI, SAALFELD.....	608
		SCHIACCIACOMEDONI, SCHAMBERG.....	608
		SCHIACCIACOMEDONI, UNNA.....	608
		SCHIACCIACOMEDONI, WALTON.....	608
		SCHIACCIATORE PER L'INTESTINO E LO STOMACO, PAYR.....	548
		SCHIMMELBUSCH TAMBURO.....	622
		SCHINK DERMATOMO.....	49
		SCHIOETZ TONOMETRO.....	394/2
		SCHLESINGER PINZA TAGLIANTE PER LAMINECTOMIA.....	342
		SCHMEDEN PINZA NASALE.....	427
		SCHMID CANNULA PER IRRIGAZIONE.....	338
		SCHMIEDEN SPECILLO DI GUIDA SCANALATO.....	221
		SCHMIEDEN-DICK AGO PER LEGATURE.....	219
		SCHMIEDEN-TAYLOR FORBICI PER DURAMADRE.....	65/1
		SCHNIDT PINZA PER TONSILLE.....	467
		SCHOENBORN DIVARICATORE PER TIROIDE.....	479
		SCHROEDER CUCCHIAIO UTERINO.....	595
		SCHROEDER(POZZI) PINZA PER ABBASSARE IL COLLO DELL'UTERO.....	582
		SCHUBERT PINZA PER BIOPSIA.....	588
		SCHUKNECHT COLTELLO.....	418
		SCHULTZE SALPINGOGRAFO.....	596
		SCHULZE-BERGMANN SPECOLO RETTALE.....	560
		SCHUMACHER FORBICI PER STERNO.....	481
		SCHUMACHER INSERTO.....	472
		SCHUMACHER PINZA PER BIOPSIA.....	588, 589
		SCHWEIGGER PINZA CAPSULARE.....	391
		SCLEROTOMO, GUYTON-LUNDGAARD.....	373
		SCLEROTOMO, LUNDGAARD.....	373
		SCOVILLE CURETTA TAGLIANTE.....	253
		SCOVILLE DIVARICATORE PER LAMINECTOMIA.....	196
		SCOVILLE UNCINI PER RADICI DEI NERVI.....	330
		SCOVILLE VALVE.....	196
		SCOVILLE-HAVERFIELD DIVARICATORE PER LAMINECTOMIA.....	196
		SCUDDER PINZA INTESTINALE.....	541
		SEBILAU ELEVATORE.....	275
		SEDLITT PERIOTOTOMO.....	274, 275
		SEGA , GIGLI.....	332
		SEGA ELETTRICA PER GESSI.....	230
		SEGA IN FILO D'ACCIAIO, OLIVECRONA.....	332
		SEGA NASALE , JOSEPH.....	446
		SEGA OSCILLANTE PER GESSI CON ASPIRAZIONE.....	231
		SEGA PER AMPUTAZIONE BIER.....	296
		SEGA PER AMPUTAZIONE, CHARRIERE.....	296
		SEGA PER AMPUTAZIONE, SATTERLEE.....	296
		SEGA PER AUTOPSIA.....	231/1
		SEGA PER DITA, LANGENBECK.....	296
		SEGA PER GESSI, ENGEL.....	229
		SEGA TAGLIA ANELLI, REDA.....	297
		SEGA TAGLIA ANELLI, WALTON.....	297
		SEGOND BISTURI PER FIBROMI.....	594
		SEGOND PINZA PER ISTERECTOMIA.....	125
		SEGOND-LANDAU PINZA PER ISTERECTOMIA.....	125
		SEIFERT INSERTO.....	472
		SELDIN PERIOTOTOMO.....	277
		SELLHEIM CUCCHIAIO OSTETRICO.....	607
		SEMB CESOIA PER OSSA.....	242
		SEMB PERIOTOTOMO.....	278
		SEMB PINZA PER BRONCHI.....	491
		SEMB PINZA SGORBIA.....	240
		SEMB TENAGLIA PER OSSA.....	243
		SEMKEN PINZA ANATOMICA.....	86



SEMKEN PINZA CHIRURGICA.....	86	SINGLEY PINZA PER AFFERRARE TESSUTI.....	88	SPECILLO DI GUIDA SCANALATO, SCHMIEDEN.....	221
SEMM SPECOLO VAGINALE.....	571	SINSKEY UNCINO.....	376	SPECILLO DI GUIDA, VIENNA.....	221
SENN-GREEN DIVARICATORE.....	153	SINUS ELEVATORE PER SETTO.....	438	SPECILLO FOGLIA MIRTE.....	199
SENN-MILLER DIVARICATORE.....	143	SIRINGA AURICOLARE.....	407	SPECILLO PER CANALE LACRIMALE BOWMAN.....	381
SEPERATORE PER IL CORPO MANDIBOLARE HARGIS.....	463/6	SIRINGA AURICOLARE, REINER.....	406	SPECILLO PER FISTOLE LOCKHART-MUMMERY.....	200
SEPERATORI SAGITTALI SMITH.....	463/5	SIRINGA PER TONSILLE.....	470	SPECILLO PER FISTOLE, PRATT.....	563
SEPTEMZANGE KNIGHT.....	425	SISTEMA DI FISSAGGIO, LEYLA.....	368, 368/1, 368/2, 368/3, 368/4	SPECILLO SCANALATO.....	199
SERPENTINE PINZA PER BIOPSIA.....	593	SISTEMA RETRATTORE.....	188	SPECILLO SCANALATO, BRODIE.....	199
SERRANODI PER TONSILLE, BRUENINGS.....	468	SKENE PINZA PER ABBASSARE IL COLLO.....		SPECILLO SCANALATO, DOYEN.....	199
SERRANODI PER TONSILLE, EVES.....	468	DELL'UTERO.....	582	SPECILLO SCANALATO, NELATON.....	199
SERRANODI RETTALE, WESTON.....	566	SLS PINZA APPLICATORE CLIPS MICRO.....	524, 525	SPECILLO, FISH.....	199
SERRANODI WILDE.....	433/2	SLUDER-BALLENGER TONSILLOTOMO.....	470	SPECILLO, WATSON-CHEYNE.....	199
SET LARINGOSCOPIO FOREGGER.....	31	SMELLIE PERFORATORE.....	607	SPECOLO AURICOLARE RICHNAU-HOLMGREN.....	400
SET LARINGOSCOPIO MC INTOSH.....	31	SMELLIE UNCINO.....	605	SPECOLO AURICOLARE, BOUCHERON.....	399
SET PER INFERMERIA.....	609	SMILLIE COLTELLO PER MENISCO.....	292	SPECOLO AURICOLARE, BRUENINGS.....	401
SET PER SUTURA IN ASTUCCIO DI METALLO.....	225, 226	SMILLIE ELEVATORE PER OSSA.....	291	SPECOLO AURICOLARE, GRUBER.....	399
SET PER TRACHEOTOMIA.....	478	SMITH BLEFAROSTATO.....	370	SPECOLO AURICOLARE, HARTMANN.....	399
SET PER VARICI IN SCATOLA DI METALLO, NABATOFF.....	201	SMITH SEPARATORI SAGITTALI.....	463/5	SPECOLO AURICOLARE, POLITZER.....	399
SEUTIN FORBICI PER BENDAGGI.....	69/2	SMITH US ARMY FORBICI PER BENDAGGI.....	69/1	SPECOLO AURICOLARE, SIEGLE.....	402
SEXTON COLTELLO AURICOLARE.....	408	SMITH-BUIE DIVARICATORE ANALE.....	561	SPECOLO AURICOLARE, TOYNBEE.....	399
SFIGMOMANOMETRO, BABYPHON.....	10	SMITH-PETERSEN DIVARICATORE ANALE.....	261	SPECOLO LATERALE.....	569
SFIGMOMANOMETRO, DIPLOMAT.....	5	SMITH-PETERSEN OSTEOTOMO.....	238	SPECOLO NASALE HARTMANN.....	422
SFIGMOMANOMETRO, EXACTA.....	8	SMITH-PETERSEN PINZA SGORBIA.....	238	SPECOLO NASALE REDA.....	423
SFIGMOMANOMETRO, MINIMUS II.....	11	SMITHWICK PINZA POSA CLIPS.....	326	SPECOLO NASALE, COTTLE.....	423
SFIGMOMANOMETRO, MINIMUS III.....	12	SMITHWICK UNCINO PER NERVI.....	329	SPECOLO NASALE, HARTMANN-HALLE.....	421
SFIGMOMANOMETRO, NOVA.....	6.7	SNELLEN ANSA PER CATERATA.....	378	SPECOLO NASALE, KILLIAN.....	423
SFIGMOMANOMETRO, PRECISA.....	9	SNELLEN PINZA PER ROVESCIARE PALPEBRE.....	393	SPECOLO NASALE, MOD.VIENNA.....	421
SGORBIA.....	264	SOMER PINZA PER AFFERRARE L'UTERO.....	585	SPECOLO NASALE, THUDICHUM.....	421
SGORBIA, PARTSCH.....	259	SONDA BOTTUNUTA, JACOBSON.....	335	SPECOLO NASALE, TIECK-HALLE.....	423
SGORBIA ALEXANDER.....	259	SONDA CONDUITTRICE A FORCHETTA.....	475	SPECOLO NASALE, VOLTOLINI.....	421
SGORBIA BRÜNINGS-LUCAS.....	260	SONDA CONDUITTRICE A FORCHETTA REDA.....	221	SPECOLO RETTALE HILL-FERGUSON.....	560
SGORBIA KILLIAN.....	442/1	SONDA PER CALCOLI BILIARI DESJARDINS.....	532	SPECOLO RETTALE SAWYER.....	560
SGORBIA PER CORPI ESTRANEI, DIX.....	374	SONDA PER CALCOLI BILIARI MOYNIHAN.....	532	SPECOLO RETTALE, ALAN-PARKS.....	561
SGORBIA PER CORPI ESTRANEI, ELLIS.....	374	SONDA PER CALCOLI BILIARI, MAYO.....	534	SPECOLO RETTALE, BARR.....	559
SGORBIA PER CORPI ESTRANEI, WALTON.....	374	SONDA PER GOZZO, KOCHER.....	479	SPECOLO RETTALE, BODENHAMMER.....	559
SGORBIA PER SETTO FREER.....	442/1	SONDA, WORST.....	381	SPECOLO RETTALE, CZERNY.....	559
SGORBIA PER SETTO, HAJEK.....	442/1	SONDA, WORST.....	381	SPECOLO RETTALE, MATHIEU.....	560
SGORBIA PER SETTO, KILLIAN-CLAUS.....	442/1	SPATOLA ADDOMINALE.....	144	SPECOLO RETTALE, PRATT.....	559
SGORBIA WEST.....	442/1	SPATOLA ADDOMINALE E INTESTINALE LERICHE.....	143/2	SPECOLO RETTALE, SIMS.....	559
SGORBIA, COBB.....	262	SPATOLA ADDOMINALE E INTESTINALE, HABERER.....	143/1	SPECOLO RETTALE, SCHULZE-BERG.....	560
SGORBIA, HIBBS.....	265	SPATOLA ADDOMINALE E INTESTINALE, REVERDIN.....	143/1	SPECOLO VAGINALE, JACKSON.....	573
SGORBIA, LEXER MINI.....	263	SPATOLA ADDOMINALE E INTESTINALE, RIBBON.....	143	SPECOLO VAGINALE, AUWARD.....	576
SGORBIA, ZIELKE.....	264	SPATOLA ADDOMINALE ED INTESTINALE KADER.....	143/1	SPECOLO VAGINALE, BREISKY.....	577
SGORBIA, STILLE.....	260	SPATOLA ADDOMINALE ED INTESTINALE KÖRTE.....	143/1	SPECOLO VAGINALE, COLLIN.....	570
SGORBI.....	259	SPATOLA ADDOMINALE ED INTESTINALE KÜMMEL.....	143/2	SPECOLO VAGINALE, CUSCO.....	570, 571
SHAMBAUGH UNCINO.....	419	SPATOLA CEREBRALE CUSHING.....	369	SPECOLO VAGINALE, DOYEN.....	574
SHAPLEIGH ANSA AURICOLARE.....	410	SPATOLA CEREBRALE DAVIS.....	337	SPECOLO VAGINALE, FRIEDMANN.....	577
SHEA MICRO FORBICI AURICOLARI.....	413	SPATOLA CEREBRALE HEIFETZ.....	369	SPECOLO VAGINALE, GRAVE.....	570
SHEEHAN OSTEOTOMO PER SETTO.....	441	SPATOLA CEREBRALE, CUSHING.....	336	SPECOLO VAGINALE, KALLMORGEN.....	573
SHEETS CANNULA PER IRRIGAZIONE.....	394/2	SPATOLA CEREBRALE, OLIVECRONA.....	336	SPECOLO VAGINALE, KRISTELLER.....	572
SIEBENMANN CANNULA PER IRRIGAZIONE.....	433	SPATOLA PER CICLODIALISI HIRSCHMAN.....	379	SPECOLO VAGINALE, LANDAU.....	577
SIEBOLD FORBICI GINECOLOGICHE.....	62	SPATOLA PER CICLODIALISI, BANGERTER.....	379	SPECOLO VAGINALE, O'SULLIVAN-O'CONNOR.....	576
SIEGLE SPECOLO AURICOLARE.....	402	SPATOLA PER CICLODIALISI, ELSCHNIG.....	379	SPECOLO VAGINALE, PEDERSON.....	570
SILVER DERMATOMO.....	50	SPATOLA PER CICLODIALISI, WHEELER.....	379	SPECOLO VAGINALE, SEMM.....	571
SILVER SCALPELLO PER SETTO.....	442	SPATOLA PER CICLODIALISI, CASTROVIEJO.....	379	SPECOLO VAGINALE, SIMS.....	573
SIMCOE CANNULA PER IRRIGAZIONE.....	394	SPATOLA PER IRIDE, CULLER.....	378	SPECOLO VAGINALE, TRELAT.....	571
SIMON CUCCHIAIO UTERINO.....	594	SPATOLA PER IRIDE, WECKER.....	378	SPECOLO VAGINALE, VU-MORE.....	569
SIMON DIVARICATORE.....	164	SPATOLA PER PEDICURE.....	612	SPECOLO VAGINALE, SCHERBAK.....	575
SIMPLEX PINZA SERRATUBI.....	624	SPATOLA PER POLMONE, ALLISON.....	489	SPENCER FORBICI PER LEGATURE.....	66
SIMPSON FORCIPE.....	602	SPATOLA ROBB.....	530	SPENCER-WELLS PINZA EMOSTATICA.....	109
SIMPSON-BRAUN FORCIPE.....	602	SPATOLA VESCICALE, KOCHER.....	552	SPIZZATORE UNGHIE.....	612/1
SIMPSON-LUIKART FORCIPE.....	603	SPATOLA VESCICALE, LEGUEU.....	552	SPILLONE PER STERILIZZAZIONE, BUNT.....	227
SIMS CURETTE UTERINI.....	597, 598	SPAZZOLA PER UNGHIE.....	611	SPILLONE PER STERILIZZAZIONE, MAYO.....	227
SIMS DEPRESSORE UTERINO.....	586	SPECCHIO FRONTALE ZIEGLER.....	21	SPINAL CURETTA TAGLIANTE.....	253
SIMS DILATATORE UTERINO.....	581	SPECCHIO LARINGEO.....	473	SPINA-NASALIS DIVARICATORE.....	461
SIMS FORBICI GINECOLOGICHE.....	62	SPECCHIO LARINGEO, MICHEL.....	423	SPRATT CURETTA TAGLIANTE.....	251
SIMS ISTEROMETRO.....	586	SPECILLO AURICALE, STACKE.....	199	SPECIAL PINZA TAGLIANTE PER LAMINECTOMIA.....	340
SIMS SPECOLO RETTALE.....	559	SPECILLO DI GUIDA SCANALATO KÖNIG.....	221	SPUTACCHIERA.....	621
SIMS SPECOLO VAGINALE.....	573	SPECILLO DI GUIDA SCANALATO BRUNNER.....	221	ST.CLAIR-THOMSON COLTELLO ADENOIDE.....	450
SIMS-MAIER PINZA PER MEDICATURA.....	134	SPECILLO DI GUIDA SCANALATO KIRSCHNER.....	221	ST.MARKS DIVARICATORE PELVICO.....	165
		SPECILLO DI GUIDA SCANALATO SCHMIEDEN-PAYR.....	221	ST.MARTIN PINZA PER SUTURA.....	392
		SPECILLO DI GUIDA SCANALATO, BRUNNER.....	221	STACKE SPECILLO AURICALE.....	199
		SPECILLO DI GUIDA SCANALATO, PAYR.....	221	STANDARD FORBICI PER CHIRURGIA.....	51



STAUDE-MOORE PINZA PER ABBASSARE IL COLLO .....		T		TOWNSEND MANICO SOLO .....	591
DELL'UTERO .....	582	TABB COLTELLO .....	418	TOYNBEE SPECOLO AURICOLARE .....	399
STEINMANN CHIODI .....	307, 308	TAKAHASHI PINZA NASALE .....	427	TRASFORMATORE RICARICA BATTERIA .....	34
STEINMANN PINZA PER AFFERRARE TENDINI .....	292	TAMBURO, SCHIMMELBUSCH .....	622	TRATTORE, BARTON .....	603
STELLBRINK PINZA SGORBIA .....	234	TAMPONATORE „LUNIATSCHKEK .....	465	TRATTORE, BILL .....	604
STERNBERG DIVARICATORE PER GUANCE .....	453	TARNIER CRANIOCLASTO .....	607	TRATTORE, LUIKART-BILL .....	604
SCALPELLO PER STERNO, LEBSCH .....	267	TARNIER FORCIPE .....	604	TRAVERS DIVARICATORE .....	172
STETOSCOPIO, ANESTOPHON .....	23	TAYLOR - USA MARTELLO DA PERCUSSIONE .....	24	TREFINA CUTANEA, KEYES .....	608
STETOSCOPIO, DUPLEX .....	23	TAYLOR DIVARICATORE SPINALE .....	291	TRELAT SPECOLO VAGINALE .....	571
STETOSCOPIO, PINARD .....	23	TAYLOR PINZA CHIRURGICA .....	87	TREQUARTO PER SENO MASCELLARE, COAKLEY .....	204
STETOSCOPIO .....	23	TC FORBICI PER CHIRURGIA FINE, REYNOLDS TC .....	54	TREQUARTO PER SENO MASCELLARE, LICHTWITZ .....	204
STEVENS FORBICI PER OFTALMOLOGIA .....	58	TC FORBICI PER CHIRURGIA STANDARD .....	51	TREQUARTO PER SENO MASCELLARE, PIERCE .....	204
STEVENS PINZA PER IRIDE .....	383	TC PINZA ANATOMICA .....	81	TREQUARTO PER SINOSCOPIA .....	205
STEVENS PORT'AGHI .....	214	TC PINZA CHIRURGICA .....	81	TREQUARTO PER SINOSCOPIA .....	205
STEVENS SUPERCUT FORBICI .....	72	TC PINZA CUSHING .....	83	TREQUARTO, NELSON .....	205
STEVENS UNCINO PER TENOTOMIA .....	375	TC PINZA CUSHING TAYLOR .....	87	TREQUARTO, OCHSNER .....	205
STEVENSON BLEFAROSTATO .....	371	TC PINZA GILLIES .....	86	TREQUARTO, UNIVERSAL .....	204
STIEGLITZ PINZA PER SCHEGGE .....	92	TC PINZA SEMKEN .....	86	TREQUARTO, STANDARD (NELSON) .....	204
STILLE CESOIA PER GESSI .....	229	TC PINZA WANGENSTEEN .....	89	TROELTSCH PINZA AURICOLARE .....	424
STILLE COSTOTOMO .....	480	TEALE PINZA PER ABBASSARE IL COLLO		TROEMNER PERCUSSIONSMARTELLO .....	24
STILLE OSTEOTOMO .....	260	DELL'UTERO .....	583	TRONCHESINA PER PELLE .....	610
STILLE PERFORATORE A MANO .....	298	TEBBETS DIVARICATORE PER CHIRURGIA PLASTICA .....	197	TRONCHESINA PER UNGHIE .....	612/1, 613
STILLE PINZA ANATOMICA .....	81	TELAIO PIEGABILE KIRSCHNER .....	187	TRONCHESINA PER UNGHIE ANVIL .....	613
STILLE PINZA CHIRURGICA .....	81/1	TENAGLIA PER OSSA .....	247	TRONCHESINA PER UNGHIE, TURNBULL .....	609
STILLE PINZA EMOSTATICA .....	122	TENAGLIA PER OSSA .....	249	TROUSSEAU DILATATORE TRACHEALE .....	476
STILLE SCALPELLO .....	260	TENAGLIA PER OSSA BIRCHER-GANSKE .....	246	TROUSSEAU-BABY DILATATORE TRACHEALE .....	476
STILLE SGORBIA .....	260	TENAGLIA PER OSSA, ADSON .....	298	TROUTMAN PINZA PER IRIDE .....	389
STILLE-BARRAYA PINZA VASCOLARE .....	88	TENAGLIA PER OSSA, DINGMANN .....	246	TROUTMAN-CHRIS ROMPLAMETTE .....	45
STILLE-HORSLEY CESOIA PER OSSA .....	242	TENAGLIA PER OSSA, FARABEUF .....	243	TUBBS DILATATORE .....	528
STILLE-LISTON CESOIA PER OSSA .....	242	TENAGLIA PER OSSA, FARABEUF-L .....	243	TUBINGEN PINZA PER FILO .....	392
STILLE-LUER PINZA SGORBIA .....	239	TENAGLIA PER OSSA, FERGUSSON .....	243	TUBO DI PROLUNGAMENTO, BRUENINGS .....	472
STILLE-RUSKIN PINZA SGORBIA .....	239	TENAGLIA PER OSSA, KERN .....	244	TUFFIER DIVARICATORE .....	147
STILLE-SHERMAN PERFORATORE A MANO .....	298	TENAGLIA PER OSSA, LAMBOTTE .....	244	TUFFIER DIVARICATORE COSTALE .....	487
STOCKMANN PINZA SERRAPENE .....	553/1	TENAGLIA PER OSSA, LANE .....	244	TUFFIER PINZA PER AFFERRARE TESSUTI .....	110
STONE-WATT COMPRESSORE .....	545	TENAGLIA PER OSSA, LANGENBECK .....	243	TURNBULL TRONCHESINA PER UNGHIE .....	609
STRANDELL-STILLE DIVARICATORE .....	157	TENAGLIA PER OSSA, LEWIN .....	246	TURREL PINZA INTESTINALE PER BIOPSIA .....	567
STRATTE PORT'AGHI .....	212	TENAGLIA PER OSSA, MARTIN .....	246	TYDING PINZA PER TONSILLE .....	467, 468
STRAUSS PINZA SERRAPENE .....	553/1	TENAGLIA PER OSSA, REILL .....	248	TYDING TONSILLOTOMO .....	469
STRUJEMPEL PINZA PER CORPI ESTRANEI .....	412	TENAGLIA PER OSSA, SEMB .....	243		
STRULLY FORBICI PER NEUROCHIRURGIA .....	65	TENAGLIA PER OSSA, ULRICH .....	248	U	
STRUMENTI PER CORPI ESTRANEI, DIX .....	380	TENAGLIA PER OSSA, VAN BUREN .....	249	UCKERMANN PORTACOTONE .....	203
STRUMENTO PER CIRCONCISIONE .....	556	TENAGLIA PER OSSA, VERBRUGGE .....	245	ULRICH PINZA PER MEDICATURA .....	135
STRUMENTO PER MISURE .....	594	TENAGLIE TAGLIAFILII .....	317, 318	ULRICH TENAGLIA PER OSSA .....	248
STRUMENTO PER VARICI VARADY .....	202	TERSON PINZA CAPSULARE .....	391	ULTRA-LIGHT-PINZA, ATRAUMATICA .....	95
STRUMENTO TENDIFILI, DEMEL .....	315	TESSIER DIVARICATORE .....	463/3	UNCINO ACUTO LAHEY .....	149
STRUMENTO TENDIFILI, LOUTE .....	315	THOMAS CURETTE UTERINI .....	599	UNCINO DI FISSAZIONE, BURCH .....	373
STRUYCKEN PINZA NASALE .....	427	THOMAS-GAYLOR PINZA PER BIOPSIA .....	588	UNCINO DIVARICATORE, KNAPP .....	375
STUOIA IN SILICONE .....	616	THOMS-ALLIS PINZA PER AFFERRARE INTESTINI .....	538	UNCINO DIVARICATORE, ROLLET .....	375
SUBRAMANIAN-MINIATURE PINZA PER AORTA		THOMSON-WALKER DIVARICATORE VESICALE .....	552	UNCINO ESTRATTORE .....	322
PEDIATRICA .....	521	THOREK, FORBICI TORACALI .....	65/2	UNCINO ESTRATTORE, ARRUGA .....	375
SUPERCUT FORBICI .....	71	THUDICHUM SPECOLO NASALE .....	421	UNCINO GALEA, YASARGIL .....	330
SUPERCUT FORBICI IRIS .....	72	TIECK-HALLE SPECOLO NASALE .....	423	UNCINO GASS .....	376
SUPERCUT FORBICI KILNER .....	72	TILLEY PINZA AURICOLARE .....	411	UNCINO KUGLEN .....	376
SUPERCUT FORBICI LISTER .....	72	TIRAMIOMI, DOYEN .....	594	UNCINO NASALE AUFRICHT .....	447
SUPERCUT FORBICI REYNOLDS .....	72	TIRAVENE .....	202	UNCINO NASALE CONVERSE .....	448
SUPERCUT FORBICI STEVENS .....	72	TISCHLER PINZA PER BIOPSIA .....	591	UNCINO NASALE UNCINO .....	447
SUPERCUT FORBICI WAGNER .....	72	TISCHLER-KEVORKIAN PINZA PER BIOPSIA .....	592	UNCINO NASALE, COTTLE .....	447
SUPERCUTFORBICI MAYO .....	71	TISCHLER-MORGAN PINZA PER BIOPSIA .....	590, 591	UNCINO NASALE, MASING-NEIVERT .....	447
SUPERCUTFORBICI MAYO-STILLE .....	71	TITAN PINZA EMOSTATICA, CRILLE, .....	107	UNCINO PER DURA MADRE, JACOBSON .....	335
SUPERCUTFORBICI METZENBAUM .....	71	TITAN PINZA EMOSTATICA, KELLY, .....	106	UNCINO PER DURAMADRE .....	335
SUPERCUTFORBICI, BABY METZENBAUM .....	71	TOBOLD ABBASSALINGUA .....	453	UNCINO PER DURAMADRE, ADSON .....	329
SUPPORTO PER PETTO NEGUS .....	459	TOBOLD PORTACOTONE .....	203	UNCINO PER FISTOLE, EMMETT .....	594
SUPPORTO PER STERILIZZAZIONE FILI KIRSCHNER .....	305	TOENNIS DURA DISSETTORE .....	332	UNCINO PER IL STRABISMO, GRAEFE .....	375
SUPPORTO PER TUBO .....	188	TOENNIS PINZA EMOSTATICA .....	117	UNCINO PER IL STRABISMO, GREEN .....	375
SUPPORTO UNIVERSALE PER DIVARICATORI .....	188	TOENNIS-ADSON FORBICI PER NEUROCHIRURGIA .....	65	UNCINO PER IL STRABISMO, JAMESON .....	375
SUPPORTO UNIVERSALE PER ENDOSCOPIO .....	188	TOGLILAMA .....	42	UNCINO PER IRIDE, O'CONNOR .....	375
SUPPORTO, ROCHARD .....	186	TOHUKU PINZA FISSATELI .....	132	UNCINO PER IRIDE, WIENER .....	375
SWEET PINZA POSA CLIPS .....	326	TONOMETRO, SCHIOETZ .....	394/2	UNCINO PER LA PELLE GRAEFE .....	149
SYSTRUNK FORBICI PER CHIRURGIA .....	66	TONSILLOTOMO, SLUDER-BALLENGER .....	470	UNCINO PER LA PELLE, COTTLE-NEIVERT .....	448
		TONSILLOTOMO, TYDING .....	469	UNCINO PER LA PELLE, FOMON .....	447/1
		TOOK DISSETTORE CORNEALE .....	373	UNCINO PER LA PELLE, FRAZIER .....	149
		TOURNIQUET RUMEL-BELMONT .....	528	UNCINO PER LA PELLE, FREER .....	448
		TOWNSEND PINZA PER BIOPSIA .....	591	UNCINO PER LA PELLE, GILLIES .....	448



UNCINO PER LA PELLE, GUTHRIE.....149  
 UNCINO PER LA PELLE, JOSEPH.....149  
 UNCINO PER LA PELLE, KILNER.....608  
 UNCINO PER LA PELLE, KLEINERT-KUTZ.....149  
 UNCINO PER LA PELLE, REDA.....150  
 UNCINO PER LE PINNE NASALI LANGE.....448  
 UNCINO PER MUSCOLI.....267  
 UNCINO PER NERVI D'ERRICO.....329/2  
 UNCINO PER NERVI, CRILE.....328  
 UNCINO PER NERVI, CUSHING.....328  
 UNCINO PER NERVI, DANDY.....328  
 UNCINO PER NERVI, GRAHAM.....329  
 UNCINO PER NERVI, HESS.....329/1  
 UNCINO PER NERVI, KRAYENBUEHL.....336  
 UNCINO PER NERVI, LOVE.....329/2  
 UNCINO PER NERVI, SACHS.....329  
 UNCINO PER NERVI, SMITHWICK.....329  
 UNCINO PER RADICI DEI NERVI, HOLLSHER.....329/1  
 UNCINO PER RADICI DEI NERVI, LOVE.....330  
 UNCINO PER RADICI DEI NERVI, SCOVILLE.....330  
 UNCINO PER TENOTOMIA, STEVENS.....375  
 UNCINO SHAMBAUGH.....419  
 UNCINO SINSKEY.....376  
 UNCINO SPEZZATORE, BRAUN.....607  
 UNCINO, BARBARA.....419  
 UNCINO, DAY.....409  
 UNCINO, FISCH.....335  
 UNCINO, LUCAE.....409  
 UNCINO, MCGEE.....419  
 UNCINO, SMELLIE.....605  
 UNCINO, WAGENER.....409  
 UNI I COMBINAZIONE PER DIAGNOSTICA CON  
 ILLUMINAZIONE STANDARD.....13  
 UNI II COMBINAZIONE PER DIAGNOSTICA CON  
 ILLUMINAZIONE STANDARD.....14  
 UNI III COMBINAZIONE PER DIAGNOSTICA CON  
 ILLUMINAZIONE STANDARD.....15  
 UNIVERSAL FORBICI PER BENDAGGI.....70  
 UNIVERSAL FORBICI PER FILO DI METALLO E LAMIERA...67  
 UNIVERSAL PINZA PER STERILIZZAZIONE.....227  
 UNIVERSAL TREQUARTO.....204  
 UNNA SCHIACCIACCOMEDONI.....608  
 URETROTOMO OTIS.....553  
 US ARMY DIVARICATORE.....141  
 USA PINZA ANATOMICA.....81

V

VACUMENTRO PER VUOTI DI SANGUE.....295  
 VALLEIX ISTEROMETRO.....586  
 VALVE CON ADATTATORI AL TELAIIO.....194  
 VALVE, SCOVILLE.....196  
 VAN BUREN CANDELETTA DILATATRICE.....554  
 VAN BUREN TENAGLIA PER OSSA.....249  
 VAN DOREN PINZA PER BIOPSIA.....588  
 VANNAS FORBICI OCULISTICHE.....79  
 VARADY STRUMENTO PER VARICI.....202  
 VASSOIO PER PASTIGLIE.....621  
 VERBRUGGE TENAGLIA PER OSSA.....245  
 VERBRUGGE-MÜLLER ELEVATORE PER OSSA.....286/2  
 VERESS AGO DI GUIDA.....206  
 VIENNA SPECILLO DI GUIDA SCANALATO.....221  
 VIRCHOW, COLTELLO PER CARTILAGINE E  
 DISSEZIONE.....48  
 VIRTUS(PALK) PINZA PER SCHEGGE.....92  
 VOLKMANN CURETTA TAGLIENTE.....251  
 VOLKMANN CURETTA TAGLIENTE.....257  
 VOLKMANN DIVARICATORE.....153  
 VOLKMANN DIVARICATORE.....154  
 VOLKMANN DIVARICATORE.....156  
 VOLTOLINI SPECOLO NASALE.....421  
 VU-MORE SPECOLO VAGINALE.....569

W

WACHENFELDT PINZA PER AGRAFES.....224  
 WADSWORTH-TODD CAUTERIO.....378  
 WAGENER-MOSHER CANNULA TRACHEALE.....477  
 WAGENR UNCINO.....409  
 WAGNER FORBICI GINGIVALI.....67  
 WAGNER PINZA TAGLIENTE PER LAMINECTOMIA.....343  
 WAGNER SUPERCUT FORBICI.....72  
 WALLICH CUCCHIAIO PER ABORTO.....607  
 WALSHAM PINZA PER RADDRIZZARE IL SETTO  
 NASALE.....449  
 WALTON SGORBIA PER CORPI ESTRANEI.....374  
 WALTON SCHIACCIACCOMEDONI.....608  
 WALTON SEGA TAGLIA ANELLI.....297  
 WANGENSTEEN PINZA VASCOLARE.....89  
 WANGENSTEEN PORT'AGHI.....210  
 WARTENBERG ALGESIMETRO.....25  
 WATSON DERMATOMO.....50  
 WATSON-CHEYNE ELEVATORE.....283  
 WATSON-CHEYNE SPECILLO.....199  
 WATSON-WILLIAMS PINZA NASALE.....428  
 WAUGH PINZA CHIRURGICA.....83  
 WEBER ANSA PER CATERATTA.....378  
 WEBER PINZA PER AORTA.....501  
 WEBSTER PORT'AGHI.....208  
 WECKER FORBICI OCULISTICHE.....75  
 WECKER SPATOLA PER IRIDE.....378  
 WEEK BLEFAROSTATO.....370  
 WEIL-BLAKESLEY PINZA NASALE.....426  
 WEITLANER DIVARICATORE.....169  
 WEITLANER-WULLSTEIN DIVARICATORE.....169  
 WELLER, FORBICI PER DISSEZIONE.....53/2  
 WELLS CUCCHIAIO PER ENUCLEAZIONE.....378  
 WERTHEIM FORBICI PER ISTERECTOMIA.....63  
 WERTHEIM PINZA PER ISTERECTOMIA.....124  
 WERTHEIM PINZA PER ISTERECTOMIA.....128  
 WERTHEIM-CULLEN PINZA PER PEDUNCOLO  
 RENALE.....125  
 WESTCOTT FORBICI OCULISTICHE.....75  
 WESTMACOTT PINZA NASALE PER TAMPONI.....424  
 WESTON SERRANODI RETTALE.....566  
 WHEELER COLTELLO LANCEOLARE.....373  
 WHEELER SPATOLA PER CICLODIALISI.....379  
 WHITE PINZA PER TONSILLE.....467  
 WIEDER ABBASSALINGUA.....452  
 WIENER RASPA NASALE.....443  
 WIENER UNCINO PER IRIDE.....375  
 WIGMORE COLTELLO PER GESSI.....229  
 WIKSTROEM PINZA EMOSTATICA.....117  
 WILDE SERRANODI.....411  
 WILDE SERRANODI.....433/2  
 WILDE(TROELTSCH) PINZA AURICOLARE.....410  
 WILDER ANSA PER CATERATTA.....378  
 WILLET MARTEL PINZA DA PRESA.....110  
 WILLIAMS BLEFAROSTATO.....370  
 WILLIAMS CACCIAVITE.....323  
 WILLIAMS PINZA PER AFFERRARE INTESTINI.....539  
 WILLIGER CURETTA TAGLIENTE.....255  
 WILLIGER MARTELLO.....271  
 WILLIGER PERIOSTOTOMO.....276  
 WINTER PINZA PER ABORTO.....606  
 WITNER PINZA PER BIOPSIA.....589  
 WOLFF PINZA STRAPPAGESSI.....233  
 WOODSON DURA DISSETTORE.....333  
 WORST, SONDA.....381  
 WRIGLEY FORCIPE.....602  
 WULLSTEIN COLTELLO.....418  
 WULLSTEIN DIVARICATORE.....171  
 WULLSTEIN MANICO D'ASPIRAZIONE.....338  
 WULLSTEIN MICRO PINZA AURICOLARE A  
 CUCCHIAIO.....416  
 WYLLIE DILATATORE UTERINO.....581

Y

YANCOSKIE DIVARICATORE PER CHIRURGIA  
 PLASTICA.....198  
 YANKAUER DISSETTORE PER TONSILLE.....465  
 YASARGIL CANNULA D'ASPIRAZIONE.....337/2  
 YASARGIL CLIPS PER ANEURISMA.....345 - 356  
 YASARGIL PINZA PER TUMORI.....97  
 YASARGIL UNCINO GALEA.....330  
 YEOMAN PINZA INTESTINALE PER BIOPSIA.....566, 567  
 YOUNG BOOMERANG PER SUTURE.....220  
 YOUNG DIVARICATORE PER LA PROSTATA.....550  
 YOUNG PINZA TIRALINGUA.....453

Z

ZAUFAL ELEVATORE AURICOLARE.....409  
 ZAUFAL-JANSEN ELEVATORE AURICOLARE.....409  
 ZAUFAL-JANSEN PINZA SGORBIA.....238  
 ZENKER DIVARICATORE.....161  
 ZENKER PINZA EMOSTATICA.....118  
 ZIEGLER BLEFAROSTATO.....371  
 ZIEGLER COLTELLO LANCEOLARE.....373  
 ZIEGLER COLTELLO PER IRIDE.....372  
 ZIEGLER DILATATORE PER CANALE LACRIMALE.....381  
 ZIEGLER SPECCHIO FRONTALE.....21  
 ZIELKE SGORBIA.....264  
 ZÖLLNER CANNULA D'ASPIRAZIONE.....337/2

Weitere Kataloge und Prospekte  
Other cataloges and prospects

Titan Instrumente  
Titanium Instruments

Container Steriltechnik  
Container Sterilization Technique

HERCULES Drahtkneifzange  
HERCULES Wire Cutters

Neurochirurgie  
Neuro Surgery

Plastische Chirurgie  
Plastic Surgery

Orthopädie  
Orthopedic



**MAST.SH-GERMANY**

**MAST.SH GERMANY**

Hejri-shojaie, Melatengurtel-10  
50933-Koln, Germany

Ph : +49 178 8888815

Fax : +49 221 25971447

Email : [sirous\\_talesh@yahoo.de](mailto:sirous_talesh@yahoo.de)

Web : [www.mast.sh-germany.com](http://www.mast.sh-germany.com)

